

**Low Noise Amplifier, 12.5 dB Gain,  
10 - 100 MHz**

**AM-/AMC-/AMS-162  
V4**

**Features**

- 1.1 dB Typical Low Noise Figure @ 50 MHz
- +15 dBm Typical High Output Power @ 50 MHz
- +32 dBm Typical Third Order Intercept @ 50 MHz
- Fully Hermetic Package (AM-162, AMS-162)

**Description**

M/A-COM's AM-162 is a coupler feedback amplifier with high intercept and compression points. The use of coupler feedback minimizes noise figure and current in a high intercept amplifier. This amplifier is packaged in a TO-8-1 package, a surface mount package and a connectorized version. The ground plane on the PC board should be configured to remove heat from under the package. AM-162 are ideally suited for use where a high intercept, high reliability amplifier is required.

**TO-8-1**

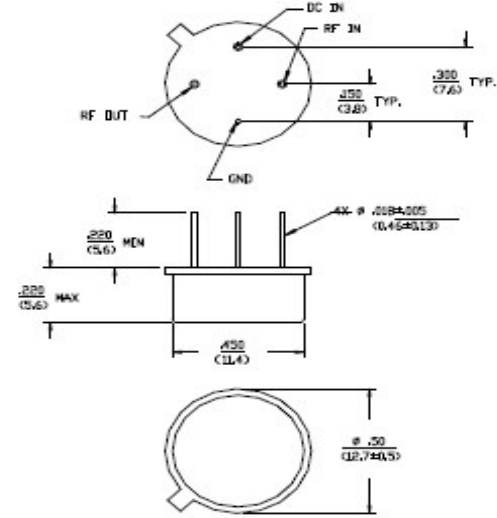

Dimensions in  $\square$  are in mm  
Unless Otherwise Noted: .00X = ±0.010 (XX = ±0.25)  
.00X = ±0.02 (XX = ±0.50)  
WEIGHT (APPROX) 0.20 OUNCES 5.6 GRAMS

**C-6**

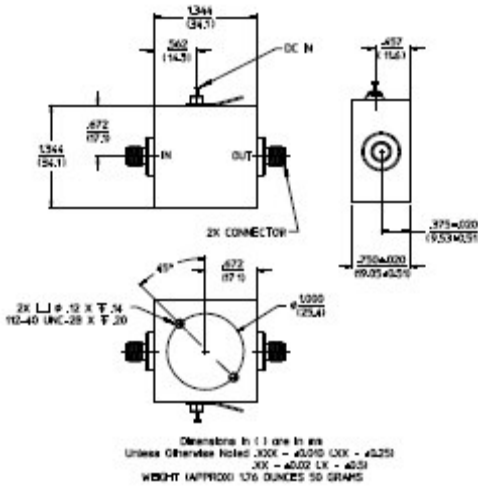

Dimensions in  $\square$  are in mm  
Unless Otherwise Noted: .00X = ±0.010 (XX = ±0.25)  
.00X = ±0.02 (XX = ±0.50)  
WEIGHT (APPROX) 0.16 OUNCES 4.5 GRAMS

**SF-1**

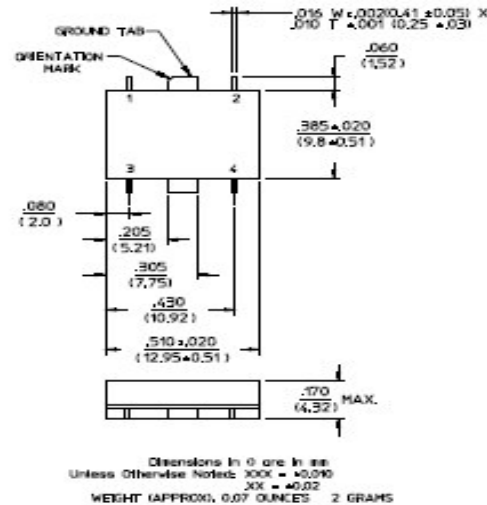

Dimensions in  $\square$  are in mm  
Unless Otherwise Noted: .00X = ±0.010  
.00X = ±0.02 (XX = ±0.50)  
WEIGHT (APPROX) 0.07 OUNCES 2 GRAMS

**Pin Configuration (For AMS-162)**

Pin No.	Function	Pin No.	Function
1	RF OUT	3	RF IN
2	VDC	4	GND

**Absolute Maximum Ratings <sup>1</sup>**

Parameter	Absolute Maximum
Max. Input Power	+10 dBm
Vbias	+15.75 V
Operating Temperature	-55°C to +85°C
Storage Temperature	-65°C to +125°C

1. Operation of this device above any one of these parameters may cause permanent damage.

- **North America** Tel: 800.366.2266 / Fax: 978.366.2266
- **Europe** Tel: 44.1908.574.200 / Fax: 44.1908.574.300
- **Asia/Pacific** Tel: 81.44.844.8296 / Fax: 81.44.844.8298

Visit [www.macom.com](http://www.macom.com) for additional data sheets and product information.

**Electrical Specifications: <sup>2</sup> T<sub>A</sub> = -55°C to +85°C Case Temperature**

Parameter	Test Conditions	Frequency	Units	Min.	Typ.	Max.
Gain	@+25°C	50 MHz	dB	12.0	12.5	13.0
Frequency Response	—	10 - 100 MHz	dB	—	—	±0.6
Gain Variation with Temperature	—	10 - 100 MHz	dB	—	—	±0.6
1 dB Compression	Output Power	10 - 100 MHz	dBm	+13	—	—
Noise Figure	—	10 - 100 MHz	dB	—	—	1.6
Reverse Transmission	—	10 - 100 MHz	dB	—	-15	-14
VSWR	—	10 - 100 MHz	Ratio	—	—	2.0:1
Output IP <sub>2</sub>	Two-Tone inputs up to 0 dBm	10 - 100 MHz	dBm	+40	—	—
Output IP <sub>3</sub>	Two-Tone inputs up to 0 dBm	10 - 100 MHz	dBm	+26	—	—
Vbias	—	—	VDC	+14.5	+15.0	+15.5
Ibias	Vbias = +15.0 VDC	—	mA	—	11	15
Power Dissipation	@ +15 V Bias	—	mW	—	165	—

2. All specifications apply when operated at +15 VDC, with 50 ohms source and load impedance.

**S-Parameter Data**

Frequency (MHz)	S11 MAG/ANG	S21 MAG/ANG	S12 MAG/ANG	S22 MAG/ANG
10	0.07/165	4.06/66	0.18	0.09/169.1
20	0.09/-166.8	4.13/-6.5	0.17	0.09/-159.2
30	0.08/-151.5	4.18/-15.8	0.17	0.09/-129.5
40	0.10/-146.9	4.20/-24.0	0.17	0.11/-120.3
50	0.11/-147.9	4.23/-32.2	0.17 1	0.12/-117.7
60	0.11/-152.0	4.19/-39.8	0.17	0.13/-118.5
70	0.12/-159.7	4.20/-47.7	0.17	0.14/-120.3
85	0.12/-171.2	4.17/-59.5	0.16	0.14/-122.6
100	0.12/174.1	4.15/-72.1	0.16	0.15/-123.6

**Typical Performance Curves**

**Gain vs. Frequency**

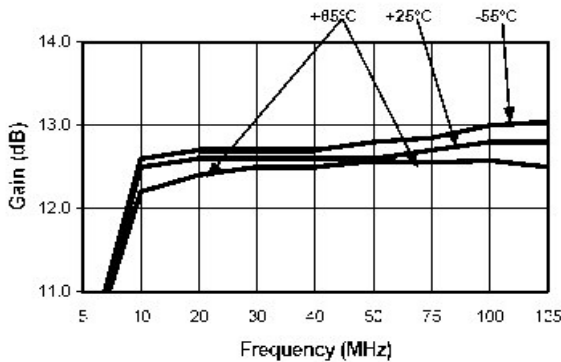

**VSWR vs. Frequency**

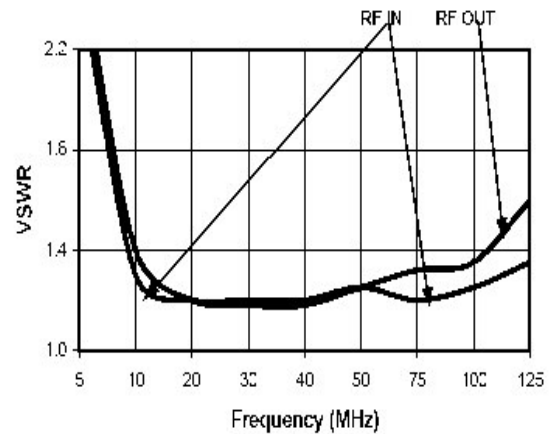

**Noise Figure**

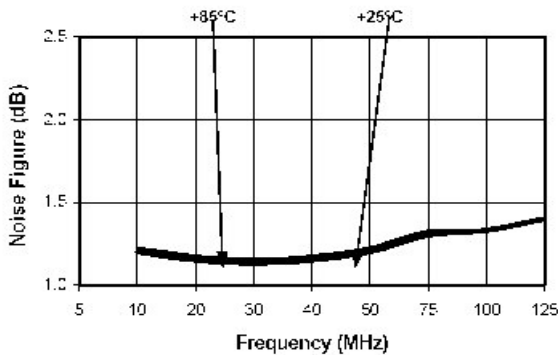

**1 dB Compression**

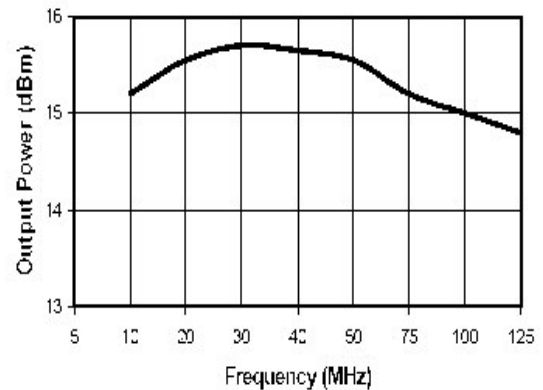

**Intermodulation Intercept**

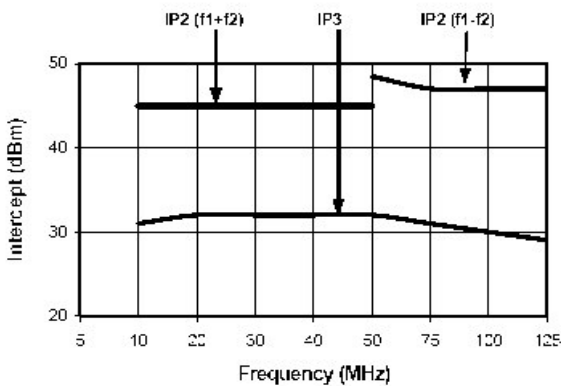

**Ordering Information**

Part Number	Package
AM-162 PIN	TO-8-1
AMC-162 SMA **	C-6
AMS-162 PIN	SF-1

\*\* The connectorized version is not RoHS compliant.