

High Dynamic Range Low Noise Amplifier 1400 - 2000 MHz

**AM50-0004
V6**

Features

- Low Noise Figure: 1.4 dB
- High Input IP3: +18 dBm at 8 V, 45 mA bias
+8 dBm at 3 V, 20 mA bias
- High Gain: 14 dB
- Single Supply: +3 to +8 VDC
- Low Cost SOIC-8 Plastic Package
- Adjustable current: 20 to 60 mA with external resistor

Description

M/A-COM's AM50-0004 is a high dynamic range, GaAs MMIC, low noise amplifier in a low cost, SOIC 8-lead, surface mount, plastic package. It employs external input matching to obtain optimum noise figure performance and operating frequency flexibility. The AM50-0004 also features flexible biasing to control the current consumption vs. dynamic range trade-off. The AM50-0004 can operate from any positive supply voltage in the 3 V to 8 V range. Its current can be controlled over a range of 20 mA to 60 mA with an external resistor.

The AM50-0004 is ideally suited for use where low noise figure, high gain, high dynamic range, and low power consumption are required. Typical applications included receiver front ends in PDC, DCS-1800, DCS-1900 and other PCN/PCS base stations. It is also useful as a gain block, buffer, driver, and IF amplifier in both fixed or portable PDC and PCN/PCS systems.

The AM50-0004 is fabricated using a low-cost 0.5-micron gate length GaAs process. The process features full passivation for increased performance and reliability. The AM50-0004 is 100% RF tested to ensure performance specification compliance.

Ordering Information

Part Number	Package
AM50-0004	Bulk Packaging
AM50-0004TR	1000 piece reel
AM50-0004SMB	Designer's Kit

Note: Reference Application Note M513 for reel size information.

Functional Block Diagram

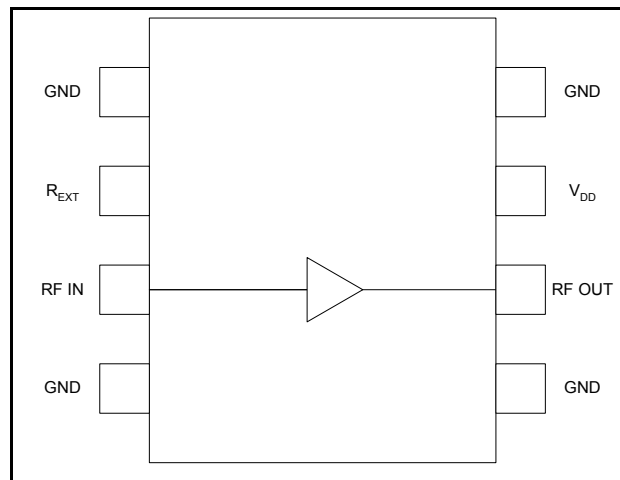

Pin Configuration

Pin No.	Pin Name	Description
1	GND	RF and DC Ground
2	R _{EXT}	External Current Control (optional)
3	RF IN	RF Input of the amplifier
4	GND	RF and DC Ground
5	GND	RF and DC Ground
6	RF OUT	RF Output of the amplifier
7	V _{DD}	Positive supply voltage
8	GND	RF and DC Ground

Absolute Maximum Ratings ^{1,2}

Parameter	Absolute Maximum
V _{DD}	+10 VDC
Input Power	+17 dBm
Current ³	80 mA
Channel Temperature ⁴	+150°C
Operating Temperature	-40°C to +85°C
Storage Temperature	-65°C to +150°C

1. Exceeding any one or combination of these limits may cause permanent damage.
2. M/A-COM does not recommend sustained operation near these survivability limits.
3. When pin #2 is used to increase current. (See note 7.)
4. Thermal resistance (θ_{jc}) = +99°C/W.

- **North America** Tel: 800.366.2266 / Fax: 978.366.2266
- **Europe** Tel: 44.1908.574.200 / Fax: 44.1908.574.300
- **Asia/Pacific** Tel: 81.44.844.8296 / Fax: 81.44.844.8298

Visit www.macom.com for additional data sheets and product information.

**High Dynamic Range Low Noise Amplifier
1400 - 2000 MHz**

**AM50-0004
V6**

Electrical Specifications: $T_A = +25^\circ\text{C}$, $Z_0 = 50\ \Omega$, $F = 1785\ \text{MHz}$, $P_{in} = -30\ \text{dBm}$

Parameter	Test Conditions	Units	Min.	Typ.	Max.
Gain	5 V, 45 mA ⁵	dB	12.0	14	—
	3 V, 20 mA	dB	—	12.5	—
Noise Figure	5 V, 45 mA ⁵	dB	—	1.4	1.8
	3 V, 20 mA	dB	—	1.5	—
Input VSWR	—	Ratio	—	1.5:1	—
Output VSWR	—	Ratio	—	2.0:1	—
Output 1 dB Compression	5 V, 45 mA ⁵	dBm	—	16.0	—
	3 V, 20 mA	dBm	—	9.0	—
Input IP3	5 V, 45 mA ⁵	dBm	13.0	15	—
	3 V, 20 mA	dBm	—	8.0	—
Reverse Isolation	—	dB	—	22	—
Drain Current	5 V, 45 mA ⁵	mA	30	45	60

5. Using external 15 Ω resistor. See functional schematic below.

Functional Schematic

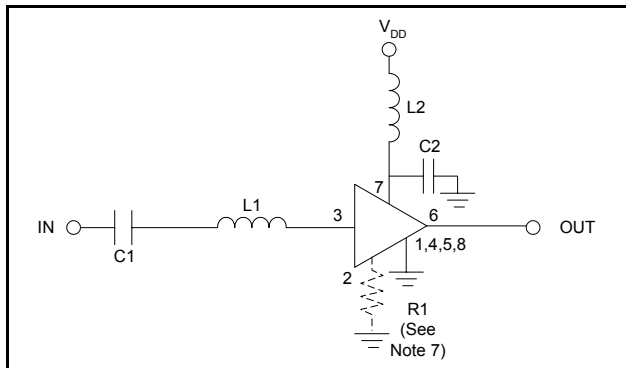

Handling Procedures

Please observe the following precautions to avoid damage:

Static Sensitivity

Gallium Arsenide Integrated Circuits are sensitive to electrostatic discharge (ESD) and can be damaged by static electricity. Proper ESD control techniques should be used when handling these devices.

External Components List ⁶

Part	Value	Case Size	Manufacturer	Purpose
C1	47 pF	0603	Murata	DC Block
C2	47 pF	0603	Murata	By-Pass
L1	3.9 nH	0603	Coilcraft	Tuning
L2	12 nH	0603	Coilcraft	RF Choke
R1	see note 7	0603	Panasonic	Optional current control

6. All external circuitry parts are readily available, low cost surface mount components (.060 in. x .030 in. or .080 in. x .050 in.).
7. Pin 2 allows use of an external resistor to ground for optional, higher current. For 20 mA operation, no resistor is used.
 For $I_{DD} \sim 30\ \text{mA}$, $R1 = 39\ \text{ohms}$;
 $I_{DD} \sim 45\ \text{mA}$, $R1 = 15\ \text{ohms}$;
 $I_{DD} \sim 60\ \text{mA}$, $R1 = 6\ \text{ohms}$.

**High Dynamic Range Low Noise Amplifier
1400 - 2000 MHz**

**AM50-0004
V6**

Recommended PCB Configuration

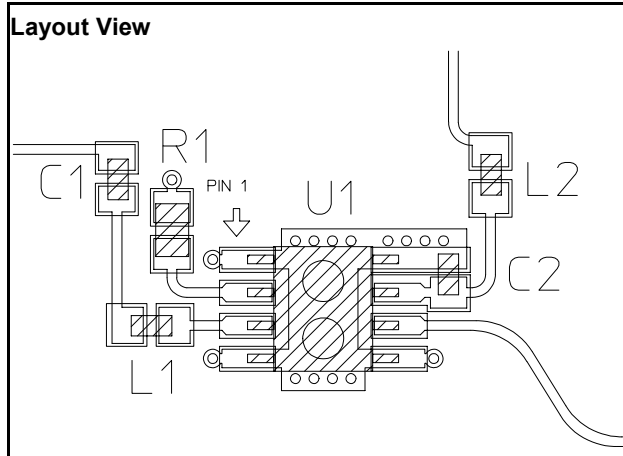

Cross Section View

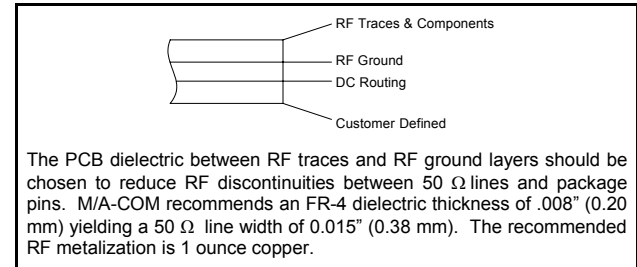

Designer's Kit AM50-0004SMB

The AM50-0004SMB Designer's Kit allows for immediate evaluation of M/A-COM's AM50-0004. The Designer's Kit includes an AM50-0004 mounted on an evaluation board and five loose AM50-0004's. The evaluation board consists of the recommended external surface mount circuitry, RF connectors, and a DC multi-pin connector, all mounted to a multi-layer FR-4 PCB. The AM50-0004SMB evaluation PCB is illustrated below with all functional ports labeled.

AM50-0004 Evaluation Board

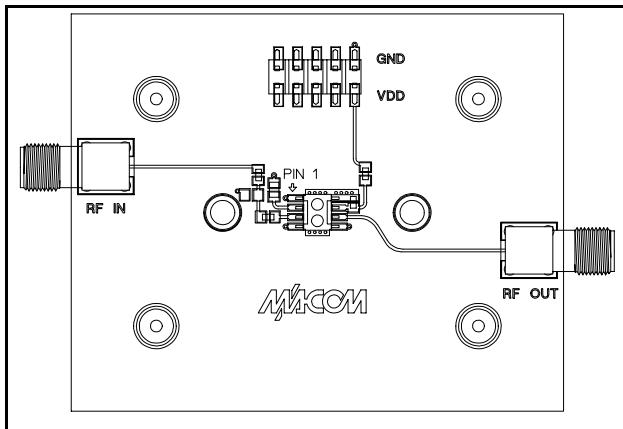

Evaluation PCB & RF Connector Losses

Port Reference	Approximate RF Loss
RF In	0.15 dB @ 1785 MHz
RF Out	0.15 dB @ 1785 MHz

The DC connector on the Designer's Kit PCB allows convenient DC line access. This is accomplished by the one or more of the following methods.

1. A mating female multi-pin connector (Newark Electronics Stock # 46F-4658, not included).
2. Wires soldered to the necessary pins (not included).
3. Clip leads (not included).

**High Dynamic Range Low Noise Amplifier
1400 - 2000 MHz**

**AM50-0004
V6**

Typical Performance Curves

Test Conditions: $T_A = +25^\circ\text{C}$, $Z_0 = 50 \Omega$, $V_{DD} = 5 \text{ V}$, $I_{DD} = 45 \text{ mA}$ unless otherwise specified.

Gain vs. Frequency

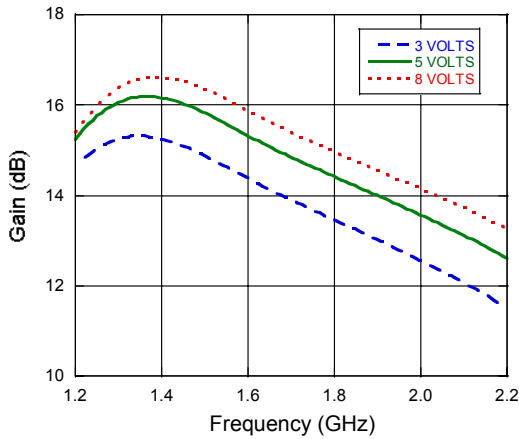

VSWR vs. Frequency

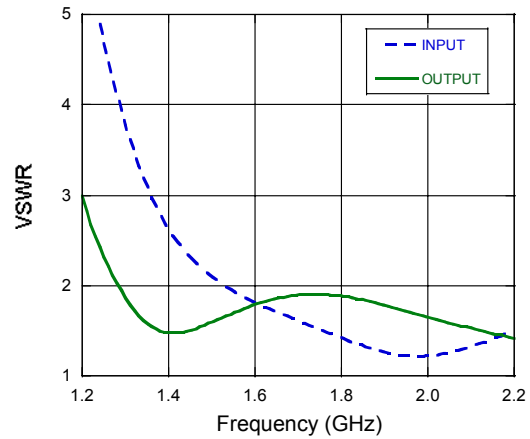

Noise Figure vs. Frequency

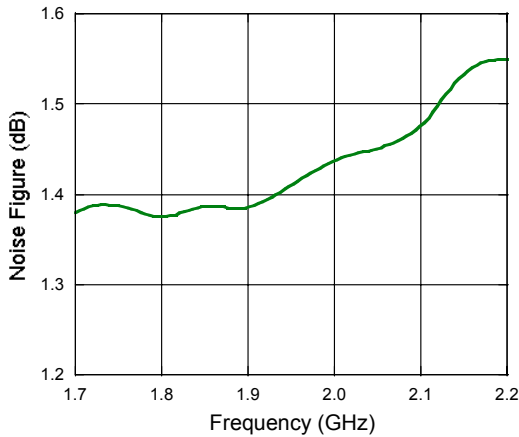

Noise Figure vs. Current, $F = 1785 \text{ MHz}$

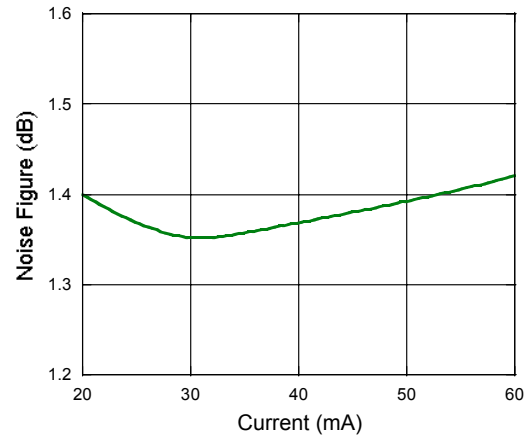

Output P1 dB vs. Frequency

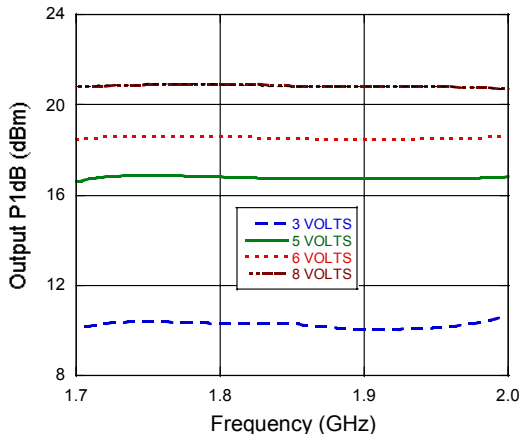

Output P1 dB vs. Current, $F = 1785 \text{ MHz}$

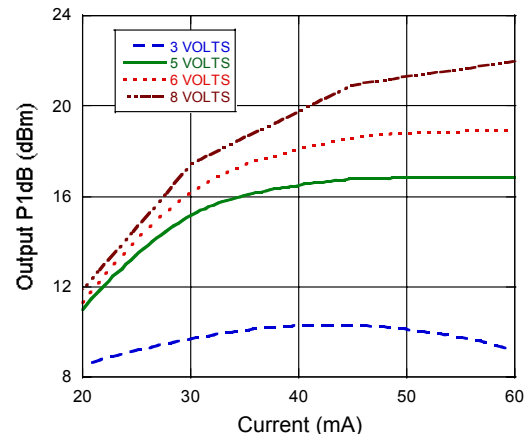

**High Dynamic Range Low Noise Amplifier
1400 - 2000 MHz**

**AM50-0004
V6**

Typical Performance Curves

Test Conditions: $T_A = +25^\circ\text{C}$, $Z_0 = 50 \Omega$, $V_{DD} = 5 \text{ V}$, $I_{DD} = 45 \text{ mA}$ unless otherwise specified.

Input IP3 vs. Frequency

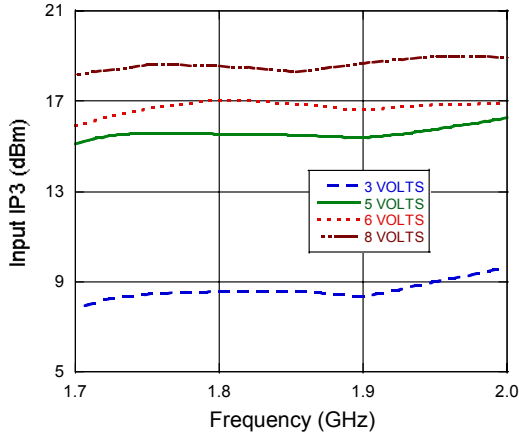

Input IP3 vs. Current, $F = 1785 \text{ MHz}$

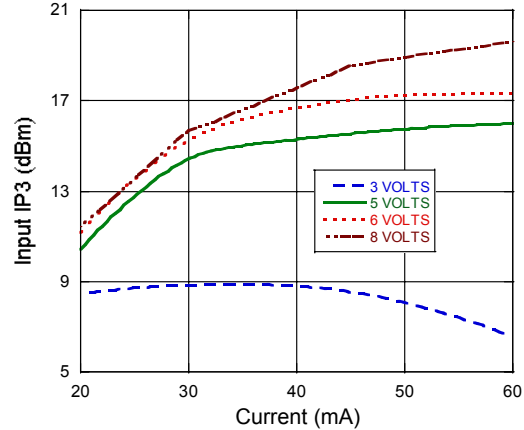

Gain vs. Temperature

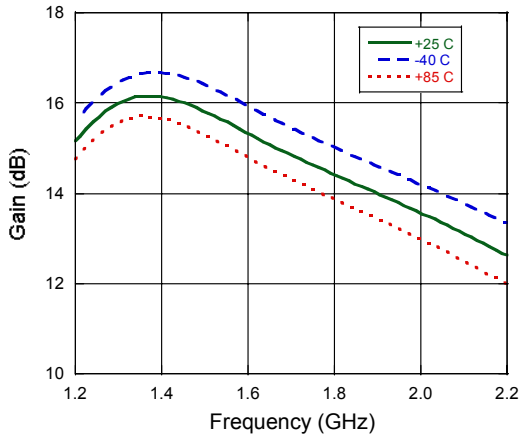

Noise Figure vs. Temperature

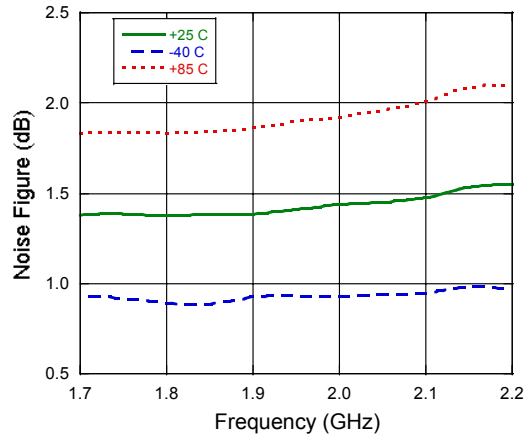

SOIC-8

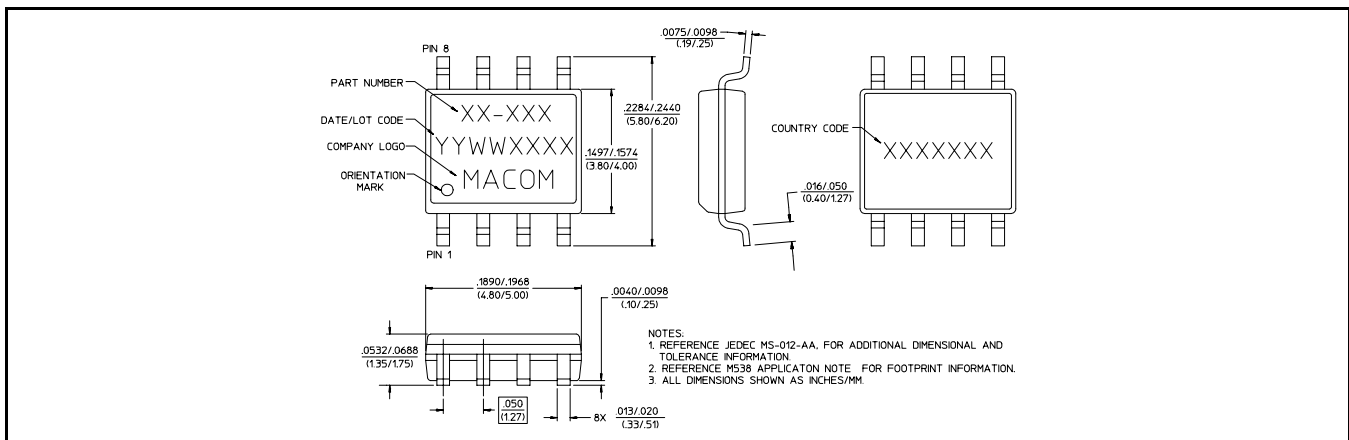

M/A-COM Inc. and its affiliates reserve the right to make changes to the product(s) or information contained herein without notice. M/A-COM makes no warranty, representation or guarantee regarding the suitability of its products for any particular purpose, nor does M/A-COM assume any liability whatsoever arising out of the use or application of any product(s) or information.

- **North America** Tel: 800.366.2266 / Fax: 978.366.2266
- **Europe** Tel: 44.1908.574.200 / Fax: 44.1908.574.300
- **Asia/Pacific** Tel: 81.44.844.8296 / Fax: 81.44.844.8298

Visit www.macom.com for additional data sheets and product information.