



Surface Mount Circulator



Features

- 24 dB Isolation Typical, 0.25 dB Insertion Loss Typical
- Compatible with Pick-and-Place Manufacturing and Solder Reflow Profiles
- Custom Products Available with Alternate Configurations such as Couplers, Attenuators, Higher Power Terminations, Reverse Circulation and Termination on Ports 1 or 2
- Available as Custom Product Without Flange for Surface Mount Applications (Solder Reflow)
- Designed for Wireless Telecommunications Systems: AMPS, N-AMPS, D-AMPS, EGSM, GSM, DCS1800, PCS1900

Description

M/A-COM's surface mount circulators and isolators, designed for cellular applications, feature high performance at low cost. These designs offer the best isolation per insertion loss ratio in the industry and are currently produced in the tens of thousands of pieces per year. These units can be ordered so as to be compatible with solder reflow manufacturing techniques. Both circulators and isolators are in stock at all authorized M/A-COM distributors.

FR31

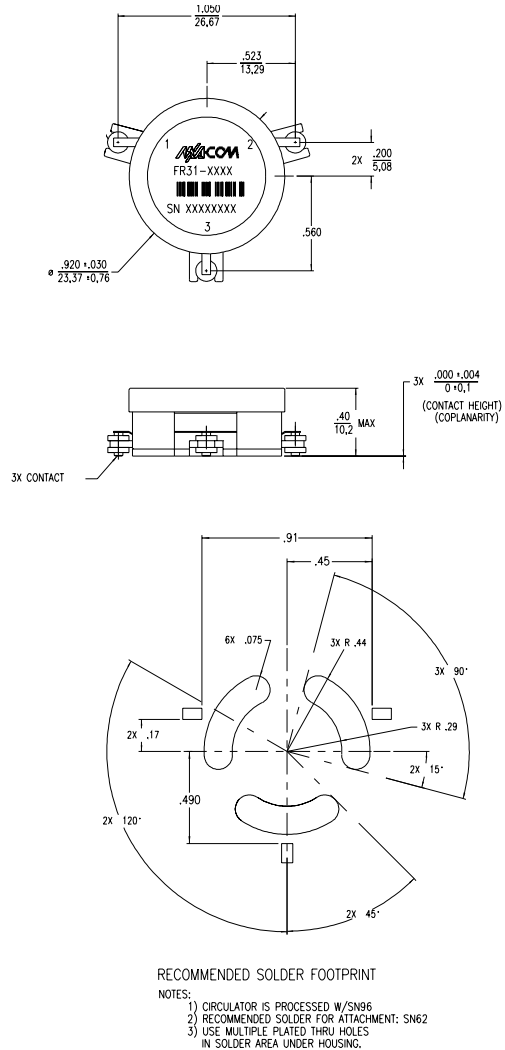

Part Number	Frequency Range (MHz)
FR31-0001	869 – 894
FR31-0002	925 – 960
FR31-0003	1805 – 1880
FR31-0004	1930 – 1990
FR31-0005	824 – 849
FR31-0006	880 – 915
FR31-0007	1710 – 1785
FR31-0008	1850 – 1910

Electrical Specifications

Parameter	Units	-10 to +60° C			-30 to +85° C		
		Min.	Typ.	Max.	Min.	Typ.	Max.
Isolation	dB	22	24	—	20	22	—
Insertion Loss	dB	—	0.25	0.3	—	0.30	0.35
Forward Power	Watts	—	—	65	—	—	65
VSWR	—	—	—	1.20	—	—	1.22

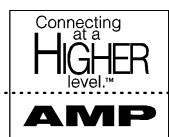

Typical Performance, T = +25°C

FR31-0001

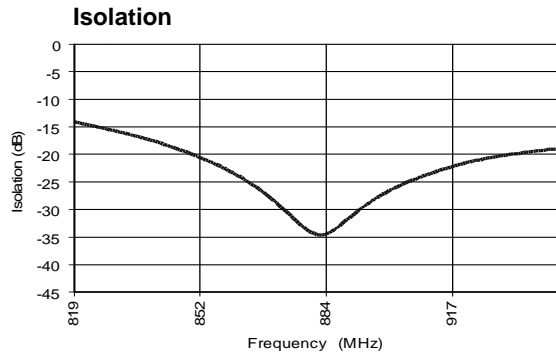

FR31-0002

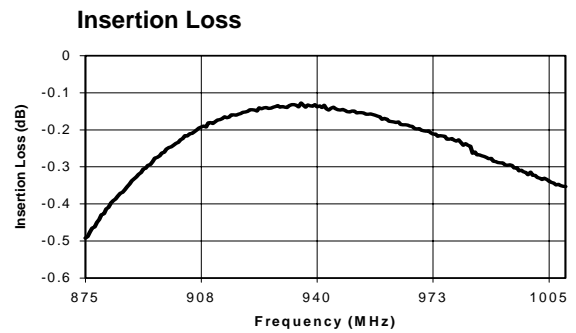
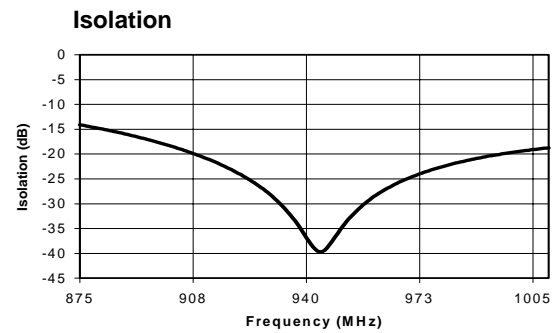

FR31-0003

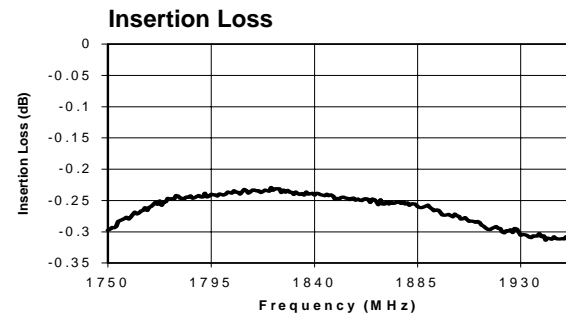
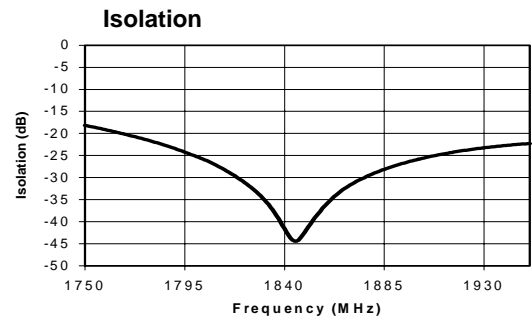

FR31-0004

