



# Surface Mount Isolator



## Features

- 24 dB Isolation Typical, 0.25 dB Insertion Loss Typical
- Compatible with Pick-and-Place Manufacturing and Solder Reflow Profiles
- Custom Products Available with Alternate Configurations such as Couplers, Attenuators, Higher Power Terminations, Reverse Circulation and Termination on Ports 1 or 2
- Available as Custom Product Without Flange for Surface Mount Applications (Solder Reflow)
- Designed for Wireless Telecommunications Systems: AMPS, N-AMPS, D-AMPS, EGSM, GSM, DCS1800, PCS1900

## FR32

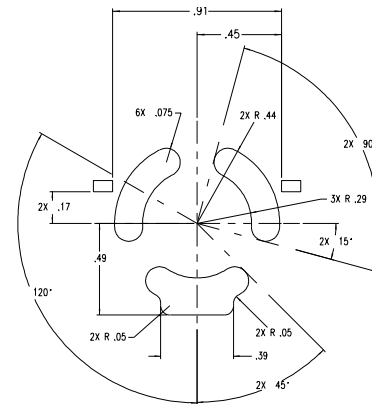
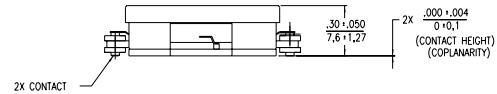
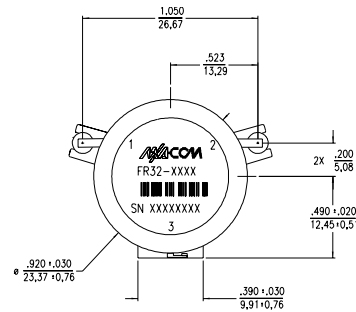

RECOMMENDED SOLDER FOOTPRINT  
 NOTES:  
 1) ISOLATOR IS PROCESSED W/SN96  
 2) RECOMMENDED SOLDER FOR ATTACHMENT: SN62  
 3) USE MULTIPLE PLATED THRU HOLES IN SOLDER AREA UNDER HOUSING.

## Description

M/A-COM's surface mount circulators and isolators, designed for cellular applications, feature high performance at low cost. These designs offer the best isolation per insertion loss ratio in the industry and are currently produced in the tens of thousands of pieces per year. These units can be ordered so as to be compatible with solder reflow manufacturing techniques. Both circulators and isolators are in stock at all authorized M/A-COM distributors.

Part Number	Frequency Range (MHz)
FR32-0001	869 – 894
FR32-0002	925 – 960
FR32-0003	1805 – 1880
FR32-0004	1930 – 1990
FR32-0005	824 – 849
FR32-0006	880 – 915
FR32-0007	1710 – 1785
FR32-0008	1850 – 1910

## Electrical Specifications

Parameter	Units	-10 to +60° C			-30 to +85° C		
		Min.	Typ.	Max.	Min.	Typ.	Max.
Isolation	dB	22	24	—	20	22	—
Insertion Loss	dB	—	0.25	0.3	—	0.30	0.35
Forward Power	Watts	—	—	65	—	—	65
Reflected Power	Watts	—	—	10	—	—	10
VSWR	—	—	—	1.20	—	—	1.22

V2.00

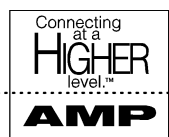

Typical Performance, T = +25°C

FR32-0001

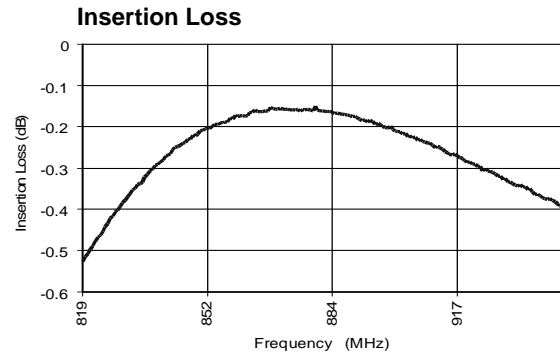
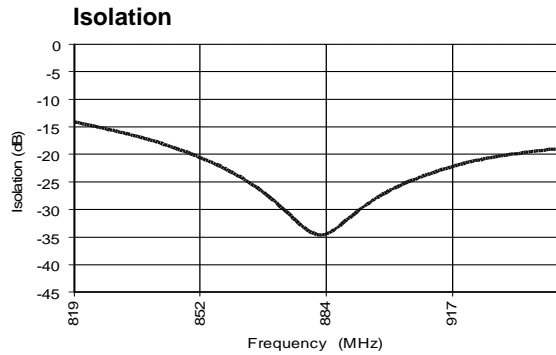

FR32-0002

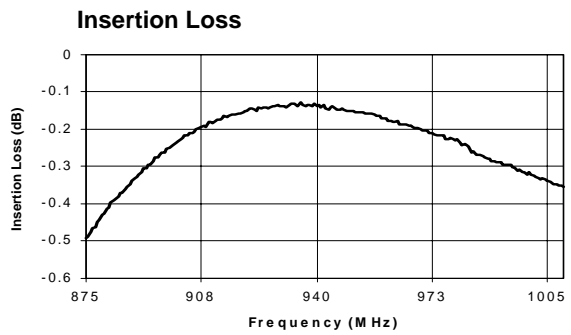
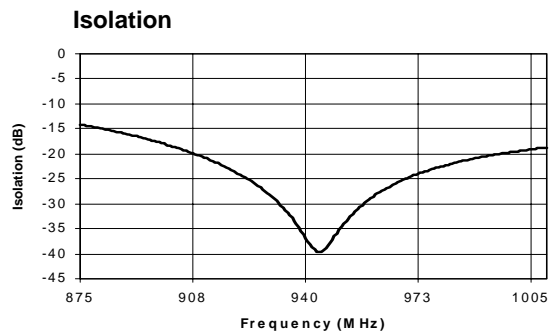

FR32-0003

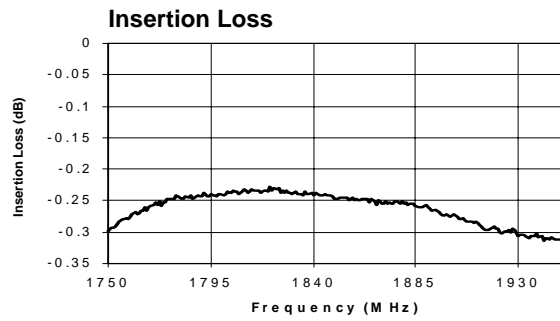
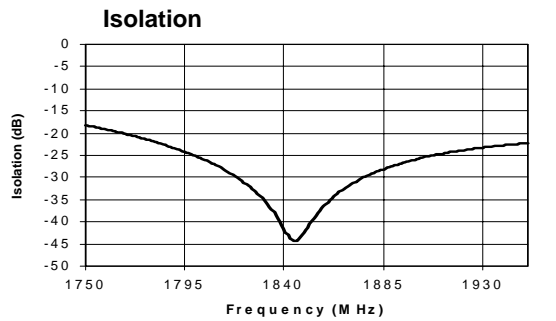

FR32-0004

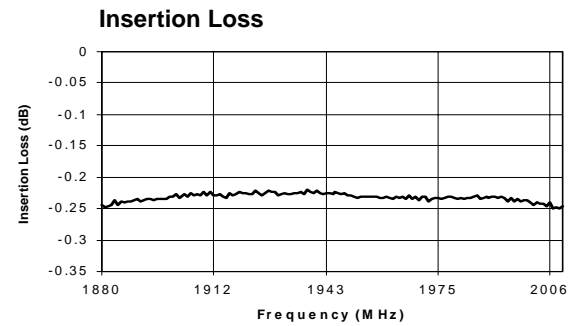
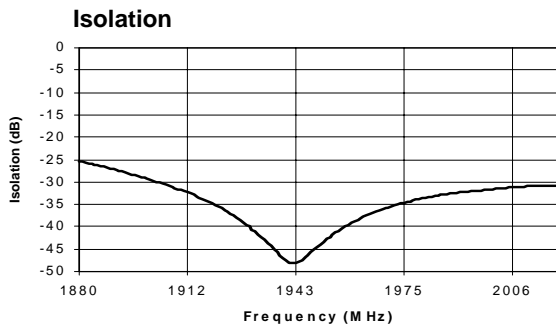

V2.00

M/A-COM Division of AMP Incorporated n North America: Tel. (800) 366-2266, Fax (800) 618-8883 n Asia/Pacific: Tel.+85 2 2111 8088, Fax +85 2 2111 8087  
 n Europe: Tel. +44 (1344) 869 595, Fax+44 (1344) 300 020

www.macom.com

AMP and Connecting at a Higher Level are trademarks.  
 Specifications subject to change without notice.

