



Tyco Electronics Mid-Range Military/Aerospace Relays

10 AMPERES, DPDT



- HERMETICALLY SEALED
- ALL WELDED CONSTRUCTION
- BALANCED FORCE
- PERMANENT MAGNET DRIVE
- CONTACTS: SILVER CADMIUM OXIDE WITH GOLD PLATING
- COILS FOR DC, 50 TO 400Hz AND 400Hz AC
- WEIGHT 1.6 OUNCES MAX. (45.4 GRAMS)

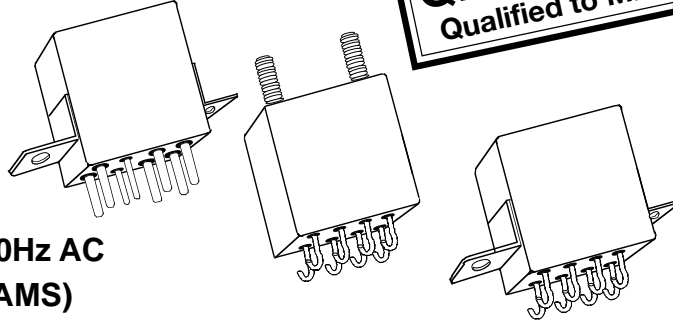

The Series FCA-210 relay is a polarized single-side stable design, where the flux from a permanent magnet provides the armature holding force in the deactivated state, and its flux path is switched and combined with the coil flux in the operated state. This results in appreciably increased contact pressure in both states over that of a spring return nonpolar design. We also manufacture other versions of this relay:

- FCA-410:** 10 AMPERE 4PDT RELAY
- FCA-610:** 10 AMPERE 6 PDT RELAY

AVAILABLE

FCA-215: 15 AMPERE DPDT RELAY, HAS THE SAME SPECIFICATIONS AS THE FCA-210 EXCEPT IS RATED AT 15 AMPS.

CONTACT RATING-AMPERES

Ratings Are Continuous Duty

TYPE OF LOAD	LIFE (MIN.) CYCLES X 10 ³	28 VDC	115VAC 400Hz	115/200VAC 3Ø	
				400 Hz	60Hz *
Resistive	100	10	10	10	2.5
Inductive	20	8	8	8	2.5
Motor	100	4	4	4	2.0
Lamp	100	2	2	2	1
* 60 Hz LOADS RATED FOR 10,000 OPERATIONS					

OVERLOAD CURRENT 40 AMPS DC, 60AMPS 400Hz
 RUPTURE CURRENT 50 AMPS DC, 80 AMPS 400Hz
 CONTACT MAKE BOUNCE 1 MILLISECOND AT NOMINAL VOLTAGE
 MAX. CONTACT DROP AT 10 AMPS: INITIAL 0.100 VOLTS.
 END OF LIFE 0.125 VOLTS



Tyco Electronics Mid-Range Military/Aerospace Relays

10 AMPERES, DPDT

COIL DATA

COIL CODE	NOMINAL VOLTAGES	FREQ. Hz	DC RES. AC AMPS (B)	OVER TEMPERATURE RANGE		
				PICKUP OR BELOW VOLTS	DROPOUT OR ABOVE VOLTS	MUST HOLD VOLTAGE (C)
1	6	DC	20 Ω	4.5	0.3	2.5
2	12	DC	80 Ω	9.0	0.75	4.5
3	28	DC	320 Ω	18.0	1.5	7.0
4 (A)	28	DC	320 Ω	18.0	1.5	7.0
5	48	DC	920 Ω	32.0	2.5	14.0
6	28	400Hz	180 mA	22.0	1.25	10.0
7	28	50/400Hz	100 mA	22.0	1.25	10.0
8	115	400 Hz	40 mA	90.0	5.0	40.0
9	115	50/400Hz	30 mA	95.0	5.0	40.0

- A. CODE 4 COILS HAVE BACK EMF SUPPRESSION TO 42 VOLTS MAX.
- B. DC COIL RESISTANCE $\pm 10\%$ AT 25°C; AC COIL MAX. CURRENT AT NOMINAL VOLTAGE.
- C. RELAY WILL STAY IN PICKED-UP STATE DOWN TO MUST HOLD VOLTAGES SHOWN.
- D. MAX. OVERVOLTAGE: 6 & 12 VDC COILS 120% OF NOMINAL; ALL OTHERS 110% OF NOMINAL.
- E. COILS AVAILABLE FOR OTHER VOLTAGES AND FOR AC 50/60HZ.
- NOTE: Only DC Coil Models are QPL Approved.

GENERAL SPECIFICATIONS

TEMPERATURE RATING:		-70°C TO + 125°C
ALTITUDE:		300,000 FEET
SHOCK:*	Z, Y, & X ENCLOSURES	200 g FOR 6 mS
	W & M ENCLOSURES (STUD MTG.)	100 g FOR 6 mS
VIBRATION, SINUSOIDAL:*	Z, Y, & X ENCLOSURES	30 g 33-3000Hz
	W & M ENCLOSURES (STUD MTG.)	20 g 33-3000Hz
VIBRATION, RANDOM: *	Z, Y, & X ENCLOSURES	0.4 g ² /Hz 50-2000Hz
	W & M ENCLOSURES (STUD MTG.)	0.2 g ² /Hz 50-2000Hz
DIELECTRIC STRENGTH AT SEA LEVEL:	ALL CIRCUITS TO GROUND AND CIRCUIT TO CIRCUIT.	1250 V rms
	COIL TO GROUND	1000 V rms
DIELECTRIC STRENGTH AT 80,000 FEET:		350 V rms
INSULATION RESISTANCE:	INITIAL (500 VDC)	100 MΩ MINIMUM
	AFTER LIFE OR ENVIRONMENTAL TESTS	50 MΩ MINIMUM
OPERATE TIME AT NOMINAL VOLTAGE:	DC RELAYS	10 ms OR LESS
	AC RELAYS	15 ms OR LESS
RELEASE TIME AT NOMINAL VOLTAGE:	DC RELAYS	10 ms OR LESS
	AC RELAYS	50 ms OR LESS

* Max. contact opening under vibration or shock 10 microseconds



Tyco Electronics Mid-Range Military/Aerospace Relays

10 AMPERES, DPDT

Below are shown the standard terminal types and the enclosures available. Specify the assembly as indicated under How To Order. Dimensions are shown in inches $\pm .010$ and (Millimeters $\pm .25$).

TERMINALS

SOCKET PINS ARE GOLD PLATED
POLARIZING PINS ARE TIN/LEAD PLATED
CIRCUIT BOARD PINS ARE TIN/LEAD PLATED
DIMENSIONS EXCEPT AS NOTED:
INCHES $\pm .010$ (MILLIMETERS $\pm .25$)

CODE

"A" Socket Pins - All DC Coils

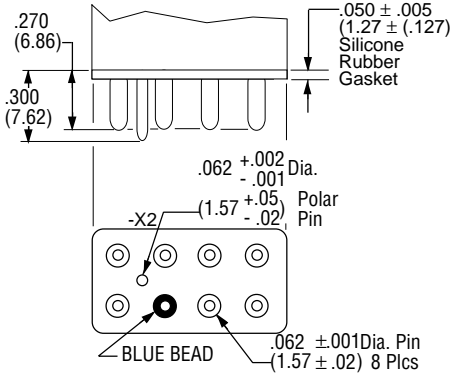

CODE

"B" Circuit Board Pins - All DC Coils

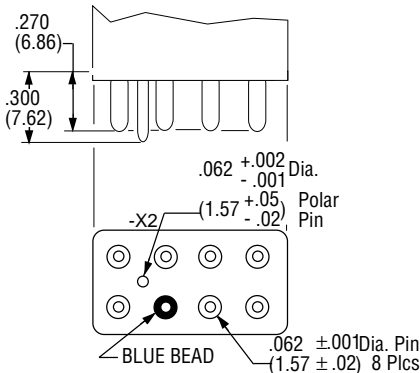

CODE

"C" Solder Hook Terminals

HOOK TERMINALS TIN/LEAD PLATED

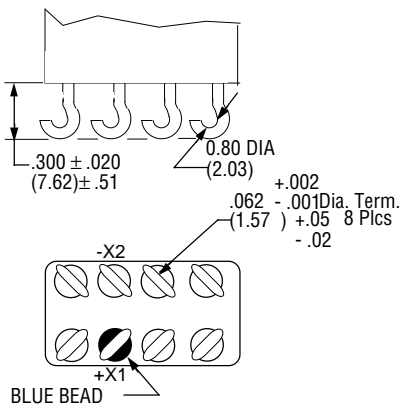

CODE

"D" Socket Pins 115 VAC

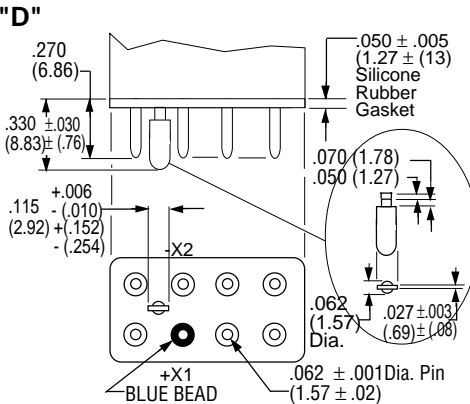

CODE

"E" Socket Pins 28 VAC Coils

Same as Code "D" Except polarizing Pin turned 90° to this plane.

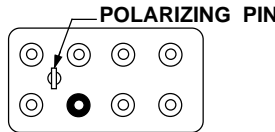

CODE

"F" Circuit Board Pins 115 VAC Coils

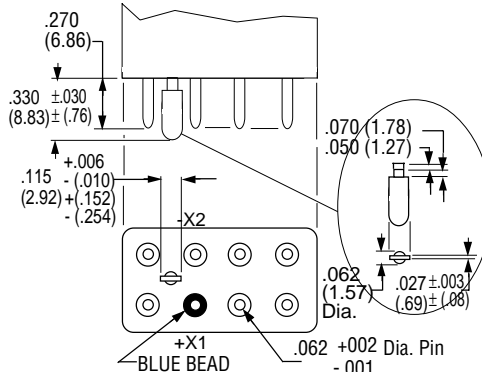

CODE

"F" Circuit Board Pins 28 VAC Coils

Same as Code "D" Except polarizing Pin turned 90° to this plane.

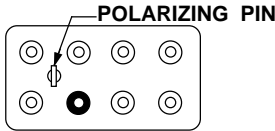

CODE

"H" 90° Solder Pins

All Pins Bright Acid Tin/lead

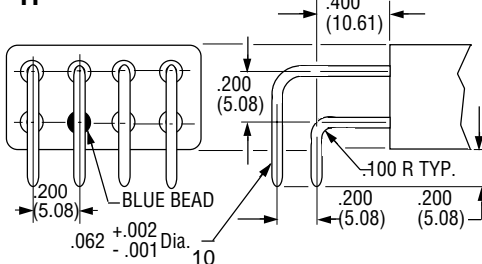

ENCLOSURES

All Enclosures have Cupro-Nickel Cans bright acid tin/lead plated after assembly to terminal headers.

Dimensions: Inches $\pm .010$ (mm $\pm .25$)

"A" AC Coils 1.125 in. (28.57) Max.
DC Coils 1.010 in. (25.65) Max.

CODE

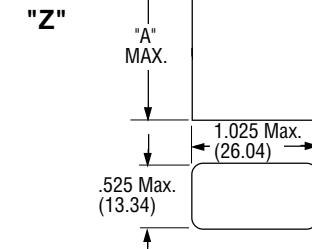

CODE

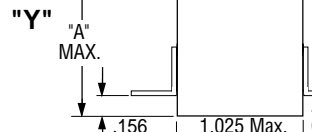

CODE

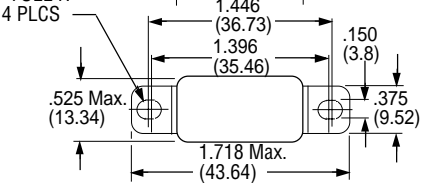

CODE

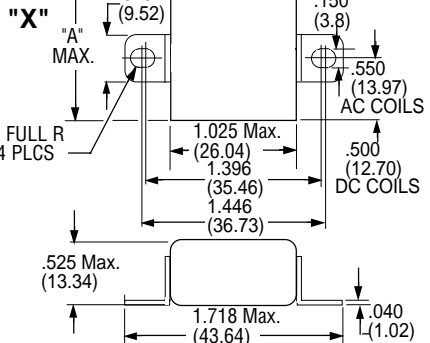

CODE

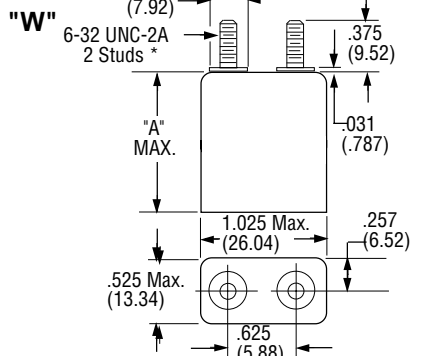

*Metric threads available. To specify use \square in place of \square



Tyco Electronics Mid-Range Military/Aerospace Relays

10 AMPERES, DPDT

TERMINAL WIRING

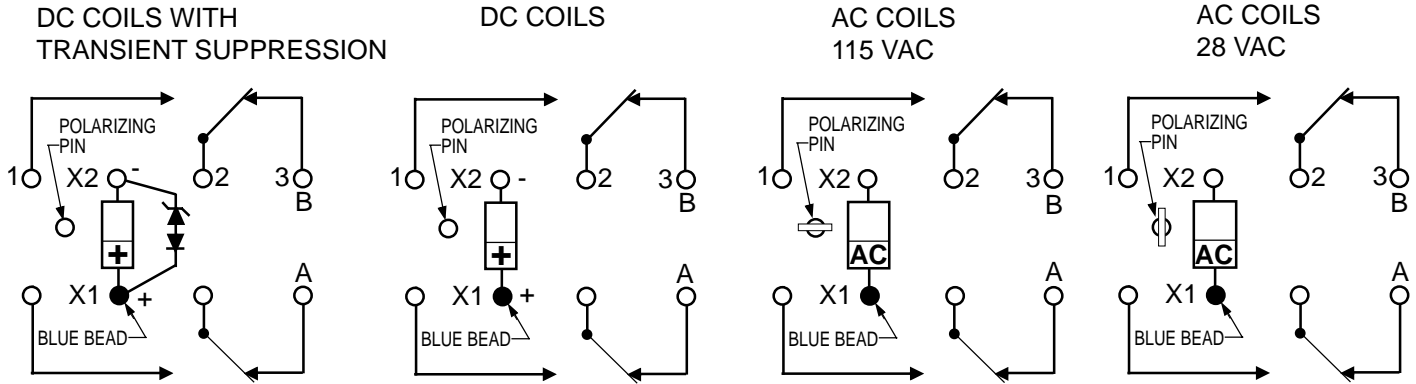

NOTE: Polarity must be observed with DC coil supply. Relay is polarized with a permanent magnet and will not operate or be damaged by reverse polarity.

Diodes used in transient suppression and in AC rectifier circuits have peak inverse voltage rating of 600 VDC minimum. Zener diodes have a minimum rating of 1 watt.

Terminal designations are for reference only and do not appear on the header.

TERMINAL LAYOUT

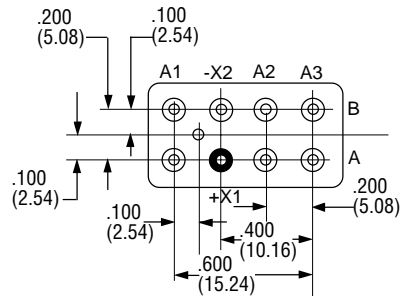

HOW TO ORDER

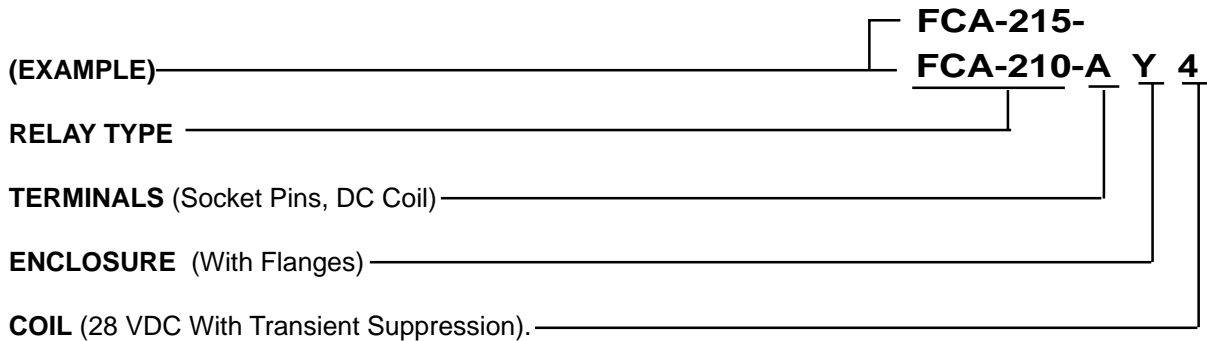

NOTE: Only DC coil models are QPL Approved