

FEATURES

- Low Quiescent Current: 6.5µA Typ**
- Supply Range: 1.7V to 5.5V**
- 400mV Reference ±0.8% Accuracy Over Temperature**
- Input Range Includes Ground**
- User programmable Hysteresis via resistor string**
- Low Input Bias Current: ±10nA Max**
- Open drain outputs with 40mA Typical Sink Current**
- Supports Wired-AND Connections**
- Input Polarities:**
 - ADCMP341 noninverting
 - ADCMP343 inverting
- Small SOT-23 Package**

APPLICATIONS

- Battery-Powered System Monitoring**
- Threshold Detectors**
- Relay Driving**
- Optoisolator Driving**
- Handheld Instruments**

GENERAL DESCRIPTION

The ADCMP341/ADCMP343 combine two low power, low voltage comparators with a 400mV reference in the 5-lead SOT-23 package. Operating within a supply range of 1.7V to 5.5V, the devices only draw 6.5µA typical, making them ideal for low voltage system monitoring and portable applications.

Hysteresis is determined using three resistors in a string configuration with the upper and lower tap points connected to the INA_U and INA_L pins of each comparator respectively. The state of the comparators output internally selects which pin is connected to the comparator inputs. So a change of state in the comparator output will result in one of the inputs being switched in to the comparator and the other being switched out. This will provide the user with a fully flexible and simple method of setting the hysteresis. Although there are two pins available on each comparator, there is only actually one input available externally at any one time, the other inputs are connected internally to the reference.

The comparator outputs are open drain with the output stage sinking capability guaranteed greater than 5mA over temperature. The ADCMP341 have noninverting inputs and the ADCMP343 have inverting inputs. Available in commercial, industrial and automotive temperature ranges.

FUNCTIONAL BLOCK DIAGRAM

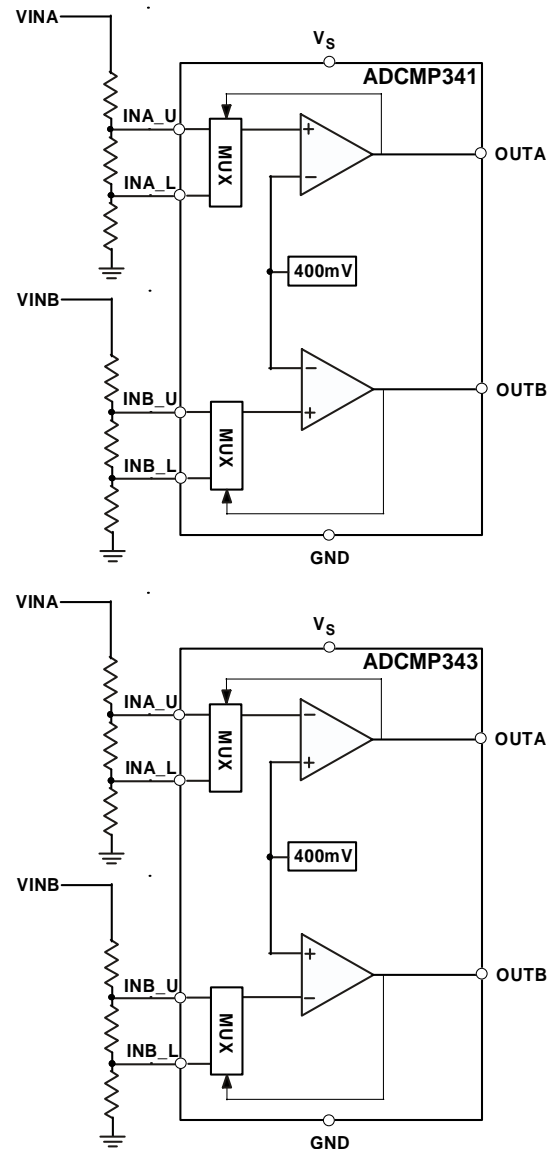

Figure 1

Rev. PrD

Information furnished by Analog Devices is believed to be accurate and reliable. However, no responsibility is assumed by Analog Devices for its use, nor for any infringements of patents or other rights of third parties that may result from its use. Specifications subject to change without notice. No license is granted by implication or otherwise under any patent or patent rights of Analog Devices. Trademarks and registered trademarks are the property of their respective owners.

TABLE OF CONTENTS

Specifications.....	3	Applications INFORMATION	11
Absolute Maximum Ratings.....	4	Comparators and Internal reference.....	11
ESD Caution.....	4	programming Hysteresis	11
Pin Configuration and Function Descriptions.....	5	Outline Dimensions	12
Typical Performance Characteristics	6	Ordering Guide	12

REVISION HISTORY

SPECIFICATIONS**Table 1.**

$V_{CC} = 1.7V$ to $5.5V$, $-40^{\circ}C \leq T_A \leq 125^{\circ}C$, unless otherwise noted.

Parameter	Min	Typ	Max	Unit	Test Conditions/Comments
Reference Voltage	396.8	400	403.2	mV	$V_s = 1.7V$, Note1
	396.8	400	403.2	mV	$V_s = 5V$, Note1
Reference Voltage Accuracy		± 0.8	± 1.0	%	$V_s = 1.7V$, Note1
		± 0.8	± 1.0	%	$V_s = 5V$, Note1
Input Bias Current		0.01	10	nA	$V_s = 1.7V$, $V_{in} = V_s$
		4	10	nA	$V_s = 1.7V$, $V_{in} = 0.1V$
Output Low Voltage		60	200	mV	$V_s = 1.7V$, $I_{out} = 3mA$, Note2
		70	200	mV	$V_s = 5V$, $I_{out} = 5mA$, Note2
Output Leakage Current		0.01	1	μA	$V_s = 1.7V$, $V_{out} = V_s$, Note3
		0.01	1	μA	$V_s = 1.7V$, $V_{out} = 5.5V$, Note3
High-to-Low Propagation Delay		29		μs	$V_s = 5V$, $V_{ol} = 400mV$, Note2,4
Low-to-High Propagation Delay		18		μs	$V_s = 5V$, $V_{oh} = 0.9 \times V_s$, Note2,4
Output Rise time		2.2		μs	$V_s = 5V$, $V_o = (0.1 \text{ to } 0.9) \times V_s$, Note2,4
Output Fall time		0.22		μs	$V_s = 5V$, $V_o = (0.1 \text{ to } 0.9) \times V_s$, Note2,4
Supply Current		6.5	10	μA	$V_s = 1.7V$
		6.5	10	μA	$V_s = 5.5V$

Note1: $R_L = 100K$, $V_o = 2V$ Swing

Note2: 10mV input overdrive

Note3: $V_{in} = 40mV$ overdrive

Note4: $R_L = 10K$

Note5: No load

ABSOLUTE MAXIMUM RATINGS

$T_A = 25^\circ\text{C}$, unless otherwise noted.

Table 2. .

Parameter	Rating
V_s	-0.3V to +6V
INx	-0.3V to +6V
OUTx	-0.3V to +6V
Operating Temperature Range	-40°C to +125°C
Storage Temperature Range	-65°C to +150°C
θ_{JA} Thermal Impedance, SC70	146°C/W
Lead Temperature	
Soldering (10 sec)	300°C
Vapor Phase (60 sec)	215°C
Infrared (15 sec)	220°C

Stresses above those listed under Absolute Maximum Ratings may cause permanent damage to the device. This is a stress rating only and functional operation of the device at these or any other conditions above those indicated in the operational section of this specification is not implied. Exposure to absolute maximum rating conditions for extended periods may affect device reliability.

ESD CAUTION

ESD (electrostatic discharge) sensitive device. Electrostatic charges as high as 4000 V readily accumulate on the human body and test equipment and can discharge without detection. Although this product features proprietary ESD protection circuitry, permanent damage may occur on devices subjected to high energy electrostatic discharges. Therefore, proper ESD precautions are recommended to avoid performance degradation or loss of functionality.



PIN CONFIGURATION AND FUNCTION DESCRIPTIONS

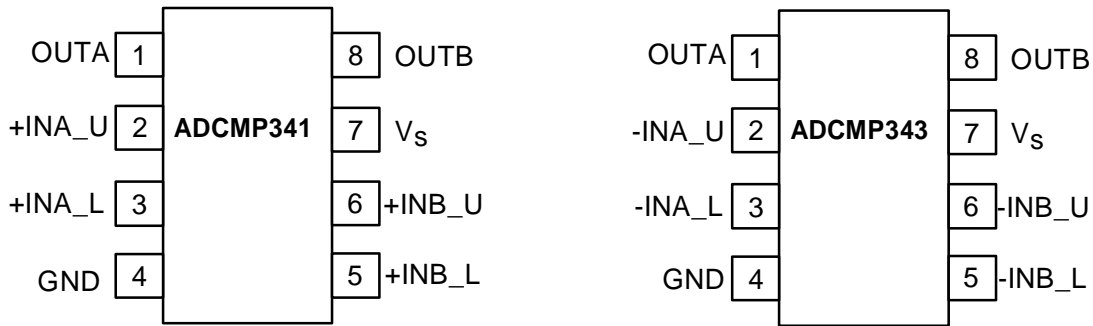

Figure 2. Pin Configuration

Table 3. Pin Function Descriptions

Pin No.	Mnemonic	Description
1	OUTA	Open Drain Output for comparator A. Capable of sinking up to 40mA of current.
2	INA_U	Monitors Analog Input Voltage on comparator A. Connect to the upper tap point of the resistor string. Connected internally to the noninverting input on the ADCMP341 or the inverting pin on the ADCMP343 via mux controlled by output level on comparator A. The other input of comparator A is connected to a 400mV reference.
3	INA_L	Monitors Analog Input Voltage on comparator A. Connect to the lower tap point of the resistor string. Connected internally to the noninverting input on the ADCMP341 or the inverting pin on the ADCMP343 via mux controlled by output level on comparator A. The other input of comparator A is connected to a 400mV reference.
4	GND	Ground
5	INB_L	Monitors Analog Input Voltage on comparator B. Connect to the lower tap point of the resistor string. Connected internally to the noninverting input on the ADCMP341 or the inverting pin on the ADCMP343 via mux controlled by output level on comparator B. The other input of comparator B is connected to a 400mV reference.
6	INB_U	Monitors Analog Input Voltage on comparator B. Connect to the upper tap point of the resistor string. Connected internally to the noninverting input on the ADCMP341 or the inverting pin on the ADCMP343 via mux controlled by output level on comparator B. The other input of comparator B is connected to a 400mV reference.
7	Vs	Power Supply. Operates from 1.7V to 5.5V.
8	OUTB	Open Drain Output for comparator B. Capable of sinking up to 40mA of current.

TYPICAL PERFORMANCE CHARACTERISTICS

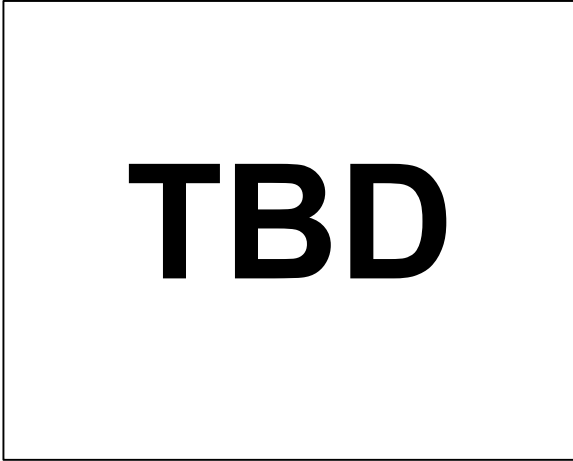

Figure 3. Distribution of Rising Input Threshold Voltage

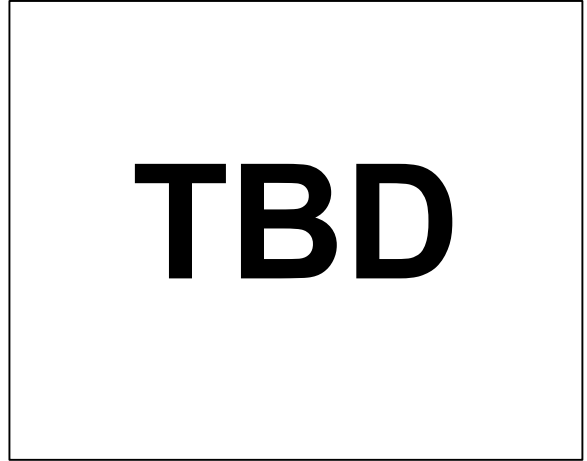

Figure 6. Distribution of Falling Input Threshold Voltage

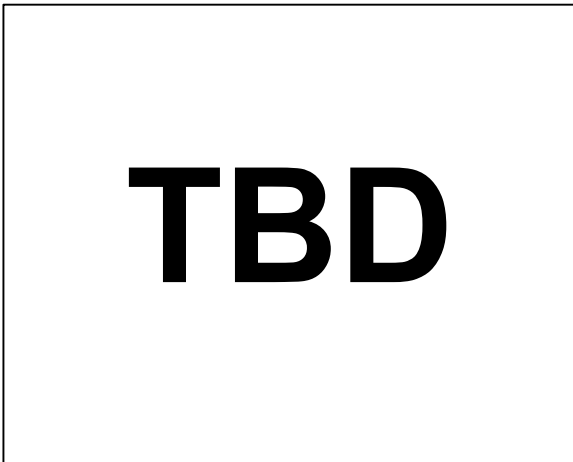

Figure 4. ???

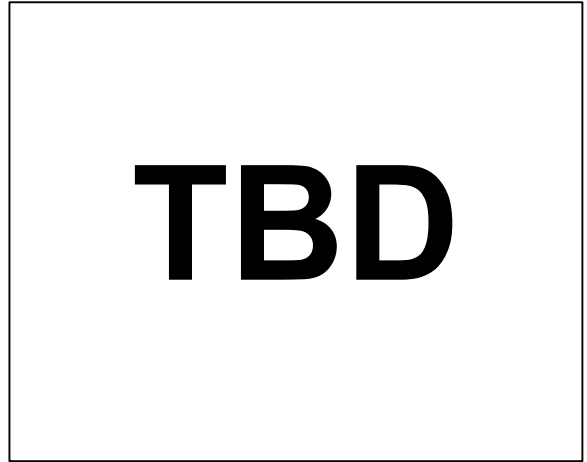

Figure 7. Rising Input Threshold Voltage vs Temperature

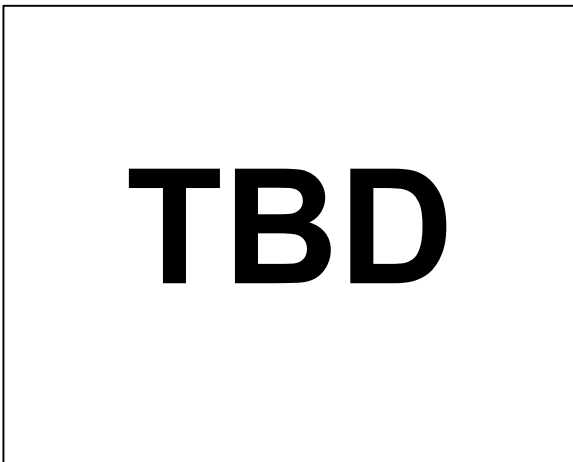

Figure 5. Rising Input Threshold Voltage vs Temperature

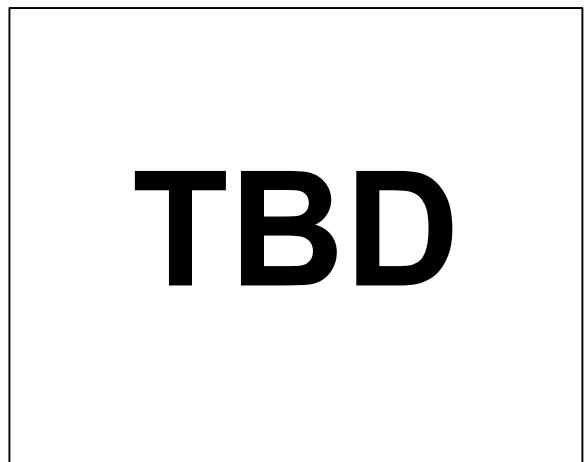

Figure 8. Rising Input Threshold Voltage vs Supply Voltage

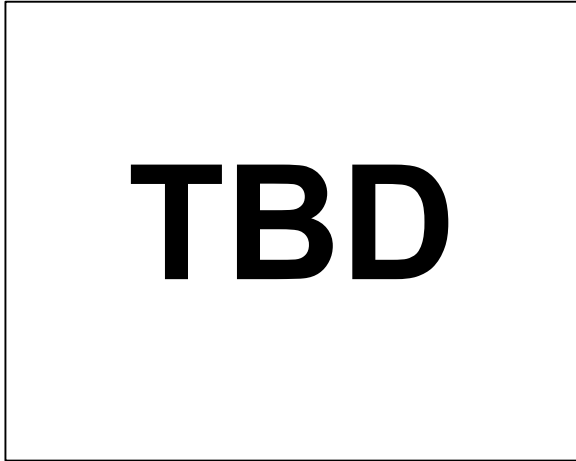

Figure 9. ???e

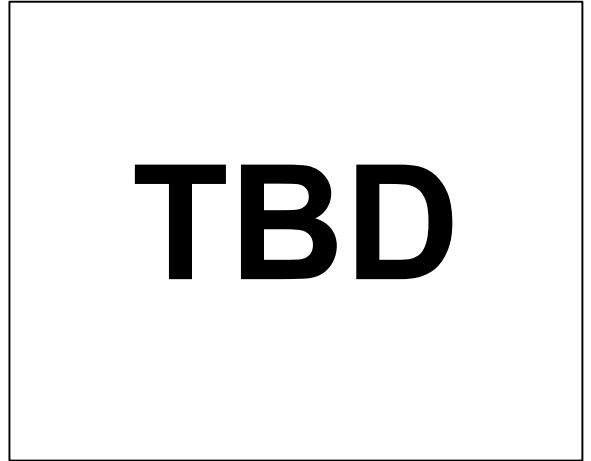

Figure 12. ???

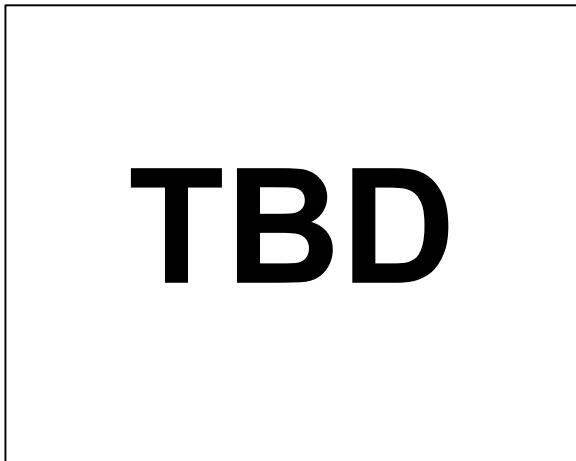

Figure 10. ???

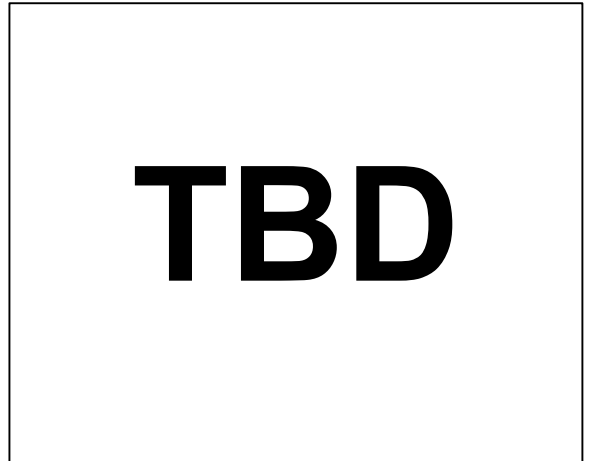

Figure 13. Minimum Supply Voltage

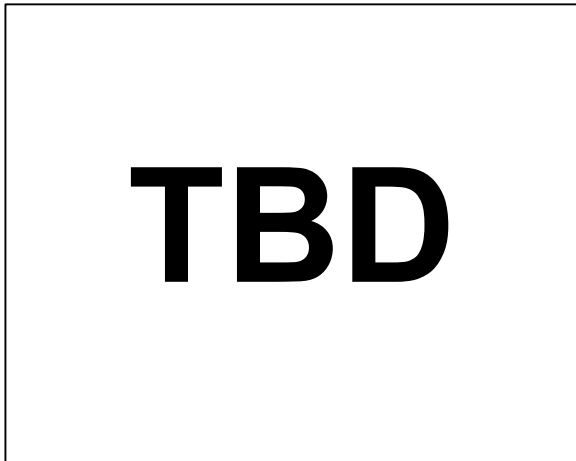

Figure 11. Quiescent Supply Current vs Supply Voltage

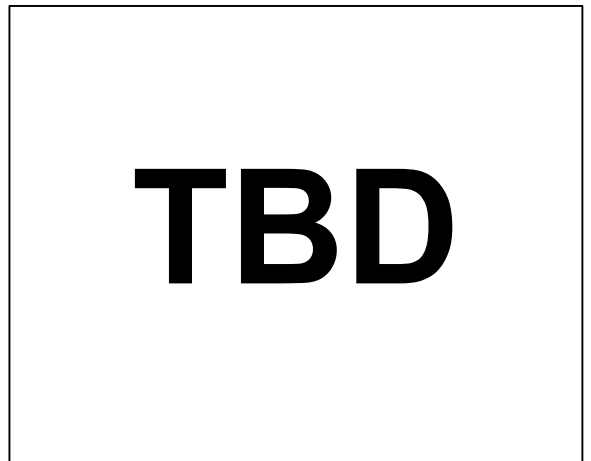

Figure 14. Startup Supply Current

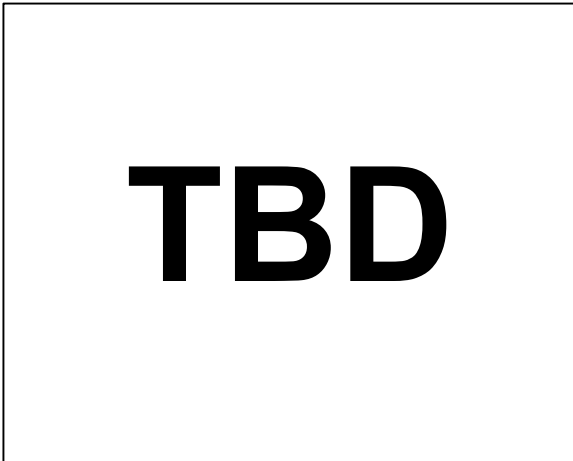

Figure 15. Supply Current vs Output Sink Current

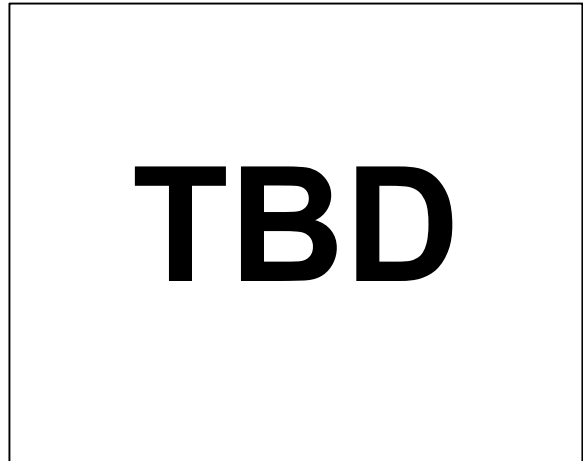

Figure 18. Below Ground Input Bias Current

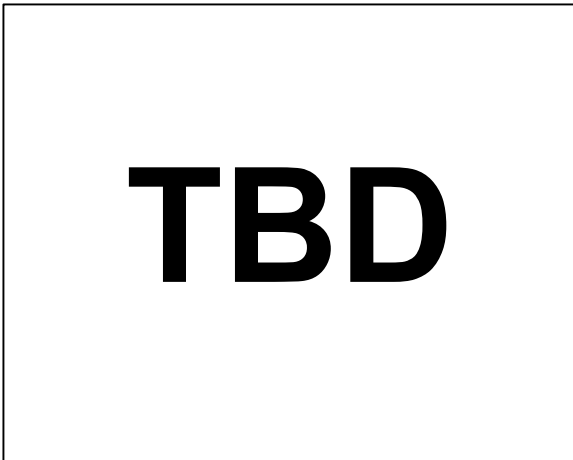

Figure 16 Supply Current vs Output Sink Current

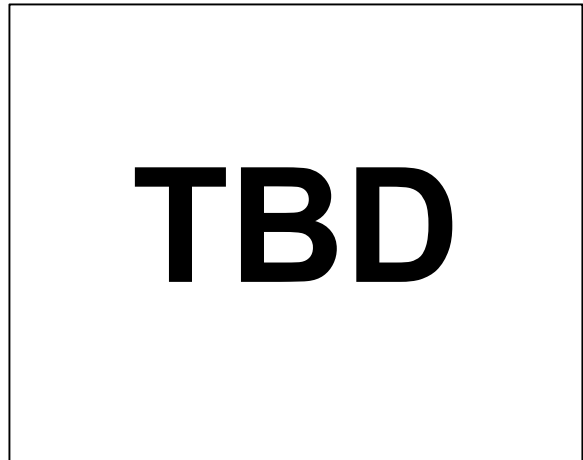

Figure 19. Low Level Input Bias Current

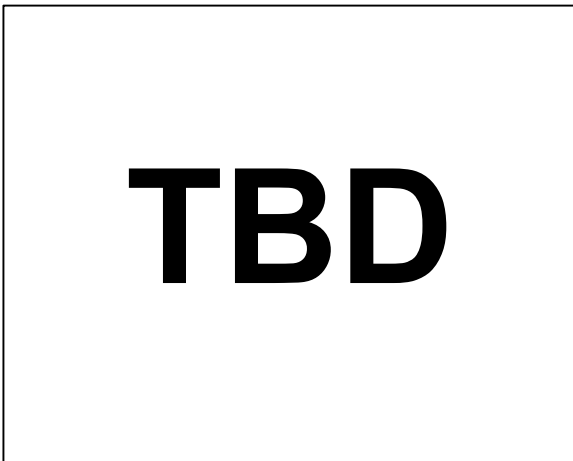

Figure 17. Supply Current vs Output Sink Current

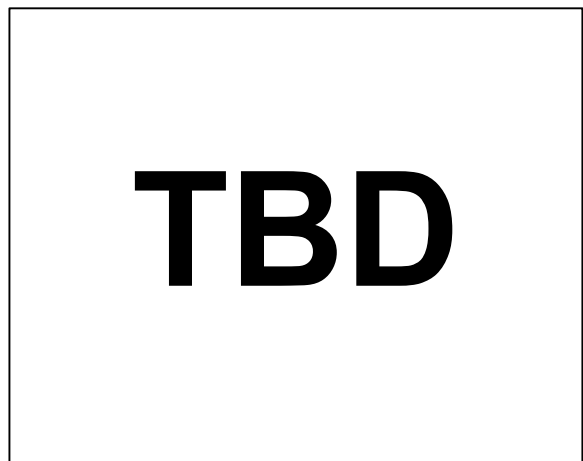

Figure 20 High Level Input Bias Current

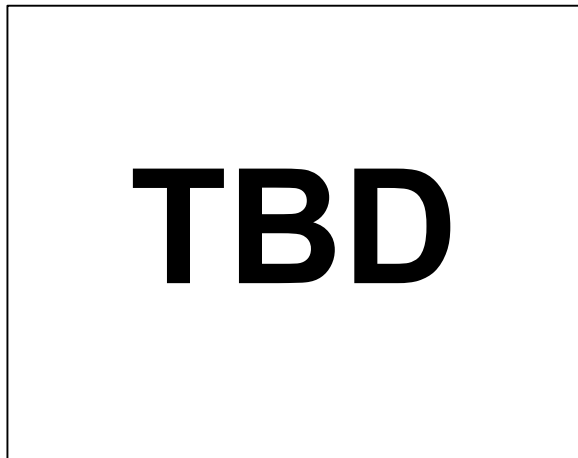

Figure 21. Output Saturation Voltage vs Output Sink Current

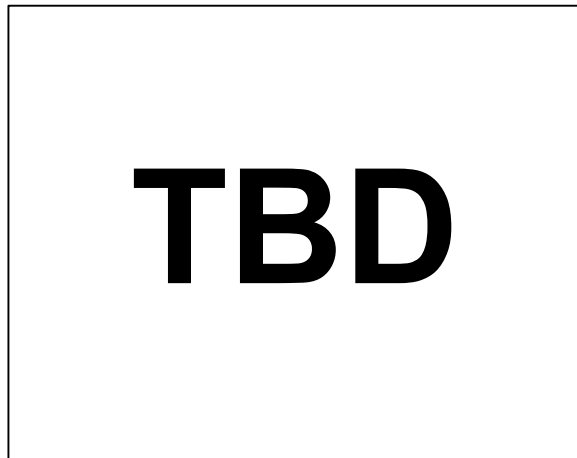

Figure 24. Output Short Circuit Current

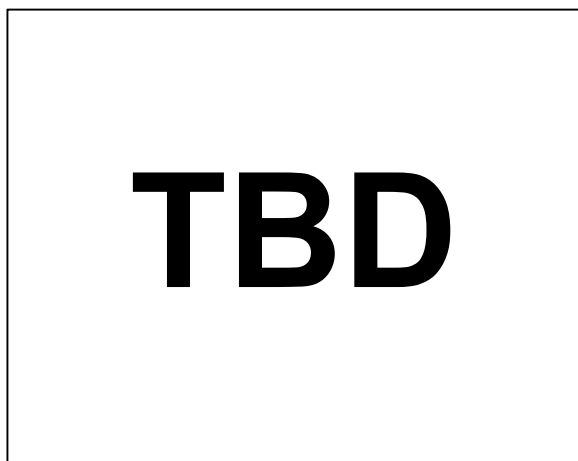

Figure 22 Output Saturation Voltage vs Output Sink Current

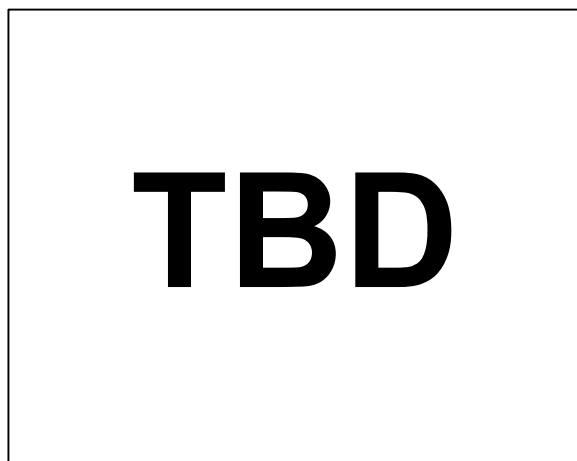

Figure 25. Output Short Circuit Current

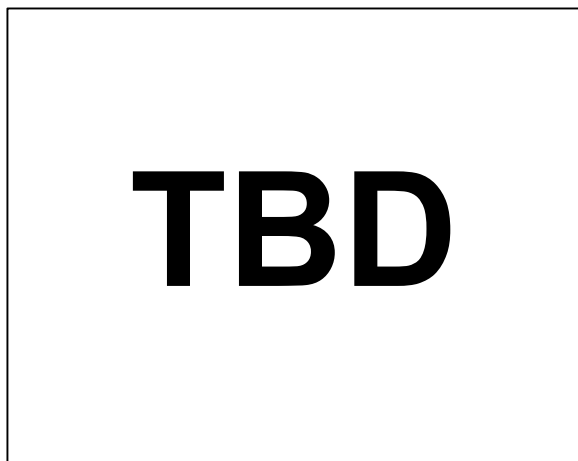

Figure 23. Output Saturation Voltage vs Output Sink Current

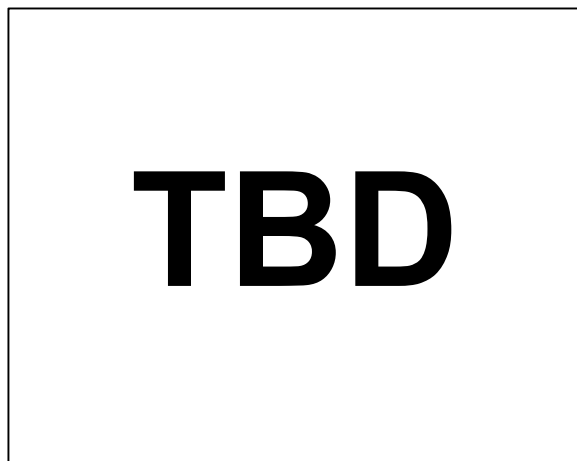

Figure 26. Output Leakage current

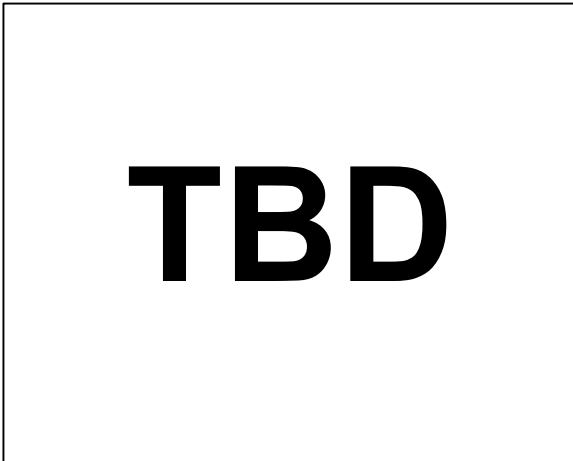

Figure 27. Propagation Delay vs Input Overdrive

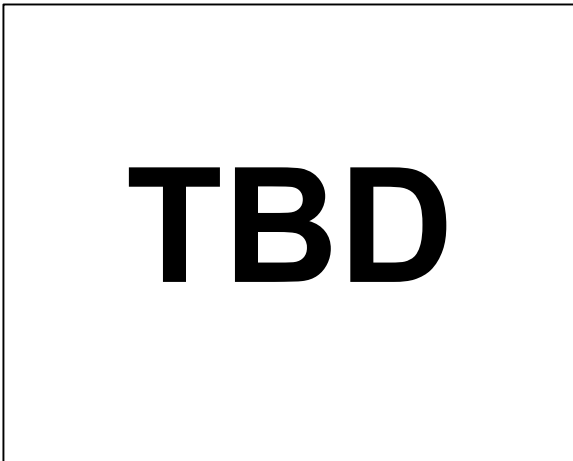

Figure 28. Non Inverting and Inverting comparators Propagation Delay

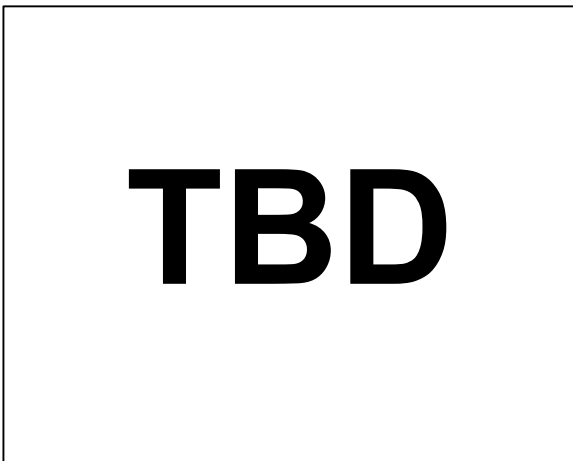

Figure 29. Rise and Fall Times vs Output Pullup Resistor

APPLICATIONS INFORMATION

The ADCMP341/3 is a dual low power comparators with a built in 400mV reference that operates from 1.7V to 5.5V. The comparators are approx 0.8% accurate with fully programmable accurate hysteresis implementing a new technique of a three resistor string on the input. The outputs are open drain capable of sinking up to 40mA.

COMPARATORS AND INTERNAL REFERENCE

Each of the comparators has one input available externally, the other comparator inputs are connected internally to the 400mV reference. The ADCMP341 has two noninverting comparators and the ADCMP343 has two inverting comparators.

There are two input pins available to each comparator. However, these two input pins(IN_x_U, IN_x_L) connect to the same input leg of the comparator via a muxing system. This is to provide fully programmable rising and falling trip points. The output of the said comparator determines which pin is connected to the input of the same comparator. Taking Figure 30. as an example, when OUTA is high INA_U is connected to the comparator input. When the input voltage drops and passes below the 400mV reference the output goes low. This in turn disconnects INA_U from the comparator and connects INA_L. This leg of the string will be at a lower voltage and thus instantaneously the effect of hysteresis is applied. Therefore, using a resistor string on the input as shown in Figure 30., the voltages for the rising and falling trip points can be programmed by selecting the appropriate resistors in the string.

PROGRAMMING HYSTERESIS

The resistor values can be calculated as follows. The total resistance of the string is first determined based on the power budget available. Using the maximum voltage expected on the pin and the maximum acceptable current available to flow through the string¹, the total resistance of the string is calculated as follows:

$$R_{TOT} = \frac{V_{INMAX}}{I_{MAX}}$$

¹ Assuming the leakage current into the comparator to be negligible

Now calculate the three resistor values as follows:

$$R_1 = \frac{R_{TOT} \times (V_{FALLING} - 0.4)}{V_{FALLING}}$$

$$R_3 = \frac{R_{TOT} \times 0.4}{V_{RISING}};$$

$$R_2 = R_{TOT} - R_1 - R_3;$$

Where:

R₁, R₂ and R₃ are the three resistors as shown in Figure 30.

R_{TOT} is the sum of R₁, R₂ and R₃.

V_{FALLING} is the desired falling trip voltage and lower of the two.

V_{RISING} is the desired rising trip voltage and higher of the two.

V_{HYST} is therefore = V_{RISING} - V_{FALLING}

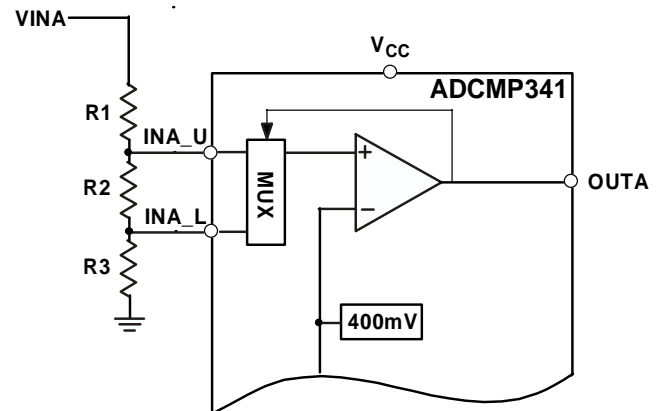

Figure 30.

OUTLINE DIMENSIONS

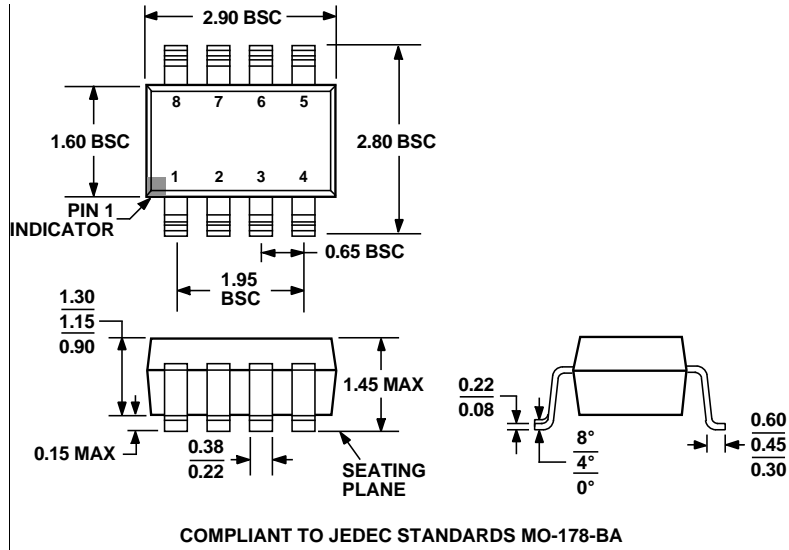

Figure 31. . 8-Lead SOT-23 Package (RJ-8)—Dimensions shown in millimeters

ORDERING GUIDE

Table 4.

Model	Temperature Range	Package Description	Branding	Package Outline
ADCMP341ARJ	-40°C to +125°C	SOT-23, 8 lead		RJ-8
ADCMP343ARJ	-40°C to +125°C	SOT-23, 8 lead		RJ-8

NOTES