



Dual, 12-Bit, 40 MSPS MCM A/D Converter with Analog Input Signal Conditioning

AD10242

FEATURES

Two Matched ADCs with Input Signal Conditioning
Selectable Bipolar Input Voltage Range
(± 0.5 V, ± 1.0 V, ± 2.0 V)
Full MIL-STD-883B Compliant
80 dB Spurious-Free Dynamic Range
Trimmed Channel-Channel Matching

APPLICATIONS

Radar Processing
Communications Receivers
FLIR Processing
Secure Communications
Any I/Q Signal Processing Application

PRODUCT DESCRIPTION

The AD10242 is a complete dual signal chain solution including onboard amplifiers, references, ADCs, and output buffering providing unsurpassed total system performance. Each channel is laser trimmed for gain and offset matching and provides channel-to-channel crosstalk performance better than 80 dB. The AD10242 utilizes two each of the AD9631, OP279, and the AD9042 in a custom MCM to gain space, performance, and cost advantages over solutions previously available.

The AD10242 operates with ± 5.0 V for the analog signal conditioning with a separate $+5.0$ V supply for the analog-to-digital conversion. Each channel is completely independent allowing operation with independent encode or analog inputs. The AD10242 also offers the user a choice of analog input signal ranges to minimize additional signal conditioning required for multiple functions within a single system. The heart of the AD10242 is the AD9042 which is designed specifically for applications requiring wide dynamic range.

The AD10242 is manufactured by Analog Devices on our MIL-PRF-38534 MCM line and is completely qualified. Units are packaged in a custom cofired ceramic 68-lead gull wing package and specified for operation from -55°C to $+125^{\circ}\text{C}$. Contact the factory for additional custom options including those which allow the user to ac couple the ADC directly, bypassing the front end amplifier section. Also see the AD9042 data sheet for additional details on ADC performance.

PRODUCT HIGHLIGHTS

1. Guaranteed sample rate of 40 MSPS.
2. Dynamic performance specified over entire Nyquist band; spurious signals @ 80 dBc for -1 dBFS input signals.
3. Low power dissipation: <2 W off ± 5.0 V supplies.
4. User defined input amplitude.
5. Packaged in 68-lead ceramic leaded chip carrier.

FUNCTIONAL BLOCK DIAGRAM

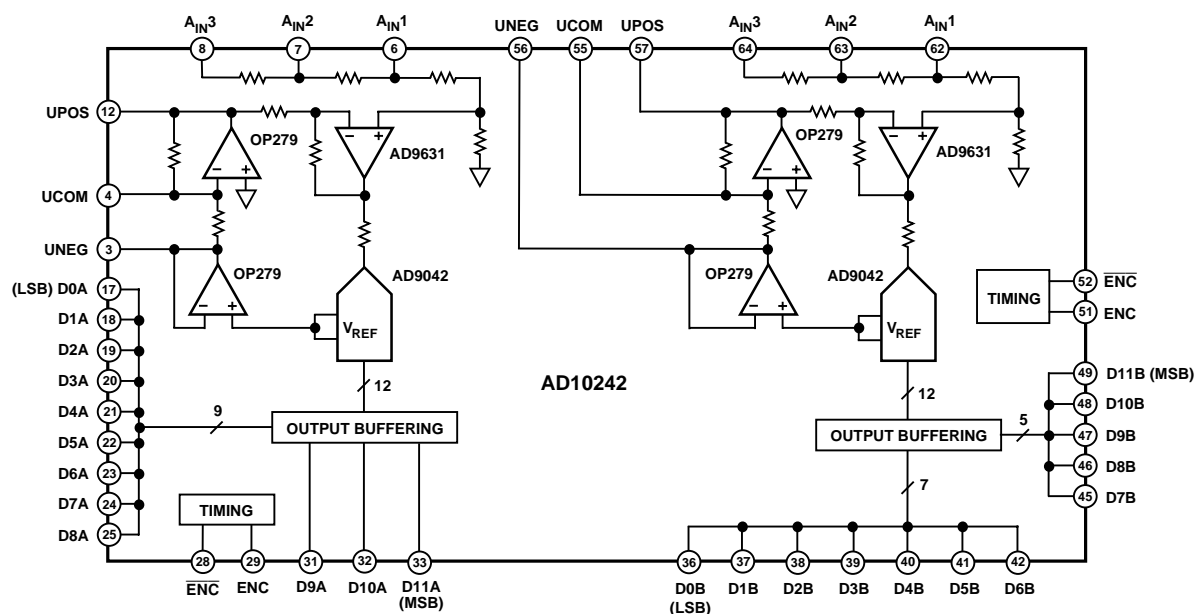

REV. A

Information furnished by Analog Devices is believed to be accurate and reliable. However, no responsibility is assumed by Analog Devices for its use, nor for any infringements of patents or other rights of third parties which may result from its use. No license is granted by implication or otherwise under any patent or patent rights of Analog Devices.

One Technology Way, P.O. Box 9106, Norwood, MA 02062-9106, U.S.A.
Tel: 617/329-4700 World Wide Web Site: <http://www.analog.com>
Fax: 617/326-8703 © Analog Devices, Inc., 1997

AD10242–SPECIFICATIONS

Electrical Characteristics (AV_{CC} = +5 V; AV_{EE} = -5.0 V; DV_{CC} = +5 V; applies to each ADC unless otherwise noted)

Parameter	Temp	Test Level	Mil Subgroup	AD10242BZ/TZ			Units
				Min	Typ	Max	
RESOLUTION					12		Bits
DC ACCURACY					Guaranteed		
No Missing Codes	Full	VI	1, 2, 3				
Offset Error	+25°C	I	1	-0.5	±0.05	+0.5	% FS
	Full	VI	2, 3	-2.0	±1.0	+2.0	% FS
Offset Error Channel Match	Full	V			±0.1		%
Gain Error ¹	+25°C	I	1	-1.0	±0.5	+1.0	% FS
	Full	VI	2, 3	-1.5	±0.8	+1.5	% FS
Gain Error Channel Match	Full	V			±0.1		%
ANALOG INPUT (A _{IN})							
Input Voltage Range							
A _{IN1}	Full	I			±0.5		V
A _{IN2}	Full	I			±1.0		V
A _{IN3}	Full	I			±2		V
Input Resistance							
A _{IN1}	Full	IV	12	99	100	101	Ω
A _{IN2}	Full	IV	12	198	200	202	Ω
A _{IN3}	Full	IV	12	396	400	404	Ω
Input Capacitance ²	+25°C	IV	12	0	4.0	7.0	pF
Analog Input Bandwidth ³	Full	V			60		MHz
ENCODE INPUT ^{4, 5}							
Logic Compatibility					TTL/CMOS		
Logic “1” Voltage	Full	I	1, 2, 3	2.0		5.0	V
Logic “0” Voltage	Full	I	1, 2, 3	0		0.8	V
Logic “1” Current (V _{INH} = 5 V)	Full	I	1, 2, 3		625	800	μA
Logic “0” Current (V _{INL} = 0 V)	Full	I	1, 2, 3	-400	-300		μA
Input Capacitance	+25°C	V	12			7.0	pF
SWITCHING PERFORMANCE							
Maximum Conversion Rate ⁶	Full	VI	4, 5, 6	40	50		MSPS
Minimum Conversion Rate ⁶	Full	V	12			5	MSPS
Aperture Delay (t _A)	+25°C	V			1.0		ns
Aperture Delay Matching	+25°C	V			±2.0		ns
Aperture Uncertainty (Jitter)	+25°C	V			1		ps rms
ENCODE Pulse Width High	+25°C	IV	12	12	10		ns
ENCODE Pulse Width Low	+25°C	IV	12		10	41	ns
Output Delay (t _{OD})	Full	IV	12	10	12	14	ns
SNR ⁷							
Analog Input @ 1.2 MHz	+25°C	V				68	dB
@ 4.85 MHz	+25°C	I	4	63	66		dB
	Full	II	5, 6	62	66		dB
@ 9.9 MHz	+25°C	I	4	63	65		dB
	Full	II	5, 6	62	65		dB
@ 19.5 MHz	+25°C	I	4	60	63		dB
	Full	II	5, 6	59	62		dB
SINAD ⁸							
Analog Input @ 1.2 MHz	+25°C	V			67		dB
@ 4.85 MHz	+25°C	I	4	62	65		dB
	Full	II	5, 6	61	64		dB
@ 9.9 MHz	+25°C	I	4	60	64		dB
	Full	II	5, 6	60	63		dB
@ 19.5 MHz	+25°C	I	4	58	61		dB
	Full	II	5, 6	58	60		dB

Parameter	Temp	Test Level	Mil Subgroup	AD10242BZ/TZ			Units
				Min	Typ	Max	
SPURIOUS-FREE DYNAMIC RANGE ⁹ Analog Input @ 1.2 MHz @ 4.85 MHz @ 9.9 MHz @ 19.5 MHz	+25°C	I			81		dBFS
	+25°C	I	4	70	80		dBFS
	Full	II	5, 6	70	79		dBFS
	+25°C	I	4	63	70		dBFS
	Full	II	5, 6	63	69		dBFS
	+25°C	I	4	60	67		dBFS
Full	II	5, 6	60	66		dBFS	
TWO-TONE IMD REJECTION ¹⁰ F1, F2 @ -7 dBFS	Full	II	4, 5, 6	70	76		dBc
CHANNEL-TO-CHANNEL ISOLATION ¹¹	+25°C	IV	12	75	80		dB
TRANSIENT RESPONSE	+25°C	V			10		ns
LINEARITY Differential Nonlinearity (Encode = 20 MHz) Integral Nonlinearity (Encode = 20 MHz)	+25°C	IV	12		0.3	1.0	LSB
	Full	IV	12		0.5	1.25	LSB
	+25°C	V			0.3		LSB
	Full	V			0.5		LSB
OVERVOLTAGE RECOVERY TIME ¹² V _{IN} = 2.0 × FS V _{IN} = 4.0 × FS	Full	IV	12		50	100	ns
	Full	IV	12		75	200	ns
DIGITAL OUTPUTS Logic Compatibility Logic “1” Voltage ¹³ Logic “0” Voltage ¹⁴ Output Coding	Full	I	1, 2, 3	3.5	CMOS 4.2		V
	Full	I	1, 2, 3		0.45	0.65	V
					Twos Complement		
POWER SUPPLY AV _{CC} Supply Voltage I (AV _{CC}) Current AV _{EE} Supply Voltage I (AV _{EE}) Current DV _{CC} Supply Voltage I (DV _{CC}) Current I _{CC} (Total) Supply Current Power Dissipation (Total) Power Supply Rejection Ratio (PSRR) Pass Band Ripple to 10 MHz	Full	VI			+5.0		V
	Full	V			260		mA
	Full	VI			-5.0		V
	Full	V			55		mA
	Full	VI			+5.0		V
	Full	V			25		mA
	Full	I	1, 2, 3		350	400	mA
	Full	I	1, 2, 3		1.75	2.0	W
	Full	I	7, 8		0.01	0.02	% FSR/% V _S
	Full	IV	12			0.2	dB

NOTES

- ¹ Gain tests are performed on A_{IN3} over specified input voltage range.
- ² Input capacitance specifications combines AD9631 die capacitance + ceramic package capacitance.
- ³ Full power bandwidth is the frequency at which the spectral power of the fundamental frequency (as determined by FFT analysis) is reduced by 3 dB.
- ⁴ ENCODE (Pin 4) driven by single-ended source; ENCODE (Pin 5) bypassed to ground through 0.01 μF capacitor.
- ⁵ ENCODE (Pin 4) may also be driven differentially in conjunction with ENCODE (Pin 5); see “Encoding the AD10242” for details.
- ⁶ Minimum and maximum conversion rates allow for variation in Encode Duty Cycle of 50% ± 5%.
- ⁷ Analog Input signal power at -1 dBFS; signal-to-noise ratio (SNR) is the ratio of signal level to total noise (first 5 harmonics removed). Encode = 40.0 MSPS.
- ⁸ Analog Input signal power at -1 dBFS; signal-to-noise and distortion (SINAD) is the ratio of signal level to total noise + harmonics. Encode = 40.0 MSPS.
- ⁹ Analog Input signal equal -1 dBFS; SFDR is ratio of converter full scale to worst spur.
- ¹⁰ Both input tones at -7 dBFS; two tone intermodulation distortion (IMD) rejection is the ratio of either tone to the worst 3rd order intermod product. f1 = 10.0 MHz ± 100 kHz, 50 kHz ≤ f1 - f2 ≤ 300 kHz.
- ¹¹ Channel-to-channel isolation tested with A channel grounded and a full-scale signal applied to B channel (AIN1).
- ¹² Input driven to 2× and 4× A_{IN1} range for >4 clock cycles. Output recovers inband in specified time with Encode = 40 MSPS. No foldover guaranteed.
- ¹³ Outputs are sourcing 10 μA.
- ¹⁴ Outputs are sinking 10 μA.

All specifications guaranteed within 100 ms of initial power up regardless of sequencing.

Specifications subject to change without notice.

AD10242

ABSOLUTE MAXIMUM RATINGS¹

Parameter	Min	Max	Units
ELECTRICAL			
V _{CC} Voltage	0	7	V
V _{EE} Voltage	-7	0	V
Analog Input Voltage	V _{EE}	V _{CC}	V
Analog Input Current	-10	+10	mA
Digital Input Voltage (ENCODE)	0	V _{CC}	V
ENCODE, $\overline{\text{ENCODE}}$ Differential Voltage		4	V
Digital Output Current	-40	+40	mA
ENVIRONMENTAL²			
Operating Temperature (Case)	-55	+125	°C
Maximum Junction Temperature		+175	°C
Lead Temperature (Soldering, 10 sec)		+300	°C
Storage Temperature Range (Ambient)	-65	+150	°C

NOTES

¹Absolute maximum ratings are limiting values to be applied individually, and beyond which the serviceability of the circuit may be impaired. Functional operability is not necessarily implied. Exposure to absolute maximum rating conditions for an extended period of time may affect device reliability.

² Typical thermal impedances for "Z" package: $\theta_{JC} = 11^\circ\text{C}/\text{W}$; $\theta_{JA} = 30^\circ\text{C}/\text{W}$.

Table I. Output Coding

MSB	LSB	Base 10	Input
01111111111111		2047	+FS
00000000000001		+1	
00000000000000		0	0.0 V
11111111111111		-1	
10000000000000		2048	-FS

EXPLANATION OF TEST LEVELS

Test Level

- I - 100% Production Tested.
- II - 100% production tested at +25°C, and sample tested at specified temperatures. AC testing done on sample basis.
- III - Sample Tested Only.
- IV - Parameter is guaranteed by design and characterization testing.
- V - Parameter is a typical value only.
- VI - All devices are 100% production tested at +25°C; sample tested at temperature extremes.

ORDERING GUIDE

Model	Temperature Range	Package Description	Package Option
AD10242BZ	-40°C to +85°C (Case)	68-Pin Ceramic Leaded Chip Carrier	Z-68A
AD10242TZ	-55°C to +125°C (Case)	68-Pin Ceramic Leaded Chip Carrier	Z-68A
AD10242TZ/883B	-55°C to +125°C (Case)	68-Pin Ceramic Leaded Chip Carrier	Z-68A
5962-9581501HXA	-55°C to +125°C (Case)	68-Pin Ceramic Leaded Chip Carrier	Z-68A
AD10242/PCB	+25°C	Evaluation Board with AD10242BZ	

CAUTION

ESD (electrostatic discharge) sensitive device. Electrostatic charges as high as 4000 V readily accumulate on the human body and test equipment and can discharge without detection. Although the AD10242 features proprietary ESD protection circuitry, permanent damage may occur on devices subjected to high energy electrostatic discharges. Therefore, proper ESD precautions are recommended to avoid performance degradation or loss of functionality.



AD10242

DEFINITION OF SPECIFICATIONS

Analog Bandwidth

The analog input frequency at which the spectral power of the fundamental frequency (as determined by the FFT analysis) is reduced by 3 dB.

Aperture Delay

The delay between the 50% point of the rising edge of the ENCODE command and the instant at which the analog input is sampled.

Aperture Uncertainty (Jitter)

The sample-to-sample variation in aperture delay.

Differential Nonlinearity

The deviation of any code from an ideal 1 LSB step.

Encode Pulse Width/Duty Cycle

Pulse width high is the minimum amount of time that the ENCODE pulse should be left in logic "1" state to achieve rated performance; pulse width low is the minimum time ENCODE pulse should be left in low state. At a given clock rate, these specs define an acceptable Encode duty cycle.

Harmonic Distortion

The ratio of the rms signal amplitude to the rms value of the worst harmonic component.

Integral Nonlinearity

The deviation of the transfer function from a reference line measured in fractions of 1 LSB using a "best straight line" determined by a least square curve fit.

Minimum Conversion Rate

The encode rate at which the SNR of the lowest analog signal frequency drops by no more than 3 dB below the guaranteed limit.

Maximum Conversion Rate

The encode rate at which parametric testing is performed.

Output Propagation Delay

The delay between the 50% point of the rising edge of ENCODE command and the time when all output data bits are within valid logic levels.

Overvoltage Recovery Time

The amount of time required for the converter to recover to 0.02% accuracy after an analog input signal of the specified percentage of full scale is reduced to midscale.

Power Supply Rejection Ratio

The ratio of a change in input offset voltage to a change in power supply voltage.

Signal-to-Noise-and-Distortion (SINAD)

The ratio of the rms signal amplitude (set at 1 dB below full scale) to the rms value of the sum of all other spectral components, including harmonics but excluding dc.

Signal-to-Noise Ratio (without Harmonics)

The ratio of the rms signal amplitude (set at 1 dB below full scale) to the rms value of the sum of all other spectral components, excluding the first five harmonics and dc.

Spurious-Free Dynamic Range

The ratio of the rms signal amplitude to the rms value of the peak spurious spectral component. The peak spurious component may or may not be a harmonic. May be reported in dBc (i.e., degrades as signal levels is lowered) or in dBFS (always related back to converter full scale).

Transient Response

The time required for the converter to achieve 0.02% accuracy when a one-half full-scale step function is applied to the analog input.

Two-Tone Intermodulation Distortion Rejection

The ratio of the rms value of either input tone to the rms value of the worst third order intermodulation product; reported in dBc.

Two-Tone SFDR

The ratio of the rms value of either input tone to the rms value of the peak spurious component. The peak spurious component may or may not be an IMD product. May be reported in dBc (i.e., degrades as signal levels is lowered) or in dBFS (always related back to converter full scale).

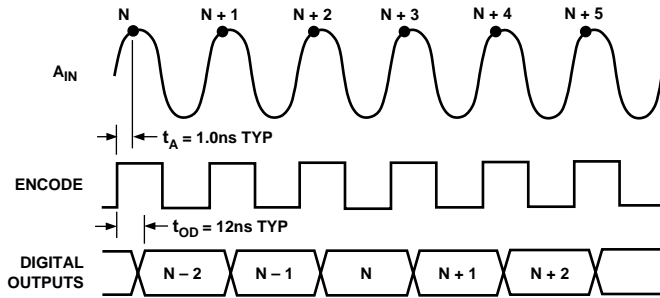

Figure 1. Timing Diagram

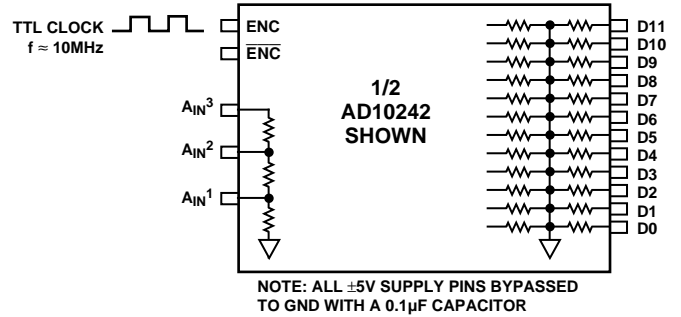

Figure 2. Equivalent Burn-In Circuit

EQUIVALENT CIRCUITS

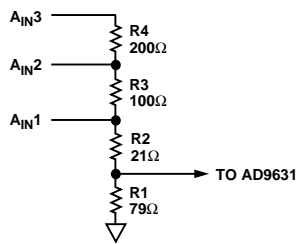

Figure 3. Analog Input Stage

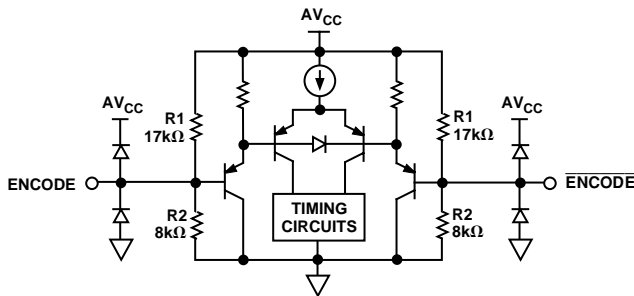

Figure 4. Encode Inputs

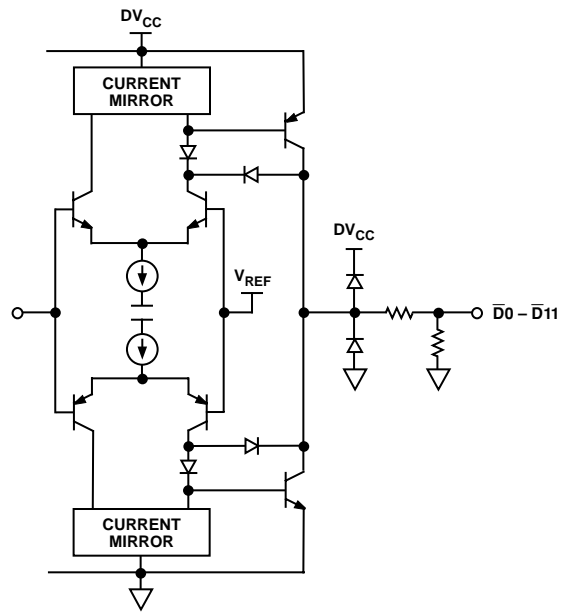

Figure 5. Digital Output Stage

AD10242–Typical Performance Characteristics

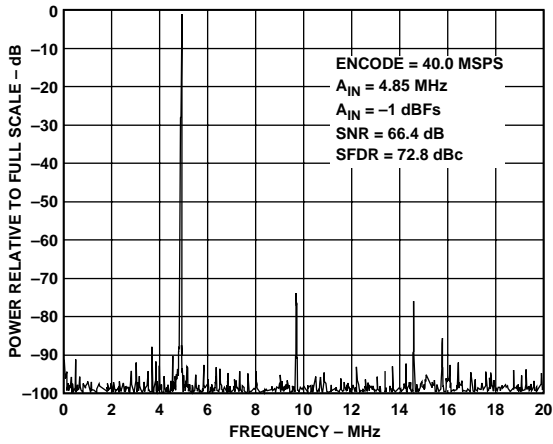

Figure 6. Single Tone @ 4.85 MHz

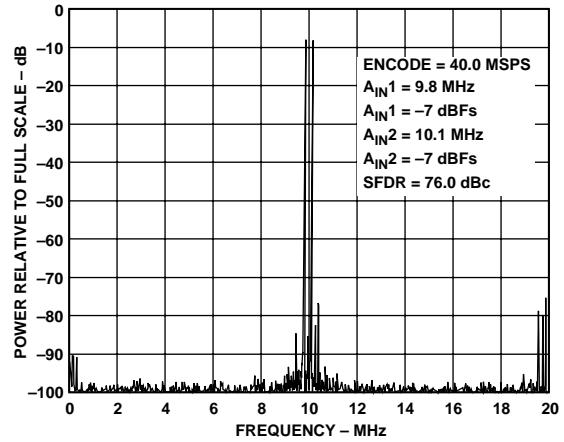

Figure 9. Two Tone FFT @ 9.8/10.1 MHz

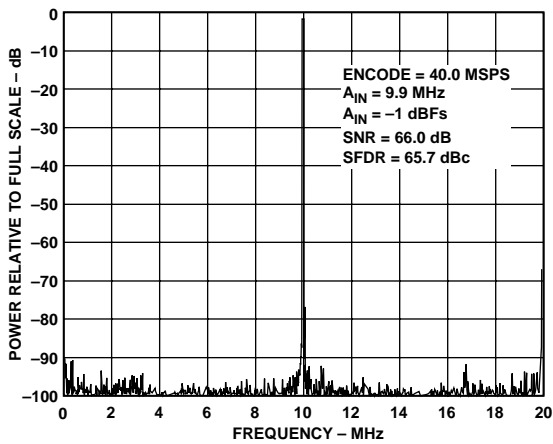

Figure 7. Single Tone @ 9.9 MHz

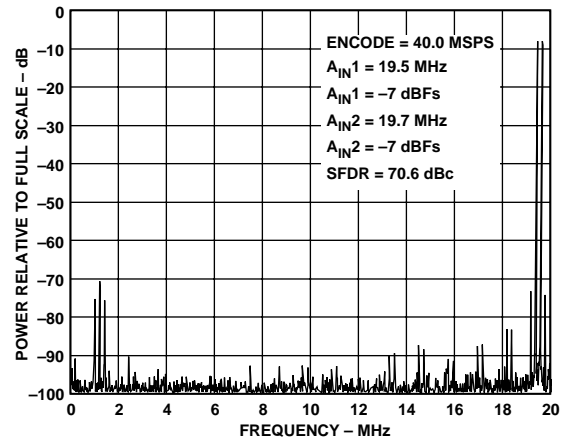

Figure 10. Two Tone FFT @ 19.5/19.7 MHz

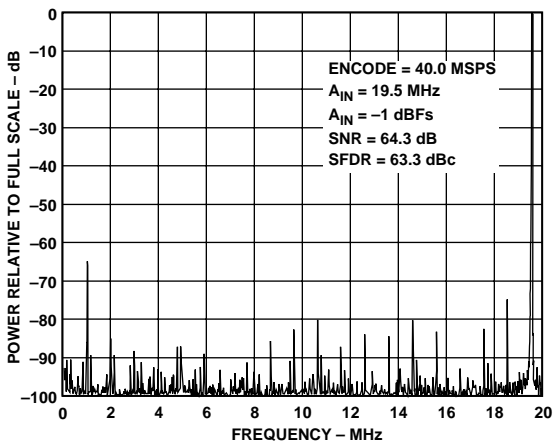

Figure 8. Single Tone @ 19.5 MHz

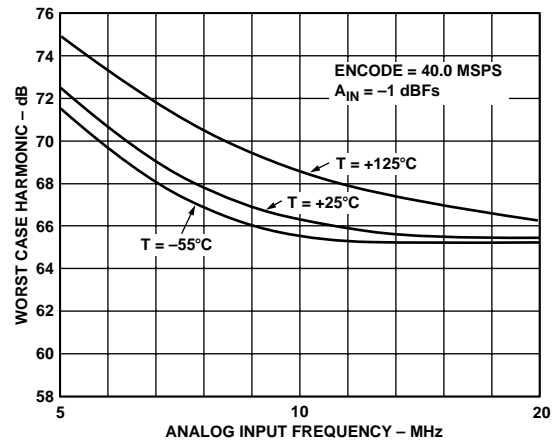

Figure 11. Harmonics vs. AIN

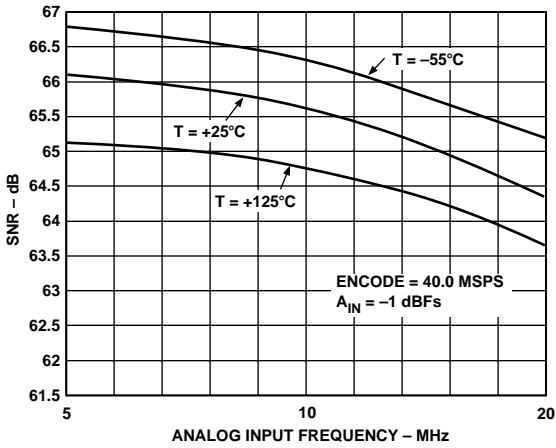

Figure 12. SNR vs. A_{IN}

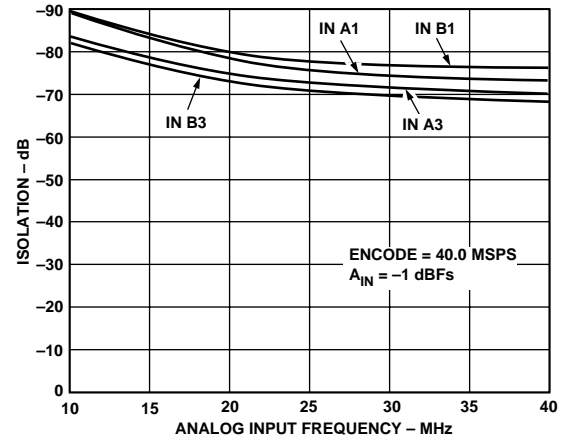

Figure 15. Isolation vs. Frequency

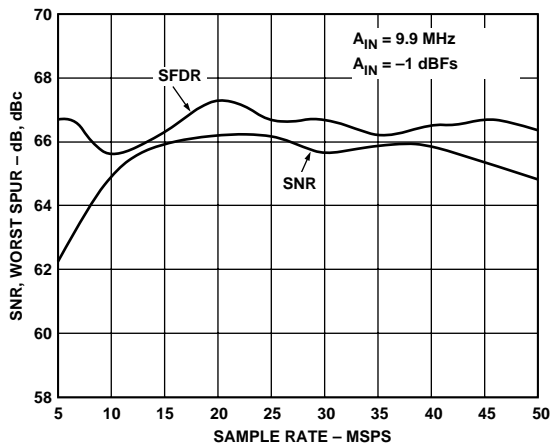

Figure 13. SNR and Harmonics vs. Encode Rate

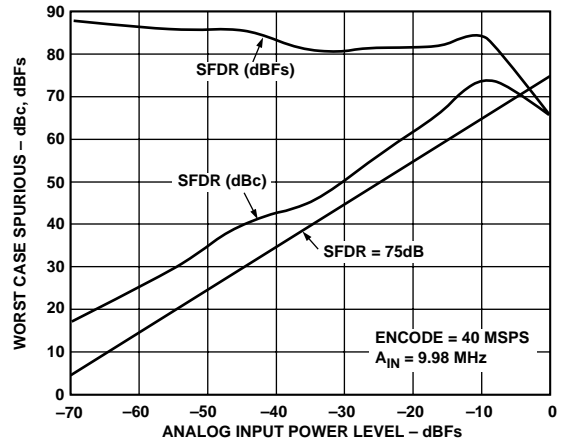

Figure 16. Single Tone SFDR (A_{IN} @ 9.98) vs. Power Level

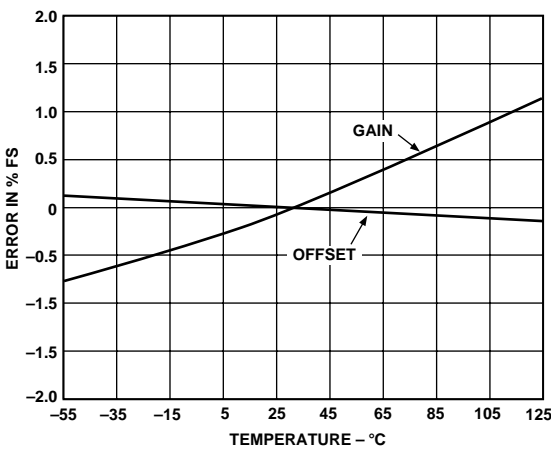

Figure 14. Offset and Gain Error vs. Temperature

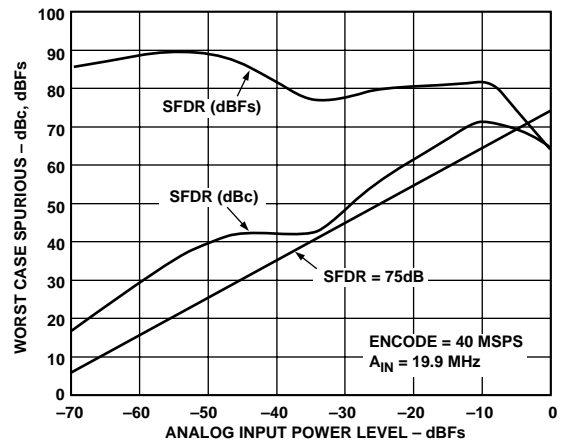

Figure 17. Single Tone SFDR (A_{IN} @ 19.9) vs. Power Level

AD10242—Typical Performance Characteristics

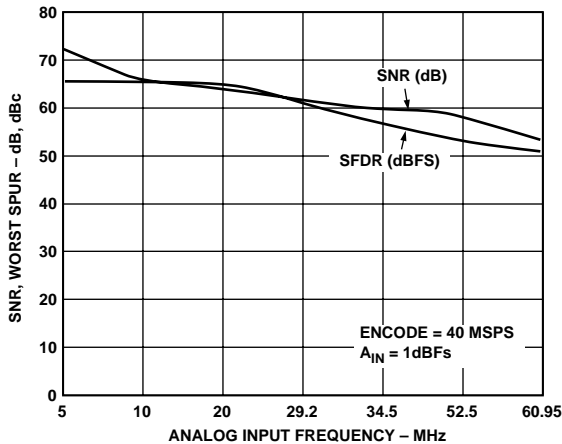

Figure 18. SNR/Harmonics to $A_{IN} > Nyquist$ MSPS

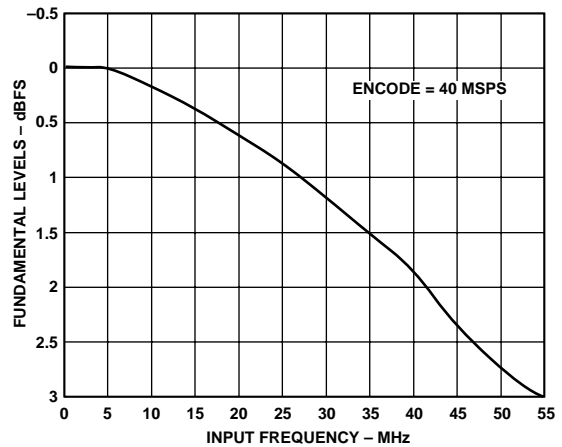

Figure 19. Gain Flatness vs. Input Frequency

THEORY OF OPERATION

Refer to the block diagram. The AD10242 employs three monolithic ADI components per channel (AD9631, OP279, and AD9042), along with multiple passive resistor networks and decoupling capacitors to fully integrate a complete 12-bit analog-to-digital converter.

The input signal is first passed through a precision laser trimmed resistor divider allowing the user to externally select operation with a full scale signal of ± 0.5 V, ± 1.0 V, or ± 2.0 V by choosing the proper input terminal for the application. The result of the resistor divider is to apply a full-scale input of approximately 0.4 V to the noninverting input of the internal AD9631 amplifier.

The AD9631 provides the dc coupled level shift circuit required for operation with the AD9042 ADC. Configuring the amplifier in a noninverting mode the ac signal gain can be trimmed to provide a constant input to the ADC centered around the internal reference voltage of the AD9042. This allows the converter to be used in multiple system applications without the need for external gain and level shift circuitry normally requiring trim. The AD9631 was chosen for its superior ac performance and input drive capabilities which have limited the ability of many amplifiers to drive high performance ADCs. As new amplifiers are developed, pin compatible improvements are planned to incorporate the latest operational amplifier technology.

The OP279 provides the buffer and inversion of the internal reference of the AD9042 in order to supply the summing node of the AD9631 input amplifier. This dc voltage is then summed with the input voltage and applied to the input of the AD9042 ADC. The reference voltage of the AD9042 is designed to track internal offsets and drifts of the ADC and is used to ensure matching over an extended temperature range of operation.

APPLYING THE AD10242

Encoding the AD10242

The AD10242 is designed to interface with TTL and CMOS logic families. The source used to drive the ENCODE pin(s) must be clean and free from jitter. Sources with excessive jitter will limit SNR and overall performance.

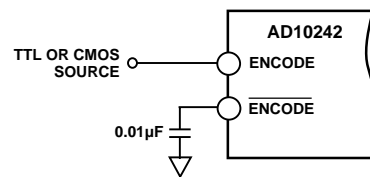

Figure 20. Single-Ended TTL/CMOS Encode

The AD10242 encode inputs are connected to a differential input stage (see Figure 4 under EQUIVALENT CIRCUITS). With no input connected to either the ENCODE or input, the voltage divider bias the inputs to 1.6 volts. For TTL or CMOS usage, the encode source should be connected to ENCODE (Pins 29 and/or 51). $\overline{\text{ENCODE}}$ (Pins 28 and/or 52) should be decoupled using a low inductance or microwave chip capacitor to ground. Devices such as AVX 05085C103MA15, a 0.01 μF capacitor, work well.

Performance Improvements

It is possible to improve the performance of the AD10242 slightly by taking advantage of the internal characteristics of the amplifier and converter combination. By increasing the +5 V supply slightly, the user may be able to gain up to a 5 dB improvement in SFDR over the entire frequency range of the converter. It is not recommended to exceed +5.5 V on the analog supplies as there are no performance benefits beyond that range and care should be taken to avoid the absolute maximum ratings.

If a logic threshold other than the nominal 1.6 V is required, the following equations show how to use an external resistor, R_X , to raise or lower the trip point (see Figure 4, $R_1 = 17\text{ k}\Omega$, $R_2 = 8\text{ k}\Omega$).

$$V_1 = \frac{5R_2R_X}{R_1R_2 + R_1R_X + R_2R_X} \text{ to lower logic threshold.}$$

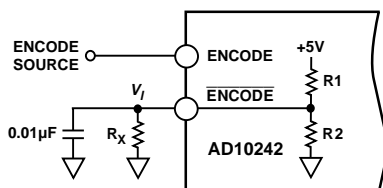

Figure 21. Lower Threshold for Encode

$$V_1 = \frac{5R_2}{R_2 + \frac{R_1R_X}{R_1 + R_X}} \text{ to raise logic threshold.}$$

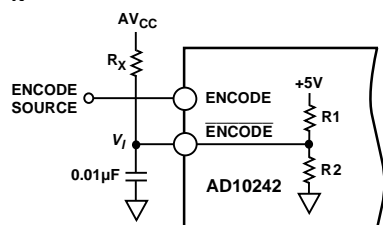

Figure 22. Raise Logic Threshold for Encode

While the single ended encode will work well for many applications, driving the encode differentially will provide increased performance. Depending on circuit layout and system noise, a 1 dB to 3 dB improvement in SNR can be realized. It is recommended that the encode signal be ac-coupled into the ENCODE and $\overline{\text{ENCODE}}$ pins.

The simplest option is shown below. The low jitter TTL signal is coupled with a limiting resistor, typically $100\ \Omega$, to the primary side of an RF transformer (these transformers are inexpensive and readily available; Part No. in figure is from Mini-Circuits). The secondary side is connected to the ENCODE and $\overline{\text{ENCODE}}$ pins of the converter. Since both encode inputs are self-biased, no additional components are required.

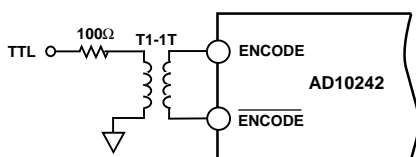

Figure 23. TTL Source—Differential Encode

If no TTL source is available, a clean sine wave may be substituted. In the case of the sine source, the matching network is shown below. Since the matching transformer specified is a 1:1 impedance ratio, R , the load resistor should be selected to match the source impedance. The input impedance of the AD9042 is negligible in most cases.

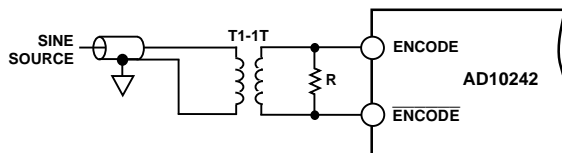

Figure 24. Sine Source—Differential Encode

If a low jitter ECL clock is available, another option is to ac-couple a differential ECL signal to the encode input pins as shown below. The capacitors shown here should be chip capacitors but do not need to be of the low inductance variety.

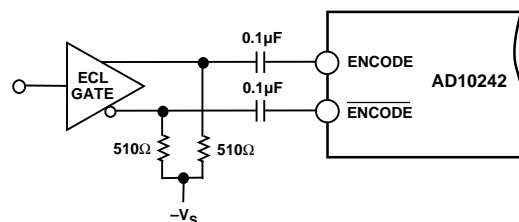

Figure 25. Differential ECL for Encode

As a final alternative, the ECL gate may be replaced by an ECL comparator. The input to the comparator could then be a logic signal or a sine signal.

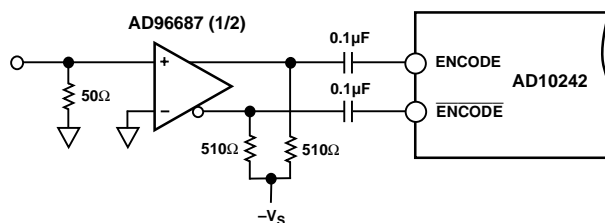

Figure 26. ECL Comparator for Encode

Care should be taken not to overdrive the encode input pin when ac coupled. Although the input circuitry is electrically protected from over or under voltage conditions, improper circuit operations may result from overdriving the encode input pin.

AD10242

USING THE FLEXIBLE INPUT

The AD10242 has been designed with the user's ease of operation in mind. Multiple input configurations have been included on board to allow the user to have a choice of input signal levels and input impedance. While the standard inputs are ± 0.5 V, ± 1.0 V, and ± 2.0 V, the user can select the input impedance of the AD10242 on any input by using the other inputs as alternate locations for GND or an external resistor. The following chart summarizes the impedance options available at each input location:

- $A_{IN1} = 100 \Omega$ when A_{IN2} and A_{IN3} Are Open.
- $A_{IN1} = 75 \Omega$ when A_{IN3} Is Shorted to GND.
- $A_{IN1} = 50 \Omega$ when A_{IN2} Is Shorted to GND.
- $A_{IN2} = 200 \Omega$ when A_{IN3} Is Open.
- $A_{IN2} = 100 \Omega$ when A_{IN3} Is Shorted to GND.
- $A_{IN2} = 75 \Omega$ when A_{IN2} to A_{IN3} Has an External Resistor of 300Ω , with A_{IN3} Shorted to GND.
- $A_{IN2} = 50 \Omega$ when A_{IN2} to A_{IN3} Has an External Resistor of 100Ω , with A_{IN3} Shorted to GND.
- $A_{IN3} = 400 \Omega$.
- $A_{IN3} = 100 \Omega$ when A_{IN3} Has an External Resistor of 133Ω to GND.
- $A_{IN3} = 75 \Omega$ when A_{IN3} Has an External Resistor of 92Ω to GND.
- $A_{IN3} = 50 \Omega$ when A_{IN3} Has an External Resistor of 57Ω to GND.

While the Analog inputs of the AD10242 are designed for dc coupled bipolar inputs, the AD10242 has the ability to use unipolar inputs in a user selectable mode through the addition of an external resistor. This allows for 1 V, 2 V, and 4 V full-scale unipolar signals to be applied to the various inputs (A_{IN1} , A_{IN2} , and A_{IN3} respectively). Placing a 2.43 k Ω resistor (typical, offset calibration required) between UPOS and UCOM shifts the reference voltage setpoint to allow a unipolar positive voltage to be applied at the inputs of the device. To calibrate offset a midscale dc voltage should be applied to the converter while adjusting the unipolar resistor for a midscale output transition.

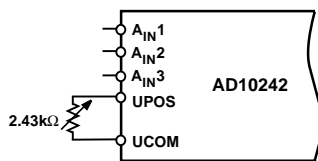

Figure 27. Unipolar Positive

To operate with -1 V, -2 V, or -4 V full-scale unipolar signals place a 2.67 k Ω resistor (typical, offset calibration required) between UNEG and UCOM. This again shifts the reference voltage setpoint to allow a unipolar negative voltage to be applied at the inputs of the device. To calibrate offset a mid-scale dc voltage should be applied to the converter while adjusting the unipolar resistor for a midscale output transition.

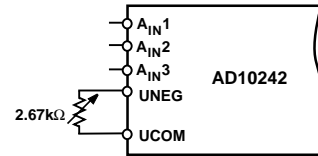

Figure 28. Unipolar Negative

GROUNDING AND DECOUPLING

Analog and Digital Grounding

Proper grounding is essential in any high speed, high resolution system. Multilayer printed circuit boards (PCBs) are recommended to provide optimal grounding and power schemes. The use of ground and power planes offers distinct advantages:

1. The minimization of the loop area encompassed by a signal and its return path.
2. The minimization of the impedance associated with ground and power paths.
3. The inherent distributed capacitor formed by the power plane, PCB insulation, and ground plane.

These characteristics result in both a reduction of electromagnetic interference (EMI) and an overall improvement in performance.

It is important to design a layout that prevents noise from coupling to the input signal. Digital signals should not be run in parallel with input signal traces and should be routed away from the input circuitry. The AD10242 does not distinguish between analog and digital ground pins as the AD10242 should always be treated like an analog component. All ground pins should be connected together directly under the AD10242. The PCB should have a ground plane covering all unused portions of the component side of the board to provide a low impedance path and manage the power and ground currents. The ground plane should be removed from the area near the input pins to reduce stray capacitance.

LAYOUT INFORMATION

The schematic of the evaluation board (Figure 29) represents a typical implementation of the AD10242. The pinout of the AD10242 is very straightforward and facilitates ease of use and the implementation of high frequency/high resolution design practices. It is recommended that high quality ceramic chip capacitors be used to decouple each supply pin to ground directly at the device. All capacitors except the one placed on ENCODE can be standard high quality ceramic chip capacitors. The capacitor used on ENCODE pin must be a low inductance chip capacitor as referenced previously in the data sheet.

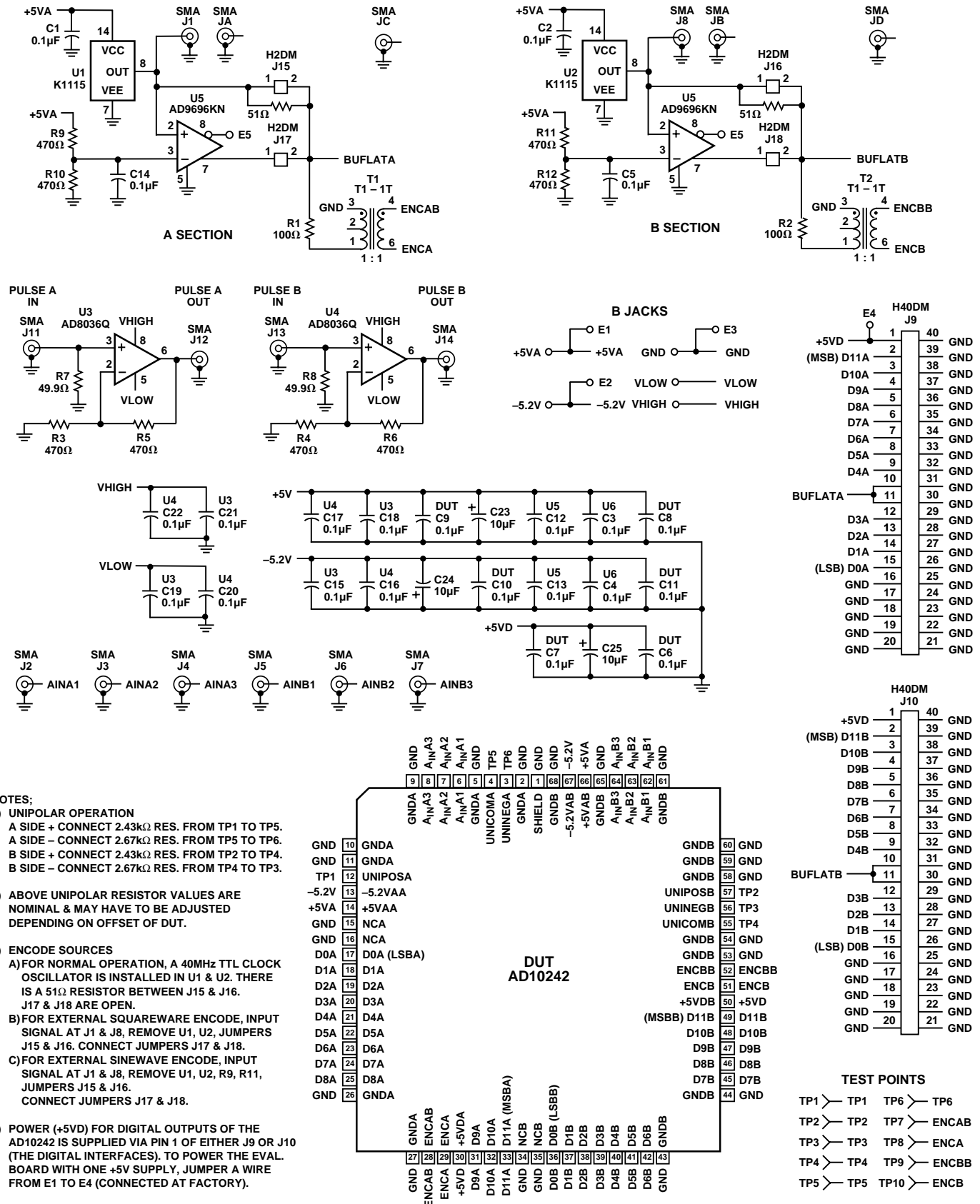

Figure 29. Evaluation Board Schematic

AD10242

Care should be taken when placing the digital output runs. Because the digital outputs have such a high slew rate, the capacitive loading on the digital outputs should be minimized. Circuit traces for the digital outputs should be kept short and connect directly to the receiving gate. Internal circuitry buffers the outputs of the AD9042 ADC through a resistor network to eliminate the need to externally isolate the device from the receiving gate.

EVALUATION BOARD

The AD10242 evaluation board (see Figure 30) is designed to provide optimal performance for evaluation of the AD10242

analog-to-digital converter. The board encompasses everything needed to ensure the highest level of performance for evaluating the AD10242.

Power to the analog supply pins is connected via banana jacks. The analog supply powers the crystal oscillator, the associated components and amplifiers, and the analog section of the AD10242. The Digital outputs of the AD10242 are powered via Pin 1 of either J9 or J10 found on the digital interface connector. To power the evaluation board with one +5 V supply a jumper wire is required from test point E1 to E4. Contact the factory if additional layout or applications assistance is required.

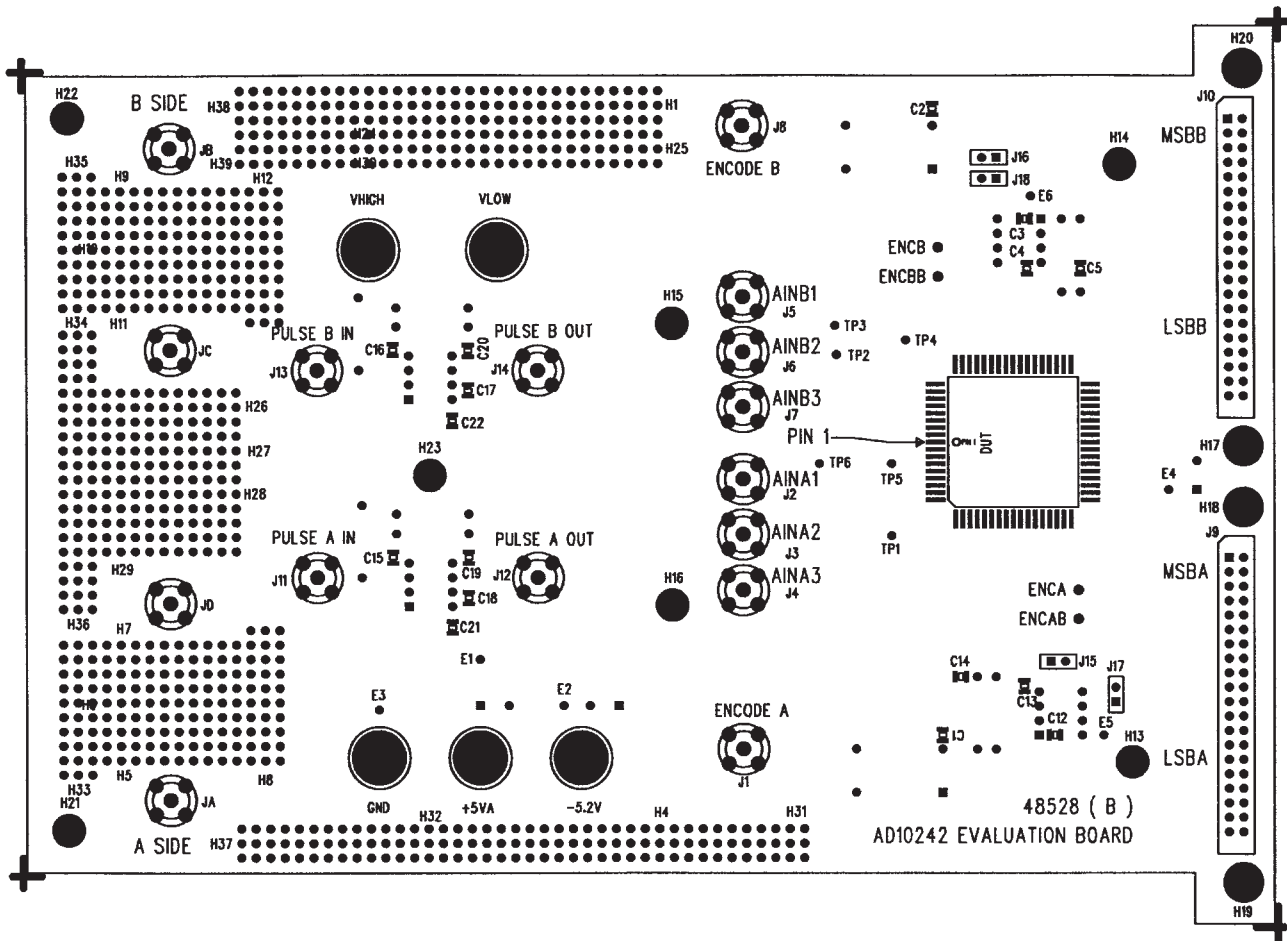

Figure 30. Evaluation Board Mechanical Layout

OUTLINE DIMENSIONS

Dimensions shown in inches and (mm).

**68-Lead Ceramic Leaded Chip Carrier
(Z-68A)**

