

OP-27

FEATURES

- **Low Noise** $80\text{nV}_{\text{p-p}}$ (0.1Hz to 10Hz)
..... $3\text{nV}/\sqrt{\text{Hz}}$
- **Low Drift** $0.2\mu\text{V}/^\circ\text{C}$
- **High Speed** $2.8\text{V}/\mu\text{s}$ Slew Rate
..... **8MHz Gain Bandwidth**
- **Low V_{OS}** $10\mu\text{V}$
- **Excellent CMRR** **126dB** at V_{CM} of $\pm 11\text{V}$
- **High Open-Loop Gain** **1.8 Million**
- **Fits 725, OP-07, OP-05, AD510, AD517, 5534A sockets**
- **Available in Die Form**

ORDERING INFORMATION[†]

$T_{\text{A}} = +25^\circ\text{C}$ $V_{\text{OS MAX}}$ (μV)	PACKAGE				OPERATING TEMPERATURE RANGE
	TO-99	CERDIP 8-PIN	PLASTIC 8-PIN	LCC 20-CONTACT	
25	OP27AJ*	OP27AZ*	-	-	MIL
25	OP27EJ	OP27EZ	OP27EP	-	IND/COM
60	OP27BJ*	OP27BZ*	-	OP27BR/883	MIL
60	OP27FJ	OP27FZ	OP27FP	-	IND/COM
100	OP27CJ	OP27CZ	-	-	MIL
100	OP27GJ	OP27GZ	OP27GP	-	XIND
100	-	-	OP27GS ^{††}	-	XIND

* For devices processed in total compliance to MIL-STD-883, add /883 after part number. Consult factory for 883 data sheet.

[†] Burn-in is available on commercial and industrial temperature range parts in CerDIP, plastic DIP, and TO-can packages.

^{††} For availability and burn-in information on SO and PLCC packages, contact your local sales office.

GENERAL DESCRIPTION

The OP-27 precision operational amplifier combines the low offset and drift of the OP-07 with both high speed and low noise. Offsets down to $25\mu\text{V}$ and drift of $0.6\mu\text{V}/^\circ\text{C}$ maximum make the OP-27 ideal for precision instrumentation applications. Exceptionally low noise, $e_n = 3.5\text{nV}/\sqrt{\text{Hz}}$, at 10Hz, a low 1/f noise corner frequency of 2.7Hz, and high gain (1.8 million), allow accurate high-gain amplification of low-level

signals. A gain-bandwidth product of 8MHz and a $2.8\text{V}/\mu\text{sec}$ slew rate provides excellent dynamic accuracy in high-speed data-acquisition systems.

A low input bias current of $\pm 10\text{nA}$ is achieved by use of a bias-current-cancellation circuit. Over the military temperature range, this circuit typically holds I_{B} and I_{OS} to $\pm 20\text{nA}$ and 15nA respectively.

The output stage has good load driving capability. A guaranteed swing of $\pm 10\text{V}$ into 600Ω and low output distortion make the OP-27 an excellent choice for professional audio applications.

PSRR and CMRR exceed 120dB. These characteristics, coupled with long-term drift of $0.2\mu\text{V}/\text{month}$, allow the circuit designer to achieve performance levels previously attained only by discrete designs.

PIN CONNECTIONS

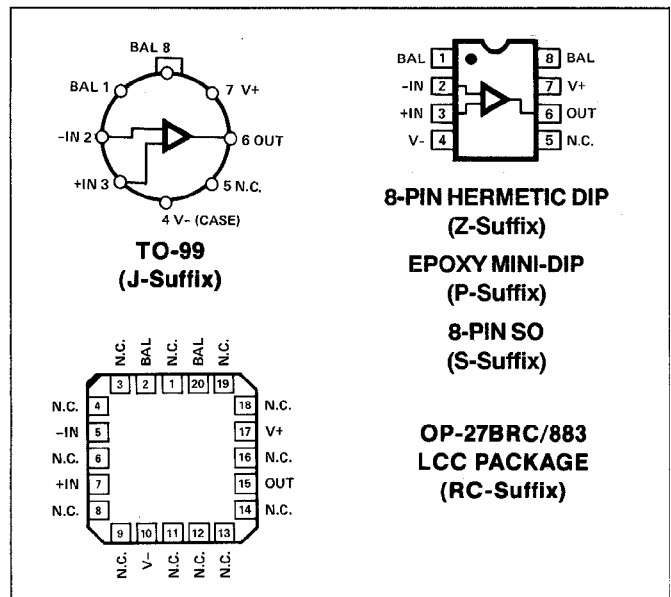

SIMPLIFIED SCHEMATIC

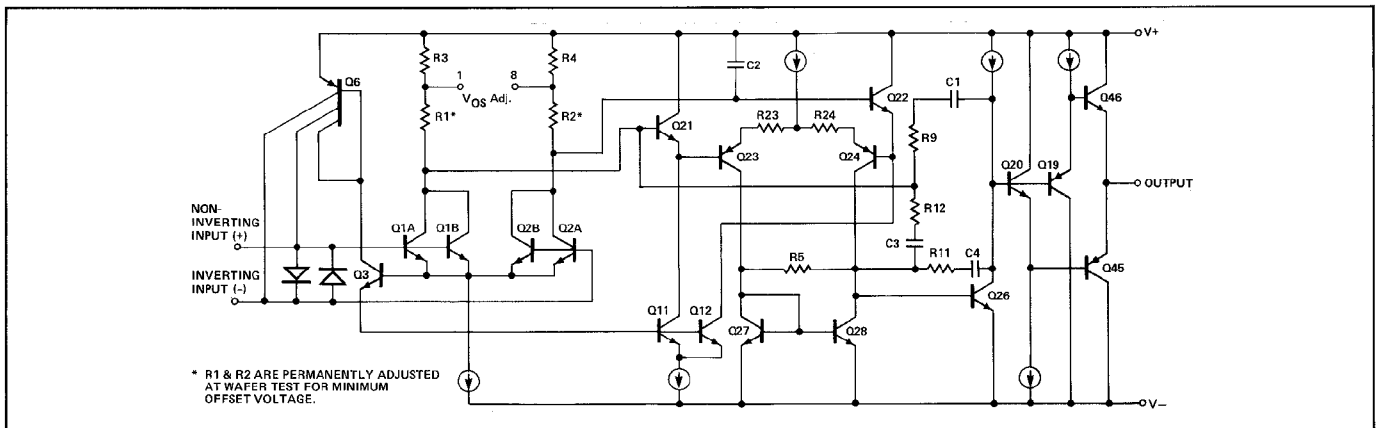

OP-27

Low cost, high-volume production of OP-27 is achieved by using an on-chip zener-zap trimming network. This reliable and stable offset trimming scheme has proved its effectiveness over many years of production history.

The OP-27 provides excellent performance in low-noise high-accuracy amplification of low-level signals. Applications include stable integrators, precision summing amplifiers, precision voltage-threshold detectors, comparators, and professional audio circuits such as tape-head and microphone preamplifiers.

The OP-27 is a direct replacement for 725, OP-06, OP-07 and OP-05 amplifiers; 741 types may be directly replaced by removing the 741's nulling potentiometer.

ABSOLUTE MAXIMUM RATINGS (Note 4)

Supply Voltage	±22V
Input Voltage (Note 1)	±22V
Output Short-Circuit Duration	Indefinite
Differential Input Voltage (Note 2)	±0.7V
Differential Input Current (Note 2)	±25mA
Storage Temperature Range	-65°C to +150°C

Operating Temperature Range

OP-27A, OP-27B, OP-27C (J, Z, RC)	-55°C to +125°C
OP-27E, OP-27F (J, Z)	-25°C to +85°C
OP-27E, OP-27F (P)	0°C to +70°C
OP-27G (P, S, J, Z)	-40°C to +85°C
Lead Temperature Range (Soldering, 60 sec)	300°C
Junction Temperature	-65°C to +150°C

PACKAGE TYPE	θ_{JA} (Note 3)	θ_{JC}	UNITS
TO-99 (J)	150	18	°C/W
8-Pin Hermetic DIP (Z)	148	16	°C/W
8-Pin Plastic DIP (P)	103	43	°C/W
20-Contact LCC (RC)	98	38	°C/W
8-Pin SO (S)	158	43	°C/W

NOTES:

- For supply voltages less than ±22V, the absolute maximum input voltage is equal to the supply voltage.
- The OP-27's inputs are protected by back-to-back diodes. Current limiting resistors are not used in order to achieve low noise. If differential input voltage exceeds ±0.7V, the input current should be limited to 25mA.
- θ_{JA} is specified for worst case mounting conditions, i.e., θ_{JA} is specified for device in socket for TO, CerDIP, P-DIP, and LCC packages; θ_{JA} is specified for device soldered to printed circuit board for SO package.
- Absolute maximum ratings apply to both DICE and packaged parts, unless otherwise noted.

ELECTRICAL CHARACTERISTICS at $V_S = \pm 15V$, $T_A = 25^\circ C$, unless otherwise noted.

PARAMETER	SYMBOL	CONDITIONS	OP-27A/E			OP-27B/F			OP-27C/G			UNITS
			MIN	TYP	MAX	MIN	TYP	MAX	MIN	TYP	MAX	
Input Offset Voltage	V_{OS}	(Note 1)	—	10	25	—	20	60	—	30	100	μV
Long-Term V_{OS} Stability	$V_{OS}/Time$	(Notes 2, 3)	—	0.2	1.0	—	0.3	1.5	—	0.4	2.0	$\mu V/Mo$
Input Offset Current	I_{OS}		—	7	35	—	9	50	—	12	75	nA
Input Bias Current	I_B		—	±10	±40	—	±12	±55	—	±15	±80	nA
Input Noise Voltage	e_{np-p}	0.1Hz to 10Hz (Notes 3, 5)	—	0.08	0.18	—	0.08	0.18	—	0.09	0.25	$\mu Vp-p$
Input Noise Voltage Density	e_n	$f_O = 10Hz$ (Note 3)	—	3.5	5.5	—	3.5	5.5	—	3.8	8.0	nV/\sqrt{Hz}
		$f_O = 30Hz$ (Note 3)	—	3.1	4.5	—	3.1	4.5	—	3.3	5.6	
		$f_O = 1000Hz$ (Note 3)	—	3.0	3.8	—	3.0	3.8	—	3.2	4.5	
Input Noise Current Density	i_n	$f_O = 10Hz$ (Notes 3, 6)	—	1.7	4.0	—	1.7	4.0	—	1.7	—	pA/\sqrt{Hz}
		$f_O = 30Hz$ (Notes 3, 6)	—	1.0	2.3	—	1.0	2.3	—	1.0	—	
		$f_O = 1000Hz$ (Notes 3, 6)	—	0.4	0.6	—	0.4	0.6	—	0.4	0.6	
Input Resistance — Differential-Mode	R_{IN}	(Note 7)	1.3	6	—	0.94	5	—	0.7	4	—	M Ω
Input Resistance — Common-Mode	R_{INCM}		—	3	—	—	2.5	—	—	2	—	G Ω
Input Voltage Range	IVR		±11.0	±12.3	—	±11.0	±12.3	—	±11.0	±12.3	—	V
Common-Mode Rejection Ratio	CMRR	$V_{CM} = \pm 11V$	114	126	—	106	123	—	100	120	—	dB
Power Supply Rejection Ratio	PSRR	$V_S = \pm 4V$ to $\pm 18V$	—	1	10	—	1	10	—	2	20	$\mu V/V$
Large-Signal Voltage Gain	A_{VO}	$R_L \geq 2k\Omega$, $V_O = \pm 10V$	1000	1800	—	1000	1800	—	700	1500	—	V/mV
		$R_L \geq 600\Omega$, $V_O = \pm 10V$	800	1500	—	800	1500	—	600	1500	—	
Output Voltage Swing	V_O	$R_L \geq 2k\Omega$	±12.0	±13.8	—	±12.0	±13.8	—	±11.5	±13.5	—	V
		$R_L \geq 600\Omega$	±10.0	±11.5	—	±10.0	±11.5	—	±10.0	±11.5	—	
Slew Rate	SR	$R_L \geq 2k\Omega$ (Note 4)	1.7	2.8	—	1.7	2.8	—	1.7	2.8	—	V/ μs

ELECTRICAL CHARACTERISTICS at $V_S = \pm 15V$, $T_A = 25^\circ C$, unless otherwise noted. (Continued)

PARAMETER	SYMBOL	CONDITIONS	OP-27A/E			OP-27B/F			OP-27C/G			UNITS
			MIN	TYP	MAX	MIN	TYP	MAX	MIN	TYP	MAX	
Gain Bandwidth Prod.	GBW	(Note 4)	5.0	8.0	—	5.0	8.0	—	5.0	8.0	—	MHz
Open-Loop Output Resistance	R_O	$V_O = 0, I_O = 0$	—	70	—	—	70	—	—	70	—	Ω
Power Consumption	P_d	V_O	—	90	140	—	90	140	—	100	170	mW
Offset Adjustment Range		$R_P = 10k\Omega$	—	± 4.0	—	—	± 4.0	—	—	± 4.0	—	mV

NOTES:

- Input offset voltage measurements are performed ~ 0.5 seconds after application of power. A/E grades guaranteed fully warmed-up.
- Long-term input offset voltage stability refers to the average trend line of V_{OS} vs. Time over extended periods after the first 30 days of operation. Excluding the initial hour of operation, changes in V_{OS} during the first 30 days are typically $2.5\mu V$ — refer to typical performance curve.
- Sample tested.
- Guaranteed by design.
- See test circuit and frequency response curve for 0.1Hz to 10Hz tester.
- See test circuit for current noise measurement.
- Guaranteed by input bias current.

ELECTRICAL CHARACTERISTICS for $V_S = \pm 15V$, $-55^\circ C \leq T_A \leq +125^\circ C$, unless otherwise noted.

PARAMETER	SYMBOL	CONDITIONS	OP-27A			OP-27B			OP-27C			UNITS
			MIN	TYP	MAX	MIN	TYP	MAX	MIN	TYP	MAX	
Input Offset Voltage	V_{OS}	(Note 1)	—	30	60	—	50	200	—	70	300	μV
Average Input Offset Drift	TCV_{OS} TCV_{OSn}	(Note 2) (Note 3)	—	0.2	0.6	—	0.3	1.3	—	0.4	1.8	$\mu V/^\circ C$
Input Offset Current	I_{OS}		—	15	50	—	22	85	—	30	135	nA
Input Bias Current	I_B		—	± 20	± 60	—	± 28	± 95	—	± 35	± 150	nA
Input Voltage Range	IVR		± 10.3	± 11.5	—	± 10.3	± 11.5	—	± 10.2	± 11.5	—	V
Common-Mode Rejection Ratio	CMRR	$V_{CM} = \pm 10V$	108	122	—	100	119	—	94	116	—	dB
Power Supply Rejection Ratio	PSRR	$V_S = \pm 4.5V$ to $\pm 18V$	—	2	16	—	2	20	—	4	51	$\mu V/V$
Large-Signal Voltage Gain	A_{VO}	$R_L \geq 2k\Omega, V_O = \pm 10V$	600	1200	—	500	1000	—	300	800	—	V/mV
Output Voltage Swing	V_O	$R_L \geq 2k\Omega$	± 11.5	± 13.5	—	± 11.0	± 13.2	—	± 10.5	± 13.0	—	V

ELECTRICAL CHARACTERISTICS at $V_S = \pm 15V$, $-25^\circ C \leq T_A \leq +85^\circ C$ for OP-27J and OP-27Z, $0^\circ C \leq T_A \leq +70^\circ C$ for OP-27EP, FP and $-40^\circ C \leq T_A \leq +85^\circ C$ for OP-27GP, GS, unless otherwise noted.

PARAMETER	SYMBOL	CONDITIONS	OP-27E			OP-27F			OP-27G			UNITS
			MIN	TYP	MAX	MIN	TYP	MAX	MIN	TYP	MAX	
Input Offset Voltage	V_{OS}		—	20	50	—	40	140	—	55	220	μV
Average Input Offset Drift	TCV_{OS} TCV_{OSn}	(Note 2) (Note 3)	—	0.2	0.6	—	0.3	1.3	—	0.4	1.8	$\mu V/^\circ C$
Input Offset Current	I_{OS}		—	10	50	—	14	85	—	20	135	nA
Input Bias Current	I_B		—	± 14	± 60	—	± 18	± 95	—	± 25	± 150	nA
Input Voltage Range	IVR		± 10.5	± 11.8	—	± 10.5	± 11.8	—	± 10.5	± 11.8	—	V
Common-Mode Rejection Ratio	CMRR	$V_{CM} = \pm 10V$	110	124	—	102	121	—	96	118	—	dB
Power Supply Rejection Ratio	PSRR	$V_S = \pm 4.5V$ to $\pm 18V$	—	2	15	—	2	16	—	2	32	$\mu V/V$
Large-Signal Voltage Gain	A_{VO}	$R_L \geq 2k\Omega, V_O = \pm 10V$	750	1500	—	700	1300	—	450	1000	—	V/mV
Output Voltage Swing	V_O	$R_L \geq 2k\Omega$	± 11.7	± 13.6	—	± 11.4	± 13.5	—	± 11.0	± 13.3	—	V

NOTES:

- Input offset voltage measurements are performed by automated test equipment approximately 0.5 seconds after application of power. A/E grades guaranteed fully warmed-up.
- The TCV_{OS} performance is within the specifications unnullled or when nulled with $R_P = 8k\Omega$ to $20k\Omega$. TCV_{OS} is 100% tested for A/E grades, sample tested for B/C/F/G grades.
- Guaranteed by design.

OP-27

DICE CHARACTERISTICS

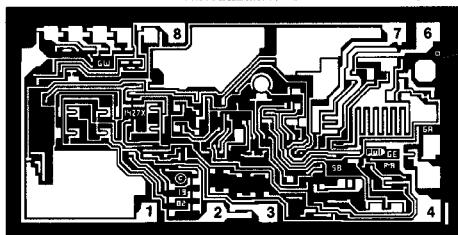

DIE SIZE 0.109 × 0.055 inch, 5995 sq. mils
(2.77 × 1.40mm, 3.88 sq. mm)

1. NULL
2. (-) INPUT
3. (+) INPUT
4. V-
6. OUTPUT
7. V+
8. NULL

WAFER TEST LIMITS at $V_S = \pm 15V$, $T_A = 25^\circ C$ for OP-27N, OP-27G, and OP-27GR devices; $T_A = 125^\circ C$ for OP-27NT and OP-27GT devices, unless otherwise noted.

PARAMETER	SYMBOL	CONDITIONS	OP-27NT LIMIT	OP-27N LIMIT	OP-27GT LIMIT	OP-27G LIMIT	OP-27GR LIMIT	UNITS
Input Offset Voltage	V_{OS}	(Note 1)	60	35	200	60	100	μV MAX
Input Offset Current	I_{OS}		50	35	85	50	75	nA MAX
Input Bias Current	I_B		± 60	± 40	± 95	± 55	± 80	nA MAX
Input Voltage Range	IVR		± 10.3	± 11	± 10.3	± 11	± 11	V MIN
Common-Mode Rejection Ratio	CMRR	$V_{CM} = IVR$	108	114	100	106	100	dB MIN
Power Supply Rejection Ratio	PSRR	$V_S = \pm 4V$ to $\pm 18V$	—	10	—	10	20	$\mu V/V$ MAX
Large-Signal Voltage Gain	A_{VO}	$R_L \geq 2k\Omega$, $V_O = \pm 10V$	600	1000	500	1000	700	V/mV MIN
		$R_L \geq 600\Omega$, $V_O = \pm 10V$	—	800	—	800	600	
Output Voltage Swing	V_O	$R_L \geq 2k\Omega$	± 11.5	± 12.0	± 11.0	± 12.0	± 11.5	V MIN
		$R_L \geq 600\Omega$	—	± 10.0	—	± 10.0	± 10.0	
Power Consumption	P_d	$V_O = 0$	—	140	—	140	170	mW MAX

NOTE:

Electrical tests are performed at wafer probe to the limits shown. Due to variations in assembly methods and normal yield loss, yield after packaging is not guaranteed for standard product dice. Consult factory to negotiate specifications based on dice lot qualification through sample lot assembly and testing.

TYPICAL ELECTRICAL CHARACTERISTICS at $V_S = \pm 15V$, $T_A = +25^\circ C$, unless otherwise noted.

PARAMETER	SYMBOL	CONDITIONS	OP-27N TYPICAL	OP-27G TYPICAL	OP-27GR TYPICAL	UNITS
Average Input Offset Voltage Drift	TCV_{OS} or TCV_{OSn}	Nullled or Unnullled $R_P = 8k\Omega$ to $20k\Omega$	0.2	0.3	0.4	$\mu V/^\circ C$
Average Input Offset Current Drift	TCI_{OS}		80	130	180	$pA/^\circ C$
Average Input Bias Current Drift	TCI_B		100	160	200	$pA/^\circ C$
Input Noise Voltage Density	e_n	$f_O = 10Hz$	3.5	3.5	3.8	nV/\sqrt{Hz}
		$f_O = 30Hz$	3.1	3.1	3.3	
		$f_O = 1000Hz$	3.0	3.0	3.2	
Input Noise Current Density	i_n	$f_O = 10Hz$	1.7	1.7	1.7	pA/\sqrt{Hz}
		$f_O = 30Hz$	1.0	1.0	1.0	
		$f_O = 1000Hz$	0.4	0.4	0.4	
Input Noise Voltage	e_{np-p}	0.1Hz to 10Hz	0.08	0.08	0.09	μV_{p-p}
Slew Rate	SR	$R_L \geq 2k\Omega$	2.8	2.8	2.8	V/ μs
Gain Bandwidth Product	GBW		8	8	8	MHz

NOTE:

1. Input offset voltage measurements are performed by automated test equipment approximately 0.5 seconds after application of power.

TYPICAL PERFORMANCE CHARACTERISTICS

0.1Hz TO 10Hz_{p-p} NOISE TESTER FREQUENCY RESPONSE

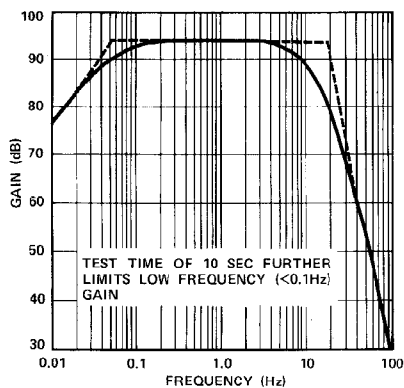

VOLTAGE NOISE DENSITY vs FREQUENCY

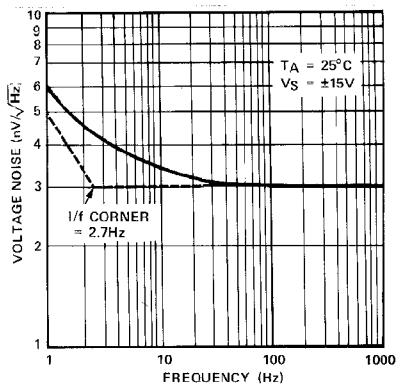

A COMPARISON OF OP AMP VOLTAGE NOISE SPECTRA

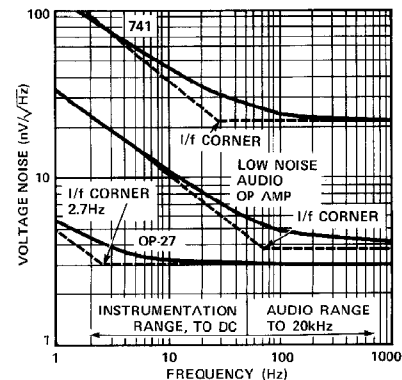

INPUT WIDEBAND VOLTAGE NOISE vs BANDWIDTH (0.1Hz TO FREQUENCY INDICATED)

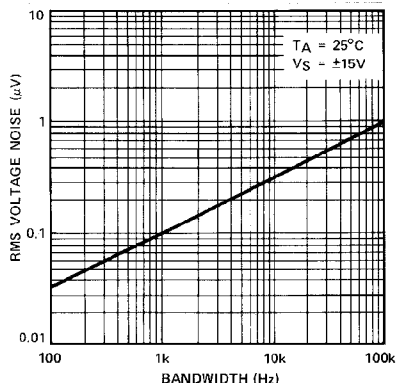

TOTAL NOISE vs SOURCE RESISTANCE

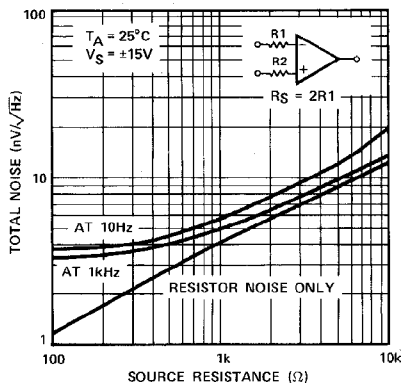

VOLTAGE NOISE DENSITY vs TEMPERATURE

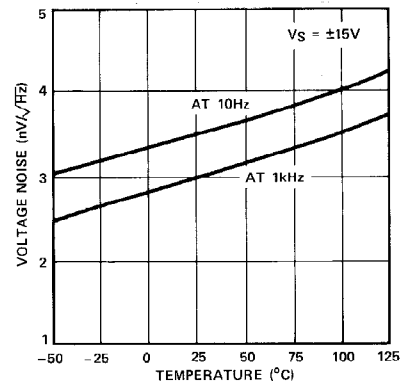

VOLTAGE NOISE DENSITY vs SUPPLY VOLTAGE

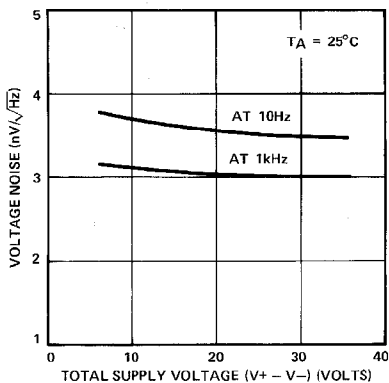

CURRENT NOISE DENSITY vs FREQUENCY

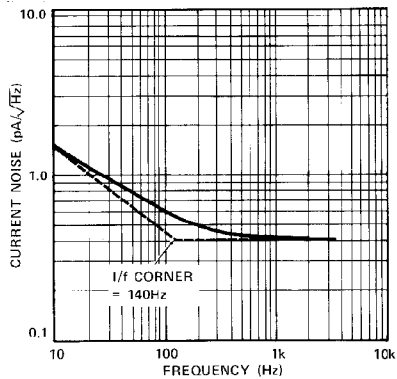

SUPPLY CURRENT vs SUPPLY VOLTAGE

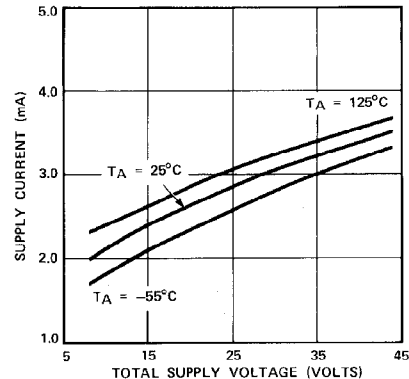

OP-27

TYPICAL PERFORMANCE CHARACTERISTICS

OFFSET VOLTAGE DRIFT OF EIGHT REPRESENTATIVE UNITS vs TEMPERATURE

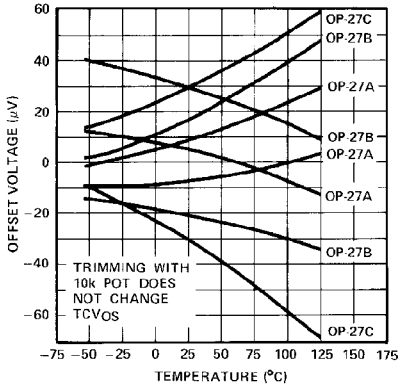

LONG-TERM OFFSET VOLTAGE DRIFT OF SIX REPRESENTATIVE UNITS

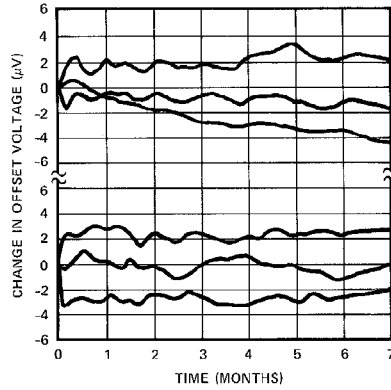

WARM-UP OFFSET VOLTAGE DRIFT

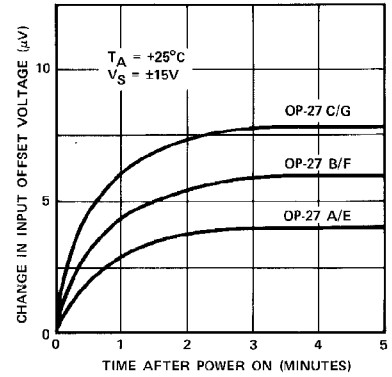

OFFSET VOLTAGE CHANGE DUE TO THERMAL SHOCK

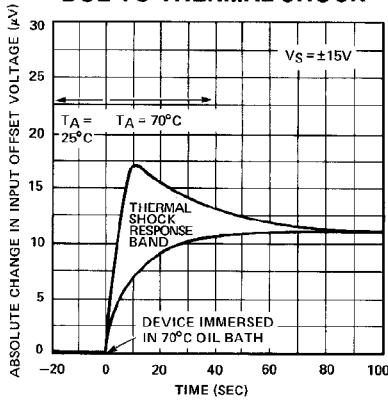

INPUT BIAS CURRENT vs TEMPERATURE

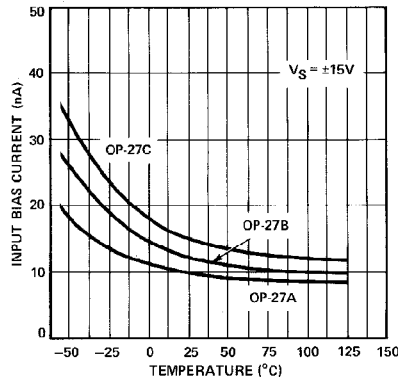

INPUT OFFSET CURRENT vs TEMPERATURE

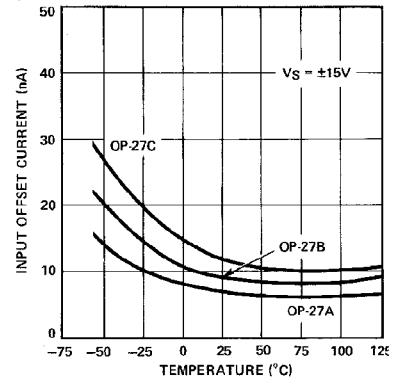

OPEN-LOOP GAIN vs FREQUENCY

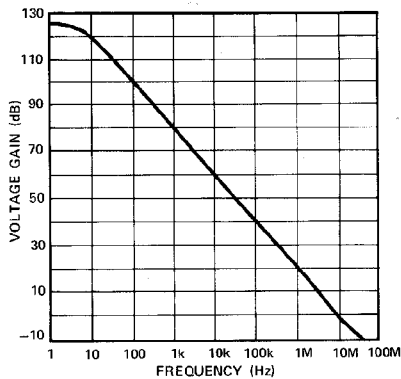

SLEW RATE, GAIN-BANDWIDTH PRODUCT, PHASE MARGIN vs TEMPERATURE

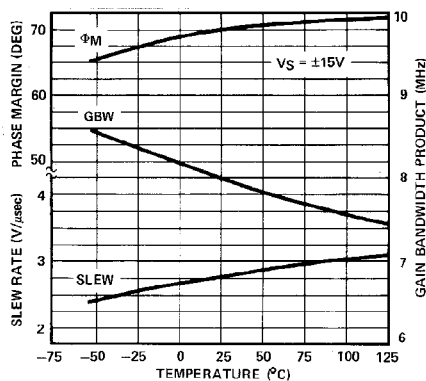

GAIN, PHASE SHIFT vs FREQUENCY

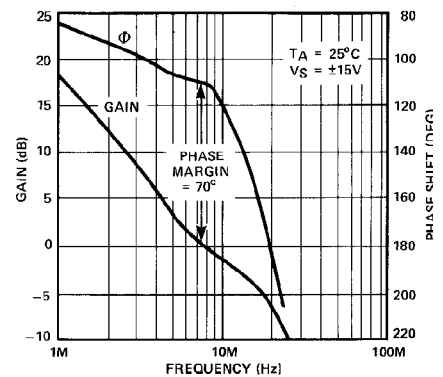

TYPICAL PERFORMANCE CHARACTERISTICS

OPEN-LOOP VOLTAGE GAIN vs SUPPLY VOLTAGE

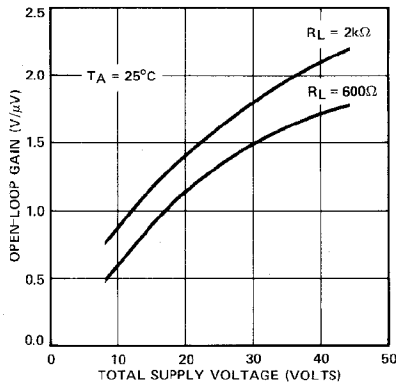

MAXIMUM OUTPUT SWING vs FREQUENCY

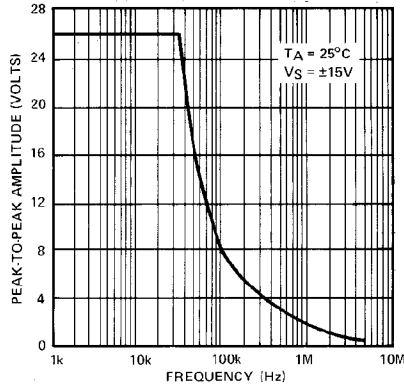

MAXIMUM OUTPUT VOLTAGE vs LOAD RESISTANCE

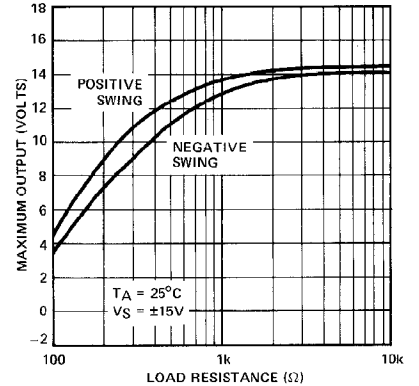

SMALL-SIGNAL OVERSHOOT vs CAPACITIVE LOAD

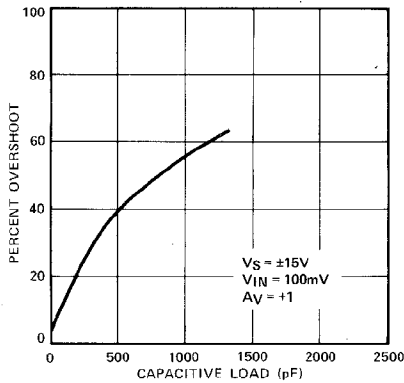

SMALL-SIGNAL TRANSIENT RESPONSE

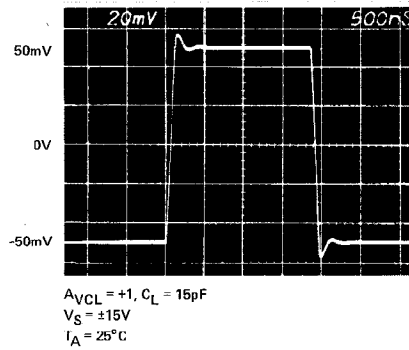

LARGE-SIGNAL TRANSIENT RESPONSE

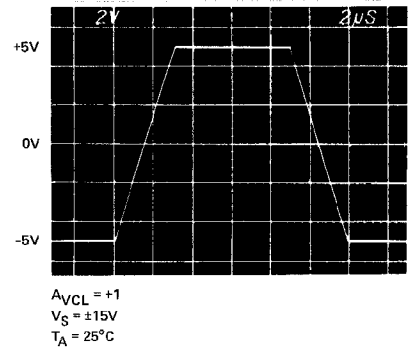

SHORT-CIRCUIT CURRENT vs TIME

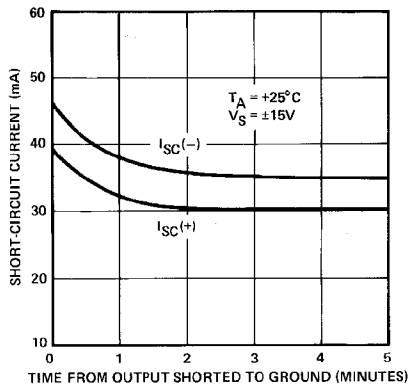

CMRR vs FREQUENCY

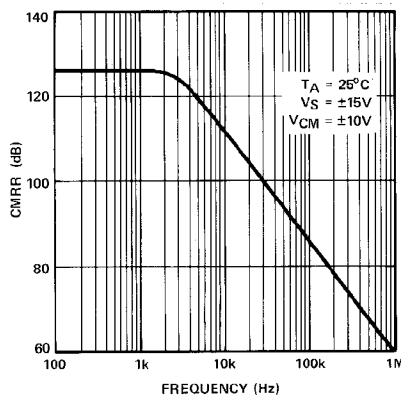

COMMON-MODE INPUT RANGE vs SUPPLY VOLTAGE

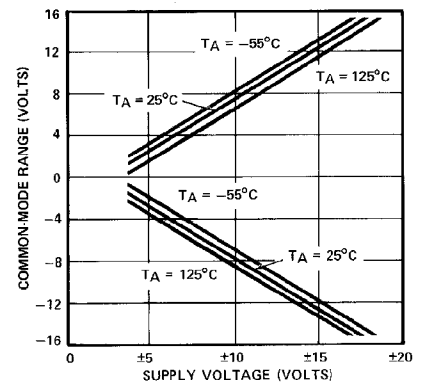

OP-27

TYPICAL PERFORMANCE CHARACTERISTICS

VOLTAGE NOISE TEST CIRCUIT (0.1Hz-TO-10Hz)

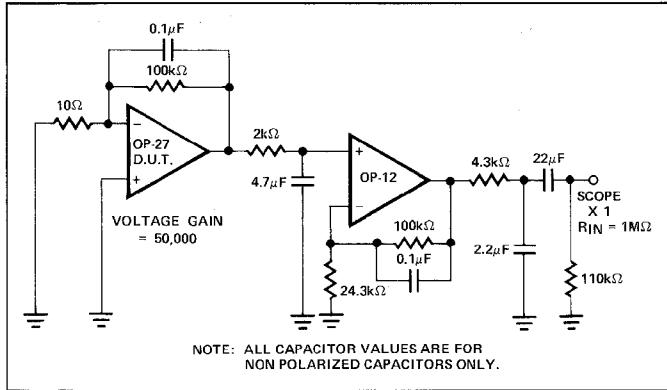

LOW-FREQUENCY NOISE

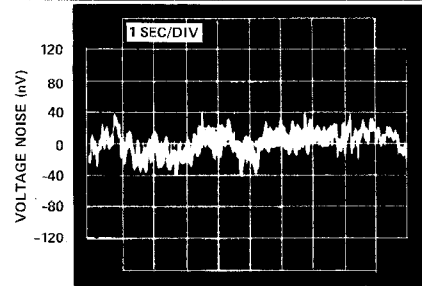

0.1Hz TO 10Hz PEAK-TO-PEAK NOISE

NOTE:

Observation time limited to 10 seconds.

OPEN-LOOP VOLTAGE GAIN vs LOAD RESISTANCE

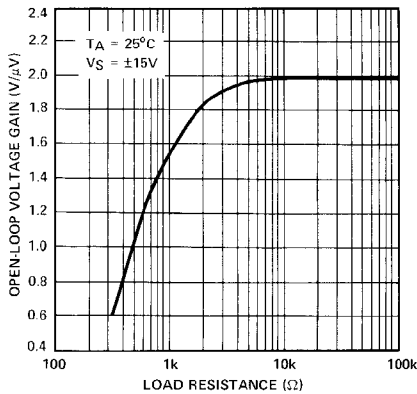

PSRR vs FREQUENCY

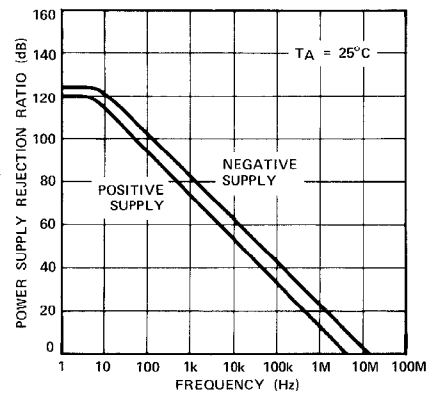

APPLICATIONS INFORMATION

OP-27 Series units may be inserted directly into 725, OP-06, OP-07 and OP-05 sockets with or without removal of external compensation or nulling components. Additionally, the OP-27 may be fitted to unnullled 741-type sockets; however, if conventional 741 nulling circuitry is in use, it should be modified or removed to ensure correct OP-27 operation. OP-27 offset voltage may be nulled to zero (or other desired setting) using a potentiometer (see Offset Nulling Circuit).

The OP-27 provides stable operation with load capacitances of up to 2000pF and $\pm 10V$ swings; larger capacitances should be decoupled with a 50Ω resistor inside the feedback loop. The OP-27 is unity-gain stable.

Thermoelectric voltages generated by dissimilar metals at the input terminal contacts can degrade the drift performance. Best operation will be obtained when both input contacts are maintained at the same temperature.

OFFSET VOLTAGE ADJUSTMENT

The input offset voltage of the OP-27 is trimmed at wafer level. However, if further adjustment of V_{OS} is necessary, a 10kΩ trim potentiometer may be used. TCV_{OS} is not degraded

(see Offset Nulling Circuit). Other potentiometer values from 1kΩ to 1MΩ can be used with a slight degradation (0.1 to $0.2\mu V/^{\circ}C$) of TCV_{OS} . Trimming to a value other than zero creates a drift of approximately $(V_{OS}/300)\mu V/^{\circ}C$. For example, the change in TCV_{OS} will be $0.33\mu V/^{\circ}C$ if V_{OS} is adjusted to 100μV. The offset-voltage adjustment range with a 10kΩ potentiometer is $\pm 4mV$. If smaller adjustment range is required, the nulling sensitivity can be reduced by using a smaller pot in conjunction with fixed resistors. For example, the network below will have a $\pm 280\mu V$ adjustment range.

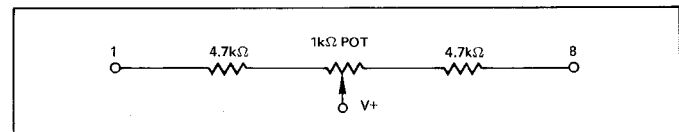

NOISE MEASUREMENTS

To measure the 80nV peak-to-peak noise specification of the OP-27 in the 0.1Hz to 10Hz range, the following precautions must be observed:

- (1) The device has to be warmed-up for at least five minutes. As shown in the warm-up drift curve, the offset voltage

typically changes $4\mu\text{V}$ due to increasing chip temperature after power-up. In the 10-second measurement interval, these temperature-induced effects can exceed tens-of-nanovolts.

- (2) For similar reasons, the device has to be well-shielded from air currents. Shielding minimizes thermocouple effects.
- (3) Sudden motion in the vicinity of the device can also "feed-through" to increase the observed noise.
- (4) The test time to measure 0.1Hz-to-10Hz noise should not exceed 10 seconds. As shown in the noise-tester frequency-response curve, the 0.1Hz corner is defined by only one zero. The test time of 10 seconds acts as an additional zero to eliminate noise contributions from the frequency band below 0.1Hz.
- (5) A noise-voltage-density test is recommended when measuring noise on a large number of units. A 10Hz noise-voltage-density measurement will correlate well with a 0.1Hz-to-10Hz peak-to-peak noise reading, since both results are determined by the white noise and the location of the $1/f$ corner frequency.

UNITY-GAIN BUFFER APPLICATIONS

When $R_f \leq 100\Omega$ and the input is driven with a fast, large signal pulse ($> 1\text{V}$), the output waveform will look as shown in the pulsed operation diagram below.

During the fast feedthrough-like portion of the output, the input protection diodes effectively short the output to the input and a current, limited only by the output short-circuit protection, will be drawn by the signal generator. With $R_f \geq 500\Omega$, the output is capable of handling the current requirements ($I_L \leq 20\text{mA}$ at 10V); the amplifier will stay in its active mode and a smooth transition will occur.

When $R_f > 2\text{k}\Omega$, a pole will be created with R_f and the amplifier's input capacitance (8pF) that creates additional phase shift and reduces phase margin. A small capacitor (20 to 50pF) in parallel with R_f will eliminate this problem.

PULSED OPERATION

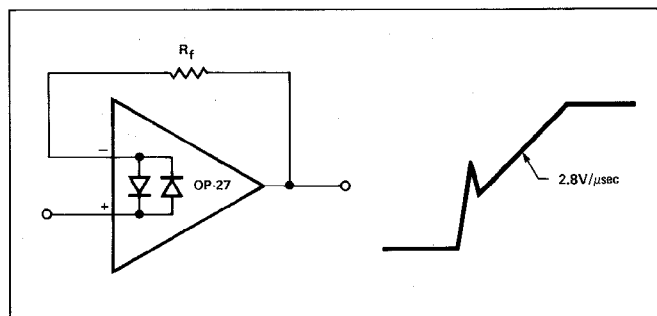

COMMENTS ON NOISE

The OP-27 is a very low-noise monolithic op amp. The outstanding input voltage noise characteristics of the OP-27 are achieved mainly by operating the input stage at a high quiescent current. The input bias and offset currents, which would normally increase, are held to reasonable values by the input-

bias-current cancellation circuit. The OP-27A/E has I_B and I_{OS} of only $\pm 40\text{nA}$ and 35nA respectively at 25°C . This is particularly important when the input has a high source-resistance. In addition, many audio amplifier designers prefer to use direct coupling. The high I_B , V_{OS} , TCV_{OS} of previous designs have made direct coupling difficult, if not impossible, to use.

Voltage noise is inversely proportional to the square-root of bias current, but current noise is proportional to the square-root of bias current. The OP-27's noise advantage disappears when high source-resistors are used. Figures 1, 2, and 3 compare OP-27 observed total noise with the noise performance of other devices in different circuit applications.

$$\text{Total noise} = [(\text{Voltage noise})^2 + (\text{current noise} \times R_S)^2 + (\text{resistor noise})^2]^{1/2}$$

Figure 1 shows noise-versus-source-resistance at 1000Hz . The same plot applies to wideband noise. To use this plot, just multiply the vertical scale by the square-root of the bandwidth.

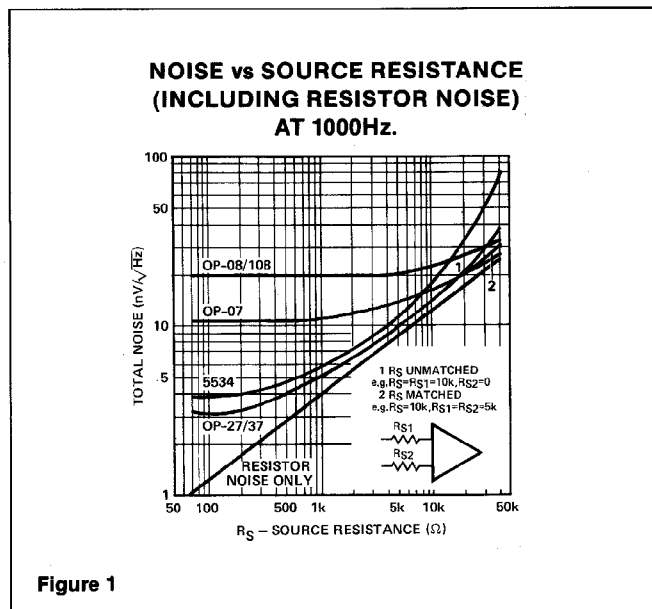
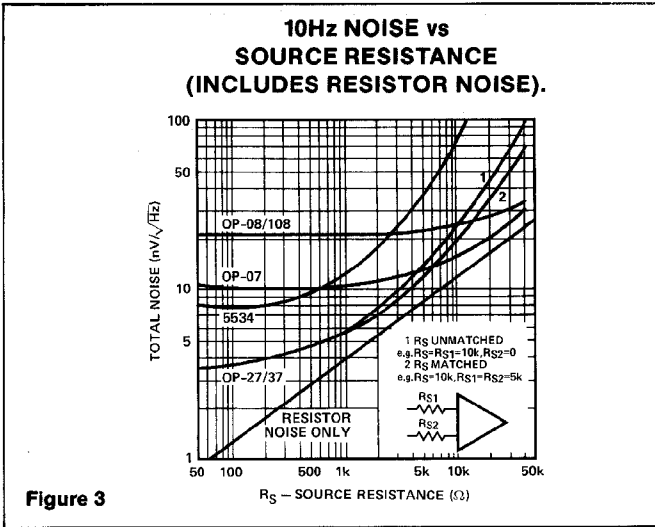
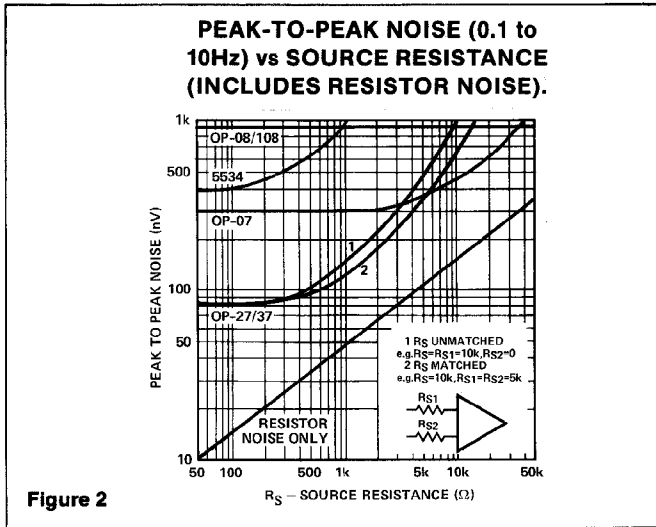

Figure 1

At $R_S < 1\text{k}\Omega$, the OP-27's low voltage noise is maintained. With $R_S > 1\text{k}\Omega$, total noise increases, but is dominated by the resistor noise rather than current or voltage noise. It is only beyond R_S of $20\text{k}\Omega$ that current noise starts to dominate. The argument can be made that current noise is not important for applications with low-to-moderate source resistances. The crossover between the OP-27 and OP-07 and OP-08 noise occurs in the 15 -to- $40\text{k}\Omega$ region.

Figure 2 shows the 0.1Hz -to- 10Hz peak-to-peak noise. Here the picture is less favorable; resistor noise is negligible, current noise becomes important because it is inversely proportional to the square-root of frequency. The crossover with the OP-07 occurs in the 3 -to- $5\text{k}\Omega$ range depending on whether balanced or unbalanced source resistors are used (at $3\text{k}\Omega$ the I_B , I_{OS} error also can be three times the V_{OS} spec.).

OP-27



Therefore, for low-frequency applications, the OP-07 is better than the OP-27/37 when $R_S > 3k\Omega$. The only exception is when gain error is important. Figure 3 illustrates the 10Hz noise. As expected, the results are between the previous two figures.

For reference, typical source resistances of some signal sources are listed in Table 1.

Table 1

DEVICE	SOURCE IMPEDANCE	COMMENTS
Strain gauge	<500Ω	Typically used in low-frequency applications.
Magnetic tapehead	<1500Ω	Low I_B very important to reduce self-magnetization problems when direct coupling is used. OP-27 I_B can be neglected.
Magnetic phonograph cartridges	<1500Ω	Similar need for low I_B in direct coupled applications. OP-27 will not introduce any self-magnetization problem.
Linear variable differential transformer	<1500Ω	Used in rugged servo-feedback applications. Bandwidth of interest is 400Hz to 5kHz.

OPEN-LOOP GAIN

FREQUENCY AT:	OP-07	OP-27	OP-37
3Hz	100dB	124dB	125dB
10Hz	100dB	120dB	125dB
30Hz	90dB	110dB	124dB

For further information regarding noise calculations, see "Minimization of Noise in Op-Amp Applications," Application Note AN-15.

AUDIO APPLICATIONS

The following applications information has been abstracted from a PMI article in the 12/20/80 issue of Electronic Design magazine and updated.

Figure 4 is an example of a phono pre-amplifier circuit using the OP-27 for A_1 ; R_1 - R_2 - C_1 - C_2 form a very accurate RIAA network with standard component values. The popular method to accomplish RIAA phono equalization is to employ frequency-dependent feedback around a high-quality gain block. Properly chosen, an RC network can provide the three necessary time constants of 3180, 318, and 75μs.¹

For initial equalization accuracy and stability, precision metal-film resistors and film capacitors of polystyrene or polypropylene are recommended since they have low voltage coefficients, dissipation factors, and dielectric absorption.⁴ (High-K ceramic capacitors should be avoided here, though low-K ceramics—such as NPO types, which have excellent dissipation factors, and somewhat lower dielectric absorption—can be considered for small values.)

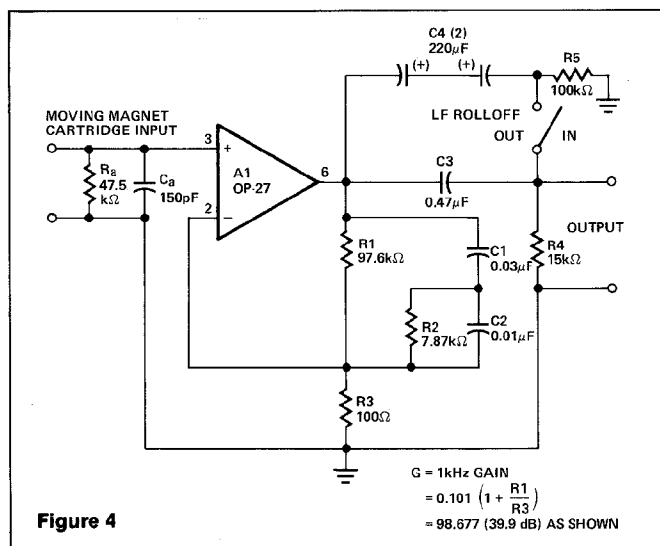

The OP-27 brings a $3.2\text{nV}/\sqrt{\text{Hz}}$ voltage noise and $0.45\text{ pA}/\sqrt{\text{Hz}}$ current noise to this circuit. To minimize noise from other sources, R_3 is set to a value of 100Ω , which generates a voltage noise of $1.3\text{nV}/\sqrt{\text{Hz}}$. The noise increases the $3.2\text{nV}/\sqrt{\text{Hz}}$ of the amplifier by only 0.7dB . With a $1\text{k}\Omega$ source, the circuit noise measures 63dB below a 1mV reference level, unweighted, in a 20kHz noise bandwidth.

Gain (G) of the circuit at 1kHz can be calculated by the expression:

$$G = 0.101 \left(1 + \frac{R_1}{R_3} \right)$$

For the values shown, the gain is just under 100 (or 40dB). Lower gains can be accommodated by increasing R_3 , but gains higher than 40dB will show more equalization errors because of the 8MHz gain-bandwidth of the OP-27.

This circuit is capable of very low distortion over its entire range, generally below 0.01% at levels up to 7V rms . At 3V output levels, it will produce less than 0.03% total harmonic distortion at frequencies up to 20kHz .

Capacitor C_3 and resistor R_4 form a simple -6dB-per-octave rumble filter, with a corner at 22Hz . As an option, the switch-selected shunt capacitor C_4 , a nonpolarized electrolytic, bypasses the low-frequency rolloff. Placing the rumble filter's high-pass action after the preamp has the desirable result of discriminating against the RIAA-amplified low-frequency noise components and pickup-produced low-frequency disturbances.

A preamplifier for NAB tape playback is similar to an RIAA phono preamp, though more gain is typically demanded, along with equalization requiring a heavy low-frequency boost. The circuit in Fig. 4 can be readily modified for tape use, as shown by Fig. 5.

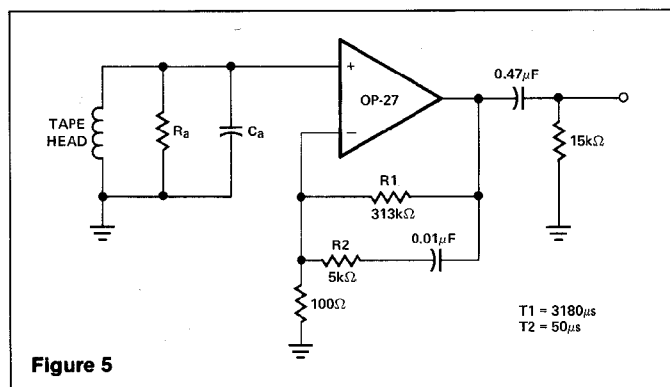

While the tape-equalization requirement has a flat high-frequency gain above 3kHz ($T_2 = 50\mu\text{s}$), the amplifier need not be stabilized for unity gain. The decompensated OP-37 provides a greater bandwidth and slew rate. For many applications, the idealized time constants shown may require trimming of R_1 and R_2 to optimize frequency response for nonideal tape-head performance and other factors.⁵

The network values of the configuration yield a 50dB gain at 1kHz , and the dc gain is greater than 70dB . Thus, the worst-case output offset is just over 500mV . A single $0.47\mu\text{F}$ output capacitor can block this level without affecting the dynamic range.

The tape head can be coupled directly to the amplifier input, since the worst-case bias current of 80nA with a 400mH , $100\mu\text{in.}$ head (such as the PRB2H7K) will not be troublesome.

One potential tape-head problem is presented by amplifier bias-current transients which can magnetize a head. The OP-27 and OP-37 are free of bias-current transients upon power up or power down. However, it is always advantageous to control the speed of power supply rise and fall, to eliminate transients.

In addition, the dc resistance of the head should be carefully controlled, and preferably below $1\text{k}\Omega$. For this configuration, the bias-current-induced offset voltage can be greater than the $100\mu\text{V}$ maximum offset if the head resistance is not sufficiently controlled.

A simple, but effective, fixed-gain transformerless microphone preamp (Fig. 6) amplifies differential signals from low-impedance microphones by 50dB , and has an input impedance of $2\text{k}\Omega$. Because of the high working gain of the circuit, an OP-37 helps to preserve bandwidth, which will be 110kHz . As the OP-37 is a decompensated device (minimum stable gain of 5), a dummy resistor, R_p , may be necessary, if the microphone is to be unplugged. Otherwise the 100% feedback from the open input may cause the amplifier to oscillate.

Common-mode input-noise rejection will depend upon the match of the bridge-resistor ratios. Either close-tolerance (0.1%) types should be used, or R_4 should be trimmed for best CMRR. All resistors should be metal-film types for best stability and low noise.

Noise performance of this circuit is limited more by the input resistors R_1 and R_2 than by the op amp, as R_1 and R_2 each generate a $4\text{nV}/\sqrt{\text{Hz}}$ noise, while the op amp generates a $3.2\text{nV}/\sqrt{\text{Hz}}$ noise. The rms sum of these predominant noise sources will be about $6\text{nV}/\sqrt{\text{Hz}}$, equivalent to $0.9\mu\text{V}$ in a 20kHz noise bandwidth, or nearly 61dB below a 1mV input signal. Measurements confirm this predicted performance.

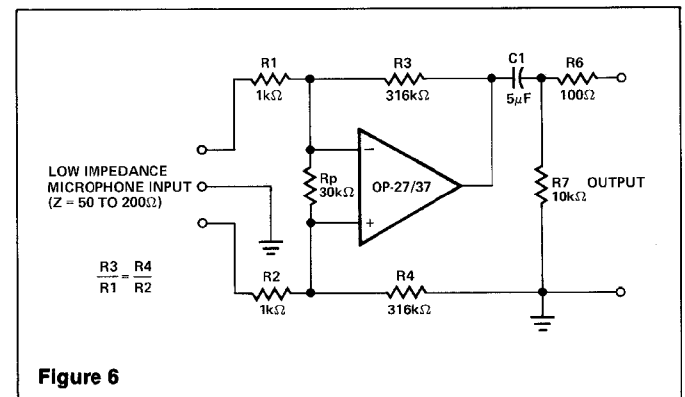

OP-27

For applications demanding appreciably lower noise, a high-quality microphone-transformer-coupled preamp (Fig. 7) incorporates the internally-compensated OP-27. T₁ is a JE-115K-E 150Ω/15kΩ transformer which provides an optimum source resistance for the OP-27 device. The circuit has an overall gain of 40dB, the product of the transformer's voltage setup and the op amp's voltage gain.

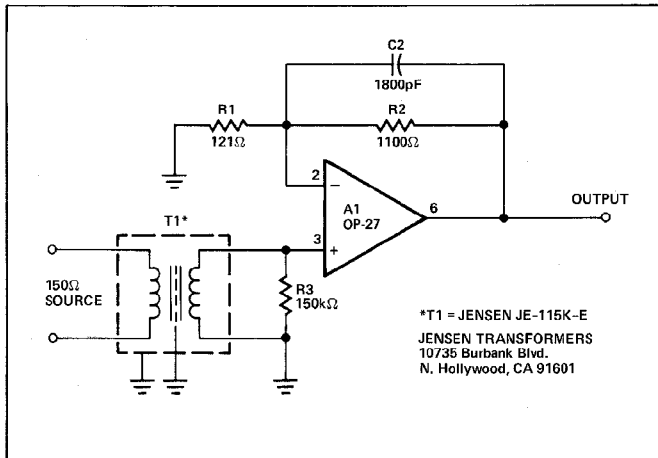

Gain may be trimmed to other levels, if desired, by adjusting R₂ or R₁. Because of the low offset voltage of the OP-27, the output offset of this circuit will be very low, 1.7mV or less, for a 40dB gain. The typical output blocking capacitor can be

eliminated in such cases, but is desirable for higher gains to eliminate switching transients.

Capacitor C₂ and resistor R₂ form a 2μs time constant in this circuit, as recommended for optimum transient response by the transformer manufacturer. With C₂ in use, A₁ must have unity-gain stability. For situations where the 2μs time constant is not necessary, C₂ can be deleted, allowing the faster OP-37 to be employed.

Some comment on noise is appropriate to understand the capability of this circuit. A 150Ω resistor and R₁ and R₂ gain resistors connected to a noiseless amplifier will generate 220 nV of noise in a 20kHz bandwidth, or 73dB below a 1mV reference level. Any practical amplifier can only approach this noise level; it can never exceed it. With the OP-27 and T₁ specified, the additional noise degradation will be close to 3.6dB (or -69.5 referenced to 1mV).

References

1. Lipshitz, S.P., "On RIAA Equalization Networks," *JAES*, Vol. 27, June 1979, p. 458-481.
2. Jung, W.G., *IC Op Amp Cookbook*, 2nd Ed., H.W. Sams and Company, 1980.
3. Jung, W.G., *Audio IC Op Amp Applications*, 2nd Ed., H.W. Sams and Company, 1978.
4. Jung, W.G., and Marsh, R.M., "Picking Capacitors," *Audio*, February & March, 1980.
5. Otala, M., "Feedback-Generated Phase Nonlinearity in Audio Amplifiers," London AES Convention, March 1980, preprint 1976.
6. Stout, D.F., and Kaufman, M., *Handbook of Operational Amplifier Circuit Design*, New York, McGraw Hill, 1976.

BURN-IN CIRCUIT

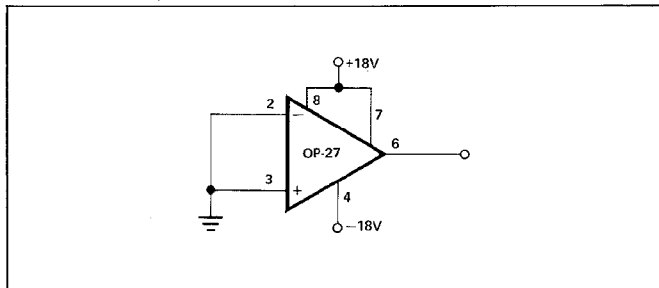

OFFSET NULLING CIRCUIT

