



Precision Micropower Single Supply Operational Amplifier

OP777

FEATURES

Low Offset Voltage: 100 μ V Max
Low Input Bias Current: 10 nA Max
Single-Supply Operation: 2.7 V to 30 V
Dual-Supply Operation: ± 1.35 V to ± 15 V
Low Supply Current: 270 μ A/Amp
Unity Gain Stable
No Phase Reversal

APPLICATIONS

Precision Current Measurement
Line or Battery-Powered Instrumentation
Remote Sensors
Precision Filters

GENERAL DESCRIPTION

The OP777 is a precision single supply amplifier featuring micropower operation and rail-to-rail output ranges. This amplifier provides improved performance over the industry-standard OP07 with ± 15 V supplies and offers the further advantage of true single supply operation down to 2.7 V, and smaller package footprint than any other high-voltage precision bipolar amplifier. Outputs are stable with capacitive loads of over 1000 pF. Supply current is less than 300 μ A per amplifier at 5 V. 500 Ω series resistors protect the inputs, allowing input signal levels to exceed either power supply rail by up to 3 V without causing phase reversal of the output signal or causing damage to the amplifier. The proprietary fabrication process yields a very low-voltage noise corner frequency under 10 Hz, greatly improving the low-frequency noise performance of the OP07 and similar amplifiers. The specially fabricated input PNP transistors operate with very low input bias currents while allowing operation with large differential voltages, eliminating a common limitation of many precision amplifiers and enabling application of the OP777 in precision comparator and rectifier circuits. This large differential voltage capability also further reduces the need for external protection devices such as clamping diodes.

REV. 0

Information furnished by Analog Devices is believed to be accurate and reliable. However, no responsibility is assumed by Analog Devices for its use, nor for any infringements of patents or other rights of third parties which may result from its use. No license is granted by implication or otherwise under any patent or patent rights of Analog Devices.

FUNCTIONAL BLOCK DIAGRAMS

8-Lead MSOP (RM Suffix)

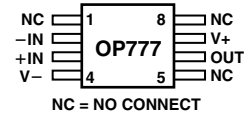

8-Lead SOIC (R Suffix)

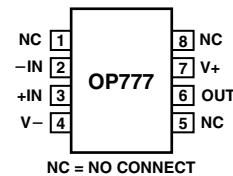

Applications for these amplifiers include both line powered and portable instrumentation, remote sensor signal conditioning, and precision filters.

The OP777 is specified over the extended industrial (-40°C to $+85^{\circ}\text{C}$) temperature range and is available in 8-lead MSOP and 8-lead SOIC packages. The OP777 uses a standard operational amplifier pinout, allowing for easy drop-in replacement of lower performance amplifiers in most circuits. Surface mount devices in MSOP packages are available in tape and reel only.

OP777—SPECIFICATIONS

ELECTRICAL CHARACTERISTICS ($V_S = 5.0\text{ V}$, $V_{CM} = 2.5\text{ V}$, $T_A = 25^\circ\text{C}$ unless otherwise noted)

Parameter	Symbol	Conditions	Min	Typ	Max	Unit
INPUT CHARACTERISTICS						
Offset Voltage	V_{OS}	$-40^\circ\text{C} \leq T_A \leq +85^\circ\text{C}$			100	μV
Input Bias Current	I_B	$-40^\circ\text{C} \leq T_A \leq +85^\circ\text{C}$			200	μV
Input Offset Current	I_{OS}	$-40^\circ\text{C} \leq T_A \leq +85^\circ\text{C}$			11	nA
Input Voltage Range			0		4	V
Common-Mode Rejection Ratio	CMRR	$V_{CM} = 0\text{ V to }4\text{ V}$	104	110		dB
Large Signal Voltage Gain	A_{VO}	$R_L = 10\text{ k}\Omega$, $V_O = 0.5\text{ V to }4.5\text{ V}$	300	500		V/mV
Offset Voltage Drift	$\Delta V_{OS}/\Delta T$	$-40^\circ\text{C} \leq T_A \leq +85^\circ\text{C}$		0.3	1.3	$\mu\text{V}/^\circ\text{C}$
OUTPUT CHARACTERISTICS						
Output Voltage High	V_{OH}	$I_L = 1\text{ mA}$, $-40^\circ\text{C} \leq T_A \leq +85^\circ\text{C}$	4.88			V
Output Voltage Low	V_{OL}	$I_L = 1\text{ mA}$, $-40^\circ\text{C} \leq T_A \leq +85^\circ\text{C}$			140	mV
Short Circuit Limit	I_{OUT}	$V_{DROPOUT} < 1\text{ V}$		± 10		mA
POWER SUPPLY						
Power Supply Rejection Ratio	PSRR	$V_S = 3\text{ V to }30\text{ V}$	120	130		dB
Supply Current/Amplifier	I_{SY}	$V_O = 0\text{ V}$ $-40^\circ\text{C} \leq T_A \leq +85^\circ\text{C}$			270	μA
					270	μA
DYNAMIC PERFORMANCE						
Slew Rate	SR	$R_L = 2\text{ k}\Omega$		0.2		V/ μs
Gain Bandwidth Product	GBP			0.7		MHz
NOISE PERFORMANCE						
Voltage Noise	$e_n\text{p-p}$	0.1 Hz to 10 Hz		0.4		$\mu\text{Vp-p}$
Voltage Noise Density	e_n	$f = 1\text{ kHz}$		15		$\text{nV}/\sqrt{\text{Hz}}$
Current Noise Density	i_n	$f = 1\text{ kHz}$		0.13		$\text{pA}/\sqrt{\text{Hz}}$

Specifications subject to change without notice.

ELECTRICAL CHARACTERISTICS ($V_S = \pm 15.0\text{ V}$, $V_{CM} = 0\text{ V}$, $T_A = 25^\circ\text{C}$ unless otherwise noted)

Parameter	Symbol	Conditions	Min	Typ	Max	Unit
INPUT CHARACTERISTICS						
Offset Voltage	V_{OS}	$-40^\circ\text{C} \leq T_A \leq +85^\circ\text{C}$			100	μV
Input Bias Current	I_B	$-40^\circ\text{C} \leq T_A \leq +85^\circ\text{C}$			200	μV
Input Offset Current	I_{OS}	$-40^\circ\text{C} \leq T_A \leq +85^\circ\text{C}$			10	nA
Input Voltage Range			-15		+14	V
Common-Mode Rejection Ratio	CMRR	$V_{CM} = -15\text{ V to } +14\text{ V}$	110	120		dB
Large Signal Voltage Gain	A_{VO}	$R_L = 10\text{ k}\Omega$, $V_O = -14.5\text{ V to } +14.5\text{ V}$	1,000	2,500		V/mV
Offset Voltage Drift	$\Delta V_{OS}/\Delta T$	$-40^\circ\text{C} \leq T_A \leq +85^\circ\text{C}$		0.3	1.3	$\mu\text{V}/^\circ\text{C}$
OUTPUT CHARACTERISTICS						
Output Voltage High	V_{OH}	$I_L = 1\text{ mA}$, $-40^\circ\text{C} \leq T_A \leq +85^\circ\text{C}$	14.9			V
Output Voltage Low	V_{OL}	$I_L = 1\text{ mA}$, $-40^\circ\text{C} \leq T_A \leq +85^\circ\text{C}$			-14.9	V
Short Circuit Limit	I_{OUT}			± 30		mA
POWER SUPPLY						
Power Supply Rejection Ratio	PSRR	$V_S = \pm 1.5\text{ V to } \pm 15\text{ V}$	120	130		dB
Supply Current/Amplifier	I_{SY}	$V_O = 0\text{ V}$ $-40^\circ\text{C} \leq T_A \leq +85^\circ\text{C}$			350	μA
					400	μA
DYNAMIC PERFORMANCE						
Slew Rate	SR	$R_L = 2\text{ k}\Omega$		0.2		V/ μs
Gain Bandwidth Product	GBP			0.7		MHz
NOISE PERFORMANCE						
Voltage Noise	$e_{n\text{p-p}}$	0.1 Hz to 10 Hz		0.4		$\mu\text{Vp-p}$
Voltage Noise Density	e_n	$f = 1\text{ kHz}$		15		$\text{nV}/\sqrt{\text{Hz}}$
Current Noise Density	i_n	$f = 1\text{ kHz}$		0.13		$\text{pA}/\sqrt{\text{Hz}}$

Specifications subject to change without notice.

OP777

ABSOLUTE MAXIMUM RATINGS*

Supply Voltage	36 V
Input Voltage	$V_{S-} - 3 \text{ V}$ to $V_{S+} + 3 \text{ V}$
Differential Input Voltage	\pm Supply Voltage
Output Short-Circuit Duration to GND	Indefinite
Storage Temperature Range	
R, RM Packages	-65°C to $+150^{\circ}\text{C}$
Operating Temperature Range	
OP777	-40°C to $+85^{\circ}\text{C}$
Junction Temperature Range	
R, RM Packages	-65°C to $+150^{\circ}\text{C}$
Lead Temperature Range (Soldering, 60 sec)	300°C
ESD (HBM)	2 kV

*Stresses above those listed under Absolute Maximum Ratings may cause permanent damage to the device. This is a stress rating only; functional operation of the device at these or any other conditions above those listed in the operational sections of this specification is not implied. Exposure to absolute maximum rating conditions for extended periods may affect device reliability.

Package Type	θ_{JA}^1	θ_{JC}	Unit
8-Lead MSOP (RM)	190	44	$^{\circ}\text{C}/\text{W}$
8-Lead SOIC (R)	158	43	$^{\circ}\text{C}/\text{W}$

NOTE

¹ θ_{JA} is specified for worst-case conditions, i.e., θ_{JA} is specified for device soldered in circuit board for surface-mount packages.

ORDERING GUIDE

Model	Temperature Range	Package Description	Package Option	Branding Information
OP777ARM	-40°C to $+85^{\circ}\text{C}$	8-Lead MSOP	RM-8	A1A
OP777AR	-40°C to $+85^{\circ}\text{C}$	8-Lead SOIC	SO-8	

CAUTION

ESD (electrostatic discharge) sensitive device. Electrostatic charges as high as 4000 V readily accumulate on the human body and test equipment and can discharge without detection. Although the OP777 features proprietary ESD protection circuitry, permanent damage may occur on devices subjected to high-energy electrostatic discharges. Therefore, proper ESD precautions are recommended to avoid performance degradation or loss of functionality.



Typical Performance Characteristics—OP777

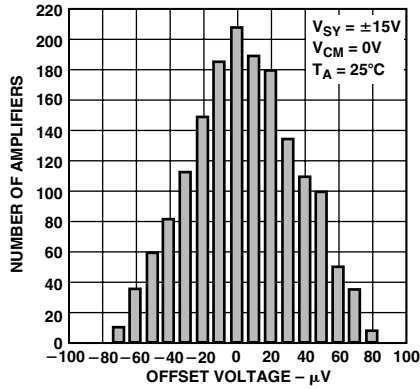

Figure 1. Input Offset Voltage Distribution

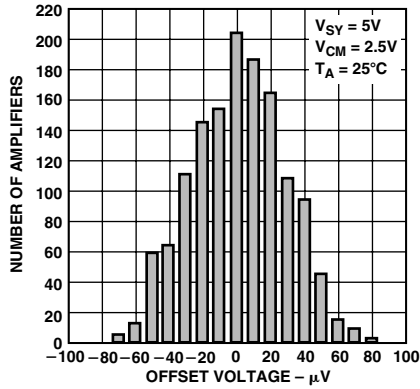

Figure 2. Input Offset Voltage Distribution

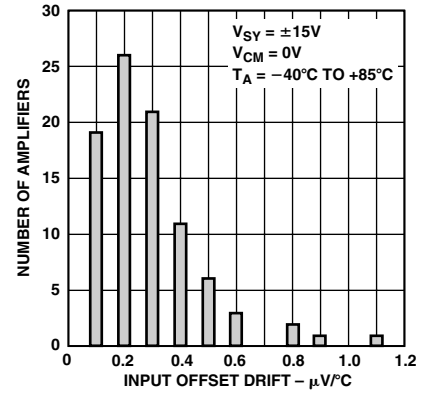

Figure 3. Input Offset Voltage Drift Distribution

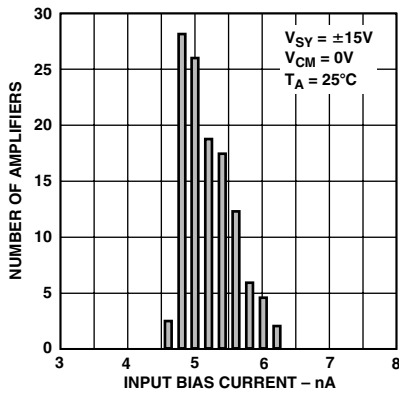

Figure 4. Input Bias Current Distribution

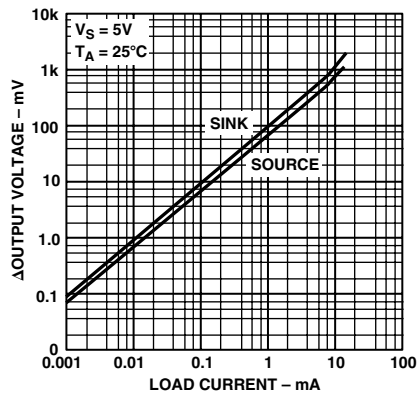

Figure 5. Output Voltage to Supply Rail vs. Load Current

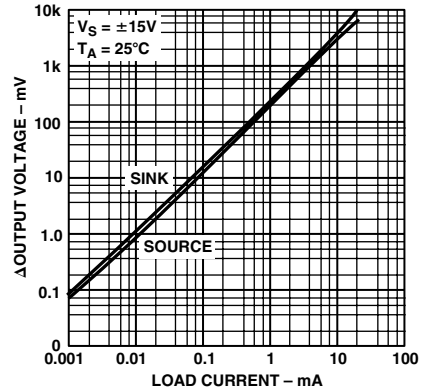

Figure 6. Output Voltage to Supply Rail vs. Load Current

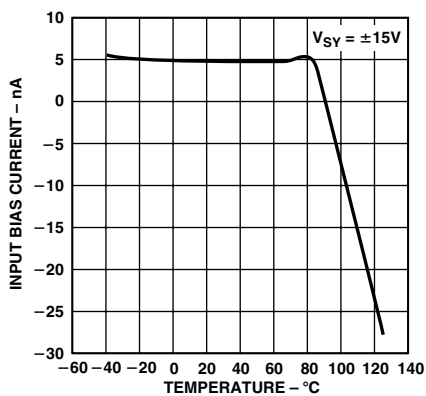

Figure 7. Input Bias Current vs. Temperature

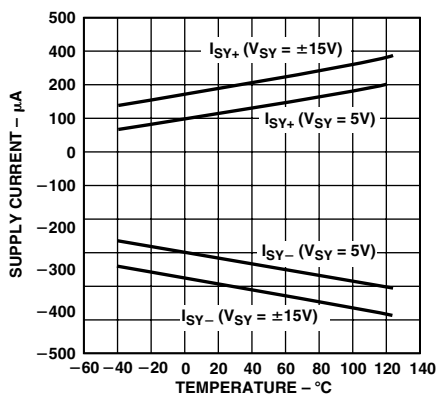

Figure 8. Supply Current vs. Temperature

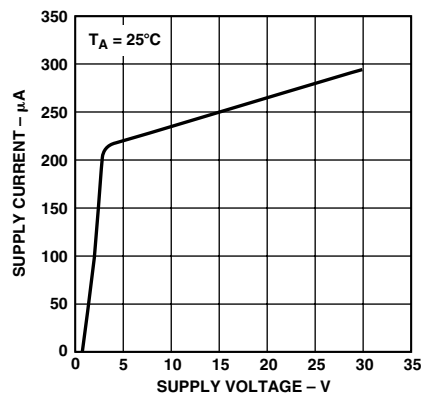

Figure 9. Supply Current vs. Supply Voltage

OP777

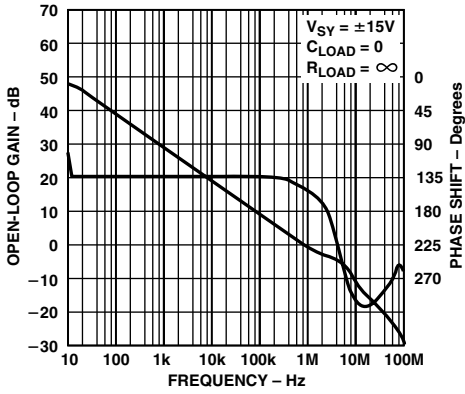

Figure 10. Open Loop Gain and Phase Shift vs. Frequency

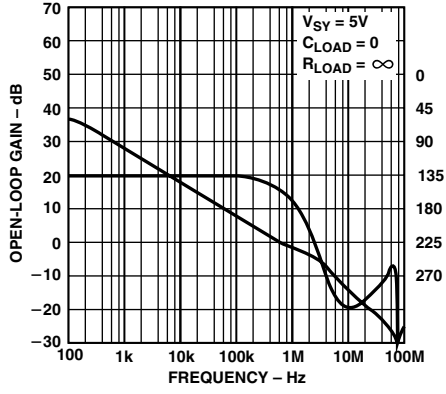

Figure 11. Open Loop Gain and Phase Shift vs. Frequency

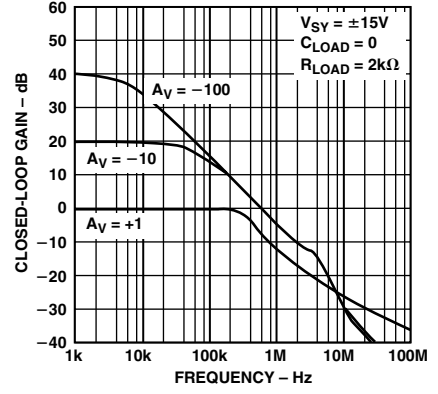

Figure 12. Closed Loop Gain vs. Frequency

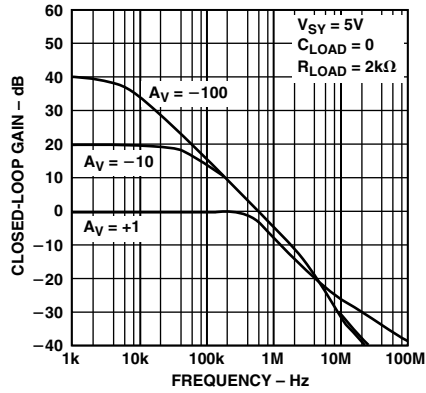

Figure 13. Closed Loop Gain vs. Frequency

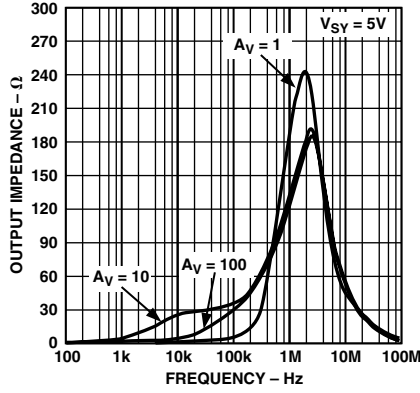

Figure 14. Output Impedance vs. Frequency

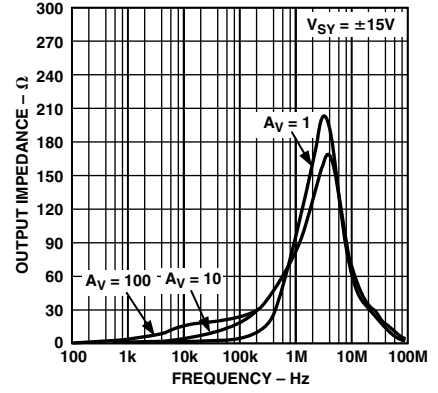

Figure 15. Output Impedance vs. Frequency

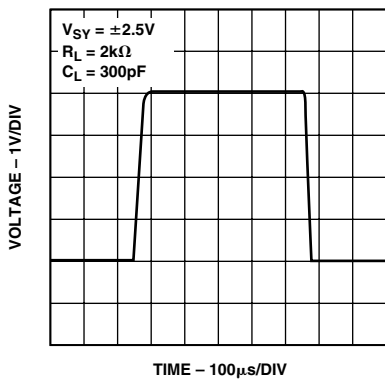

Figure 16. Large Signal Transient Response

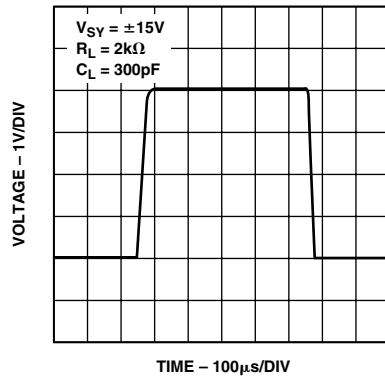

Figure 17. Large Signal Transient Response

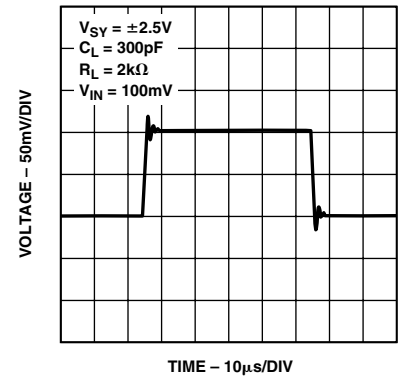

Figure 18. Small Signal Transient Response

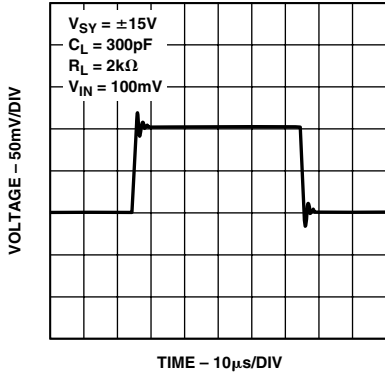

Figure 19. Small Signal Transient Response

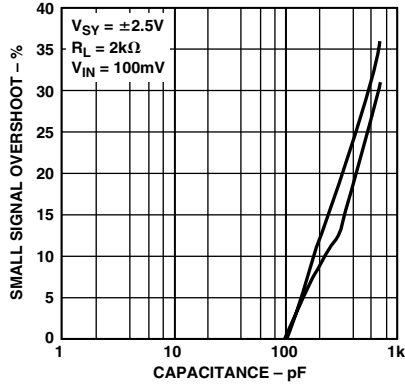

Figure 20. Small Signal Overshoot vs. Load Capacitance

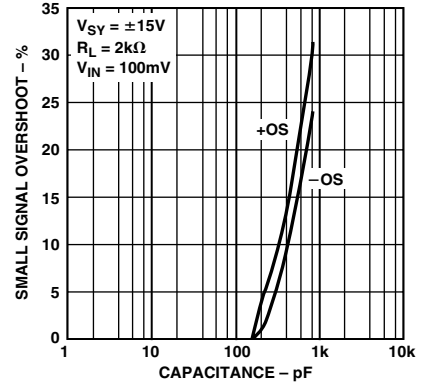

Figure 21. Small Signal Overshoot vs. Load Capacitance

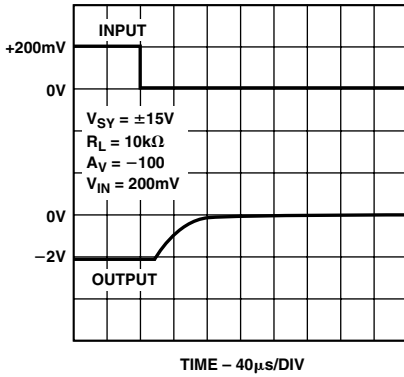

Figure 22. Positive Overtolerance Recovery

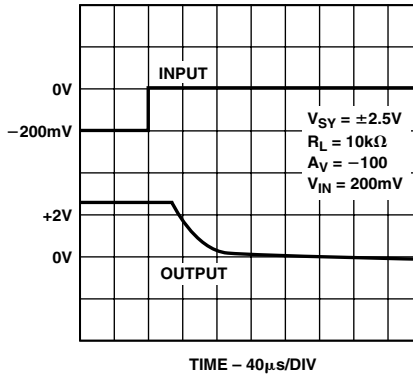

Figure 23. Negative Overtolerance Recovery

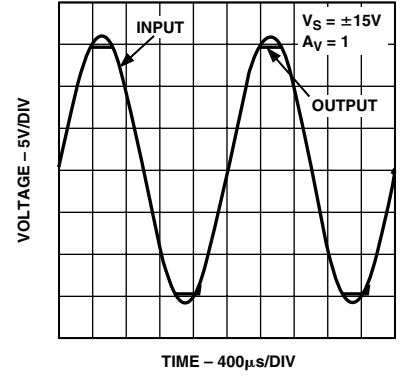

Figure 24. No Phase Reversal

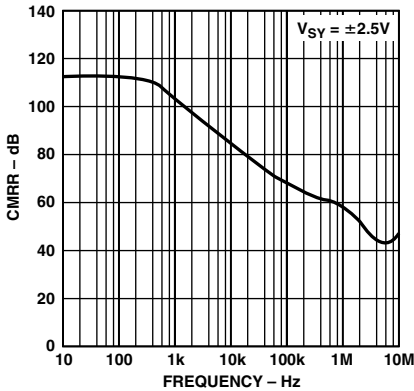

Figure 25. CMRR vs. Frequency

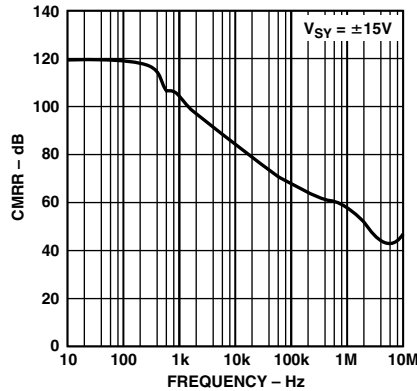

Figure 26. CMRR vs. Frequency

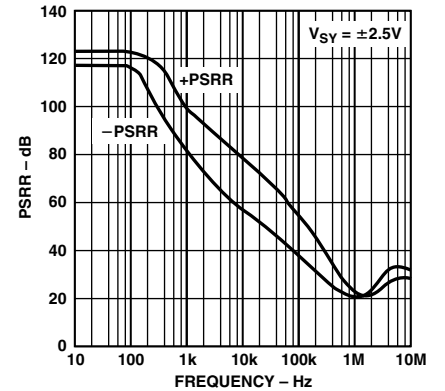

Figure 27. PSRR vs. Frequency

OP777

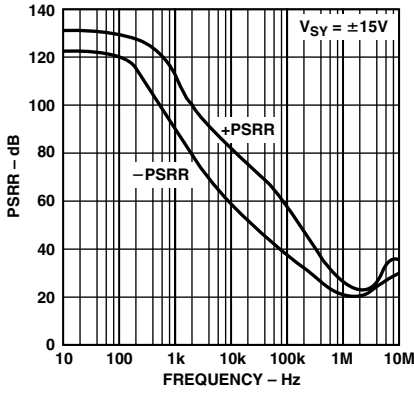

Figure 28. PSRR vs. Frequency

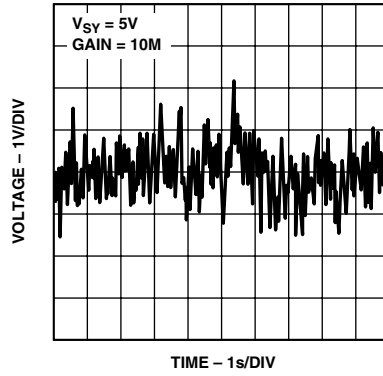

Figure 29. 0.1 Hz to 10 Hz Input Voltage Noise

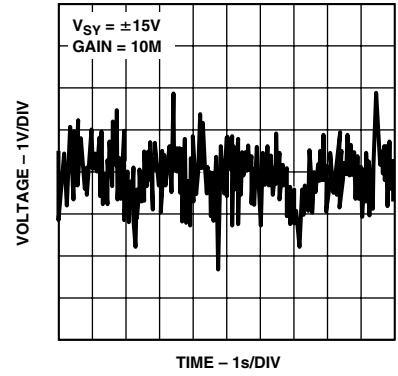

Figure 30. 0.1 Hz to 10 Hz Input Voltage Noise

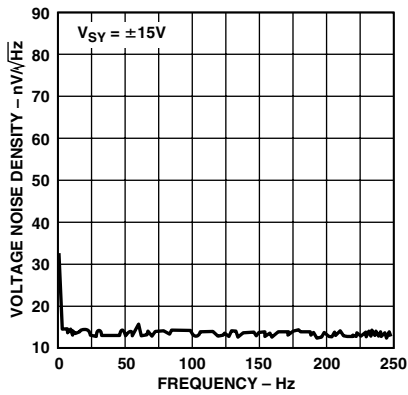

Figure 31. Voltage Noise Density

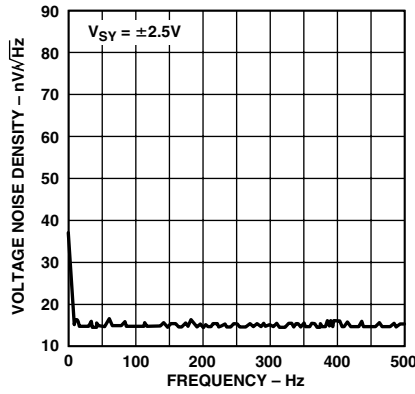

Figure 32. Voltage Noise Density

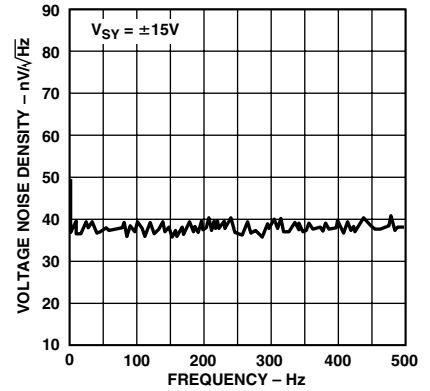

Figure 33. Voltage Noise Density

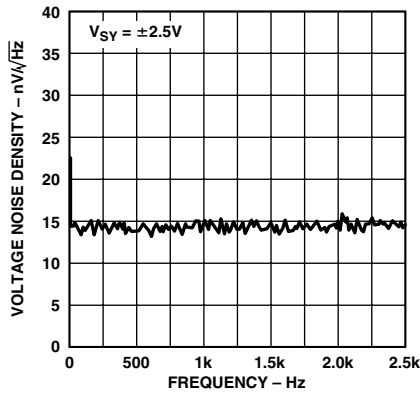

Figure 34. Voltage Noise Density

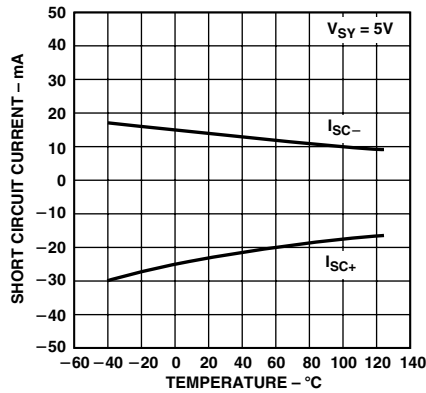

Figure 35. Short Circuit Current vs. Temperature

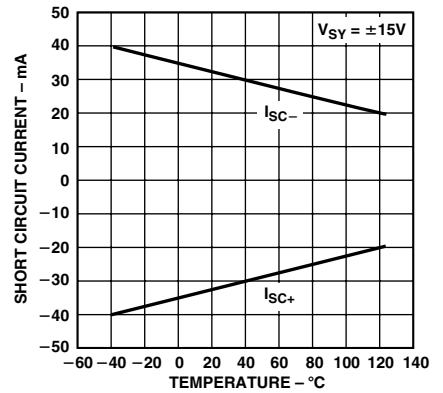

Figure 36. Short Circuit Current vs. Temperature

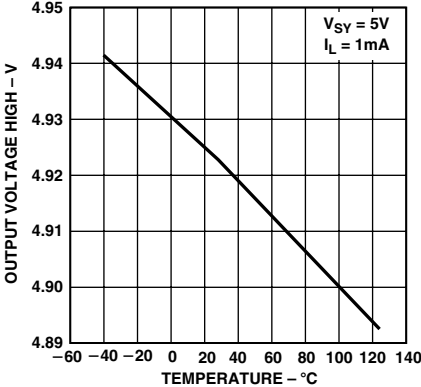

Figure 37. Output Voltage High vs. Temperature

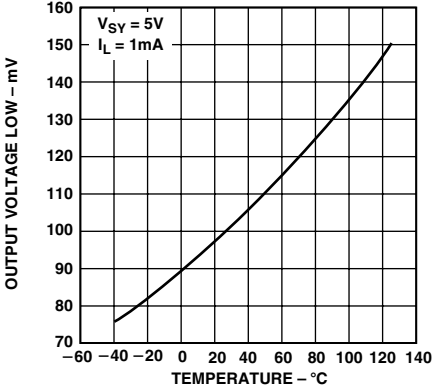

Figure 38. Output Voltage Low vs. Temperature

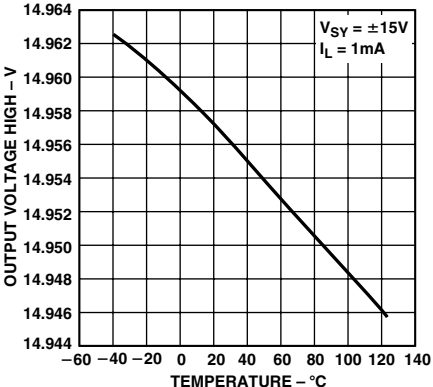

Figure 39. Output Voltage High vs. Temperature

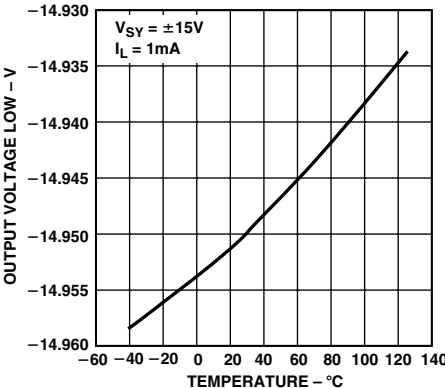

Figure 40. Output Voltage Low vs. Temperature

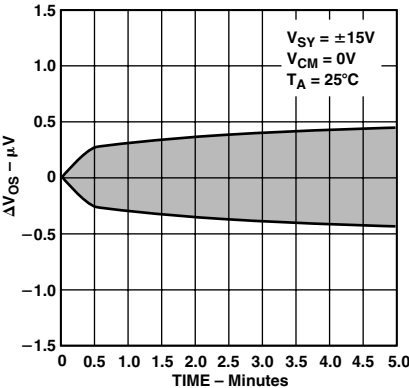

Figure 41. Warm-Up Drift

OP777

BASIC OPERATION

The OP777 amplifier uses a precision Bipolar PNP input stage coupled with a high-voltage CMOS output stage. This enables this amplifier to feature an input voltage range which includes the negative supply voltage (often ground-in single-supply applications) and also swing to within 1 mV of the output rails. Additionally, the input voltage range extends to within 1 V of the positive supply rail. The epitaxial PNP input structure provides high breakdown voltage, high gain, and input bias current figure comparable to that obtained with “Darlington” input stage amplifier but without the drawbacks (i.e., severe penalties for input voltage range, offset, drift and noise). PNP input structure also greatly lowers the noise and reduces the dc input error terms.

Supply Voltage

The amplifiers are fully specified with a single 5 V supply and, due to design and process innovations, can also operate with a supply voltage from 2.7 V up to 30 V. This allows operation from most split supplies used in current industry practice, with the advantage of substantially increased input and output voltage ranges over conventional split-supply amplifiers. The OP777 series is specified with ($V_{SY} = 5\text{ V}$, $V_- = 0\text{ V}$ and $V_{CM} = 2.5\text{ V}$ which is most suitable for single supply application. With PSRR of 130 dB ($0.3\text{ }\mu\text{V/V}$) and CMRR of 110 dB ($3\text{ }\mu\text{V/V}$) offset is minimally affected by power supply or common-mode voltages. Dual supply, $\pm 15\text{ V}$ operation is also fully specified.

Input Common-Mode Voltage Range

The OP777 is rated with an input common-mode voltage which extends from minus supply to 1 V of the Positive supply. However, the amplifier can still operate with input voltages slightly below V_{EE} . In Figure 43, OP777 is configured as a difference amplifier with a single supply of 2.7 V and negative dc common-mode voltages applied at the inputs terminals. A 400 mV p-p input is then applied to the noninverting input. It can be seen from the graph below that the output does not show any distortion. Micropower operation is maintained by using large input and feedback resistors.

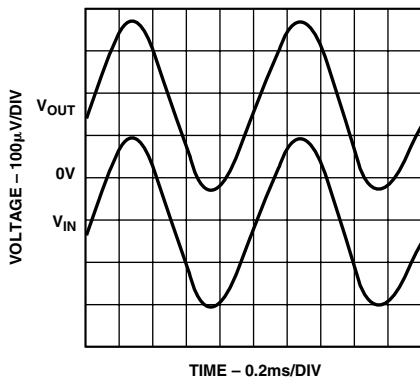

Figure 42. Input and Output Signals with $V_{CM} < 0\text{ V}$

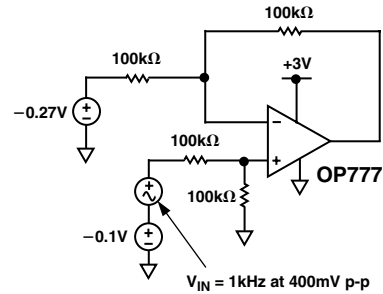

Figure 43. OP777 Configured as a Difference Amplifier Operating at $V_{CM} < 0\text{ V}$

Input Over Voltage Protection

When the input of an amplifier is more than a diode drop below V_{EE} , large currents will flow from the substrate (V_- pin) to the input pins which can destroy the device. In the case of OP777, differential voltage equal to the supply voltage will not cause any problem (see Figure 44). OP777 has built in $500\text{ }\Omega$ internal current limiting resistors, in series with the inputs, to minimize the chances of damage. It is a good practice to keep the current flowing into the inputs below 5 mA. In this context it should also be noted that the high breakdown of the input transistors removes the necessity for clamp diodes between the inputs of the amplifier; a feature that is mandatory on many precision op amps. Unfortunately, such clamp diodes greatly interfere with many application circuits such as precision rectifiers and comparators. The OP777 series is free from such limitations.

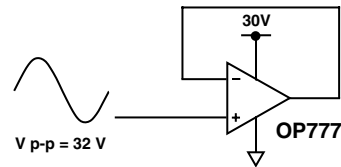

Figure 44a. Unity Gain Follower

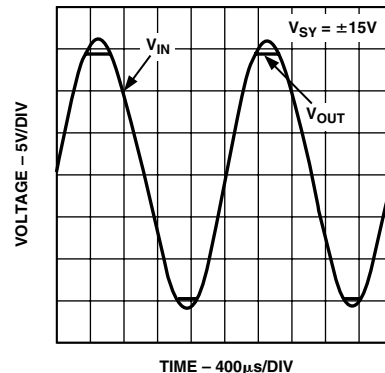

Figure 44b. Input Voltage Can Exceed the Supply Voltage Without Damage

Phase Reversal

Many amplifiers misbehave when one or both of the inputs are forced beyond the input common-mode voltage range. Phase reversal is typified by the transfer function of the amplifier, effectively reversing its transfer polarity. In some cases this can cause lockup in servo systems and may cause permanent damage or nonrecoverable parameter shifts to the amplifier. Many amplifiers feature compensation circuitry to combat these effects, but some are only effective for the inverting input. Additionally, many of these schemes only work for a few hundred millivolts or so beyond the supply rails. OP777 has a protection circuit against phase reversal when one or both inputs are forced beyond their input common voltage range. It is not recommended that the parts be continuously driven more than 3 V beyond the rails.

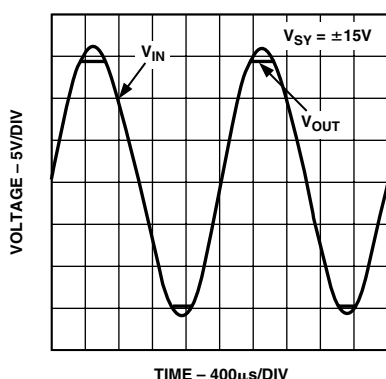

Figure 45. No Phase Reversal

Output Stage

The CMOS output stage has excellent (and fairly symmetric) output drive and with light loads can actually swing to within 1 mV of both supply rails. This is considerably better than similar amplifiers featuring (so-called) rail-to-rail bipolar output stages. OP777 is stable in the voltage follower configuration and responds to signals as low as 1 mV above ground in single supply operation.

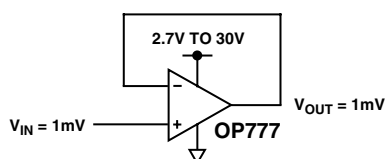

Figure 46. Follower Circuit

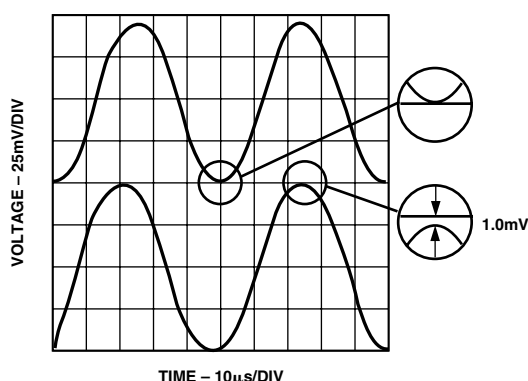

Figure 47. Rail-to-Rail Operation

Output Short Circuit

The output of the OP777 series amplifier is protected from damage against accidental shorts to either supply voltage, provided that the maximum die temperature is not exceeded on a long-term basis (see Absolute Maximum Rating section). Current of up to 30 mA does not cause any damage.

A Low-Side Current Monitor

In the design of power supply control circuits, a great deal of design effort is focused on ensuring a pass transistor's long-term reliability over a wide range of load current conditions. As a result, monitoring and limiting device power dissipation is of prime importance in these designs. Figure 48 shows an example of 5 V, single supply current monitor that can be incorporated into the design of a voltage regulator with foldback current limiting or a high current power supply with crowbar protection. The design capitalizes on the OP777's common-mode range that extends to ground. Current is monitored in the power supply return where a 0.1 Ω shunt resistor, R_{SENSE}, creates a very small voltage drop. The voltage at the inverting terminal becomes equal to the voltage at the noninverting terminal through the feedback of Q1, which is a 2N2222 or equivalent NPN transistor. This makes the voltage drop across R1 equal to the voltage drop across R_{SENSE}. Therefore, the current through Q1 becomes directly proportional to the current through R_{SENSE}, and the output voltage is given by:

$$V_{OUT} = 5V - \left(\frac{R2}{R1} \times R_{SENSE} \times I_L \right)$$

The voltage drop across R2 increases with I_L increasing, so V_{OUT} decreases with higher supply current being sensed. For the element values shown, the V_{OUT} transfer characteristic is -2.5 V/A, decreasing from V_{EE}.

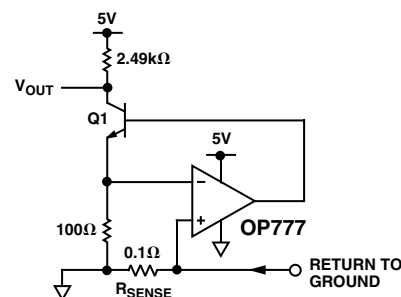

Figure 48. A Low-Side Load Current Monitor

OP777

The OP777 can be very useful in many single supply bridge applications. Figure 49 shows a single supply bridge circuit in which its output is linearly proportional to the fractional deviation (δ) of the bridge. Note that $\delta = \Delta R/R$.

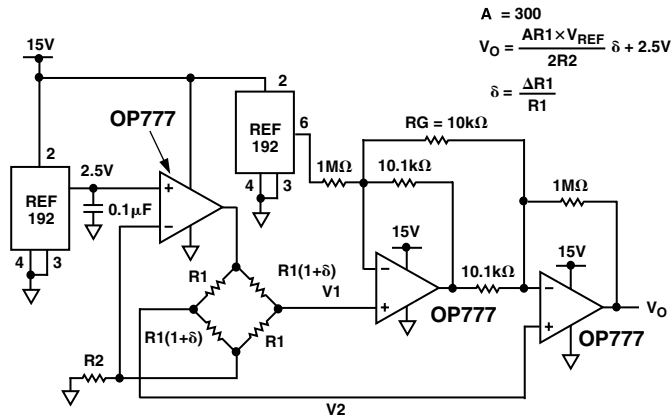

Figure 49. Linear Response Bridge, Single Supply

In systems, where dual supplies are available, circuit of Figure 50 could be used to detect bridge outputs that are linearly related to fractional deviation of the bridge.

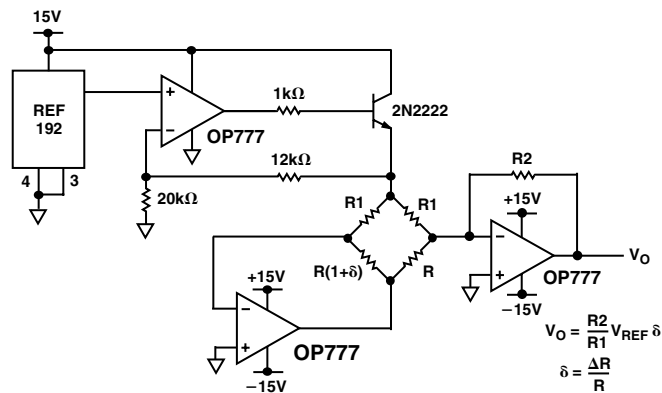

Figure 50. Linear Response Bridge

A single supply current source is shown in Figure 51. Large resistors are used to maintain micropower operation. Output current can be adjusted by changing the R2B resistor. Compliance voltage is:

$$|V_L| \leq |V_{SAT}| - |V_S|$$

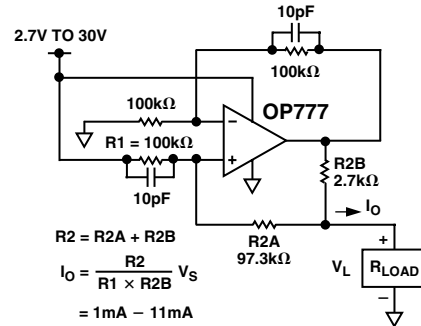

Figure 51. Single Supply Current Source

A single supply instrumentation amplifier using two OP777 amplifiers is shown in Figure 52.

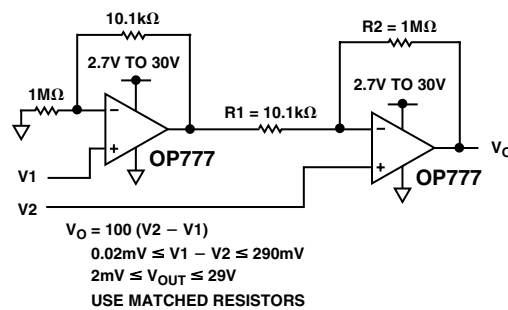
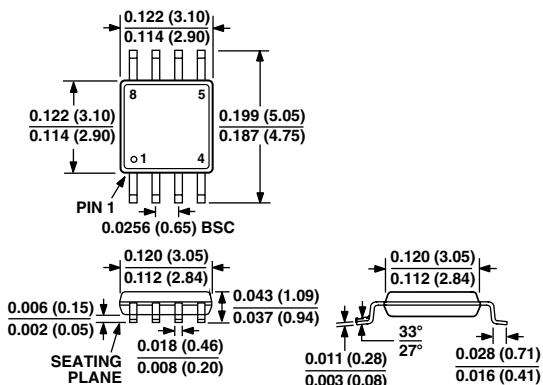

Figure 52. Single Supply Micropower Instrumentation Amplifier

OUTLINE DIMENSIONS

Dimensions shown in inches and (mm).

8-Lead μ SOIC (RM Suffix)



8-Lead SOIC (R Suffix)

