

FEATURES

- Modulated serial digital output, proportional to temperature**
- ±0.5°C accuracy at 25°C**
- ±1.0°C accuracy from 25°C to 70°C**
- Two grades available**
- Operation from -40°C to +150°C**
- Operation from 3 V to 5.5 V**
- Power consumption 70 µW maximum at 3.3 V**
- CMOS/TTL-compatible output on TMP05**
- Flexible open-drain output on TMP06**
- Small, low cost 5-lead SC-70 and SOT-23 packages**

APPLICATIONS

- Isolated sensors**
- Environmental control systems**
- Computer thermal monitoring**
- Thermal protection**
- Industrial process control**
- Power-system monitors**

GENERAL DESCRIPTION

The TMP05/TMP06 are monolithic temperature sensors that generate a modulated serial digital output (PWM), which varies in direct proportion to the temperature of the devices. The high period (T_H) of the PWM remains static over all temperatures, while the low period (T_L) varies. The B Grade version offers a higher temperature accuracy of ±1°C from 0°C to 70°C with excellent transducer linearity. The digital output of the TMP05/TMP06 is CMOS/TTL compatible, and is easily interfaced to the serial inputs of most popular microprocessors. The flexible open-drain output of the TMP06 is capable of sinking 5 mA.

The TMP05/TMP06 are specified for operation at supply voltages from 3 V to 5.5 V. Operating at 3.3 V, the supply current is typically 370 µA. The TMP05/TMP06 are rated for operation over the -40°C to +150°C temperature range. It is not recommended to operate these devices at temperatures above 125°C for more than a total of 5% (5,000 hours) of the lifetime of the devices. They are packaged in low cost, low area SC-70 and SOT-23 packages.

Rev. 0

Information furnished by Analog Devices is believed to be accurate and reliable. However, no responsibility is assumed by Analog Devices for its use, nor for any infringements of patents or other rights of third parties that may result from its use. Specifications subject to change without notice. No license is granted by implication or otherwise under any patent or patent rights of Analog Devices. Trademarks and registered trademarks are the property of their respective owners.

FUNCTIONAL BLOCK DIAGRAM

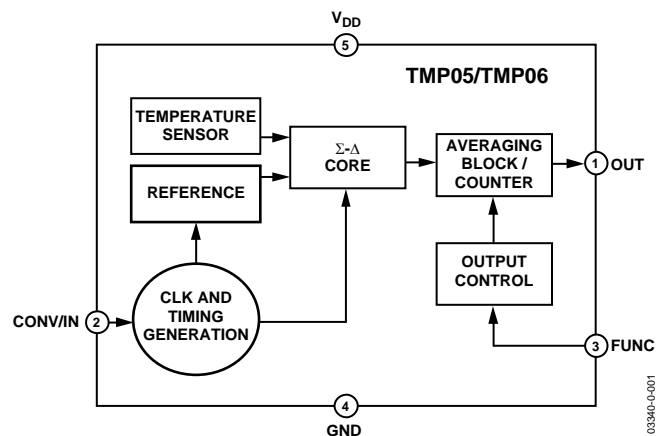

Figure 1.

The TMP05/TMP06 have three modes of operation: continuously converting mode, daisy-chain mode, and one shot mode. A three-state FUNC input determines the mode in which the TMP05/TMP06 operate.

The CONV/IN input pin is used to determine the rate with which the TMP05/TMP06 measure temperature in continuously converting mode and one shot mode. In daisy-chain mode, the CONV/IN pin operates as the input to the daisy chain.

PRODUCT HIGHLIGHTS

1. The TMP05/TMP06 have an on-chip temperature sensor that allows an accurate measurement of the ambient temperature. The measurable temperature range is -40°C to +150°C.
2. Supply voltage is 3.0 V to 5.5 V.
3. Space-saving 5-lead SOT-23 and SC-70 packages.
4. Temperature accuracy is typically ±0.5°C. The part needs a decoupling capacitor to achieve this accuracy.
5. 0.025°C temperature resolution.
6. The TMP05/TMP06 feature a one shot mode that reduces the average power consumption to 102 µW at 1 SPS.

TMP05/TMP06

TABLE OF CONTENTS

Specifications.....	3	Operating Modes.....	13
TMP05A/TMP06A Specifications	3	TMP05 Output	16
TMP05B/TMP06B Specifications	5	TMP06 Output	16
Timing Characteristics	7	Application Hints	17
Absolute Maximum Ratings.....	8	Thermal Response Time	17
ESD Caution.....	8	Self-Heating Effects.....	17
Pin Configuration and Function Descriptions.....	9	Supply Decoupling	17
Typical Performance Characteristics	10	Temperature Monitoring.....	18
Theory of Operation	13	Daisy-Chain Application.....	18
Circuit Information.....	13	Continuously Converting Application	23
Converter Details.....	13	Outline Dimensions	25
Functional Description.....	13	Ordering Guide	25

REVISION HISTORY

8/04—Revision 0: Initial Version

SPECIFICATIONS

TMP05A/TMP06A SPECIFICATIONS

All A Grade specifications apply for -40°C to $+150^{\circ}\text{C}$; V_{DD} decoupling capacitor is a 0.1 μF multilayer ceramic; $T_{\text{A}} = T_{\text{MIN}}$ to T_{MAX} , $V_{\text{DD}} = 3.0\text{ V}$ to 5.5 V , unless otherwise noted.

Table 1.

Parameter	Min	Typ	Max	Unit	Test Conditions/Comments
TEMPERATURE SENSOR AND ADC					
Nominal Conversion Rate (One Shot Mode)					See Table 7
Accuracy @ $V_{\text{DD}} = 3.3\text{ V}$ ($3.0\text{ V} - 3.6\text{ V}$)			± 2	$^{\circ}\text{C}$	$T_{\text{A}} = 0^{\circ}\text{C}$ to 70°C , $V_{\text{DD}} = 3.0\text{ V} - 3.6\text{ V}$
			± 3	$^{\circ}\text{C}$	$T_{\text{A}} = -40^{\circ}\text{C}$ to $+70^{\circ}\text{C}$, $V_{\text{DD}} = 3.0\text{ V} - 3.6\text{ V}$
			± 4	$^{\circ}\text{C}$	$T_{\text{A}} = -40^{\circ}\text{C}$ to $+125^{\circ}\text{C}$, $V_{\text{DD}} = 3.0\text{ V} - 3.6\text{ V}$
			$\pm 5^1$	$^{\circ}\text{C}$	$T_{\text{A}} = -40^{\circ}\text{C}$ to $+150^{\circ}\text{C}$, $V_{\text{DD}} = 3.0\text{ V} - 3.6\text{ V}$
Accuracy @ $V_{\text{DD}} = 5\text{ V}$ ($4.5\text{ V} - 5.5\text{ V}$)		1.5		$^{\circ}\text{C}$	$T_{\text{A}} = 0^{\circ}\text{C}$ to 125°C , $V_{\text{DD}} = 4.5\text{ V} - 5.5\text{ V}$
Temperature Resolution		0.025		$^{\circ}\text{C}/5\ \mu\text{s}$	Step size for every $5\ \mu\text{s}$ on T_{L}
T_{H} Pulse Width		40		ms	$T_{\text{A}} = 25^{\circ}\text{C}$, nominal conversion rate
T_{L} Pulse Width		76		ms	$T_{\text{A}} = 25^{\circ}\text{C}$, nominal conversion rate
Quarter Period Conversion Rate (All Operating Modes)					See Table 7
Accuracy @ $V_{\text{DD}} = 3.3\text{ V}$ ($3.0\text{ V} - 3.6\text{ V}$)		1.5		$^{\circ}\text{C}$	$T_{\text{A}} = -40^{\circ}\text{C}$ to $+150^{\circ}\text{C}$
Accuracy @ $V_{\text{DD}} = 5\text{ V}$ ($4.5\text{ V} - 5.5\text{ V}$)		1.5		$^{\circ}\text{C}$	$T_{\text{A}} = 0^{\circ}\text{C}$ to 125°C
Temperature Resolution		0.1		$^{\circ}\text{C}/5\ \mu\text{s}$	Step size for every $5\ \mu\text{s}$ on T_{L}
T_{H} Pulse Width		10		ms	$T_{\text{A}} = 25^{\circ}\text{C}$, QP conversion rate
T_{L} Pulse Width		19		ms	$T_{\text{A}} = 25^{\circ}\text{C}$, QP conversion rate
Double High/Quarter Low Conversion Rate (All Operating Modes)					See Table 7
Accuracy @ $V_{\text{DD}} = 3.3\text{ V}$ ($3.0\text{ V} - 3.6\text{ V}$)		1.5		$^{\circ}\text{C}$	$T_{\text{A}} = -40^{\circ}\text{C}$ to $+150^{\circ}\text{C}$
Accuracy @ $V_{\text{DD}} = 5\text{ V}$ ($4.5\text{ V} - 5.5\text{ V}$)		1.5		$^{\circ}\text{C}$	$T_{\text{A}} = 0^{\circ}\text{C}$ to 125°C
Temperature Resolution		0.1		$^{\circ}\text{C}/5\ \mu\text{s}$	Step size for every $5\ \mu\text{s}$ on T_{L}
T_{H} Pulse Width		80		ms	$T_{\text{A}} = 25^{\circ}\text{C}$, DH/QL conversion rate
T_{L} Pulse Width		19		ms	$T_{\text{A}} = 25^{\circ}\text{C}$, DH/QL conversion rate
Long Term Drift		0.081		$^{\circ}\text{C}$	Drift over 10 years, if part is operated at 55°C
SUPPLIES					
Supply Voltage	3		5.5	V	
Supply Current					
Normal Mode ² @ 3.3 V		370	550	μA	Nominal conversion rate
Normal Mode ² @ 5.0 V		425	650	μA	Nominal conversion rate
Quiescent ² @ 3.3 V		3	6	μA	Device not converting, output is high
Quiescent ² @ 5.0 V		5.5	10	μA	Device not converting, output is high
One Shot Mode @ 1 SPS		30.9		μA	Average current @ $V_{\text{DD}} = 3.3\text{ V}$, nominal conversion rate @ 25°C
		37.38		μA	Average current @ $V_{\text{DD}} = 5.0\text{ V}$, nominal conversion rate @ 25°C
Power Dissipation		803.33		μW	$V_{\text{DD}} = 3.3\text{ V}$, continuously converting at nominal conversion rates @ 25°C
1 SPS		101.9		μW	Average power dissipated for $V_{\text{DD}} = 3.3\text{ V}$, one shot mode @ 25°C
		186.9		μW	Average power dissipated for $V_{\text{DD}} = 5.0\text{ V}$, one shot mode @ 25°C

TMP05/TMP06

Parameter	Min	Typ	Max	Unit	Test Conditions/Comments
TMP05 OUTPUT (PUSH-PULL)³					
Output High Voltage, V_{OH}	$V_{DD} - 0.3$			V	$I_{OH} = 800 \mu A$
Output Low Voltage, V_{OL}			0.4	V	$I_{OL} = 800 \mu A$
Output High Current, I_{OUT}^4	2			mA	Typ $V_{OH} = 3.17 V$ with $V_{DD} = 3.3 V$
Pin Capacitance		10		pF	
Rise Time, ⁵ t_{LH}		50		ns	
Fall Time, ⁵ t_{HL}		50		ns	
R_{ON} Resistance (Low Output)		55		Ω	Supply and temperature dependent
TMP06 OUTPUT (OPEN DRAIN)³					
Output Low Voltage, V_{OL}			0.4	V	$I_{OL} = 1.6 mA$
Output Low Voltage, V_{OL}			1.2	V	$I_{OL} = 5.0 mA$
Pin Capacitance		10		pF	
High Output Leakage Current, I_{OH}		0.1	5	μA	$PWM_{OUT} = 5.5 V$
Device Turn-On Time		20		ms	
Fall Time, ⁶ t_{HL}		30		ns	
R_{ON} Resistance (Low Output)		55		Ω	Supply and temperature dependent
DIGITAL INPUTS³					
Input Current			± 1	μA	$V_{IN} = 0 V$ to V_{DD}
Input Low Voltage, V_{IL}			$0.3 \times V_{DD}$	V	
Input High Voltage, V_{IH}	$0.7 \times V_{DD}$			V	
Pin Capacitance	3		10	pF	

¹ It is not recommended to operate the device at temperatures above 125°C for more than a total of 5% (5,000 hours) of the lifetime of the device. Any exposure beyond this limit affects device reliability.

² Normal mode current relates to current during T_L . TMP05/TMP06 are not converting during T_H , so quiescent current relates to current during T_H .

³ Guaranteed by design and characterization, not production tested.

⁴ It is advisable to restrict the current being pulled from the TMP05 output, because any excess currents going through the die cause self-heating. As a consequence, false temperature readings can occur.

⁵ Test load circuit is 100 pF to GND.

⁶ Test load circuit is 100 pF to GND, 10 k Ω to 5.5 V.

TMP05B/TMP06B SPECIFICATIONS

All B Grade specifications apply for -40°C to $+150^{\circ}\text{C}$; V_{DD} decoupling capacitor is a 0.1 μF multilayer ceramic; $T_{\text{A}} = T_{\text{MIN}}$ to T_{MAX} , $V_{\text{DD}} = 3.0\text{ V}$ to 5.5 V , unless otherwise noted.

Table 2.

Parameter	Min	Typ	Max	Unit	Test Conditions/Comments
TEMPERATURE SENSOR AND ADC					
Nominal Conversion Rate (One Shot Mode)					See Table 7
Accuracy ¹ @ $V_{\text{DD}} = 3.3\text{ V}$ (3.0 V – 3.6 V)		± 0.5	± 1	$^{\circ}\text{C}$	$T_{\text{A}} = 25^{\circ}\text{C}$ to 70°C , $V_{\text{DD}} = 3.0\text{ V} - 3.6\text{ V}$
			± 1.25	$^{\circ}\text{C}$	$T_{\text{A}} = 0^{\circ}\text{C}$ to 70°C , $V_{\text{DD}} = 3.0\text{ V} - 3.6\text{ V}$
			± 1.5	$^{\circ}\text{C}$	$T_{\text{A}} = -40^{\circ}\text{C}$ to $+70^{\circ}\text{C}$, $V_{\text{DD}} = 3.0\text{ V} - 3.6\text{ V}$
			± 2	$^{\circ}\text{C}$	$T_{\text{A}} = -40^{\circ}\text{C}$ to $+100^{\circ}\text{C}$, $V_{\text{DD}} = 3.0\text{ V} - 3.6\text{ V}$
			± 2.5	$^{\circ}\text{C}$	$T_{\text{A}} = -40^{\circ}\text{C}$ to $+125^{\circ}\text{C}$, $V_{\text{DD}} = 3.0\text{ V} - 3.6\text{ V}$
			$\pm 3^2$	$^{\circ}\text{C}$	$T_{\text{A}} = -40^{\circ}\text{C}$ to $+150^{\circ}\text{C}$, $V_{\text{DD}} = 3.0\text{ V} - 3.6\text{ V}$
Accuracy @ $V_{\text{DD}} = 5.0\text{ V}$ (4.5 V – 5.5 V)		1.5		$^{\circ}\text{C}$	$T_{\text{A}} = 0^{\circ}\text{C}$ to 125°C , $V_{\text{DD}} = 4.5\text{ V} - 5.5\text{ V}$
Temperature Resolution		0.025		$^{\circ}\text{C}/5\ \mu\text{s}$	Step size for every 5 μs on T_{L}
T_{H} Pulse Width		40		ms	$T_{\text{A}} = 25^{\circ}\text{C}$, nominal conversion rate
T_{L} Pulse Width		76		ms	$T_{\text{A}} = 25^{\circ}\text{C}$, nominal conversion rate
Quarter Period Conversion Rate (All Operating Modes)					See Table 7
Accuracy @ $V_{\text{DD}} = 3.3\text{ V}$ (3.0 V – 3.6 V)		± 1.5		$^{\circ}\text{C}$	$T_{\text{A}} = -40^{\circ}\text{C}$ to $+150^{\circ}\text{C}$
Accuracy @ $V_{\text{DD}} = 5.0\text{ V}$ (4.5 V – 5.5 V)		± 1.5		$^{\circ}\text{C}$	$T_{\text{A}} = 0^{\circ}\text{C}$ to 125°C
Temperature Resolution		0.1		$^{\circ}\text{C}/5\ \mu\text{s}$	Step size for every 5 μs on T_{L}
T_{H} Pulse Width		10		ms	$T_{\text{A}} = 25^{\circ}\text{C}$, QP conversion rate
T_{L} Pulse Width		19		ms	$T_{\text{A}} = 25^{\circ}\text{C}$, QP conversion rate
Double High/Quarter Low Conversion Rate (All Operating Modes)					See Table 7
Accuracy @ $V_{\text{DD}} = 3.3\text{ V}$ (3.0 V – 3.6 V)		± 1.5		$^{\circ}\text{C}$	$T_{\text{A}} = -40^{\circ}\text{C}$ to $+150^{\circ}\text{C}$
Accuracy @ $V_{\text{DD}} = 5\text{ V}$ (4.5 V – 5.5 V)		± 1.5		$^{\circ}\text{C}$	$T_{\text{A}} = 0^{\circ}\text{C}$ to 125°C
Temperature Resolution		0.1		$^{\circ}\text{C}/5\ \mu\text{s}$	Step size for every 5 μs on T_{L}
T_{H} Pulse Width		80		ms	$T_{\text{A}} = 25^{\circ}\text{C}$, DH/QL conversion rate
T_{L} Pulse Width		19		ms	$T_{\text{A}} = 25^{\circ}\text{C}$, DH/QL conversion rate
Long Term Drift		0.081		$^{\circ}\text{C}$	Drift over 10 years, if part is operated at 55°C
SUPPLIES					
Supply Voltage	3		5.5	V	
Supply Current					
Normal Mode ³ @ 3.3 V		370	550	μA	Nominal conversion rate
Normal Mode ³ @ 5.0 V		425	650	μA	Nominal conversion rate
Quiescent ³ @ 3.3 V		3	6	μA	Device not converting, output is high
Quiescent ³ @ 5.0 V		5.5	10	μA	Device not converting, output is high
One Shot Mode @ 1 SPS		30.9		μA	Average current @ $V_{\text{DD}} = 3.3\text{ V}$, nominal conversion rate @ 25°C
		37.38		μA	Average current @ $V_{\text{DD}} = 5.0\text{ V}$, nominal conversion rate @ 25°C
Power Dissipation		803.33		μW	$V_{\text{DD}} = 3.3\text{ V}$, continuously converting at nominal conversion rates @ 25°C
1 SPS		101.9		μW	Average power dissipated for $V_{\text{DD}} = 3.3\text{ V}$, one shot mode @ 25°C
		186.9		μW	Average power dissipated for $V_{\text{DD}} = 5.0\text{ V}$, one shot mode @ 25°C

TMP05/TMP06

Parameter	Min	Typ	Max	Unit	Test Conditions/Comments
TMP05 OUTPUT (PUSH-PULL)⁴					
Output High Voltage, V_{OH}	$V_{DD} - 0.3$			V	$I_{OH} = 800 \mu A$
Output Low Voltage, V_{OL}			0.4	V	$I_{OL} = 800 \mu A$
Output High Current, I_{OUT}^5	2			mA	Typ $V_{OH} = 3.17 V$ with $V_{DD} = 3.3 V$
Pin Capacitance		10		pF	
Rise Time, ⁶ t_{LH}		50		ns	
Fall Time, ⁶ t_{HL}		50		ns	
R_{ON} Resistance (Low Output)		55		Ω	Supply and temperature dependent
TMP06 OUTPUT (OPEN DRAIN)⁴					
Output Low Voltage, V_{OL}			0.4	V	$I_{OL} = 1.6 mA$
Output Low Voltage, V_{OL}			1.2	V	$I_{OL} = 5.0 mA$
Pin Capacitance		10		pF	
High Output Leakage Current, I_{OH}		0.1	5	μA	$PWM_{OUT} = 5.5 V$
Device Turn-On Time		20		ms	
Fall Time, ⁷ t_{HL}		30		ns	
DIGITAL INPUTS⁴					
Input Current			± 1	μA	$V_{IN} = 0 V$ to V_{DD}
Input Low Voltage, V_{IL}			$0.3 \times V_{DD}$	V	
Input High Voltage, V_{IH}	$0.7 \times V_{DD}$			V	
Pin Capacitance	3		10	pF	

¹ The accuracy specifications for 3.0 V to 3.6 V supply range are specified to 3-sigma performance. See Figure 22.

² It is not recommended to operate the device at temperatures above 125°C for more than a total of 5% (5,000 hours) of the lifetime of the device. Any exposure beyond this limit affects device reliability.

³ Normal mode current relates to current during T_L . TMP05/TMP06 are not converting during T_H , so quiescent current relates to current during T_H .

⁴ Guaranteed by design and characterization, not production tested.

⁵ It is advisable to restrict the current being pulled from the TMP05 output, because any excess currents going through the die cause self-heating. As a consequence, false temperature readings can occur.

⁶ Test load circuit is 100 pF to GND.

⁷ Test load circuit is 100 pF to GND, 10 k Ω to 5.5 V.

TIMING CHARACTERISTICS

$T_A = T_{MIN}$ to T_{MAX} , $V_{DD} = 3.0\text{ V}$ to 5.5 V , unless otherwise noted.

Guaranteed by design and characterization, not production tested.

Table 3.

Parameter	Limit	Unit	Comments
T_H	40	ms typ	PWM high time @ 25°C under nominal conversion rate
T_L	76	ms typ	PWM low time @ 25°C under nominal conversion rate
t_3^1	50	ns typ	TMP05 output rise time
t_4^1	50	ns typ	TMP05 output fall time
t_4^2	30	ns typ	TMP06 output fall time
t_5	25	$\mu\text{s max}$	Daisy-chain start pulse width

¹ Test load circuit is 100 pF to GND.

² Test load circuit is 100 pF to GND, 10 k Ω to 5.5 V.

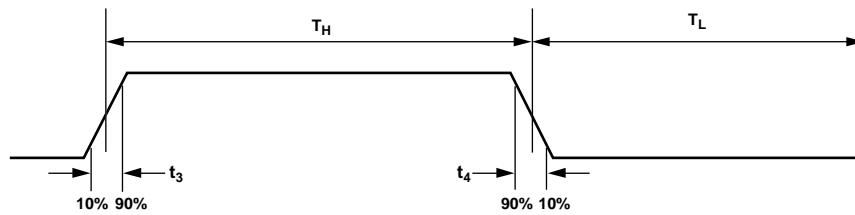

Figure 2. PWM Output Nominal Timing Diagram (25°C)

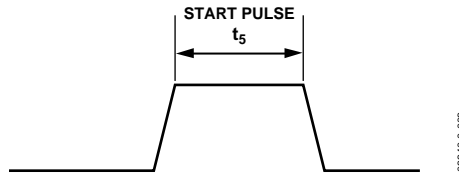

Figure 3. Daisy-Chain Start Timing

TMP05/TMP06

ABSOLUTE MAXIMUM RATINGS

Table 4.

Parameter	Rating
V _{DD} to GND	-0.3 V to +7 V
Digital Input Voltage to GND	-0.3 V to V _{DD} + 0.3 V
Maximum Output Current (OUT)	±10 mA
Operating Temperature Range ¹	-40°C to +150°C
Storage Temperature Range	-65°C to +160°C
Maximum Junction Temperature, T _{JMAX}	150°C
5-Lead SOT-23	
Power Dissipation ²	$W_{MAX} = (T_J \text{ max} - T_A^3)/\theta_{JA}$
Thermal Impedance ⁴ θ _{JA} , Junction-to-Ambient (Still Air)	240°C/W
5-Lead SC-70	
Power Dissipation ²	$W_{MAX} = (T_J \text{ max} - T_A^3)/\theta_{JA}$
Thermal Impedance ⁴ θ _{JA} , Junction-to-Ambient θ _{JC} , Junction-to-Case	207.5°C/W 172.3°C/W
IR Reflow Soldering	
Peak Temperature	220°C (0°C/5°C)
Time at Peak Temperature	10 s to 20 s
Ramp-Up Rate	2°C/s to 3°C/s
Ramp-Down Rate	-6°C/s

Stresses above those listed under Absolute Maximum Ratings may cause permanent damage to the device. This is a stress rating only; functional operation of the device at these or any other conditions above those indicated in the operational section of this specification is not implied. Exposure to absolute maximum rating conditions for extended periods may affect device reliability.

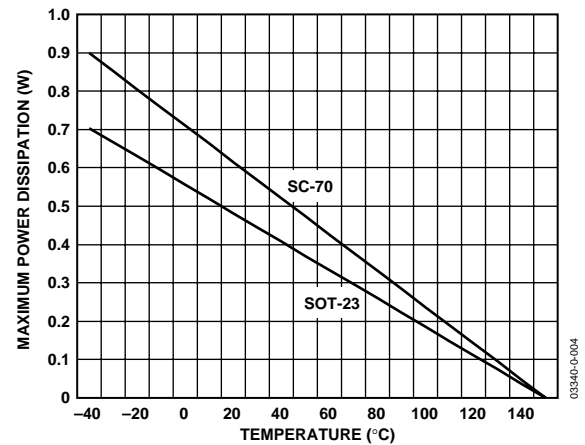

Figure 4. Maximum Power Dissipation vs. Temperature

¹ It is not recommended to operate the device at temperatures above 125°C for more than a total of 5% (5,000 hours) of the lifetime of the device. Any exposure beyond this limit affects device reliability.

² SOT-23 values relate to the package being used on a 2-layer PCB and SC-70 values relate to the package being used on a 4-layer PCB. See Figure 4 for a plot of maximum power dissipation versus ambient temperature (T_A).

³ T_A = ambient temperature.

⁴ Junction-to-case resistance is applicable to components featuring a preferential flow direction, for example, components mounted on a heat sink. Junction-to-ambient resistance is more useful for air-cooled PCB mounted components.

ESD CAUTION

ESD (electrostatic discharge) sensitive device. Electrostatic charges as high as 4000 V readily accumulate on the human body and test equipment and can discharge without detection. Although this product features proprietary ESD protection circuitry, permanent damage may occur on devices subjected to high energy electrostatic discharges. Therefore, proper ESD precautions are recommended to avoid performance degradation or loss of functionality.



PIN CONFIGURATION AND FUNCTION DESCRIPTIONS

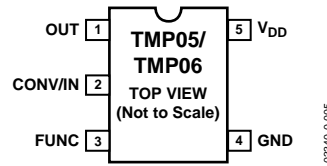

Figure 5. Pin Configuration

Table 5. Pin Function Descriptions

Pin No.	Mnemonic	Description
1	OUT	Digital Output. Pulse-width modulated (PWM) output gives a square wave whose ratio of high to low period is proportional to temperature.
2	CONV/IN	Digital Input. In continuously converting and one shot operating modes, a high, low, or float input determines the temperature measurement rate. In daisy-chain operating mode, this pin is the input pin for the PWM signal from the previous part on the daisy chain.
3	FUNC	Digital Input. A high, low, or float input on this pin gives three different modes of operation. For details, see the Operating Modes section.
4	GND	Analog and Digital Ground.
5	V _{DD}	Positive Supply Voltage, 3.0 V to 5.5 V. Use of a decoupling capacitor of 0.1 μ F as close as possible to this pin is strongly recommended.

TYPICAL PERFORMANCE CHARACTERISTICS

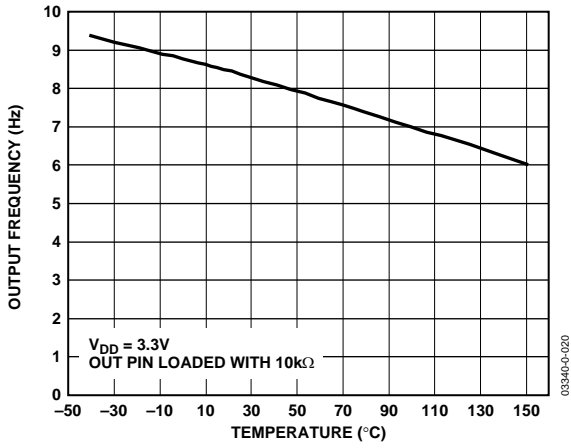

Figure 6. PWM Output Frequency vs. Temperature

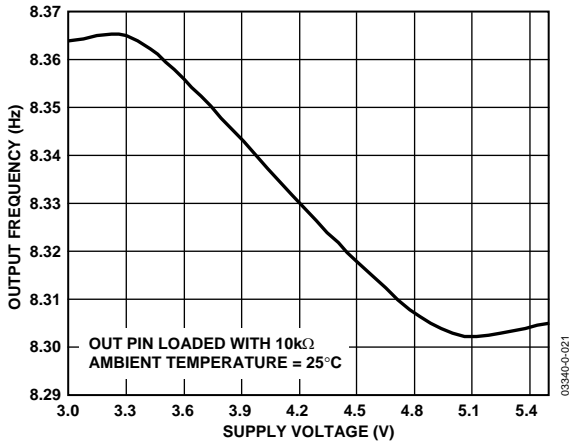

Figure 7. PWM Output Frequency vs. Supply Voltage

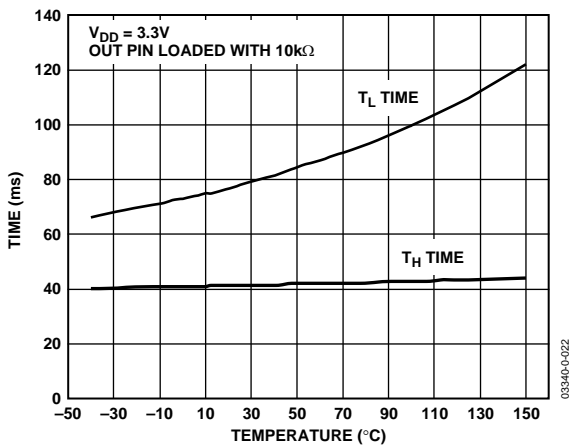

Figure 8. TH and TL Times vs. Temperature

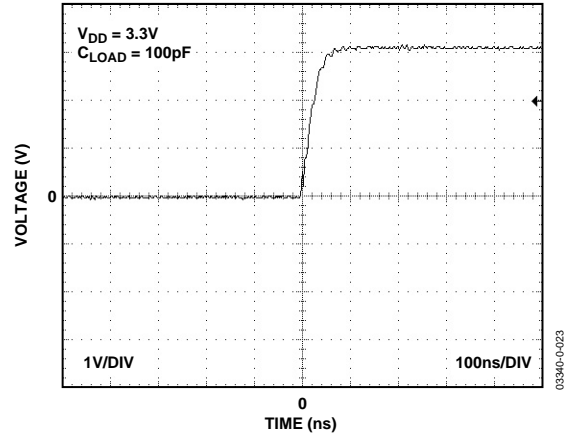

Figure 9. TMP05 Output Rise Time at 25°C

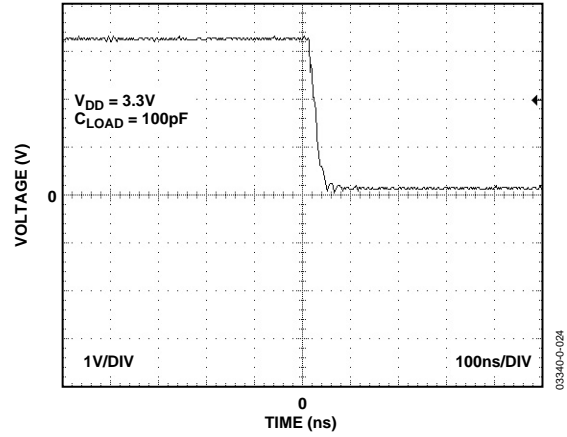

Figure 10. TMP05 Output Fall Time at 25°C

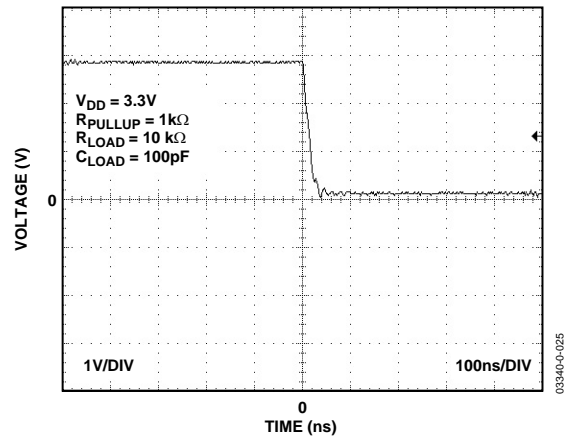

Figure 11. TMP06 Output Fall Time at 25°C

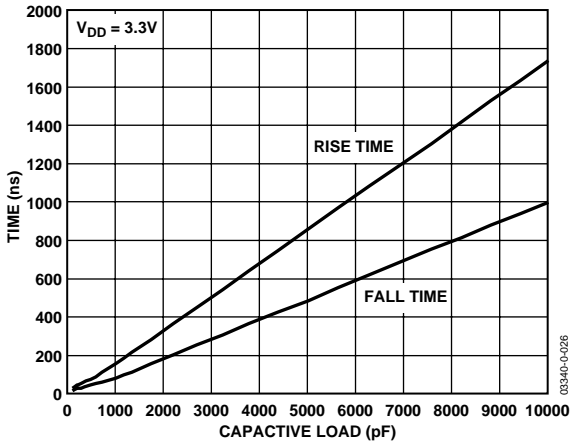

Figure 12. TMP05 Output Rise and Fall Times vs. Capacitive Load

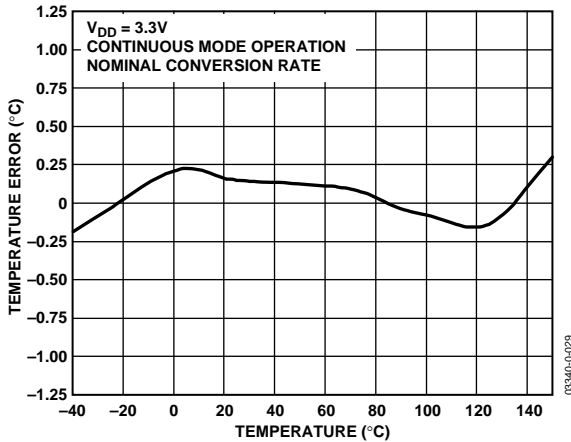

Figure 15. Output Accuracy vs. Temperature

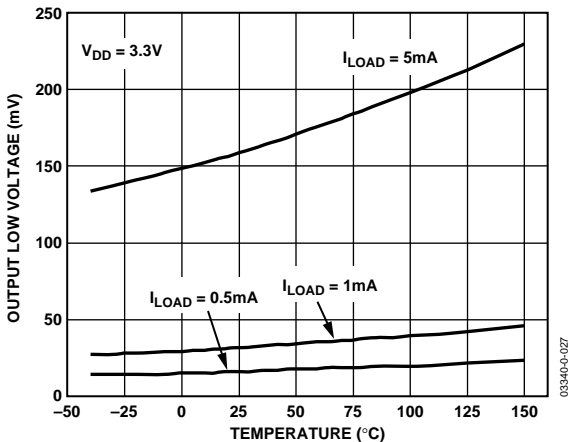

Figure 13. TMP06 Output Low Voltage vs. Temperature

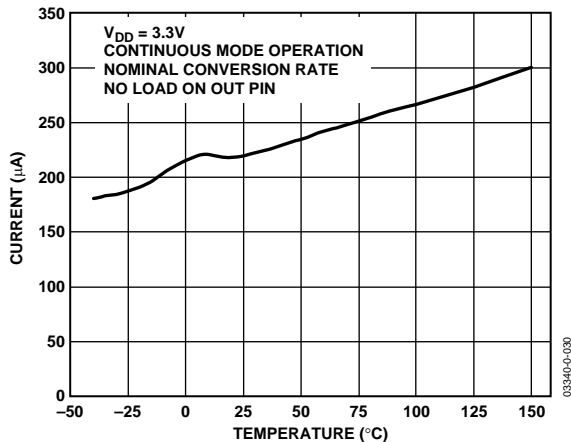

Figure 16. Supply Current vs. Temperature

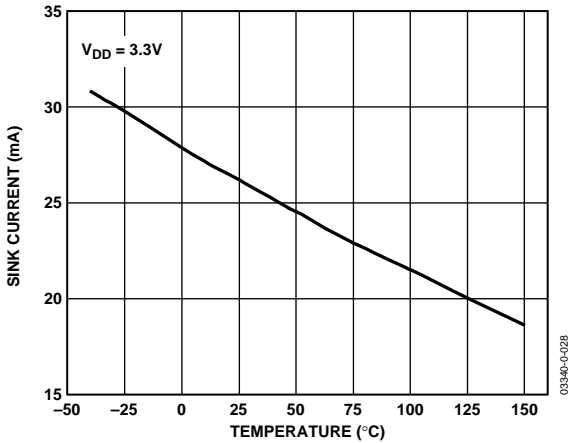

Figure 14. TMP06 Open Drain Sink Current vs. Temperature

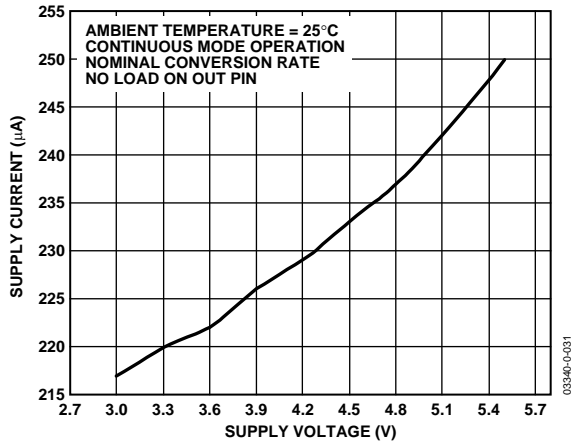

Figure 17. Supply Current vs. Supply Voltage

TMP05/TMP06

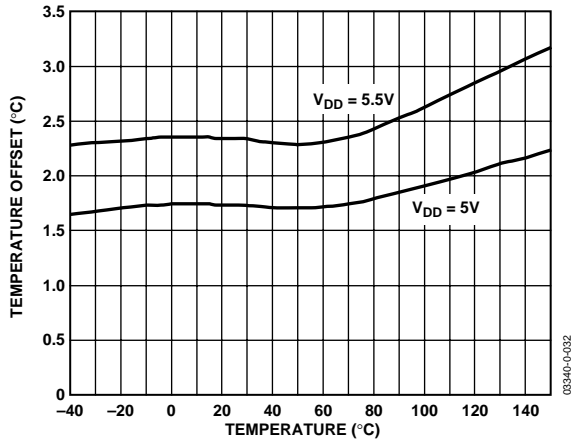

Figure 18. Temperature Offset vs. Power Supply Variation from 3.3V

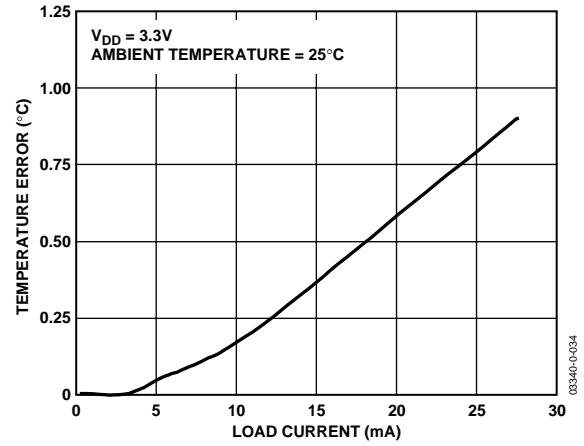

Figure 20. TMP05 Temperature Error vs. Load Current

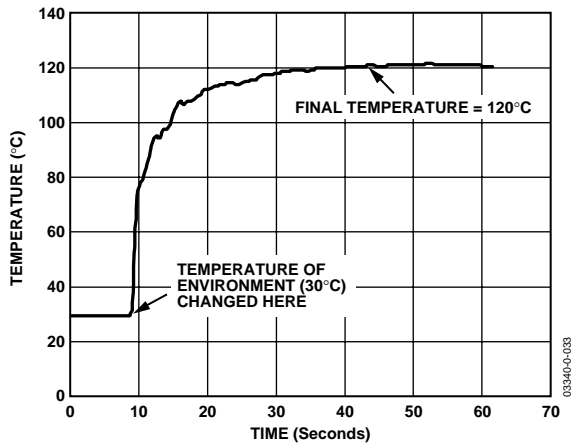

Figure 19. Response to Thermal Shock

THEORY OF OPERATION

CIRCUIT INFORMATION

The TMP05/TMP06 are monolithic temperature sensors that generate a modulated serial digital output that varies in direct proportion with the temperature of the device. An on-board sensor generates a voltage precisely proportional to absolute temperature, which is compared to an internal voltage reference and is input to a precision digital modulator. The ratiometric encoding format of the serial digital output is independent of the clock drift errors common to most serial modulation techniques such as voltage-to-frequency converters. Overall accuracy for the A Grade is $\pm 2^{\circ}\text{C}$ from 0°C to $+70^{\circ}\text{C}$, with excellent transducer linearity. B Grade accuracy is $\pm 1^{\circ}\text{C}$ from 25°C to 70°C . The digital output of the TMP05 is CMOS/TTL compatible, and is easily interfaced to the serial inputs of most popular microprocessors. The open-drain output of the TMP06 is capable of sinking 5 mA.

The on-board temperature sensor has excellent accuracy and linearity over the entire rated temperature range without correction or calibration by the user.

The sensor output is digitized by a first-order Σ - Δ modulator, also known as the charge balance type analog-to-digital converter. This type of converter utilizes time-domain oversampling and a high accuracy comparator to deliver 12 bits of effective accuracy in an extremely compact circuit.

CONVERTER DETAILS

The Σ - Δ modulator consists of an input sampler, a summing network, an integrator, a comparator, and a 1-bit DAC. Similar to the voltage-to-frequency converter, this architecture creates, in effect, a negative feedback loop whose intent is to minimize the integrator output by changing the duty cycle of the comparator output in response to input voltage changes. The comparator samples the output of the integrator at a much higher rate than the input sampling frequency, which is called oversampling. Oversampling spreads the quantization noise over a much wider band than that of the input signal, improving overall noise performance and increasing accuracy.

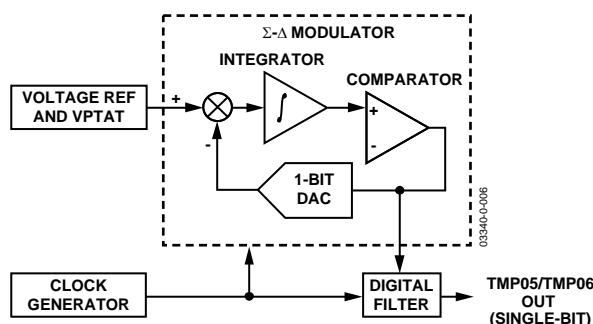

Figure 21. First-Order Σ - Δ Modulator

The modulated output of the comparator is encoded using a circuit technique that results in a serial digital signal with a mark-space ratio format. This format is easily decoded by any microprocessor into either $^{\circ}\text{C}$ or $^{\circ}\text{F}$ values, and is readily transmitted or modulated over a single wire. More importantly, this encoding method neatly avoids major error sources common to other modulation techniques, because it is clock-independent.

FUNCTIONAL DESCRIPTION

The output of the TMP05/TMP06 is a square wave with a typical period of 116 ms at 25°C (CONV/IN pin is left floating). The high period, T_H , is constant, while the low period, T_L , varies with measured temperature. The output format for the nominal conversion rate is readily decoded by the user as follows:

$$\text{Temperature } (^{\circ}\text{C}) = 421 - (751 \times (T_H/T_L)) \quad (1)$$



Figure 22. TMP05/TMP06 Output Format

The time periods T_H (high period) and T_L (low period) are values easily read by a microprocessor timer/counter port, with the above calculations performed in software. Because both periods are obtained consecutively using the same clock, performing the division indicated in the previous formula results in a ratiometric value that is independent of the exact frequency or drift of either the originating clock of the TMP05/TMP06 or the user's counting clock.

OPERATING MODES

The user can program the TMP05/TMP06 to operate in three different modes by configuring the FUNC pin on power-up as either low, floating, or high.

Table 6. Operating Modes

FUNC Pin	Operating Mode
Low	One shot
Floating	Continuously converting
High	Daisy-chain

Continuously Converting Mode

In continuously converting mode, the TMP05/TMP06 continuously output a square wave representing temperature. The frequency at which this square wave is output is determined by the state of the CONV/IN pin on power-up. Any change to the state of the CONV/IN pin after power-up is not reflected in the parts until the TMP05/TMP06 are powered down and back up.

TMP05/TMP06

One Shot Mode

In one shot mode, the TMP05/TMP06 output one square wave representing temperature when requested by the microcontroller. The microcontroller pulls the OUT pin low and then releases it to indicate to the TMP05/TMP06 that an output is required. The temperature measurement is output when the OUT line is released by the microcontroller (see Figure 23).

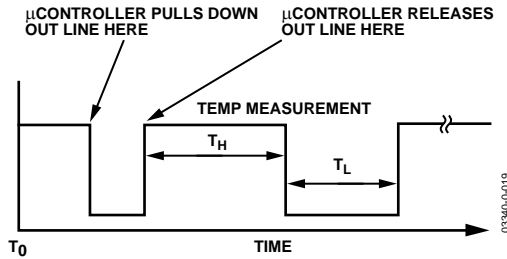

Figure 23. TMP05/TMP06 One Shot OUT Pin Signal

In the TMP05 one shot mode only, an internal resistor is switched in series with the pull-up MOSFET. The TMP05 OUT pin has a push-pull output configuration (see Figure 24), and, therefore, needs a series resistor to limit the current drawn on this pin when the user pulls it low to start a temperature conversion. This series resistance prevents any short circuit from V_{DD} to GND, and, therefore, protects the TMP05 from short-circuit damage.

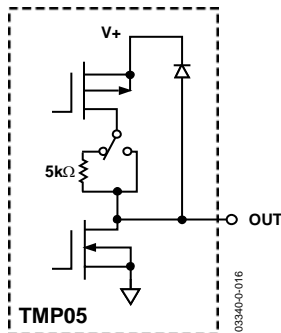

Figure 24. TMP05 One Shot Mode OUT Pin Configuration

The advantages of the one shot mode include lower average power consumption, and the microcontroller knows that the first low-to-high transition occurs after the microcontroller releases the OUT pin.

Conversion Rate

In continuously converting and one shot modes, the state of the CONV/IN pin on power-up determines the rate at which the TMP05/TMP06 measure temperature. The available conversion rates are shown in Table 7.

Table 7. Conversion Rates

CONV/IN Pin	Conversion Rate	T_H/T_L (25°C)
Low	Quarter period ($T_H \div 4, T_L \div 4$)	10/19 (ms)
Floating	Nominal	40/76 (ms)
High	Double high ($T_H \times 2$) Quarter low ($T_L \div 4$)	80/19 (ms)

The TMP05 (push-pull output) advantage when using the high state conversion rate (double high/quarter low) is lower power consumption. However, the trade-off is loss of resolution on the low time. Depending on the state of the CONV/IN pin, two different temperature equations must be used.

The temperature equation for the low and floating states' conversion rates is

$$\text{Temperature (°C)} = 421 - (751 \times (T_H/T_L)) \quad (2)$$

Table 8. Conversion Times Using Equation 2

Temperature (°C)	T_L (ms)	Nominal Cycle Time (ms)
-40	65.2	105
-30	66.6	107
-20	68.1	108
-10	69.7	110
0	71.4	111
10	73.1	113
20	74.9	115
25	75.9	116
30	76.8	117
40	78.8	119
50	81	121
60	83.2	123
70	85.6	126
80	88.1	128
90	90.8	131
100	93.6	134
110	96.6	137
120	99.8	140
130	103.2	143
140	106.9	147
150	110.8	151

The temperature equation for the high state conversion rate is

$$\text{Temperature } (^{\circ}\text{C}) = 421 - (93.875 \times (T_H/T_L)) \quad (3)$$

Table 9. Conversion Times Using Equation 3

Temperature (°C)	T _L (ms)	High Cycle Time (ms)
-40	16.3	96.2
-30	16.7	96.6
-20	17	97.03
-10	17.4	97.42
0	17.8	97.84
10	18.3	98.27
20	18.7	98.73
25	19	98.96
30	19.2	99.21
40	19.7	99.71
50	20.2	100.24
60	20.8	100.8
70	21.4	101.4
80	22	102.02
90	22.7	102.69
100	23.4	103.4
110	24.1	104.15
120	25	104.95
130	25.8	105.81
140	26.7	106.73
150	27.7	107.71

Daisy-Chain Mode

Setting the FUNC pin to a high state allows multiple TMP05/TMP06s to be connected together and, therefore, allows one input line of the microcontroller to be the sole receiver of all temperature measurements. In this mode, the CONV/IN pin operates as the input of the daisy chain, and conversions take place at the nominal conversion rate of $T_H/T_L = 40 \text{ ms} / 76 \text{ ms}$ at 25°C.

Therefore, the temperature equation for the daisy-chain mode of operation is

$$\text{Temperature } (^{\circ}\text{C}) = 421 - (751 \times (T_H/T_L)) \quad (4)$$

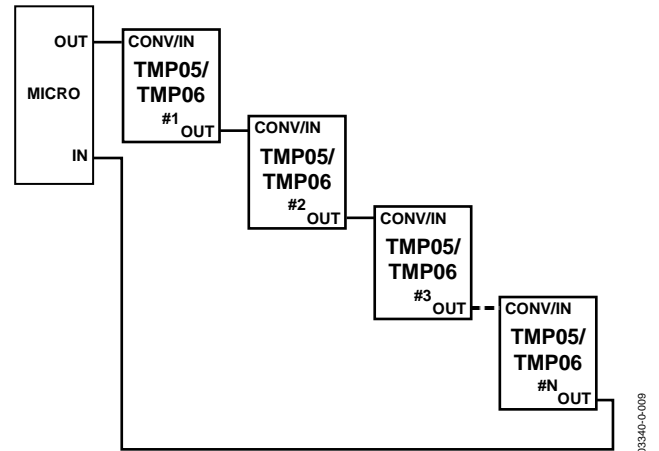

Figure 25. Daisy-Chain Structure

A second microcontroller line is needed to generate the conversion start pulse on the CONV/IN pin. The pulse width of the start pulse should be less than 25 μs. The start pulse on the CONV/IN pin lets the first TMP05/TMP06 part know that it should start a conversion and output its own temperature now. Once the part has output its own temperature, it then outputs a start pulse for the next part on the daisy-chain link. The pulse width of the start pulse from each TMP05/TMP06 part is typically 17 μs.

Figure 26 shows the start pulse on the CONV/IN pin of the first device on the daisy chain and Figure 27 shows the PWM output by this first part.

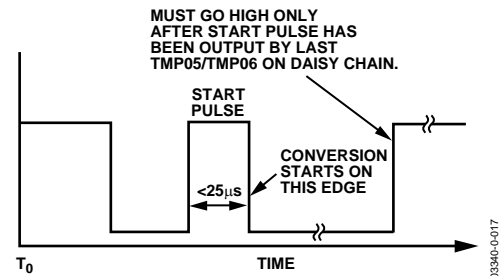

Figure 26. Start Pulse at CONV/IN Pin of First TMP05/TMP06 Device on Daisy Chain

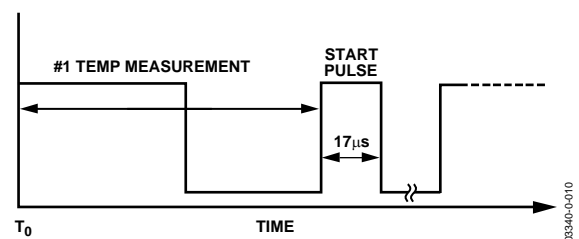

Figure 27. Daisy-Chain Temperature Measurement and Start Pulse Output from First TMP05/TMP06

TMP05/TMP06

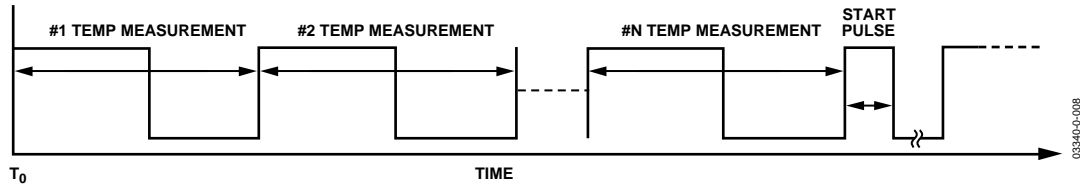

Figure 28. Daisy-Chain Signal at Input to the Microcontroller

Before the start pulse reaches a TMP05/TMP06 part in the daisy chain, the device acts as a buffer for the previous temperature measurement signals. Each part monitors the PWM signal for the start pulse from the previous part. Once the part detects the start pulse, it initiates a conversion and inserts the result at the end of the daisy-chain PWM signal. It then inserts a start pulse for the next part in the link. The final signal input to the microcontroller should look like Figure 28. The input signal on Pin 2 (IN) of the first daisy-chain device must remain low until the last device has output its start pulse.

If the input on Pin 2 (IN) goes high and remains high, the TMP05/TMP06 part powers down between 0.3 s and 1.2 s later. The part, therefore, requires another start pulse to generate another temperature measurement. Note that, to reduce power dissipation through the part, it is recommended to keep Pin 2 (IN) at a high state when the part is not converting. If the IN pin is at 0 V, then the OUT pin is at 0 V (because it is acting as a buffer when not converting), and drawing current through either the pull-up MOSFET (TMP05) or the pull-up resistor (TMP06).

TMP05 OUTPUT

The TMP05 has a push-pull CMOS output (Figure 29) and provides rail-to-rail output drive for logic interfaces. The rise and fall times of the TMP05 output are closely matched, so that errors caused by capacitive loading are minimized. If load capacitance is large (for example, when driving a long cable), an external buffer might improve accuracy.

An internal resistor is connected in series with the pull-up MOSFET when the TMP05 is operating in one shot mode.

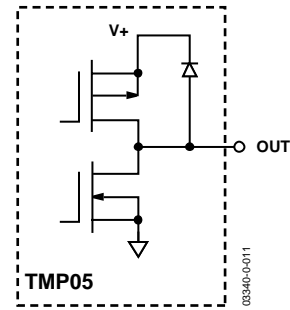

Figure 29. TMP05 Digital Output Structure

TMP06 OUTPUT

The TMP06 has an open-drain output. Because the output source current is set by the pull-up resistor, output capacitance should be minimized in TMP06 applications. Otherwise, unequal rise and fall times skew the pulse width and introduce measurement errors.

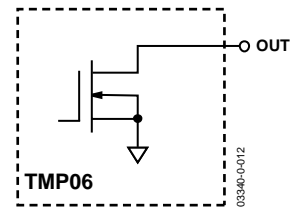

Figure 30. TMP06 Digital Output Structure

APPLICATION HINTS

THERMAL RESPONSE TIME

The time required for a temperature sensor to settle to a specified accuracy is a function of the thermal mass of the sensor and the thermal conductivity between the sensor and the object being sensed. Thermal mass is often considered equivalent to capacitance. Thermal conductivity is commonly specified using the symbol Q , and can be thought of as thermal resistance. It is commonly specified in units of degrees per watt of power transferred across the thermal joint. Thus, the time required for the TMP05/TMP06 to settle to the desired accuracy is dependent on the package selected, the thermal contact established in that particular application, and the equivalent power of the heat source. In most applications, the settling time is probably best determined empirically.

SELF-HEATING EFFECTS

The temperature measurement accuracy of the TMP05/TMP06 might be degraded in some applications due to self-heating. Errors introduced are from the quiescent dissipation and power dissipated when converting, that is, during T_L . The magnitude of these temperature errors is dependent on the thermal conductivity of the TMP05/TMP06 package, the mounting technique, and the effects of airflow. Static dissipation in the TMP05/TMP06 is typically 10 W operating at 3.3 V with no load. In the 5-lead SC-70 package mounted in free air, this accounts for a temperature increase due to self-heating of

$$\Delta T = P_{DISS} \times \theta_{JA} = 10 \mu\text{W} \times 211.4^\circ\text{C}/\text{W} = 0.0021^\circ\text{C} \quad (5)$$

In addition, power is dissipated by the digital output, which is capable of sinking 800 μA continuously (TMP05). Under an 800 μA load, the output can dissipate

$$P_{DISS} = (0.4 \text{ V})(0.8 \text{ mA})((T_L)/T_H + T_L) \quad (6)$$

For example, with $T_L = 80 \text{ ms}$ and $T_H = 40 \text{ ms}$, the power dissipation due to the digital output is approximately 0.21 mW. In a free-standing SC-70 package, this accounts for a temperature increase due to self-heating of

$$\Delta T = P_{DISS} \times \theta_{JA} = 0.21 \text{ mW} \times 211.4^\circ\text{C}/\text{W} = 0.044^\circ\text{C} \quad (7)$$

This temperature increase adds directly to that from the quiescent dissipation and affects the accuracy of the TMP05/TMP06 relative to the true ambient temperature.

It is recommended that current dissipated through the device be kept to a minimum, because it has a proportional effect on the temperature error.

SUPPLY DECOUPLING

The TMP05/TMP06 should be decoupled with a 0.1 μF ceramic capacitor between V_{DD} and GND. This is particularly important, if the TMP05/TMP06 are mounted remotely from the power supply. Precision analog products such as the TMP05/TMP06 require a well-filtered power source. Because the TMP05/TMP06 operate from a single supply, it might seem convenient to simply tap into the digital logic power supply. Unfortunately, the logic supply is often a switch-mode design, which generates noise in the 20 kHz to 1 MHz range. In addition, fast logic gates can generate glitches hundreds of mV in amplitude due to wiring resistance and inductance.

If possible, the TMP05/TMP06 should be powered directly from the system power supply. This arrangement, shown in Figure 31, isolates the analog section from the logic switching transients. Even if a separate power supply trace is not available, however, generous supply bypassing reduces supply-line-induced errors. Local supply bypassing consisting of a 0.1 μF ceramic capacitor is critical for the temperature accuracy specifications to be achieved. This decoupling capacitor must be placed as close as possible to the TMP05/TMP06's V_{DD} pin. A recommended decoupling capacitor is Phicomp's 100 nF, 50 V X74.

Keep the capacitor package size as small as possible, because ESL (equivalent series inductance) increases with increasing package size. Reducing the capacitive value below 100 nF increases the ESR (equivalent series resistance). Use of a capacitor with an ESL of 1 nH and an ESR of 80 m Ω is recommended.

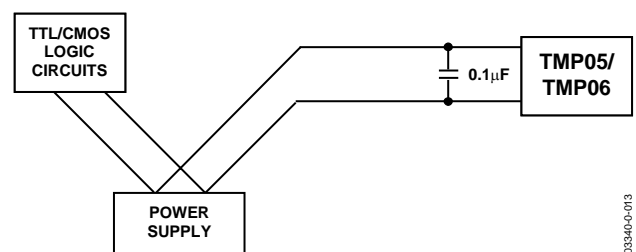

Figure 31. Use Separate Traces to Reduce Power Supply Noise

03340-0-013

TMP05/TMP06

TEMPERATURE MONITORING

The TMP05/TMP06 are ideal for monitoring the thermal environment within electronic equipment. For example, the surface-mounted package accurately reflects the exact thermal conditions that affect nearby integrated circuits.

The TMP05/TMP06 measure and convert the temperature at the surface of their own semiconductor chip. When the TMP05/TMP06 are used to measure the temperature of a nearby heat source, the thermal impedance between the heat source and the TMP05/TMP06 must be considered. Often, a thermocouple or other temperature sensor is used to measure the temperature of the source, while the TMP05/TMP06 temperature is monitored by measuring T_H and T_L . Once the thermal impedance is determined, the temperature of the heat source can be inferred from the TMP05/TMP06 output.

One example of using the TMP05/TMP06's unique properties is in monitoring a high power dissipation microprocessor. The TMP05/TMP06 part, in a surface-mounted package, is mounted directly beneath the microprocessor's pin grid array (PGA) package. In a typical application, the TMP05/TMP06's output is connected to an ASIC, where the pulse width is measured. The TMP05/TMP06 pulse output provides a significant advantage in this application, because it produces a linear temperature output while needing only one I/O pin and without requiring an ADC.

DAISY-CHAIN APPLICATION

This section provides an example of how to connect two TMP05s in daisy-chain mode to a standard 8052 microcontroller core. The ADuC812 is the microcontroller used in the following example and has the 8052 as its core processing engine. Figure 32 shows how to interface to the 8052 core device. TMP05 Program Code Example 1 shows how to communicate from the ADuC812 to the two daisy-chained TMP05s. This code can also be used with the ADuC831 or any microprocessor running on an 8052 core.

Figure 32 is a diagram of the input waveform into the ADuC812 from the TMP05 daisy chain, and it shows how the code's variables are assigned. It should be referenced when reading TMP05 Program Code Example 1. Application notes are available on the Analog Devices Web site showing the TMP05 working with other types of microcontrollers.

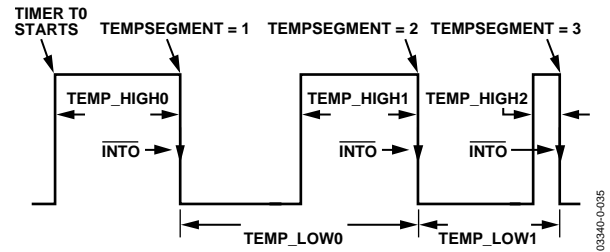

Figure 32. Reference Diagram for Software Variables in TMP05 Program Code Example 1

Figure 33 shows how the three devices are hardwired together. Figure 34 to Figure 36 are flow charts for this program.

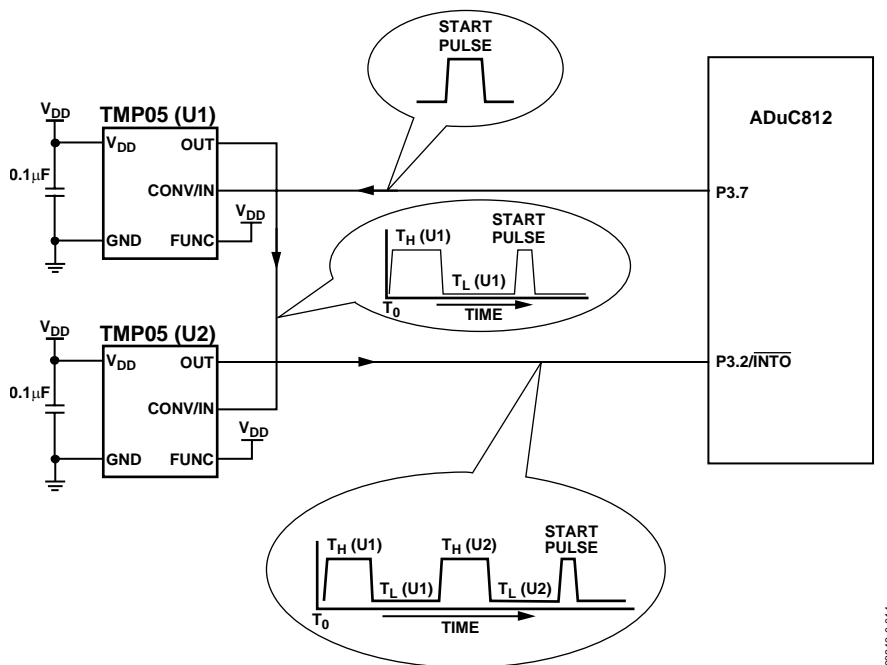

Figure 33. Typical Daisy-Chain Application Circuit

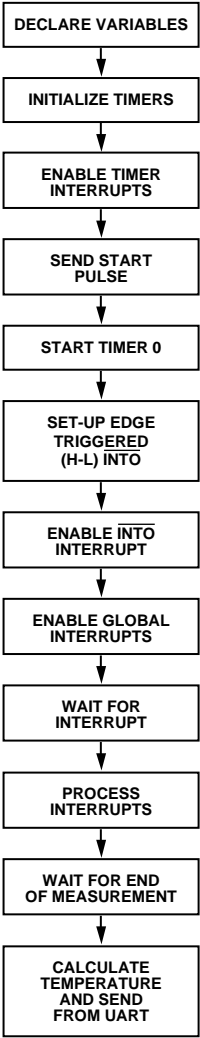

Figure 34. ADuC812 Main Routine Flowchart

03340-0-036

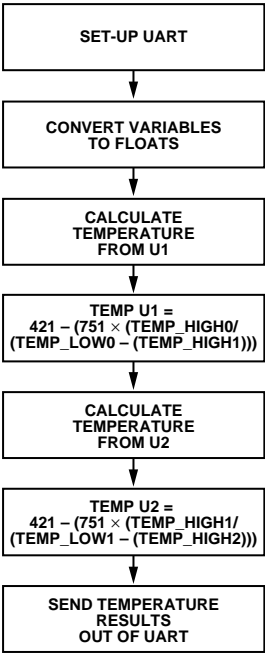
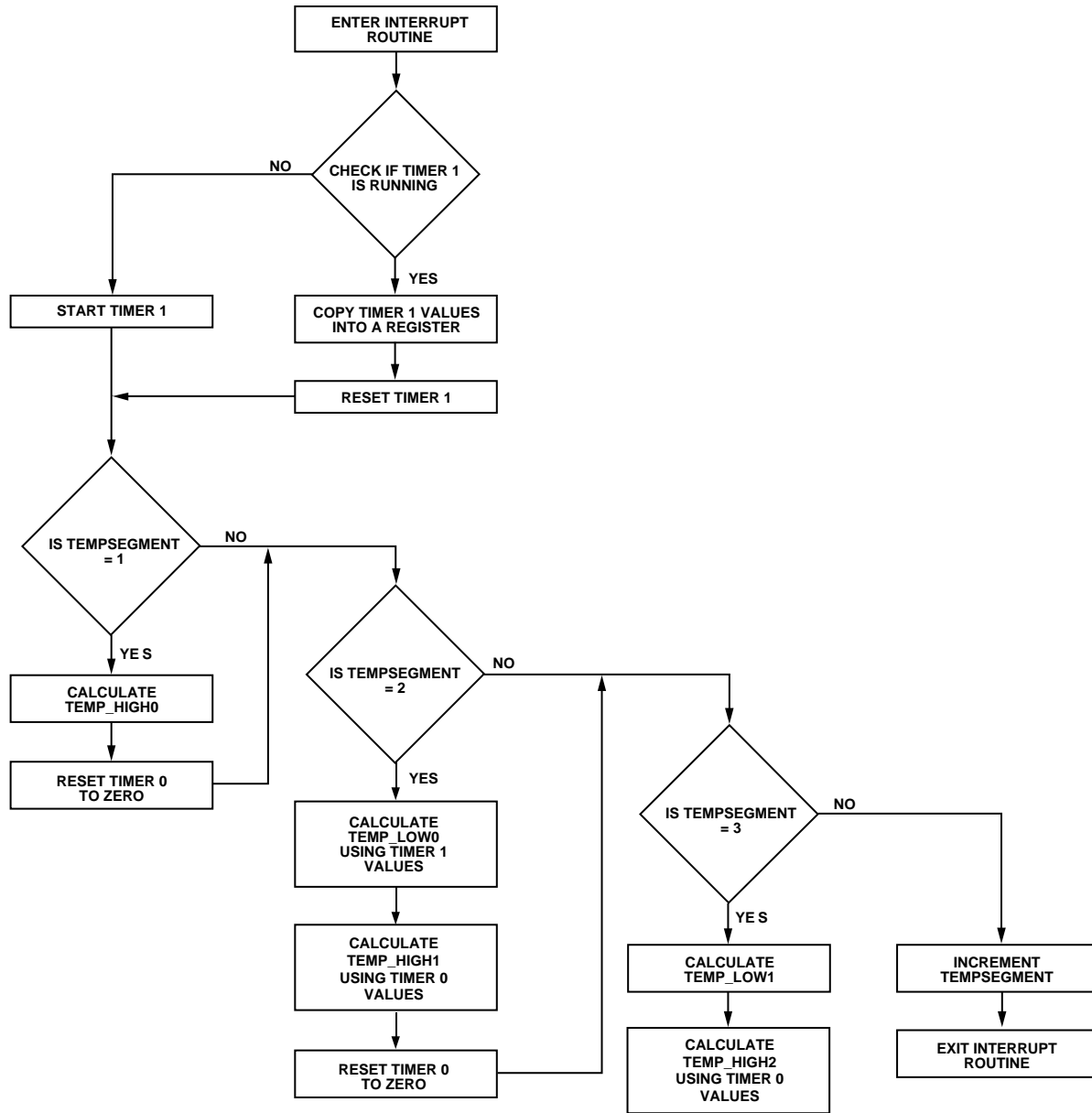

Figure 35. ADuC812 Temperature Calculation Routine Flowchart

03340-0-038

TMP05/TMP06



03340-0-037

Figure 36. ADuC812 Interrupt Routine Flowchart

TMP05 Program Code Example 1

```

//=====
// Description : This program reads the temperature from 2 daisy-chained TMP05 parts.
//
// This code runs on any standard 8052 part running at 11.0592MHz.
// If an alternative core frequency is used, the only change required is an
// adjustment of the baud rate timings.
//
// P3.2 = Daisy-chain output connected to INT0.
// P3.7 = Conversion control.
// Timer0 is used in gate mode to measure the high time.
// Timer1 is triggered on a high-to-low transition of INT0 and is used to measure
// the low time.
//=====
  
```

```

#include <stdio.h>
#include <ADuC812.h> //ADuC812 SFR definitions
void delay(int);
sbit Daisy_Start_Pulse = 0xB7; //Daisy_Start_Pulse = P3.7
sbit P3_4 = 0xB4;
long temp_high0,temp_low0,temp_high1,temp_low1,temp_high2,th,tl; //Global variables to allow
//access during ISR.
//See Figure 32.

int timer0_count=0,timer1_count=0,tempsegment=0;

void int0 () interrupt 0 //INT0 Interrupt Service Routine
{
if (TR1 == 1)
{
th = TH1;
tl = TL1;
th = TH1; //To avoid misreading timer
TL1 = 0;
TH1 = 0;
}
TR1=1; //Start timer1 running, if not running
Already

if (tempsegment == 1)
{
temp_high0 = (TH0*0x100+TL0)+(timer0_count*65536); //Convert to integer
TH0=0x00; //Reset count
TL0=0x00;
timer0_count=0;
}
if (tempsegment == 2)
{
temp_low0 = (th*0x100+tl)+(timer1_count*65536); //Convert to integer
temp_high1 = (TH0*0x100+TL0)+(timer0_count*65536); //Convert to integer
TH0=0x00; //Reset count
TL0=0x00;
timer0_count=0;
timer1_count=0;
}
if (tempsegment == 3)
{
temp_low1 = (th*0x100+tl)+(timer1_count*65536); //Convert to integer
temp_high2 = (TH0*0x100+TL0)+(timer0_count*65536);
TH0=0x00; //Reset count
TL0=0x00;
timer0_count=0;
timer1_count=0;
}

tempsegment++;
}

void timer0 () interrupt 1
{
timer0_count++; //Keep a record of timer0 overflows
}
void timer1 () interrupt 3
{
timer1_count++; //Keep a record of timer1 overflows
}

```

TMP05/TMP06

```
}
void main(void)
{
double temp1=0,temp2=0;
double T1,T2,T3,T4,T5;

// Initialization
TMOD = 0x19; // Timer1 in 16-bit counter mode
// Timer0 in 16-bit counter mode

// with gate on INT0. Timer0 only counts when INT0 pin // is high.
ET0 = 1; // Enable timer0 interrupts
ET1 = 1; // Enable timer1 interrupts
tempsegment = 1; // Initialize segment

Daisy_Start_Pulse = 0; // Pull P3.7 low

// Start Pulse
Daisy_Start_Pulse = 1;
Daisy_Start_Pulse = 0; //Toggle P3.7 to give start pulse
// Set T0 to count the high period
TR0 = 1; // Start timer0 running
IT0 = 1; // Interrupt0 edge triggered

EX0 = 1; // Enable interrupt
EA = 1; // Enable global interrupts
for(;;)
{
if (tempsegment == 4)
break;
}

//CONFIGURE UART
SCON = 0x52 ; // 8-bit, no parity, 1 stop bit
TMOD = 0x20 ; // Configure timer1..
TH1 = 0xFD ; // ..for 9600baud..
TR1 = 1; // ..(assuming 11.0592MHz crystal)

//Convert variables to floats for calculation
T1= temp_high0;
T2= temp_low0;
T3= temp_high1;
T4= temp_low1;
T5= temp_high2;

temp1=421-(751*(T1/(T2-T3)));
temp2=421-(751*(T3/(T4-T5)));
printf("Temp1 = %f\nTemp2 = %f\n",temp1,temp2); //Sends temperature result out UART

while (1); // END of program

}

// Delay routine
void delay(int length)
{
while (length >=0)
length--;
}
}
```

CONTINUOUSLY CONVERTING APPLICATION

This section provides an example of how to connect one TMP05 in continuously converting mode to a microchip PIC16F876 microcontroller. Figure 37 shows how to interface to the PIC16F876.

TMP05 Program Code Example 2 shows how to communicate from the microchip device to the TMP05. This code can also be used with other PICs by simply changing the include file for the part.

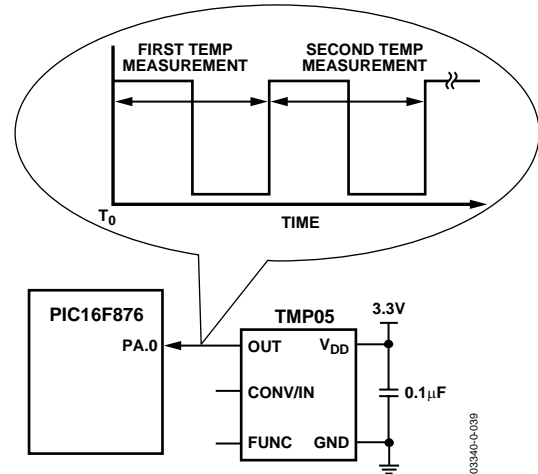

Figure 37. Typical Daisy-Chain Application Circuit

TMP05 Program Code Example 2

```
//=====
//
// Description : This program reads the temperature from a TMP05 part set up in continuously
// converting mode.
// This code was written for a PIC16F876, but can be easily configured to function with other
// PICs by simply changing the include file for the part.
//
//      Fosc = 4MHz
//      Compiled under CCS C compiler IDE version 3.4
//      PWM output from TMP05 connected to PortA.0 of PIC16F876
//
//=====
#include <16F876.h>           // Insert header file for the particular PIC being used
#define adc=8
#include <delay.h>
#include <adc.h>
#include <timer1.h>
#include <ports.h>
#include <math.h>

//_____ Wait for high function_____
void wait_for_high() {
    while(input(PIN_A0)) ;    /* while high, wait for low */
    while(!input(PIN_A0));   /* wait for high */
}
//_____ Wait for low function_____
void wait_for_low() {
    while(!input(PIN_A0));   /* wait for high */
}
//_____ Main begins here_____
void main(){
    long int high_time,low_time,temp;

    setup_adc_ports(NO_ANALOGS);
    setup_adc(ADC_OFF);
    setup_spi(FALSE);

    setup_timer_1 ( T1_INTERNAL | T1_DIV_BY_2);    //Sets up timer to overflow after 131.07ms
```

TMP05/TMP06

```
do{
    wait_for_high();
    set_timer1(0); //Reset timer
    wait_for_low();
    high_time = get_timer1();
    set_timer1(0); //Reset timer
    wait_for_high();
    low_time = get_timer1();

    temp = 421 - ((751 * high_time)/low_time); //Temperature equation for the high state
                                                //conversion rate.
                                                //Temperature value stored in temp as a long int
}while (TRUE);
}
```

OUTLINE DIMENSIONS

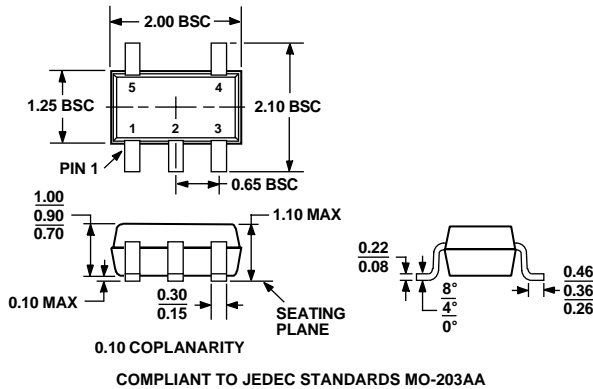

Figure 38. 5-Lead Thin Shrink Small Outline Transistor Package [SC-70] (KS-5)
Dimensions shown in millimeters

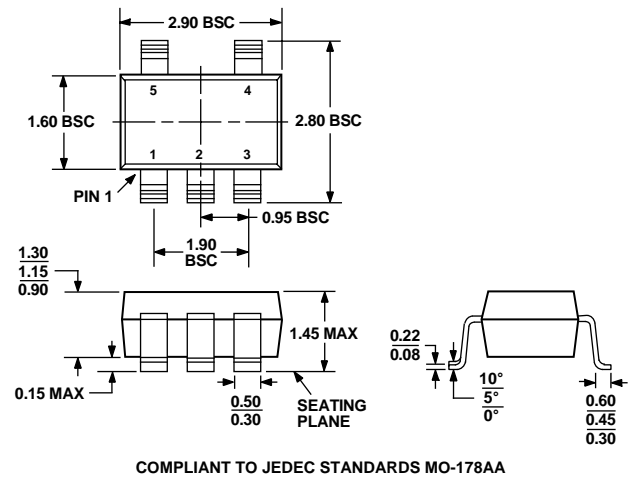

Figure 39. 5-Lead Small Outline Transistor Package [SOT-23] (RJ-5)
Dimensions shown in millimeters

ORDERING GUIDE

Model	Minimum Quantities/Reel	Temperature Range ¹	Temperature Accuracy ²	Package Description	Package Option	Branding
TMP05AKS-500RL7	500	-40°C to +150°C	±2°C	5-Lead SC-70	KS-5	T8A
TMP05AKS-REEL	10000	-40°C to +150°C	±2°C	5-Lead SC-70	KS-5	T8A
TMP05AKS-REEL7	3000	-40°C to +150°C	±2°C	5-Lead SC-70	KS-5	T8A
TMP05ART-500RL7	500	-40°C to +150°C	±2°C	5-Lead SOT-23 ³	RJ-5	T8A
TMP05ART-REEL	10000	-40°C to +150°C	±2°C	5-Lead SOT-23 ³	RJ-5	T8A
TMP05ART-REEL7	3000	-40°C to +150°C	±2°C	5-Lead SOT-23 ³	RJ-5	T8A
TMP05BKS-500RL7	500	-40°C to +150°C	±1°C	5-Lead SC-70	KS-5	T8B
TMP05BKS-REEL	10000	-40°C to +150°C	±1°C	5-Lead SC-70	KS-5	T8B
TMP05BKS-REEL7	3000	-40°C to +150°C	±1°C	5-Lead SC-70	KS-5	T8B
TMP05BRT-500RL7	500	-40°C to +150°C	±1°C	5-Lead SOT-23 ³	RJ-5	T8B
TMP05BRT-REEL	10000	-40°C to +150°C	±1°C	5-Lead SOT-23 ³	RJ-5	T8B
TMP05BRT-REEL7	3000	-40°C to +150°C	±1°C	5-Lead SOT-23 ³	RJ-5	T8B
TMP05AKSZ-500RL7 ⁴	500	-40°C to +150°C	±2°C	5-Lead SC-70	KS-5	T8C
TMP05AKSZ-REEL ⁴	10000	-40°C to +150°C	±2°C	5-Lead SC-70	KS-5	T8C
TMP05AKSZ-REEL7 ⁴	3000	-40°C to +150°C	±2°C	5-Lead SC-70	KS-5	T8C
TMP05ARTZ-500RL7 ⁴	500	-40°C to +150°C	±2°C	5-Lead SOT-23 ³	RJ-5	T8C
TMP05ARTZ-REEL ⁴	10000	-40°C to +150°C	±2°C	5-Lead SOT-23 ³	RJ-5	T8C
TMP05ARTZ-REEL7 ⁴	3000	-40°C to +150°C	±2°C	5-Lead SOT-23 ³	RJ-5	T8C
TMP05BKSZ-500RL7 ⁴	500	-40°C to +150°C	±1°C	5-Lead SC-70	KS-5	T8D
TMP05BKSZ-REEL ⁴	10000	-40°C to +150°C	±1°C	5-Lead SC-70	KS-5	T8D
TMP05BKSZ-REEL7 ⁴	3000	-40°C to +150°C	±1°C	5-Lead SC-70	KS-5	T8D
TMP05BRTZ-500RL7 ⁴	500	-40°C to +150°C	±1°C	5-Lead SOT-23 ³	RJ-5	T8D
TMP05BRTZ-REEL ⁴	10000	-40°C to +150°C	±1°C	5-Lead SOT-23 ³	RJ-5	T8D
TMP05BRTZ-REEL7 ⁴	3000	-40°C to +150°C	±1°C	5-Lead SOT-23 ³	RJ-5	T8D

TMP05/TMP06

Model	Minimum Quantities/Reel	Temperature Range ¹	Temperature Accuracy ²	Package Description	Package Option	Branding
TMP06AKS-500RL7	500	-40°C to +150°C	±2°C	5-Lead SC-70	KS-5	T9A
TMP06AKS-REEL	10000	-40°C to +150°C	±2°C	5-Lead SC-70	KS-5	T9A
TMP06AKS-REEL7	3000	-40°C to +150°C	±2°C	5-Lead SC-70	KS-5	T9A
TMP06ART-500RL7	500	-40°C to +150°C	±2°C	5-Lead SOT-23 ³	RJ-5	T9A
TMP06ART-REEL	10000	-40°C to +150°C	±2°C	5-Lead SOT-23 ³	RJ-5	T9A
TMP06ART-REEL7	3000	-40°C to +150°C	±2°C	5-Lead SOT-23 ³	RJ-5	T9A
TMP06BKS-500RL7	500	-40°C to +150°C	±1°C	5-Lead SC-70	KS-5	T9B
TMP06BKS-REEL	10000	-40°C to +150°C	±1°C	5-Lead SC-70	KS-5	T9B
TMP06BKS-REEL7	3000	-40°C to +150°C	±1°C	5-Lead SC-70	KS-5	T9B
TMP06BRT-500RL7	500	-40°C to +150°C	±1°C	5-Lead SOT-23 ³	RJ-5	T9B
TMP06BRT-REEL	10000	-40°C to +150°C	±1°C	5-Lead SOT-23 ³	RJ-5	T9B
TMP06BRT-REEL7	3000	-40°C to +150°C	±1°C	5-Lead SOT-23 ³	RJ-5	T9B
TMP06AKSZ-500RL7 ⁴	500	-40°C to +150°C	±2°C	5-Lead SC-70	KS-5	T9C
TMP06AKSZ-REEL ⁴	10000	-40°C to +150°C	±2°C	5-Lead SC-70	KS-5	T9C
TMP06AKSZ-REEL7 ⁴	3000	-40°C to +150°C	±2°C	5-Lead SC-70	KS-5	T9C
TMP06ARTZ-500RL7 ⁴	500	-40°C to +150°C	±2°C	5-Lead SOT-23 ³	RJ-5	T9C
TMP06ARTZ-REEL ⁴	10000	-40°C to +150°C	±2°C	5-Lead SOT-23 ³	RJ-5	T9C
TMP06ARTZ-REEL7 ⁴	3000	-40°C to +150°C	±2°C	5-Lead SOT-23 ³	RJ-5	T9C
TMP06BKSZ-500RL7 ⁴	500	-40°C to +150°C	±1°C	5-Lead SC-70	KS-5	T9D
TMP06BKSZ-REEL ⁴	10000	-40°C to +150°C	±1°C	5-Lead SC-70	KS-5	T9D
TMP06BKSZ-REEL7 ⁴	3000	-40°C to +150°C	±1°C	5-Lead SC-70	KS-5	T9D
TMP06BRTZ-500RL7 ⁴	500	-40°C to +150°C	±1°C	5-Lead SOT-23 ³	RJ-5	T9D
TMP06BRTZ-REEL ⁴	10000	-40°C to +150°C	±1°C	5-Lead SOT-23 ³	RJ-5	T9D
TMP06BRTZ-REEL7 ⁴	3000	-40°C to +150°C	±1°C	5-Lead SOT-23 ³	RJ-5	T9D

¹ It is not recommended to operate the device at temperatures above 125°C for more than a total of 5% (5,000 hours) of the lifetime of the device. Any exposure beyond this limit affects device reliability.

² A-Grade temperature accuracy is over the 0°C to 70°C temperature range and B-Grade temperature accuracy is over the +25°C to 70°C temperature range.

³ Consult sales for availability.

⁴ Z = Pb-free part.

NOTES

NOTES