

FEATURES

Available in space-saving MSOP package
 Gain set with 1 external resistor (gain range 1 to 1000)
 Wide power supply range: ± 2.3 V to ± 18 V
 Temperature range for specified performance:
 -40°C to $+85^{\circ}\text{C}$

Operational up to 125°C^1

EXCELLENT AC SPECIFICATIONS

80 dB min CMRR to 10 kHz ($G = 1$)
 825 kHz -3 dB bandwidth ($G = 1$)
 2 V/ μs slew rate

LOW NOISE

8 nV/ $\sqrt{\text{Hz}}$, @ 1 kHz, max input voltage noise
 0.25 μV p-p input noise (0.1 Hz to 10 Hz)

HIGH ACCURACY DC PERFORMANCE (AD8221BR)

90 dB min CMRR ($G = 1$)
 25 μV max input offset voltage
 0.3 $\mu\text{V}/^{\circ}\text{C}$ max input offset drift
 0.4 nA max input bias current

APPLICATIONS

Weigh scales
 Industrial process controls
 Bridge amplifiers
 Precision data acquisition systems
 Medical instrumentation
 Strain gages
 Transducer interfaces

GENERAL DESCRIPTION

The AD8221 is a gain programmable, high performance instrumentation amplifier that delivers the industry's highest CMRR over frequency. The CMRR of instrumentation amplifiers on the market today falls off at 200 Hz. In contrast, the AD8221 maintains a minimum CMRR of 80 dB to 10 kHz for all grades at $G = 1$. High CMRR over frequency allows the AD8221 to reject wideband interference and line harmonics, greatly simplifying filter requirements. Possible applications include precision data acquisition, biomedical analysis, and aerospace instrumentation.

Low voltage offset, low offset drift, low gain drift, high gain accuracy, and high CMRR make this part an excellent choice in applications that demand the best dc performance possible, such as bridge signal conditioning.

Rev. A

Information furnished by Analog Devices is believed to be accurate and reliable. However, no responsibility is assumed by Analog Devices for its use, nor for any infringements of patents or other rights of third parties that may result from its use. Specifications subject to change without notice. No license is granted by implication or otherwise under any patent or patent rights of Analog Devices. Trademarks and registered trademarks are the property of their respective owners.

CONNECTION DIAGRAM

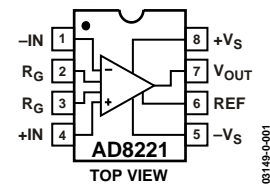

Figure 1. SOIC and MSOP Connection Diagram

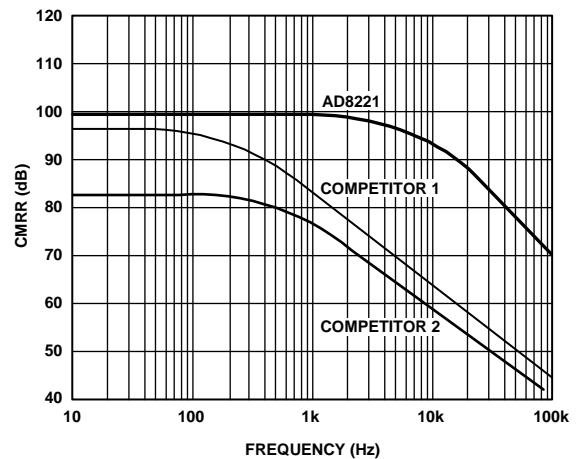

Figure 2. Typical CMRR vs. Frequency for $G = 1$

Programmable gain affords the user design flexibility. A single resistor sets the gain from 1 to 1000. The AD8221 operates on both single and dual supplies, and is well suited for applications where ± 10 V input voltages are encountered.

The AD8221 is available in low cost 8-lead SOIC and MSOP packages, both of which offer the industry's best performance. The MSOP requires half the board space of the SOIC, making it ideal for multichannel or space-constrained applications.

Performance is specified over the entire industrial temperature range of -40°C to $+85^{\circ}\text{C}$ for all grades. Furthermore, the AD8221 is operational from -40°C to $+125^{\circ}\text{C}^1$.

¹ See Typical Performance Curves for expected operation from 85°C to 125°C .

TABLE OF CONTENTS

| | | | |
|---|----|--|----|
| Specifications..... | 3 | Input Protection | 15 |
| Absolute Maximum Ratings..... | 5 | RF Interference | 16 |
| ESD Caution..... | 5 | Precision Strain Gage..... | 16 |
| Typical Performance Characteristics | 6 | Conditioning ± 10 V Signals for a +5 V Differential Input ADC | 17 |
| Theory of Operation | 13 | AC-Coupled Instrumentation Amplifier | 17 |
| Gain Selection | 14 | Outline Dimensions | 18 |
| Layout..... | 14 | Ordering Guide | 18 |
| Reference Terminal | 15 | | |
| Power Supply Regulation and Bypassing | 15 | | |
| Input Bias Current Return Path..... | 15 | | |

REVISION HISTORY

Revision A

11/03—Data Sheet Changed from Rev. 0 to Rev. A

| Change | Page |
|--|------|
| Changes to Features..... | 1 |
| Changes to Specifications section | 4 |
| Change to Theory of Operation section..... | 13 |
| Change to Gain Selection section..... | 14 |

SPECIFICATIONS

Table 1. $V_S = \pm 15\text{ V}$, $V_{REF} = 0\text{ V}$, $T_A = +25^\circ\text{C}$, $G = 1$, $R_L = 2\text{ k}\Omega$, unless otherwise noted

| Parameter | Conditions | AR Grade | | | BR Grade | | | ARM Grade | | | Unit |
|---|---|-----------|----------------|----------|-----------|----------------|----------|-----------|----------------|----------|------------------------------|
| | | Min | Typ | Max | Min | Typ | Max | Min | Typ | Max | |
| COMMON-MODE REJECTION RATIO (CMRR) | | | | | | | | | | | |
| CMRR DC to 60 Hz with 1 k Ω Source Imbalance | $V_{CM} = -10\text{ V to }+10\text{ V}$ | | | | | | | | | | |
| G = 1 | | 80 | | | 90 | | | 80 | | | dB |
| G = 10 | | 100 | | | 110 | | | 100 | | | dB |
| G = 100 | | 120 | | | 130 | | | 120 | | | dB |
| G = 1000 | | 130 | | | 140 | | | 130 | | | dB |
| CMRR at 10 kHz | $V_{CM} = -10\text{ V to }+10\text{ V}$ | | | | | | | | | | |
| G = 1 | | 80 | | | 80 | | | 80 | | | dB |
| G = 10 | | 90 | | | 100 | | | 90 | | | dB |
| G = 100 | | 100 | | | 110 | | | 100 | | | dB |
| G = 1000 | | 100 | | | 110 | | | 100 | | | dB |
| NOISE | $RTI\ noise = \sqrt{e_{NI}^2 + (e_{NO}/G)^2}$ | | | | | | | | | | |
| Voltage Noise, 1 kHz | | | | | | | | | | | |
| Input Voltage Noise, e_{NI} | $V_{IN+}, V_{IN-}, V_{REF} = 0$ | | | 8 | | | 8 | | | 8 | nV/ $\sqrt{\text{Hz}}$ |
| Output Voltage Noise, e_{NO} | | | | 75 | | | 75 | | | 75 | nV/ $\sqrt{\text{Hz}}$ |
| RTI | $f = 0.1\text{ Hz to }10\text{ Hz}$ | | | | | | | | | | |
| G = 1 | | | 2 | | | 2 | | | 2 | | $\mu\text{V p-p}$ |
| G = 10 | | | 0.5 | | | 0.5 | | | 0.5 | | $\mu\text{V p-p}$ |
| G = 100 to 1000 | | | 0.25 | | | 0.25 | | | 0.25 | | $\mu\text{V p-p}$ |
| Current Noise | $f = 1\text{ kHz}$ | | | 40 | | | 40 | | | 40 | fA/ $\sqrt{\text{Hz}}$ |
| | $f = 0.1\text{ Hz to }10\text{ Hz}$ | | | 6 | | | 6 | | | 6 | pA p-p |
| VOLTAGE OFFSET ¹ | | | | | | | | | | | |
| Input Offset, V_{OSI} | $V_S = \pm 5\text{ V to } \pm 15\text{ V}$ | | | 60 | | | 25 | | | 70 | μV |
| Over Temperature | $T = -40^\circ\text{C to }+85^\circ\text{C}$ | | | 86 | | | 45 | | | 135 | μV |
| Average TC | | | | 0.4 | | | 0.3 | | | 0.9 | $\mu\text{V}/^\circ\text{C}$ |
| Output Offset, V_{OSO} | $V_S = \pm 5\text{ V to } \pm 15\text{ V}$ | | | 300 | | | 200 | | | 600 | μV |
| Over Temperature | $T = -40^\circ\text{C to }+85^\circ\text{C}$ | | | 0.66 | | | 0.45 | | | 1.00 | mV |
| Average TC | | | | 6 | | | 5 | | | 9 | $\mu\text{V}/^\circ\text{C}$ |
| Offset RTI vs. Supply (PSR) | $V_S = \pm 2.3\text{ V to } \pm 18\text{ V}$ | | | | | | | | | | |
| G = 1 | | 90 | 110 | | 94 | 110 | | 90 | 100 | | dB |
| G = 10 | | 110 | 120 | | 114 | 130 | | 100 | 120 | | dB |
| G = 100 | | 124 | 130 | | 130 | 140 | | 120 | 140 | | dB |
| G = 1000 | | 130 | 140 | | 140 | 150 | | 120 | 140 | | dB |
| INPUT CURRENT | | | | | | | | | | | |
| Input Bias Current | | | 0.5 | 1.5 | | 0.2 | 0.4 | | 0.5 | 2 | nA |
| Over Temperature | $T = -40^\circ\text{C to }+85^\circ\text{C}$ | | | 2.0 | | | 1 | | | 3 | nA |
| Average TC | | | 1 | | | 1 | | | 3 | | pA/ $^\circ\text{C}$ |
| Input Offset Current | | | 0.2 | 0.6 | | 0.1 | 0.4 | | 0.3 | 1 | nA |
| Over Temperature | $T = -40^\circ\text{C to }+85^\circ\text{C}$ | | | 0.8 | | | 0.6 | | | 1.5 | nA |
| Average TC | | | 1 | | | 1 | | | 3 | | pA/ $^\circ\text{C}$ |
| REFERENCE INPUT | | | | | | | | | | | |
| R_{IN} | | | 20 | | | 20 | | | 20 | | k Ω |
| I_{IN} | $V_{IN+}, V_{IN-}, V_{REF} = 0$ | | 50 | 60 | | 50 | 60 | | 50 | 60 | μA |
| Voltage Range | | $-V_S$ | | $+V_S$ | | $-V_S$ | | $+V_S$ | $-V_S$ | | $+V_S$ |
| Gain to Output | | | 1 ± 0.0001 | | | 1 ± 0.0001 | | | 1 ± 0.0001 | | V/V |
| POWER SUPPLY | | | | | | | | | | | |
| Operating Range | $V_S = \pm 2.3\text{ V to } \pm 18\text{ V}$ | ± 2.3 | | ± 18 | ± 2.3 | | ± 18 | ± 2.3 | | ± 18 | V |
| Quiescent Current | | | 0.9 | 1 | | 0.9 | 1 | | 0.9 | 1 | mA |
| Over Temperature | $T = -40^\circ\text{C to }+85^\circ\text{C}$ | | 1 | 1.2 | | 1 | 1.2 | | 1 | 1.2 | mA |

AD8221

| Parameter | Conditions | AR Grade | | | BR Grade | | | ARM Grade | | | Unit |
|--|---|--------------|--------|--------------|--------------|--------|--------------|--------------|--------|--------------|----------------------|
| | | Min | Typ | Max | Min | Typ | Max | Min | Typ | Max | |
| DYNAMIC RESPONSE | | | | | | | | | | | |
| Small Signal -3 dB Bandwidth | | | | | | | | | | | |
| G = 1 | | | 825 | | | 825 | | | 825 | | kHz |
| G = 10 | | | 562 | | | 562 | | | 562 | | kHz |
| G = 100 | | | 100 | | | 100 | | | 100 | | kHz |
| G = 1000 | | | 14.7 | | | 14.7 | | | 14.7 | | kHz |
| Settling Time 0.01% | 10 V Step | | | | | | | | | | |
| G = 1 to 100 | | | 10 | | | 10 | | | 10 | | μs |
| G = 1000 | | | 80 | | | 80 | | | 80 | | μs |
| Settling Time 0.001% | 10 V Step | | | | | | | | | | |
| G = 1 to 100 | | | 13 | | | 13 | | | 13 | | μs |
| G = 1000 | | | 110 | | | 110 | | | 110 | | μs |
| Slew Rate | G = 1 | 1.5 | 2 | | 1.5 | 2 | | 1.5 | 2 | | V/μs |
| | G = 5-100 | 2 | 2.5 | | 2 | 2.5 | | 2 | 2.5 | | V/μs |
| GAIN | | | | | | | | | | | |
| Gain Range | $G = 1 + (49.4 \text{ k}\Omega/R_G)$ | 1 | | 1000 | 1 | | 1000 | 1 | | 1000 | V/V |
| Gain Error | $V_{OUT} \pm 10 \text{ V}$ | | | | | | | | | | |
| G = 1 | | | | 0.03 | | | | | 0.1 | | % |
| G = 10 | | | | 0.3 | | | | | 0.3 | | % |
| G = 100 | | | | 0.3 | | | | | 0.3 | | % |
| G = 1000 | | | | 0.3 | | | | | 0.3 | | % |
| Gain Nonlinearity | $V_{OUT} = -10 \text{ V to } +10 \text{ V}$ | | | | | | | | | | |
| G = 1 to 10 | $R_L = 10 \text{ k}\Omega$ | | 3 | 10 | | 3 | 10 | | 5 | 15 | ppm |
| G = 100 | $R_L = 10 \text{ k}\Omega$ | | 5 | 15 | | 5 | 15 | | 7 | 20 | ppm |
| G = 1000 | $R_L = 10 \text{ k}\Omega$ | | 10 | 40 | | 10 | 40 | | 10 | 50 | ppm |
| G = 1 to 100 | $R_L = 2 \text{ k}\Omega$ | | 10 | 95 | | 10 | 95 | | 15 | 100 | ppm |
| Gain vs. Temperature | | | | | | | | | | | |
| G = 1 | | | 3 | 10 | | 2 | 5 | | 3 | 10 | ppm/°C |
| $G > 1^2$ | | | | -50 | | | -50 | | | -50 | ppm/°C |
| INPUT | | | | | | | | | | | |
| Input Impedance | | | | | | | | | | | |
| Differential | | | 100 2 | | | 100 2 | | | 100 2 | | $G\Omega \text{pF}$ |
| Common Mode | | | 100 2 | | | 100 2 | | | 100 2 | | $G\Omega \text{pF}$ |
| Input Operating Voltage Range ³ | $V_S = \pm 2.3 \text{ V to } \pm 5 \text{ V}$ | $-V_S + 1.9$ | | $+V_S - 1.1$ | $-V_S + 1.9$ | | $+V_S - 1.1$ | $-V_S + 1.9$ | | $+V_S - 1.1$ | V |
| Over Temperature | $T = -40^\circ\text{C to } +85^\circ\text{C}$ | $-V_S + 2.0$ | | $+V_S - 1.2$ | $-V_S + 2.0$ | | $+V_S - 1.2$ | $-V_S + 2.0$ | | $+V_S - 1.2$ | V |
| Input Operating Voltage Range | $V_S = \pm 5 \text{ V to } \pm 18 \text{ V}$ | $-V_S + 1.9$ | | $+V_S - 1.2$ | $-V_S + 1.9$ | | $+V_S - 1.2$ | $-V_S + 1.9$ | | $+V_S - 1.2$ | V |
| Over Temperature | $T = -40^\circ\text{C to } +85^\circ\text{C}$ | $-V_S + 2.0$ | | $+V_S - 1.2$ | $-V_S + 2.0$ | | $+V_S - 1.2$ | $-V_S + 2.0$ | | $+V_S - 1.2$ | V |
| OUTPUT | | | | | | | | | | | |
| Output Swing | $R_L = 10 \text{ k}\Omega$ | | | | | | | | | | |
| Over Temperature | $V_S = \pm 2.3 \text{ V to } \pm 5 \text{ V}$ | $-V_S + 1.1$ | | $+V_S - 1.2$ | $-V_S + 1.1$ | | $+V_S - 1.2$ | $-V_S + 1.1$ | | $+V_S - 1.2$ | V |
| Over Temperature | $T = -40^\circ\text{C to } +85^\circ\text{C}$ | $-V_S + 1.4$ | | $+V_S - 1.3$ | $-V_S + 1.4$ | | $+V_S - 1.3$ | $-V_S + 1.4$ | | $+V_S - 1.3$ | V |
| Output Swing | $V_S = \pm 5 \text{ V to } \pm 18 \text{ V}$ | $-V_S + 1.2$ | | $+V_S - 1.4$ | $-V_S + 1.2$ | | $+V_S - 1.4$ | $-V_S + 1.2$ | | $+V_S - 1.4$ | V |
| Over Temperature | $T = -40^\circ\text{C to } +85^\circ\text{C}$ | $-V_S + 1.6$ | | $+V_S - 1.5$ | $-V_S + 1.6$ | | $+V_S - 1.5$ | $-V_S + 1.6$ | | $+V_S - 1.5$ | V |
| Short-Circuit Current | | | 18 | | | 18 | | | 18 | | mA |
| TEMPERATURE RANGE | | | | | | | | | | | |
| Specified Performance | | -40 | | +85 | -40 | | +85 | -40 | | +85 | °C |
| Operational ⁴ | | -40 | | +125 | -40 | | +125 | -40 | | +125 | °C |

¹ Total RTI $V_{OS} = (V_{OSI}) + (V_{OSO}/G)$.

² Does not include the effects of external resistor R_G .

³ One input grounded. $G = 1$.

⁴ See Typical Performance Curves for expected operation between 85°C to 125°C.

ABSOLUTE MAXIMUM RATINGS

Table 2. AD8221 Absolute Maximum Ratings

| Parameter | Rating |
|--------------------------------|---|
| Supply Voltage | ± 18 V |
| Internal Power Dissipation | 200 mW |
| Output Short Circuit Current | Indefinite |
| Input Voltage (Common-Mode) | $\pm V_s$ |
| Differential Input Voltage | $\pm V_s$ |
| Storage Temperature | -65°C to $+150^{\circ}\text{C}$ |
| Operational* Temperature Range | -40°C to $+125^{\circ}\text{C}$ |

*Temperature range for specified performance is -40°C to $+85^{\circ}\text{C}$. See Typical Performance Curves for expected operation from $+85^{\circ}\text{C}$ to $+125^{\circ}\text{C}$.

Stresses above those listed under Absolute Maximum Ratings may cause permanent damage to the device. This is a stress rating only; functional operation of the device at these or any other conditions above those indicated in the operational section of this specification is not implied. Exposure to absolute maximum rating conditions may affect device reliability.

Specification is for device in free air:

SOIC θ_{JA} (4 Layer JEDEC Board) = $121^{\circ}\text{C}/\text{W}$.

MSOP θ_{JA} (4 Layer JEDEC Board) = $135^{\circ}\text{C}/\text{W}$.

ESD CAUTION

ESD (electrostatic discharge) sensitive device. Electrostatic charges as high as 4000 V readily accumulate on the human body and test equipment and can discharge without detection. Although this product features proprietary ESD protection circuitry, permanent damage may occur on devices subjected to high energy electrostatic discharges. Therefore, proper ESD precautions are recommended to avoid performance degradation or loss of functionality.



TYPICAL PERFORMANCE CHARACTERISTICS

(@+25°C, $V_S = \pm 15\text{ V}$, $R_L = 10\text{ k}\Omega$, unless otherwise noted.)

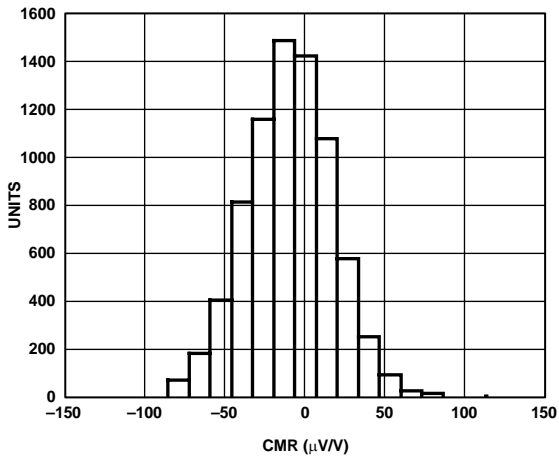

Figure 3. Typical Distribution for CMR ($G = 1$)

03149-0-003

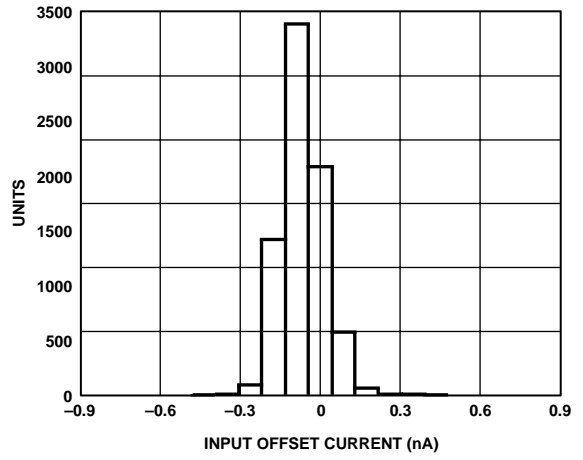

Figure 6. Typical Distribution of Input Offset Current

03149-0-006

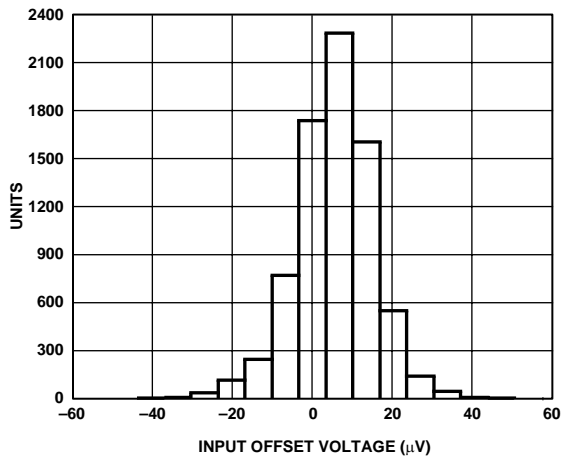

Figure 4. Typical Distribution of Input Offset Voltage

03149-0-004

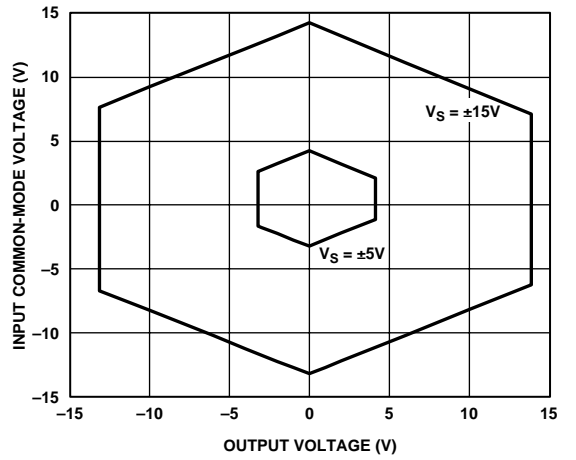

Figure 7. Input Common-Mode Range vs. Output Voltage, $G = 1$

03149-0-007

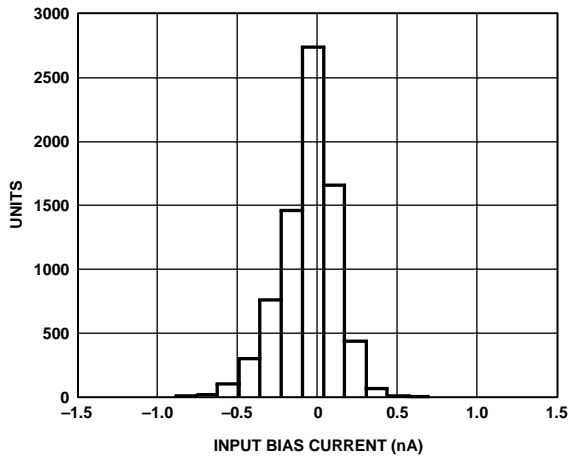

Figure 5. Typical Distribution of Input Bias Current

03149-0-005

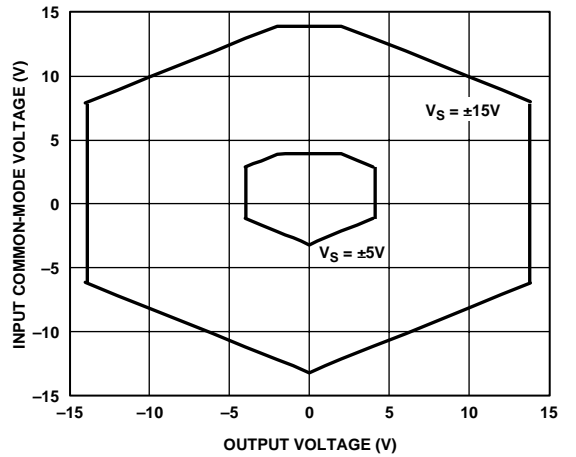

Figure 8. Input Common-Mode Range vs. Output Voltage, $G = 100$

03149-0-008

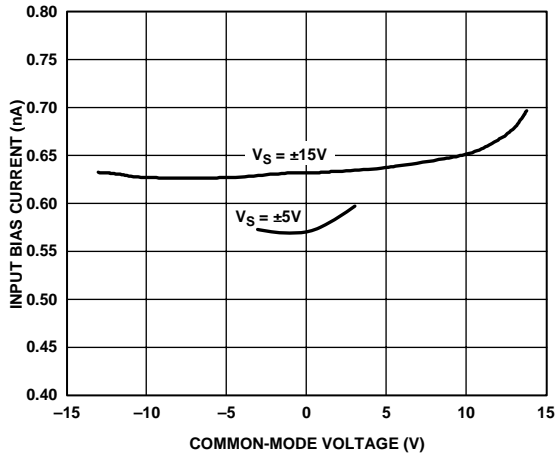

Figure 9. I_{BIAS} vs. CMV

03149-0-009

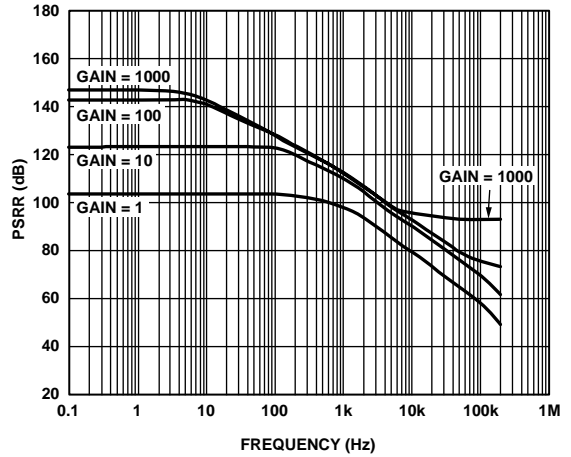

Figure 12. Positive PSRR vs. Frequency, RTI ($G = 1$ to 1000)

03149-0-012

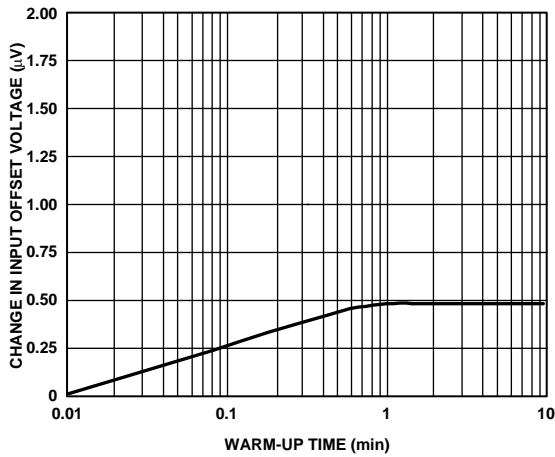

Figure 10. Change in Input Offset Voltage vs. Warm-Up Time

03149-0-010

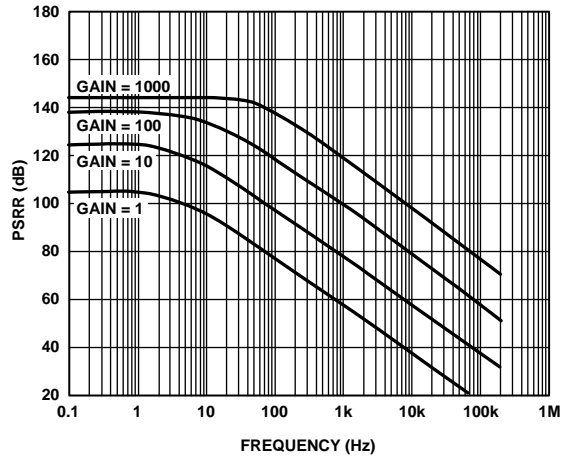

Figure 13. Negative PSRR vs. Frequency, RTI ($G = 1$ to 1000)

03149-0-013

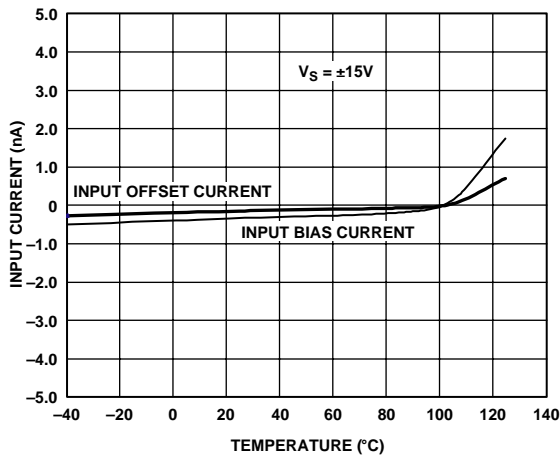

Figure 11. Input Bias Current and Offset Current vs. Temperature

03149-0-011

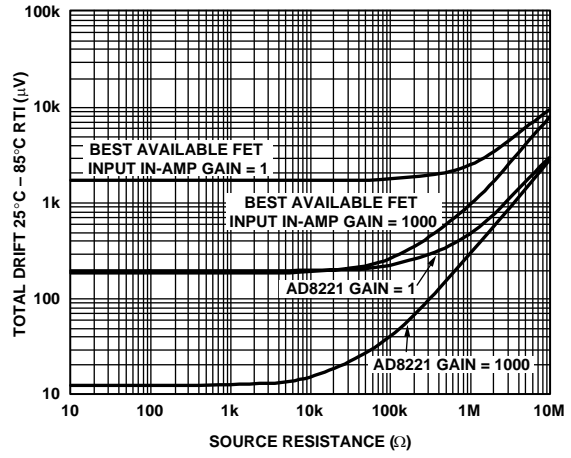

Figure 14. Total Drift vs. Source Resistance

03149-0-014

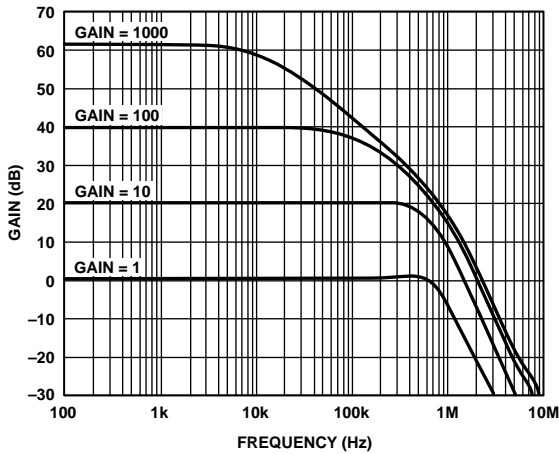

Figure 15. Gain vs. Frequency

03149-0-015

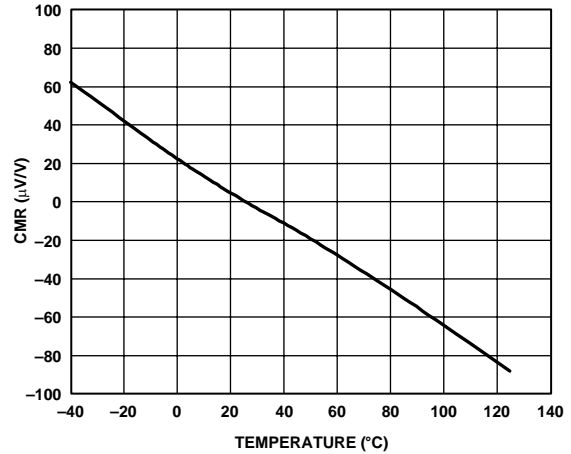

Figure 18. CMR vs. Temperature

03149-0-041

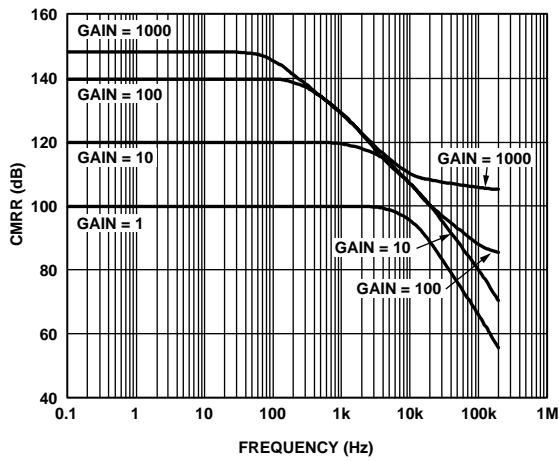

Figure 16. CMRR vs. Frequency, RTI

03149-0-016

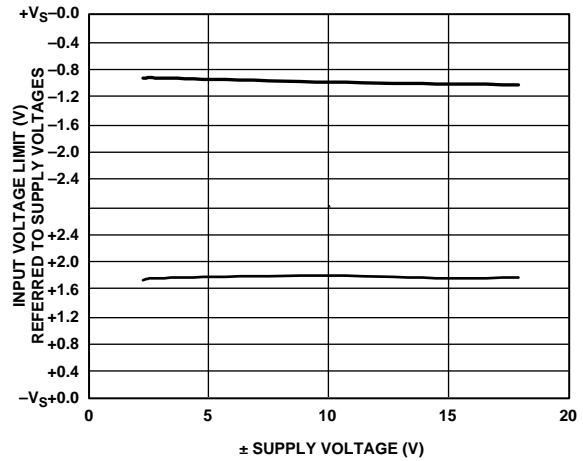

Figure 19. Input Voltage Limit vs. Supply Voltage, $G = 1$

03149-0-018

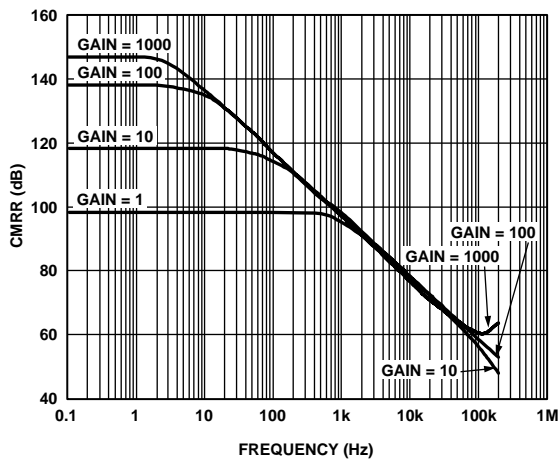

Figure 17. CMRR vs. Frequency, RTI, 1 kΩ Source Imbalance

03149-0-017

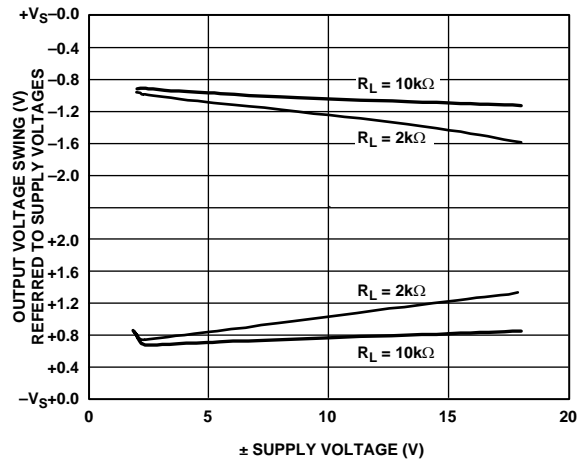

Figure 20. Output Voltage Swing vs. Supply Voltage, $G = 1$

03149-0-019

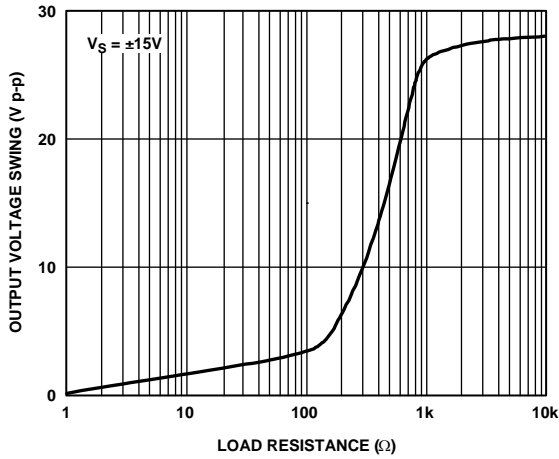

Figure 21. Output Voltage Swing vs. Load Resistance

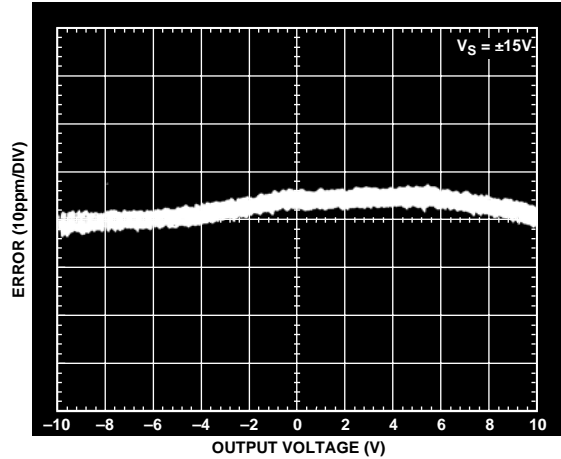

Figure 24. Gain Nonlinearity, $G = 100$, $R_L = 10\text{ k}\Omega$

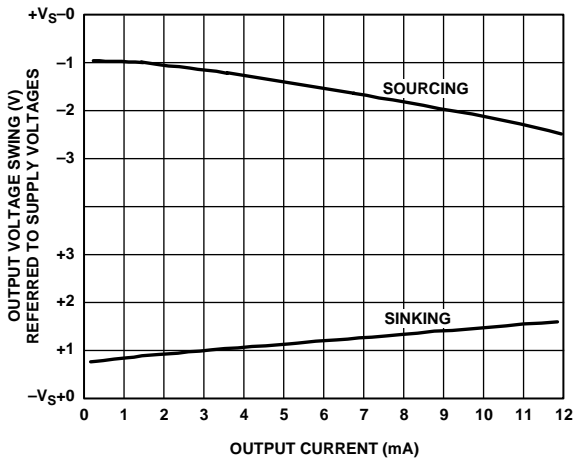

Figure 22. Output Voltage Swing vs. Output Current, $G = 1$

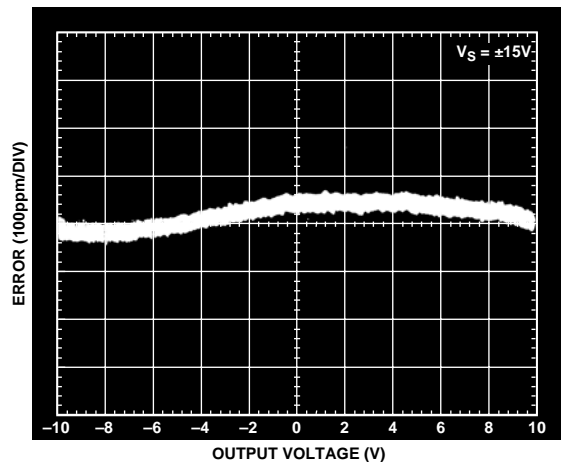

Figure 25. Gain Nonlinearity, $G = 1000$, $R_L = 10\text{ k}\Omega$

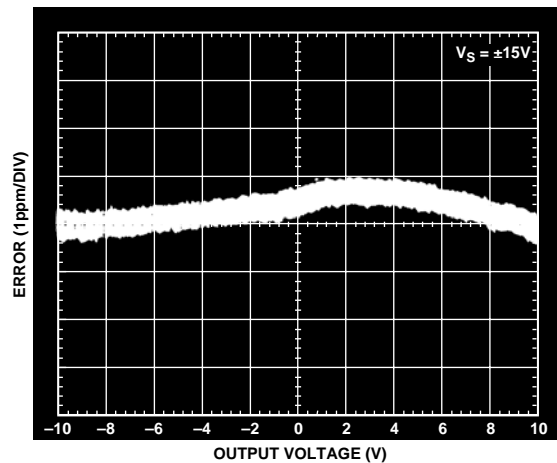

Figure 23. Gain Nonlinearity, $G = 1$, $R_L = 10\text{ k}\Omega$

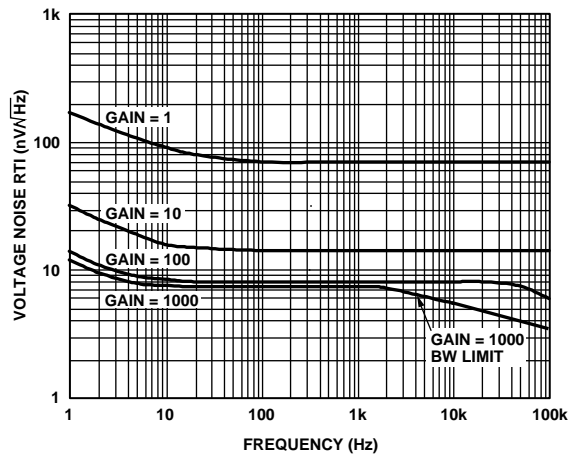

Figure 26. Voltage Noise Spectral Density vs. Frequency ($G = 1$ to 1000)

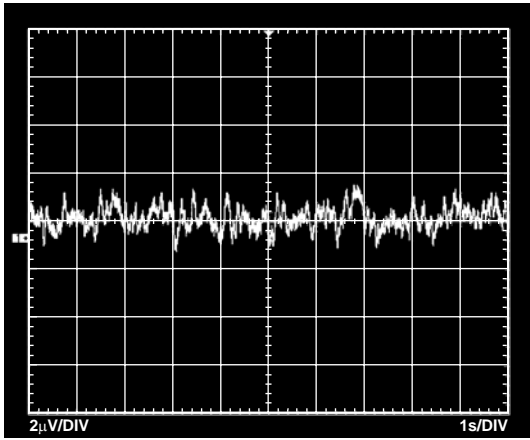

Figure 27. 0.1 Hz to 10 Hz RTI Voltage Noise (G = 1)

03149-0-026

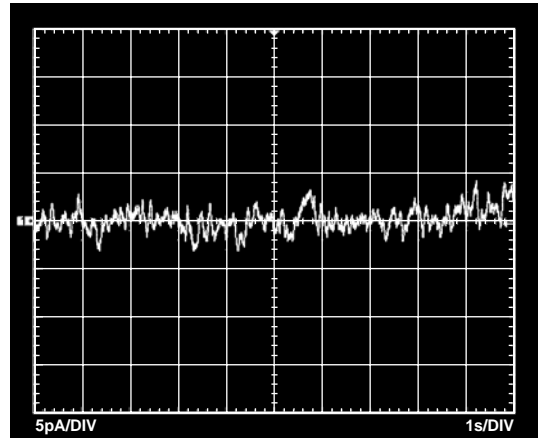

Figure 30. 0.1 Hz to 10 Hz Current Noise

03149-0-029

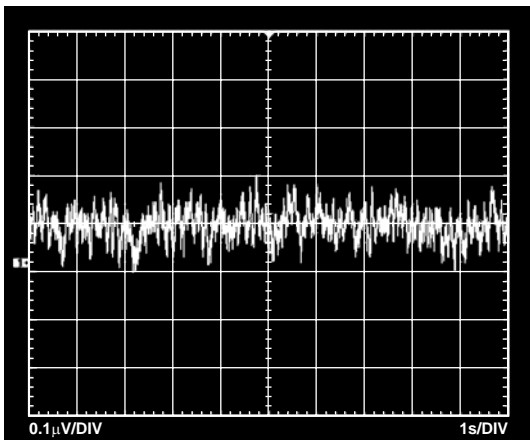

Figure 28. 0.1 Hz to 10 Hz RTI Voltage Noise (G = 1000)

03149-0-027

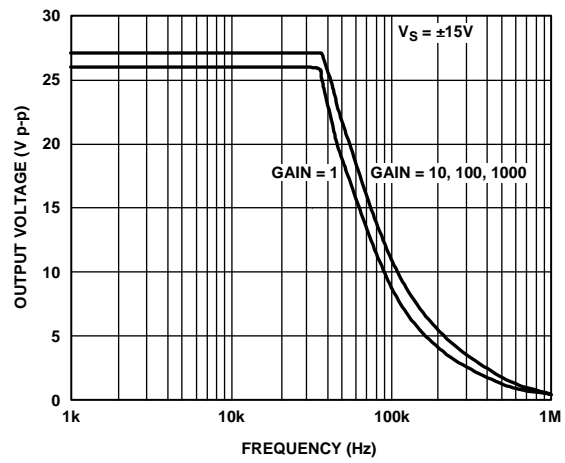

Figure 31. Large Signal Frequency Response

03149-0-030

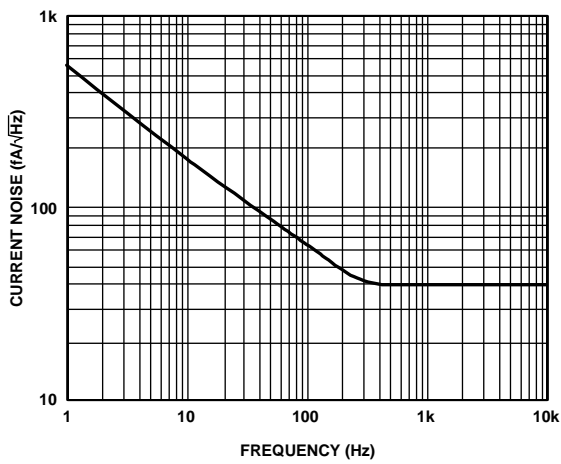

Figure 29. Current Noise Spectral Density vs. Frequency

03149-0-028

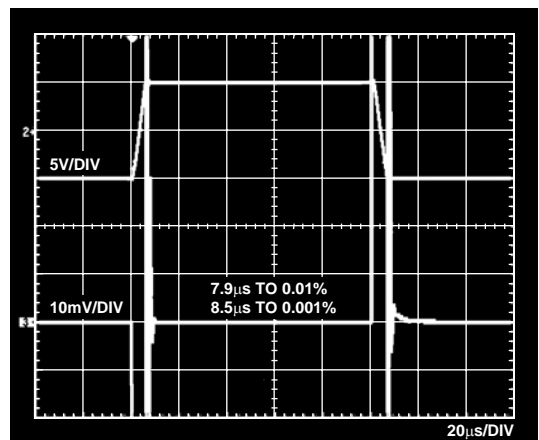

Figure 32. Large Signal Pulse Response and Settling Time (G = 1), 0.002%/div

03149-0-031

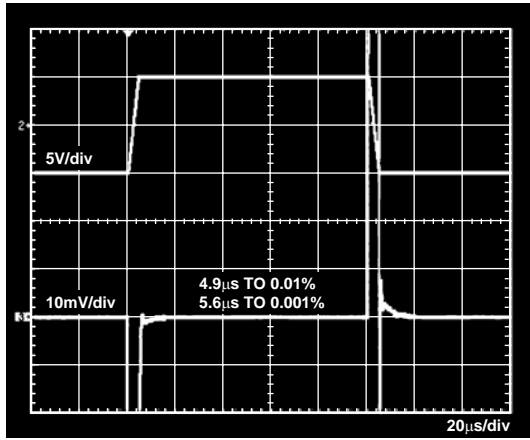

Figure 33. Large Signal Pulse Response and Settling Time ($G = 10$), 0.002%/div

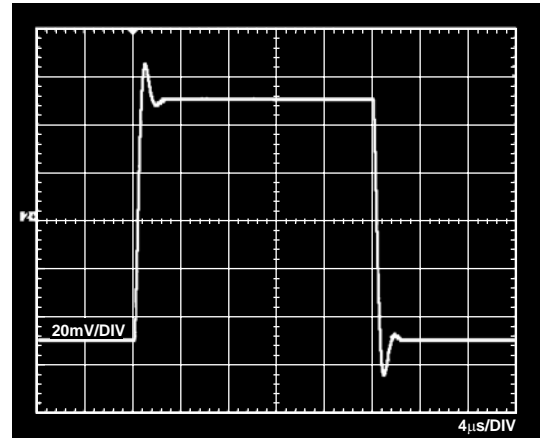

Figure 36. Small Signal Response, $G = 1$, $R_L = 2\text{ k}\Omega$, $C_L = 100\text{ pF}$

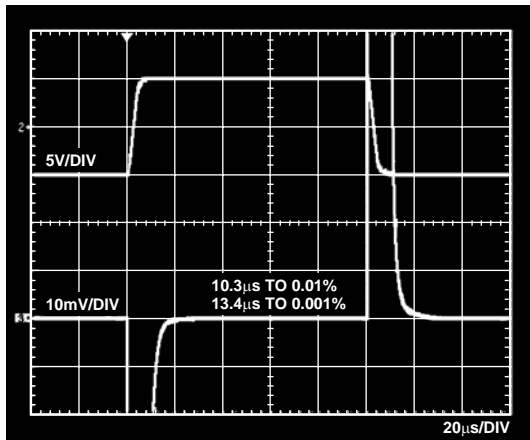

Figure 34. Large Signal Pulse Response and Settling Time ($G = 100$), 0.002%/div

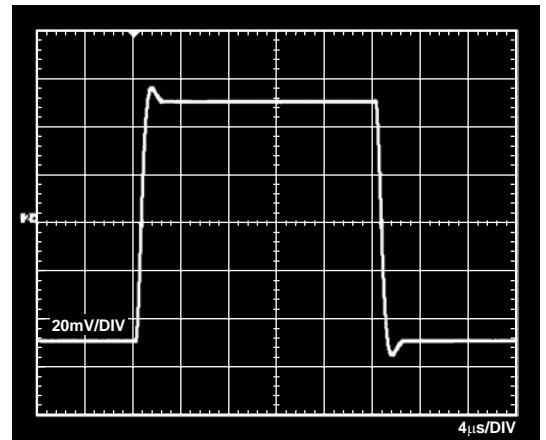

Figure 37. Small Signal Response, $G = 10$, $R_L = 2\text{ k}\Omega$, $C_L = 100\text{ pF}$

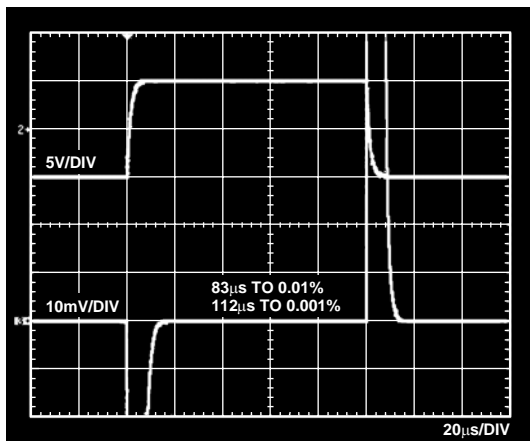

Figure 35. Large Signal Pulse Response and Settling Time ($G = 1000$), 0.002%/div

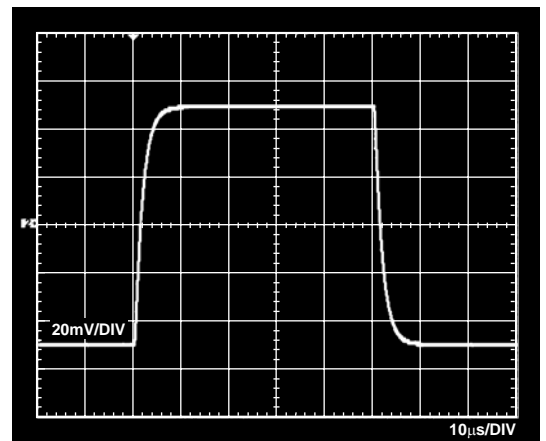

Figure 38. Small Signal Response, $G = 100$, $R_L = 2\text{ k}\Omega$, $C_L = 100\text{ pF}$

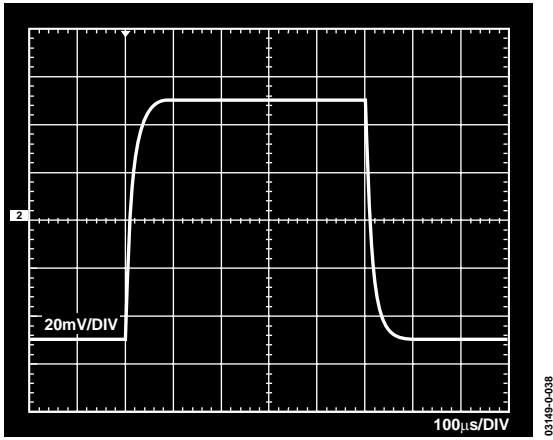

Figure 39. Small Signal Response, $G = 1000$, $R_L = 2 \text{ k}\Omega$, $C_L = 100 \text{ pF}$

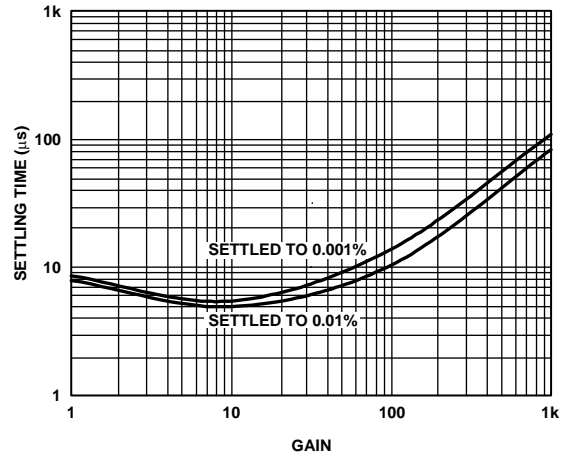

Figure 41. Settling Time vs. Gain for a 10 V Step

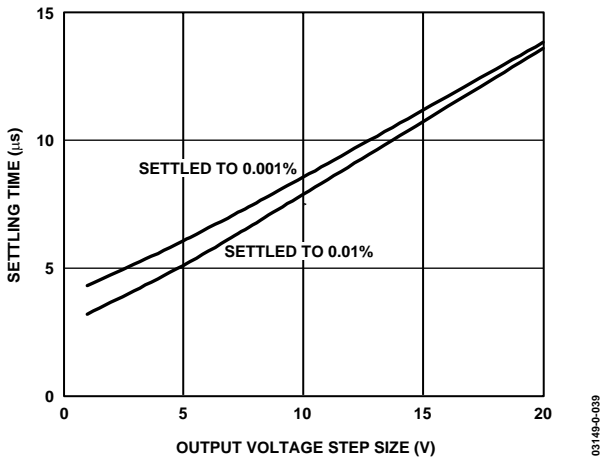

Figure 40. Settling Time vs. Step Size ($G = 1$)

03149-0-038

03149-0-040

03149-0-039

THEORY OF OPERATION

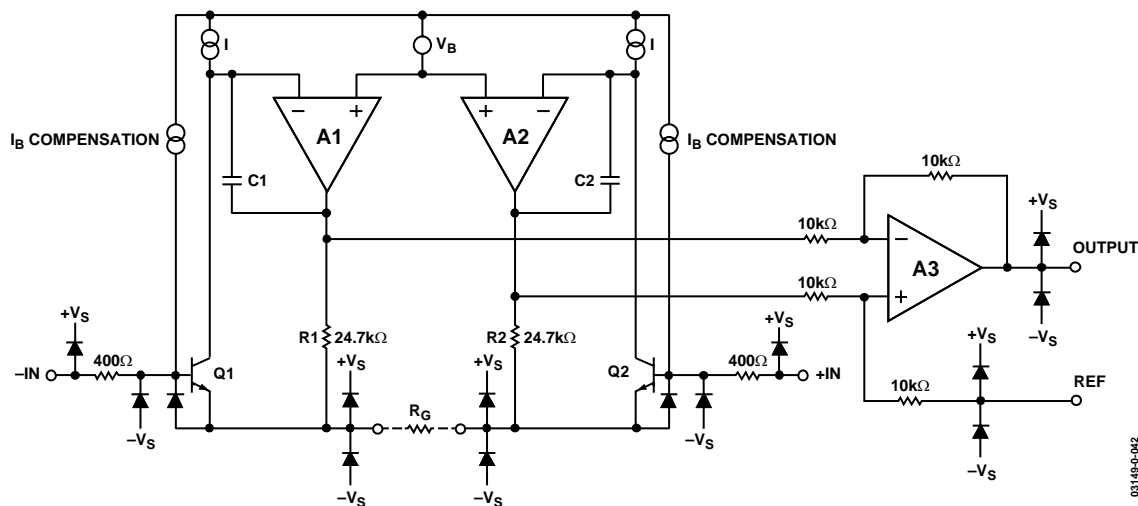

Figure 42. Simplified Schematic

The AD8221 is a monolithic instrumentation amplifier based on the classic 3-op amp topology. Input transistors Q1 and Q2 are biased at a fixed current, so that any differential input signal will force the output voltages of A1 and A2 to change accordingly. A signal applied to the input creates a current through R_G , R1, and R2, such that the outputs of A1 and A2 deliver the correct voltage. Topologically, Q1, A1, R1 and Q2, A2, R2 can be viewed as precision current feedback amplifiers. The amplified differential and common-mode signals are applied to a difference amplifier that rejects the common-mode voltage but amplifies the differential voltage. The difference amplifier employs innovations that result in low output offset voltage as well as low output offset voltage drift. Laser-trimmed resistors allow for a highly accurate in-amp with gain error typically less than 20 ppm and CMRR that exceeds 90 dB ($G = 1$).

Using superbeta input transistors and an I_B compensation scheme, the AD8221 offers extremely high input impedance, low I_B , low I_B drift, low I_{OS} , low input bias current noise, and extremely low voltage noise of $8 \text{ nV}/\sqrt{\text{Hz}}$.

The transfer function of the AD8221 is

$$G = 1 + \frac{49.4\text{k}\Omega}{R_G}$$

Users can easily and accurately set the gain using a single, standard resistor.

Since the input amplifiers employ a current feedback architecture, the AD8221's gain-bandwidth product increases with gain, resulting in a system that does not suffer from the expected bandwidth loss of voltage feedback architectures at higher gains.

In order to maintain precision even at low input levels, special attention was given to the AD8221's design and layout, resulting in an in-amp whose performance satisfies the most demanding applications.

A unique pinout enables the AD8221 to meet a CMRR specification of 80 dB at 10 kHz ($G = 1$) and 110 dB at 1 kHz ($G = 1000$). The balanced pinout, shown in Figure 43, reduces the parasitics that had, in the past, adversely affected CMRR performance. In addition, the new pinout simplifies board layout because associated traces are grouped together. For example, the gain setting resistor pins are adjacent to the inputs, and the reference pin is next to the output.

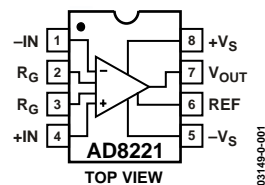

Figure 43. Pinout Diagram

AD8221

GAIN SELECTION

Placing a resistor across the R_G terminals will set the AD8221's gain, which may be calculated by referring to Table 3 or by using the gain equation

$$R_G = \frac{49.4k\Omega}{G-1}$$

Table 3. Gains Achieved Using 1% Resistors

| 1% Std Table Value of R_G (Ω) | Calculated Gain |
|--|-----------------|
| 49.9 k | 1.990 |
| 12.4 k | 4.984 |
| 5.49 k | 9.998 |
| 2.61 k | 19.93 |
| 1.00 k | 50.40 |
| 499 | 100.0 |
| 249 | 199.4 |
| 100 | 495.0 |
| 49.9 | 991.0 |

The AD8221 defaults to $G = 1$ when no gain resistor is used. Gain accuracy is determined by the absolute tolerance of R_G . The TC of the external gain resistor will increase the gain drift of the instrumentation amplifier. Gain error and gain drift are kept to a minimum when the gain resistor is not used.

LAYOUT

Careful board layout maximizes system performance. Traces from the gain setting resistor to the R_G pins should be kept as short as possible to minimize parasitic inductance. To ensure the most accurate output, the trace from the REF pin should either be connected to the AD8221's local ground as shown in Figure 47, or connected to a voltage that is referenced to the AD8221's local ground.

Common-Mode Rejection

One benefit of the AD8221's high CMRR over frequency is that it has greater immunity to disturbances such as line noise and its associated harmonics than do typical in-amps. These, typically, have CMRR fall-off at 200 Hz; common-mode filters are often used to compensate for this shortcoming. The AD8221 is able to reject CMRR over a greater frequency range, reducing the need for filtering.

A well implemented layout helps to maintain the AD8221's high CMRR over frequency. Input source impedance and capacitance should be closely matched. In addition, source resistance and capacitance should be placed as close to the inputs as permissible.

Grounding

The AD8221's output voltage is developed with respect to the potential on the reference terminal. Care should be taken to tie REF to the appropriate "local ground."

In mixed-signal environments, low level analog signals need to be isolated from the noisy digital environment. Many ADCs have separate analog and digital ground pins. Although it is convenient to tie both grounds to a single ground plane, the current traveling through the ground wires and PC board may cause hundreds of millivolts of error. Therefore, separate analog and digital ground returns should be used to minimize the current flow from sensitive points to the system ground. An example layout is shown in Figure 44 and Figure 45.

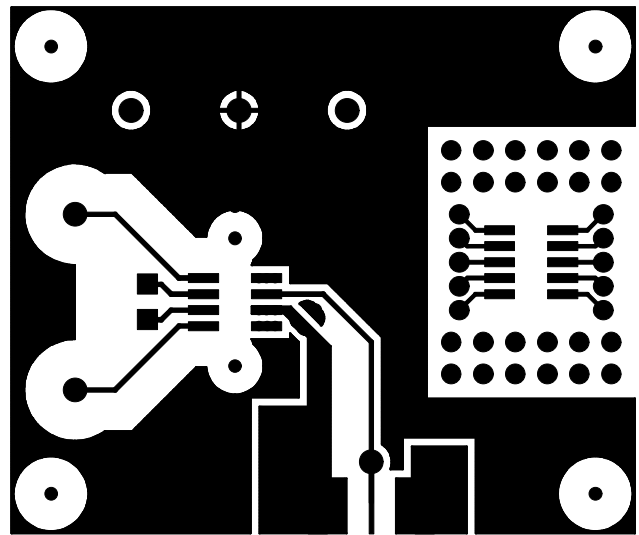

Figure 44. Top Layer of the AD8221-EVAL

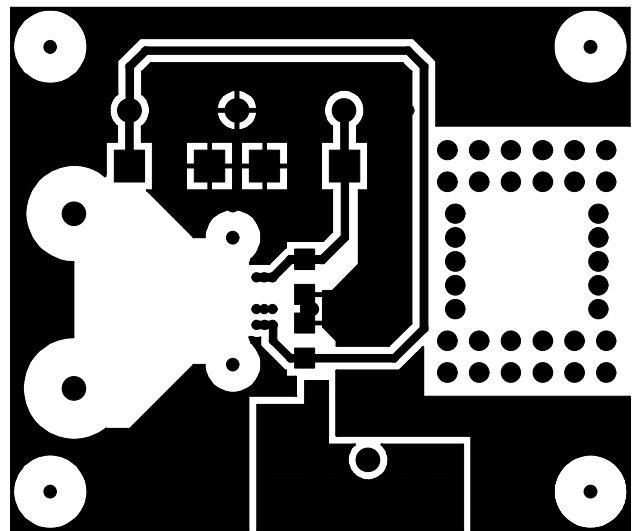

Figure 45. Bottom Layer of the AD8221-EVAL

REFERENCE TERMINAL

As shown in Figure 42, the reference terminal, REF, is at one end of a 10 k Ω resistor. The instrumentation amplifier's output is referenced to the voltage on the REF terminal; this is useful when the output signal needs to be offset to a precise midsupply level. For example, a voltage source can be tied to the REF pin to level-shift the output so that the AD8221 can interface with an ADC. The allowable reference voltage range is a function of the gain, input and supply voltage. The REF pin should not exceed either +V_S or -V_S by more than 0.5 V.

For best performance, source impedance to the REF terminal should be kept low, since parasitic resistance can adversely affect CMRR and gain accuracy.

POWER SUPPLY REGULATION AND BYPASSING

A stable dc voltage should be used to power the instrumentation amplifier. Noise on the supply pins may adversely affect performance. Bypass capacitors should be used to decouple the amplifier.

A 0.1 μ F capacitor should be placed close to each supply pin. As shown in Figure 47, a 10 μ F tantalum capacitor may be used further away from the part. In most cases, it may be shared by other precision integrated circuits.

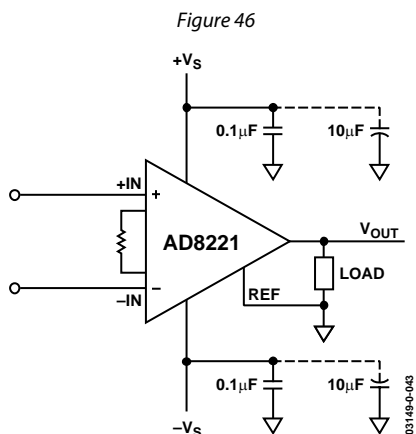

Figure 47. Supply Decoupling, REF and Output Referred to Local Ground

INPUT BIAS CURRENT RETURN PATH

The AD8221's input bias current must have a return path to common. When the source, such as a thermocouple, cannot provide a return current path, one should be created, as shown in Figure 48.

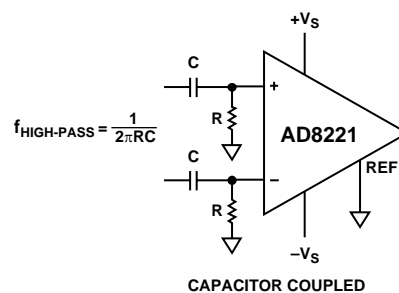
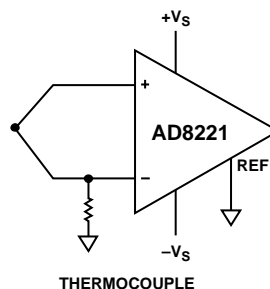
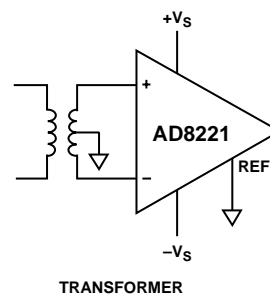

Figure 48. Creating an I_{BIAS} Path

INPUT PROTECTION

All terminals of the AD8221 are protected against ESD¹. In addition, the input structure allows for dc overload conditions below the negative supply, -V_S. The internal 400 Ω resistors limit current in the event of a negative fault condition. However, in the case of a dc overload voltage above the positive supply, +V_S, a large current would flow directly through the ESD diode to the positive rail. Therefore, an external resistor should be used in series with the input to limit current for voltages above +V_S. In either scenario, the AD8221 can safely handle a continuous 6 mA current, $I = V_{IN}/R_{EXT}$ for positive overvoltage and $I = V_{IN}/(400 \Omega + R_{EXT})$ for negative overvoltage.

For applications where the AD8221 encounters extreme overload voltages, as in cardiac defibrillators, external series resistors and low leakage diode clamps such as BAV199Ls, FJH1100s, or SP720s should be used.

¹ 1 kV—Human Body Model.

RF INTERFERENCE

RF rectification is often a problem when amplifiers are used in applications where there are strong RF signals. The disturbance may appear as a small dc offset voltage. High frequency signals can be filtered with a low-pass R-C network placed at the input of the instrumentation amplifier, as shown in Figure 49. The filter limits the input signal bandwidth according to the following relationship:

$$FilterFreq_{Diff} = \frac{1}{2\pi R(2C_D + C_C)}$$

$$FilterFreq_{CM} = \frac{1}{2\pi RC_C}$$

where $C_D \geq 10C_C$.

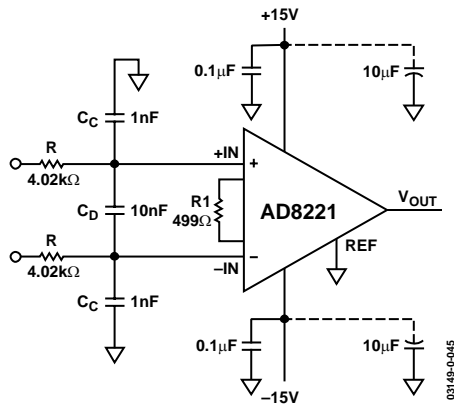

Figure 49. RFI Suppression

C_D affects the difference signal and C_C affects the common-mode signal. Values of R and C_C should be chosen to minimize RFI. Mismatch between the $R \times C_C$ at the positive input and the $R \times C_C$ at negative input will degrade the AD8221's CMRR. By using a value of C_D one magnitude larger than C_C , the effect of the mismatch is reduced, and hence, performance is improved.

PRECISION STRAIN GAGE

The AD8221's low offset and high CMRR over frequency make it an excellent candidate for bridge measurements. As shown in Figure 50, the bridge can be directly connected to the inputs of the amplifier.

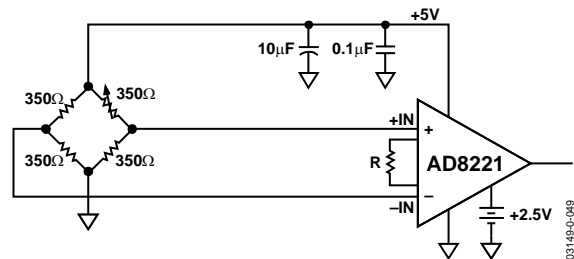

Figure 50. Precision Strain Gage

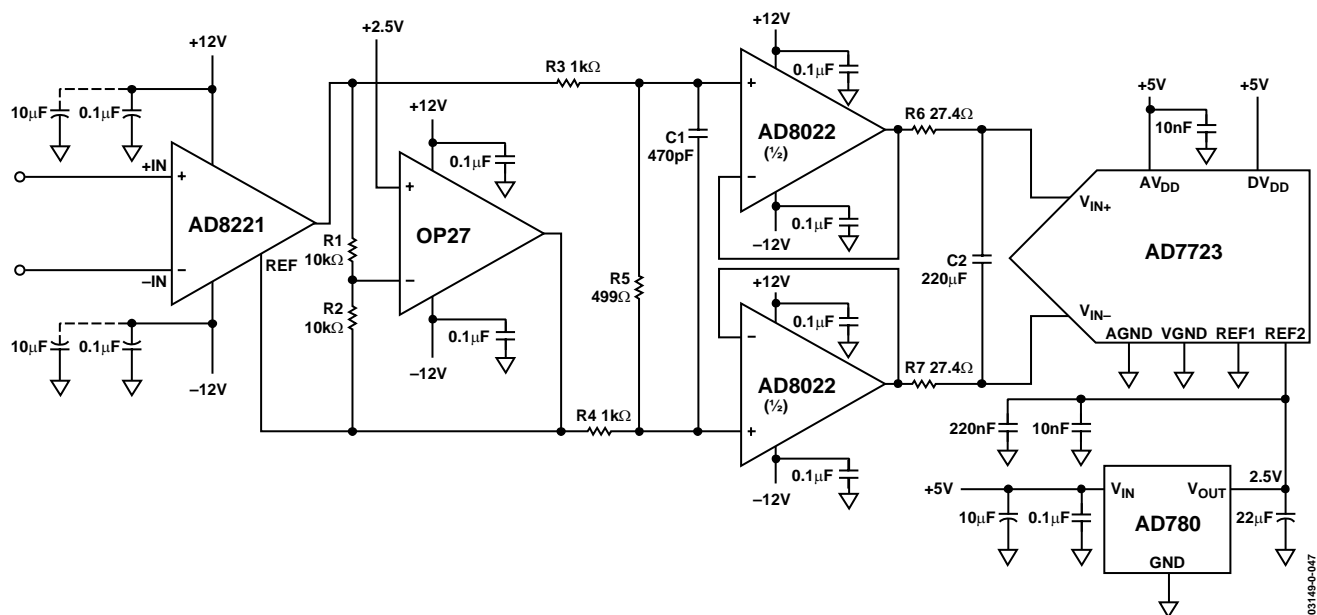

Figure 51. Interfacing to a Differential Input ADC

CONDITIONING ± 10 V SIGNALS FOR A +5 V DIFFERENTIAL INPUT ADC

There is a need in many applications to condition ± 10 V signals. However, many of today's ADCs and digital ICs operate on much lower, single-supply voltages. Furthermore, new ADCs have differential inputs because they provide better common-mode rejection, noise immunity, and performance at low supply voltages. Interfacing a ± 10 V, single-ended instrumentation amplifier to a +5 V, differential ADC may be a challenge. Interfacing the in-amp to the ADC requires attenuation and a level shift. A solution is shown in Figure 51.

In this topology, an OP27 sets the AD8221's reference voltage. The in-amp's output signal is taken across the OUT pin and the REF pin. Two 1 k Ω resistors and a 499 Ω resistor attenuate the ± 10 V signal to +4 V. An optional capacitor, C1, may serve as an antialiasing filter. An AD8022 is used to drive the ADC.

This topology has five benefits. In addition to level-shifting and attenuation, very little noise is contributed to the system. Noise from R1 and R2 is common to both of the ADC's inputs and is easily rejected. R5 adds a third of the dominant noise and therefore makes a negligible contribution to the noise of the system. The attenuator divides the noise from R3 and R4. Likewise, its noise contribution is negligible. The fourth benefit of this interface circuit is that the AD8221's acquisition time is reduced by a factor of 2. With the help of the OP27, the AD8221 only needs to deliver one-half of the full swing; therefore, signals can settle more quickly. Lastly, the AD8022 settles quickly, which is helpful because the shorter the settling time, the more bits that can be resolved when the ADC acquires data. This configuration provides attenuation, a level-shift, and a convenient interface with a differential input ADC while maintaining performance.

AC-COUPLED INSTRUMENTATION AMPLIFIER

Measuring small signals that are in the amplifier's noise or offset can be a challenge. Figure 52 shows a circuit that can improve the resolution of small ac signals. The large gain reduces the referred input noise of the amplifier to 8 nV/ $\sqrt{\text{Hz}}$. Thus, smaller signals can be measured since the noise floor is lower. DC offsets that would have been gained by 100 are eliminated from the AD8221's output by the integrator feedback network.

At low frequencies, the OP1177 forces the AD8221's output to 0 V. Once a signal exceeds $f_{\text{HIGH-PASS}}$, the AD8221 outputs the amplified input signal.

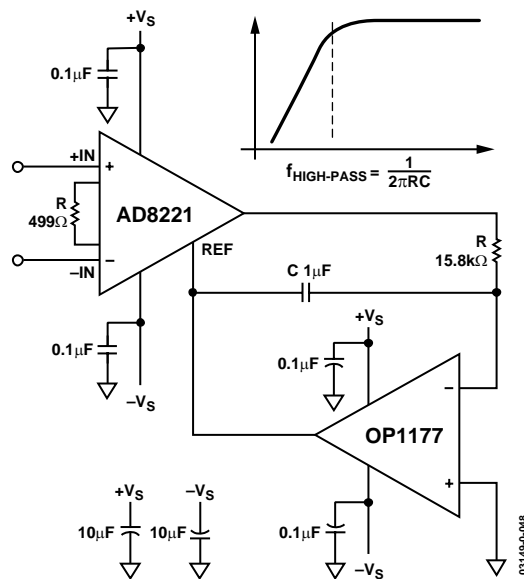

Figure 52. AC-Coupled Circuit

OUTLINE DIMENSIONS

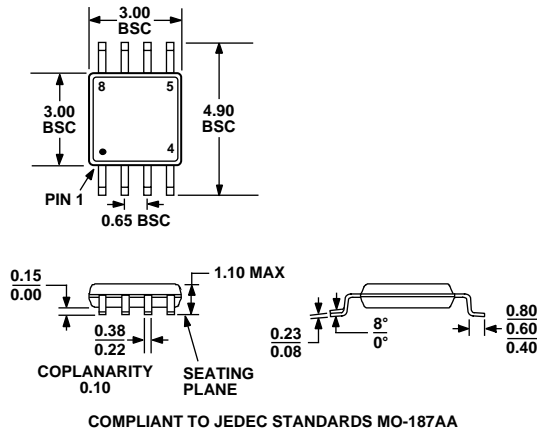

Figure 53. 8-Lead Mini Small Outline Package [MSOP] (RM-8)
Dimensions shown in millimeters

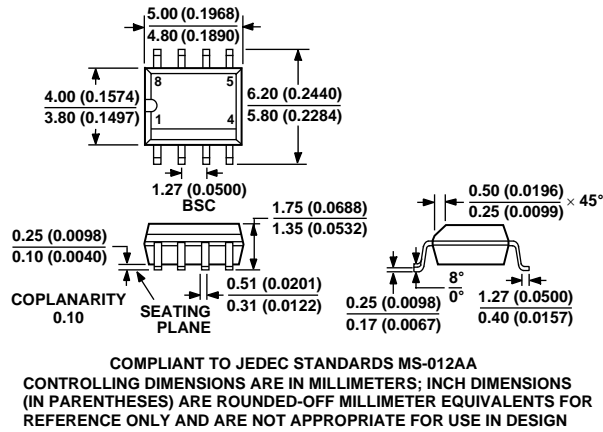

Figure 54. 8-Lead Shrink Small Outline Package [SOIC] (R-8)

ORDERING GUIDE

| Model | Temperature Range for Specified Performance | Operational ¹ Temperature Range | Package Description | Package Option | Branding |
|-----------------|---|--|---------------------|----------------|----------|
| AD8221AR | -40°C to +85°C | -40°C to 125°C | 8-Lead SOIC | R-8 | |
| AD8221AR-REEL | -40°C to +85°C | -40°C to 125°C | 13" Tape and Reel | R-8 | |
| AD8221AR-REEL7 | -40°C to +85°C | -40°C to 125°C | 7" Tape and Reel | R-8 | |
| AD8221ARM | -40°C to +85°C | -40°C to 125°C | 8-Lead MSOP | RM-8 | JLA |
| AD8221ARM-REEL | -40°C to +85°C | -40°C to 125°C | 13" Tape and Reel | RM-8 | JLA |
| AD8221ARM-REEL7 | -40°C to +85°C | -40°C to 125°C | 7" Tape and Reel | RM-8 | JLA |
| AD8221BR | -40°C to +85°C | -40°C to 125°C | 8-Lead SOIC | R-8 | |
| AD8221BR-REEL | -40°C to +85°C | -40°C to 125°C | 13" Tape and Reel | R-8 | |
| AD8221BR-REEL7 | -40°C to +85°C | -40°C to 125°C | 7" Tape and Reel | R-8 | |
| AD8221-EVAL | | | Evaluation Board | | |

¹ See Typical Performance Curves for expected operation from 85°C to 125°C.

NOTES

AD8221

NOTES