

Marketing Bulletin

DATE: July 28th, 2006
TO: All Sales Personnel
FROM: Mark Stoner
RE: Product Termination

To all concerned parties,

This bulletin is to notify all customers of the discontinuation of the following Ecliptek series effective July 28th, 2006:

Series	Description	Recommended Replacement
ECPSM29T	SMD Watch Crystal	E1WS

In compliance with our End of Life (EOL) policy, this will serve as advanced notice of product termination. New orders will not be accepted after April 30th, 2007, with delivery to conclude by July 31st 2007.

If there are any questions pertaining to this bulletin, please feel free to contact me. Thank you again for your cooperation.

Best Regards,



Mark W. Stoner
Vice President of Marketing
Ecliptek Corporation

ECPSM29T Series

- 32.768kHz watch crystal
- Miniature four pad surface mount package
- ± 20 ppm frequency tolerance
- 12.5pF load capacitance
- Tape and reel available

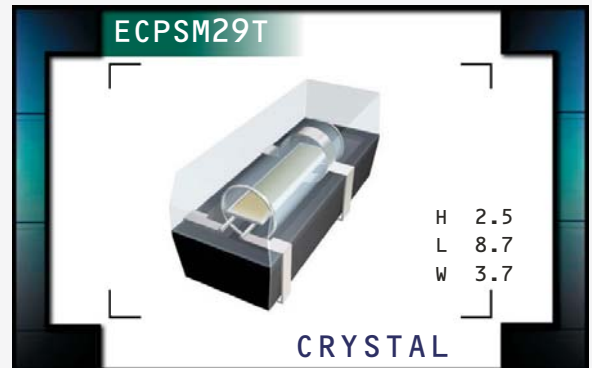

NOTES

OBSOLETE

ELECTRICAL SPECIFICATIONS

Frequency	32.768kHz
Frequency Tolerance (at 25°C)	± 20 ppm
Frequency Stability	-0.042ppm / $(\Delta^\circ\text{C})^2$ Maximum, Parabolic; Turn Over Temperature at 25°C $\pm 5^\circ\text{C}$
Operating Temperature Range	-10°C to 60°C
Aging (at 25°C)	± 3 ppm / year Maximum
Storage Temperature Range	-40°C to 85°C
Shunt Capacitance	0.85pF Typical, 2pF Maximum
Motional Capacitance	2.0fF Typical
Equivalent Series Resistance	60,000 Ohms Maximum
Insulation Resistance	500 Megaohms Minimum at 100V _{DC}
Drive Level	1 μ Watt Maximum
Load Capacitance (C _L)	12.5pF

PART NUMBERING GUIDE

ECPSM29T - 32.768K TR

PACKAGE OPTIONS

Blank=Bulk, TR=Tape and Reel

NOTES

OBSOLETE

MECHANICAL DIMENSIONS ALL DIMENSIONS IN MILLIMETERS

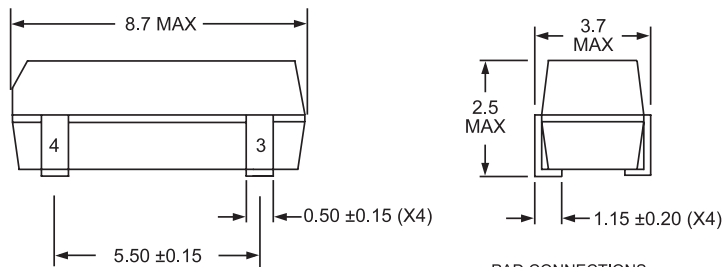

PAD CONNECTIONS

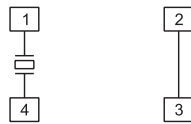

SUGGESTED SOLDER PAD LAYOUTS ALL DIMENSIONS IN MILLIMETERS

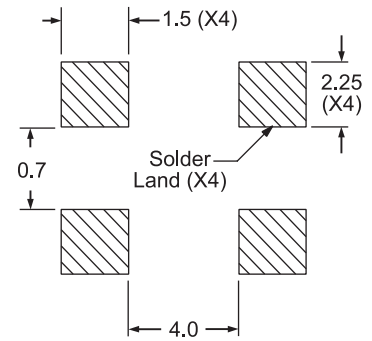

TAPE AND REEL DIMENSIONS ALL DIMENSIONS IN MILLIMETERS

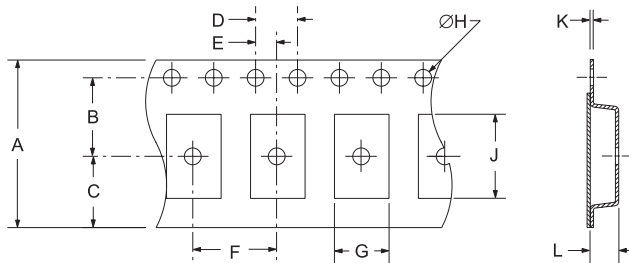

TAPE	A	B	C	D	E	
	16±.3	7.5±.1	6.75±.1	4±.2	2±.1	
	F	G	H	J	K	L
	8±.2	4.35±.1	1.5+-.2-.1	10.7±.2	.5±.05	3.7±.2

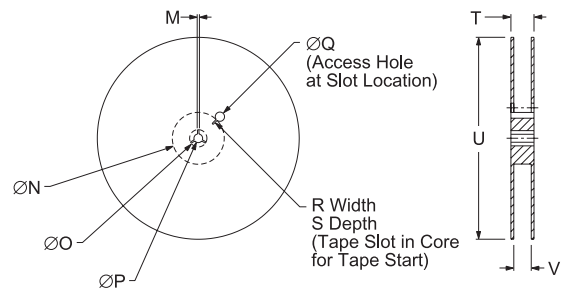

REEL	M	N	O	P	Q	
	1.5 MIN	50 MIN	20.2 MIN	13±.2	40 MIN	
	R	S	T	U	V	QTY/REEL
	2.5 MIN	10 MIN	22.4 MAX	360 MAX	16.4+2-0	3,000

PARABOLIC TEMPERATURE CURVE

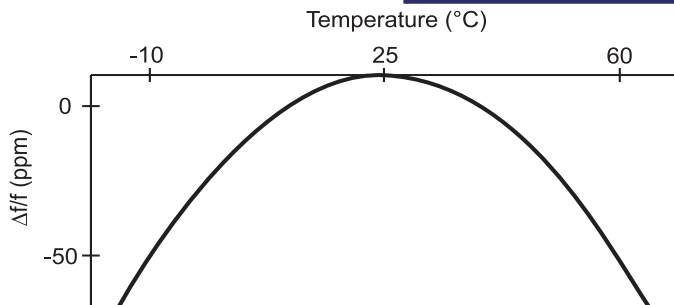

MARKING SPECIFICATIONS

Line 1: 32K XXXX
 Lot Identifier (4 or 5 Characters)
 Frequency Code
 32K or C2K

MANUFACTURER
ECLIPTEK CORP.

CATEGORY
CRYSTAL

SERIES
ECPSM29T

PACKAGE
PLASTIC

CLASS
CR14

REV. DATE
05/05