

## Marketing Bulletin

**DATE:** July 28<sup>th</sup>, 2006  
**TO:** All Sales Personnel  
**FROM:** Mark Stoner  
**RE:** Product Termination

To all concerned parties,

This bulletin is to notify all customers of the discontinuation of the following Ecliptek series effective July 28<sup>th</sup>, 2006:

<b>Series</b>	<b>Description</b>	<b>Recommended Replacement</b>
ECPSM29T	SMD Watch Crystal	E1WS

In compliance with our End of Life (EOL) policy, this will serve as advanced notice of product termination. New orders will not be accepted after April 30<sup>th</sup>, 2007, with delivery to conclude by July 31<sup>st</sup> 2007.

If there are any questions pertaining to this bulletin, please feel free to contact me. Thank you again for your cooperation.

Best Regards,

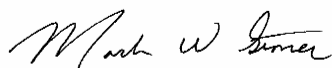

Mark W. Stoner  
Vice President of Marketing  
Ecliptek Corporation

# ECPSM29T Series

- 32.768kHz watch crystal
- Miniature four pad surface mount package
- $\pm 20$ ppm frequency tolerance
- 12.5pF load capacitance
- Tape and reel available

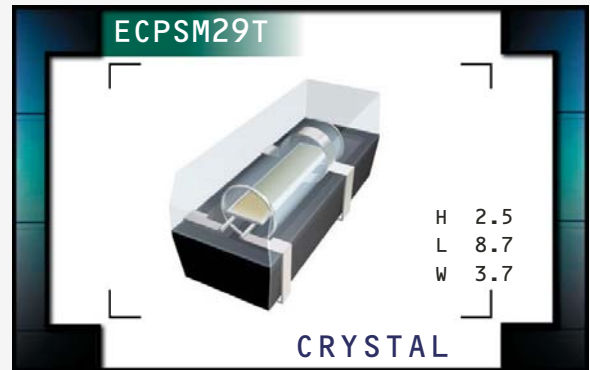

## NOTES

OBSOLETE

### ELECTRICAL SPECIFICATIONS

Frequency	32.768kHz
Frequency Tolerance (at 25°C)	$\pm 20$ ppm
Frequency Stability	-0.042ppm / $(\Delta^\circ\text{C})^2$ Maximum, Parabolic; Turn Over Temperature at 25°C $\pm 5^\circ\text{C}$
Operating Temperature Range	-10°C to 60°C
Aging (at 25°C)	$\pm 3$ ppm / year Maximum
Storage Temperature Range	-40°C to 85°C
Shunt Capacitance	0.85pF Typical, 2pF Maximum
Motional Capacitance	2.0fF Typical
Equivalent Series Resistance	60,000 Ohms Maximum
Insulation Resistance	500 Megaohms Minimum at 100V <sub>DC</sub>
Drive Level	1 $\mu$ Watt Maximum
Load Capacitance (C <sub>L</sub> )	12.5pF

# PART NUMBERING GUIDE

## ECPSM29T - 32.768K TR

### PACKAGE OPTIONS

Blank=Bulk, TR=Tape and Reel

### NOTES

OBSOLETE

#### MECHANICAL DIMENSIONS ALL DIMENSIONS IN MILLIMETERS

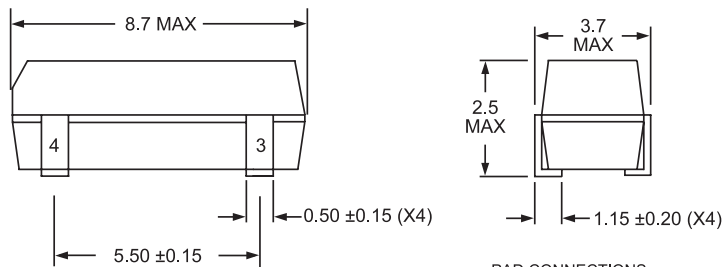

#### PAD CONNECTIONS

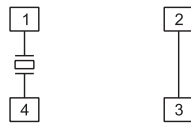

#### SUGGESTED SOLDER PAD LAYOUTS ALL DIMENSIONS IN MILLIMETERS

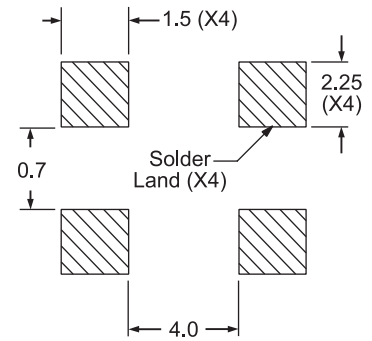

#### TAPE AND REEL DIMENSIONS ALL DIMENSIONS IN MILLIMETERS

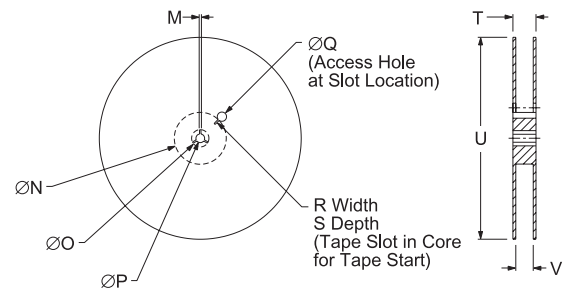
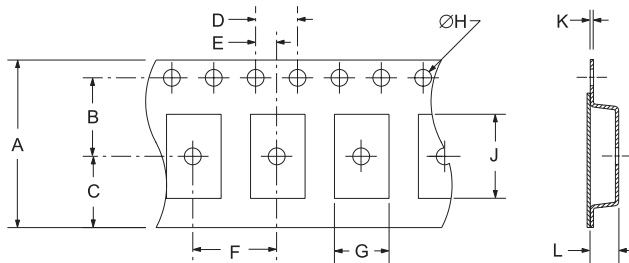

TAPE	A	B	C	D	E
	16±.3	7.5±.1	6.75±.1	4±.2	2±.1
F	G	H	J	K	L
8±.2	4.35±.1	1.5+-.2-.1	10.7±.2	.5±.05	3.7±.2

REEL	M	N	O	P	Q
	1.5 MIN	50 MIN	20.2 MIN	13±.2	40 MIN
R	S	T	U	V	QTY/REEL
2.5 MIN	10 MIN	22.4 MAX	360 MAX	16.4+2-0	3,000

#### PARABOLIC TEMPERATURE CURVE

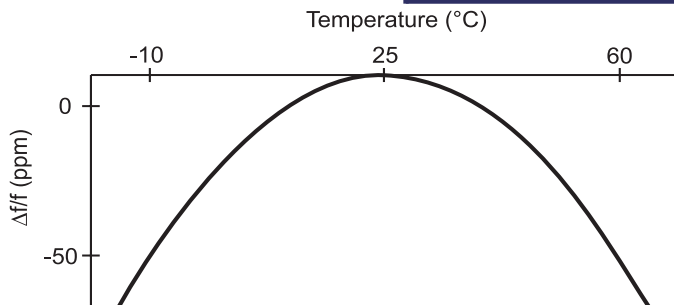

#### MARKING SPECIFICATIONS

Line 1: 32K XXXX  
 Lot Identifier (4 or 5 Characters)  
 Frequency Code  
 32K or C2K

MANUFACTURER  
ECLIPTEK CORP.

CATEGORY  
CRYSTAL

SERIES  
ECPSM29T

PACKAGE  
PLASTIC

CLASS  
CR14

REV. DATE  
05/05