

Xinger®

Ultra Low Profile 0805 Power Divider 50Ω to 50Ω

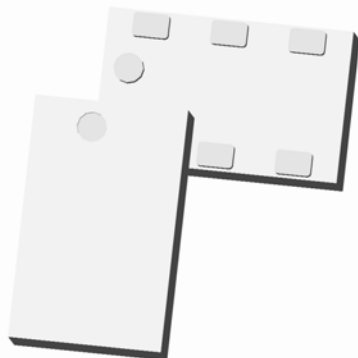

Description

The PD1722J5050D2 is a low profile, sub-miniature Wilkinson power divider in an easy to use surface mount package. The PD1722J5050D2 is ideal for high volume manufacturing and delivers higher performances than traditional printed and lumped element solutions. The PD1722J5050D2 is matched to 50 Ω and has a height profile of 0.5 mm which is ideal for high level integrations in the following markets: WCDMA, and GSM. The PD1722J5050D2 does not include the resistive element and therefore, requires an external resistor for operation. The PD1722J5050D2 is available on tape and reel for high volume manufacturing pick and place.

Detailed Electrical Specifications: Specifications subject to change without notice.

Features:	Parameter	ROOM (25°C)			Unit
		Min.	Typ.	Max	
<ul style="list-style-type: none"> • 1700-2200 MHz • 19 dB Isolation (output ports) • 0.5mm Height Profile • 50Ω Input / 50Ω Outputs • Low Insertion Loss • Surface Mountable • Tape & Reel • Non-conductive Surface • RoHS Compliant • External resistors required 	Frequency	1700		2200	MHz
	Input Port Impedance		50		Ω
	Output Port Impedance		50		Ω
	Return Loss	11	14		dB
	Insertion Loss*		0.5	0.7	dB
	Amplitude Balance		0.1	0.3	dB
	Phase Balance		1	3	Degrees
	Isolation (Output Ports)	17	19		dB
	Power Handling			2	Watts
	Operating Temperature	-55		+85	°C

* Insertion Loss stated at room temperature (Insertion Loss is approximately 0.1 dB higher at +85 °C)

Outline Drawing

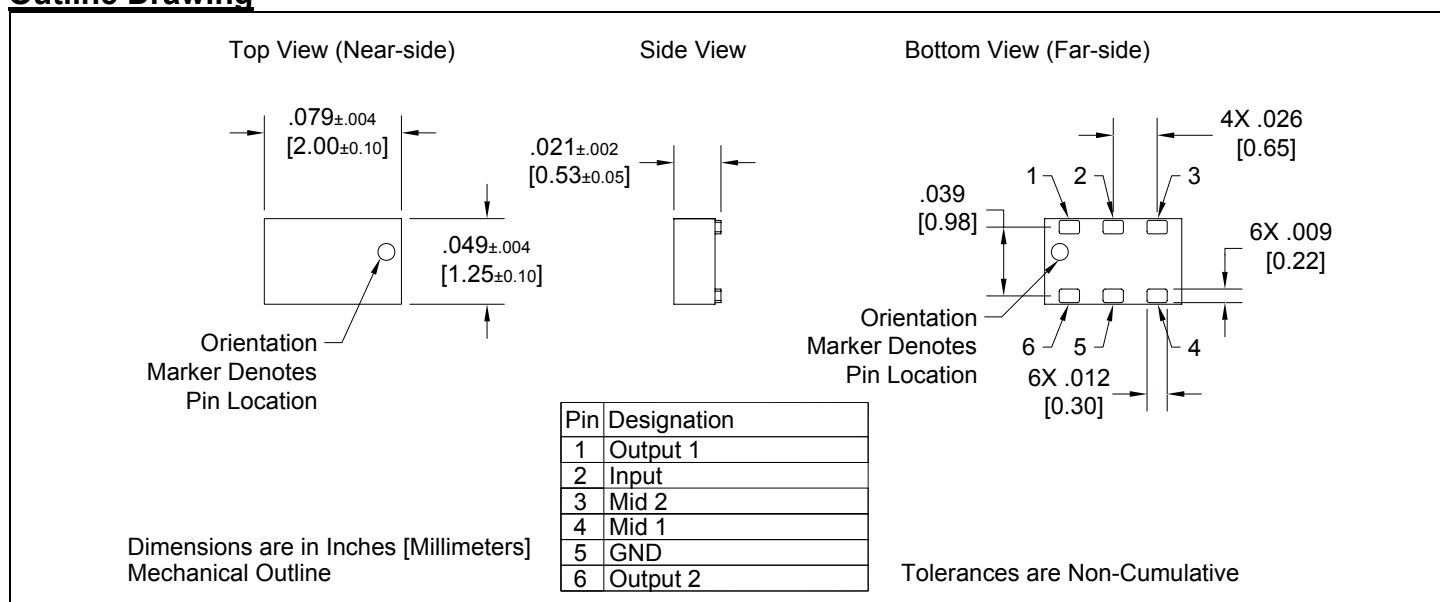

Typical Broadband Performance: 500 MHz. to 6.0 GHz.

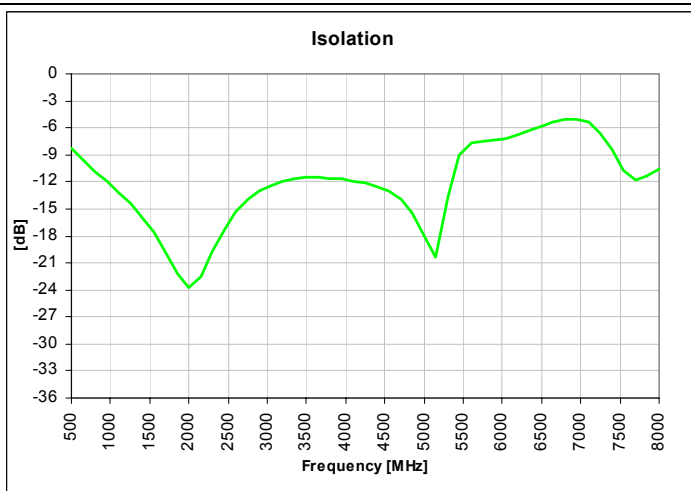
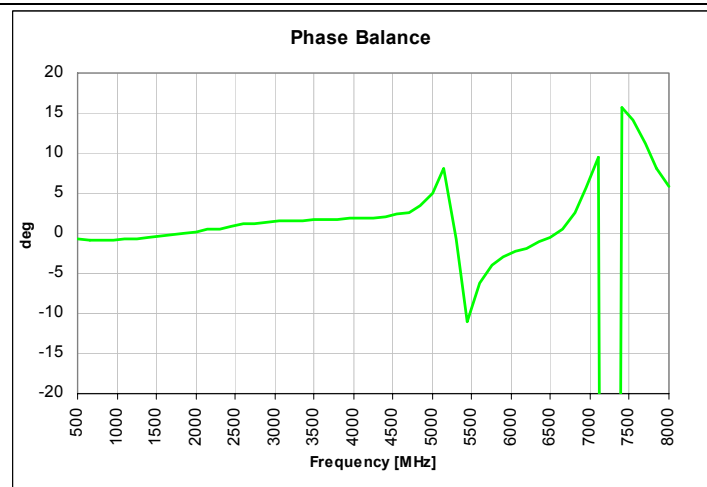
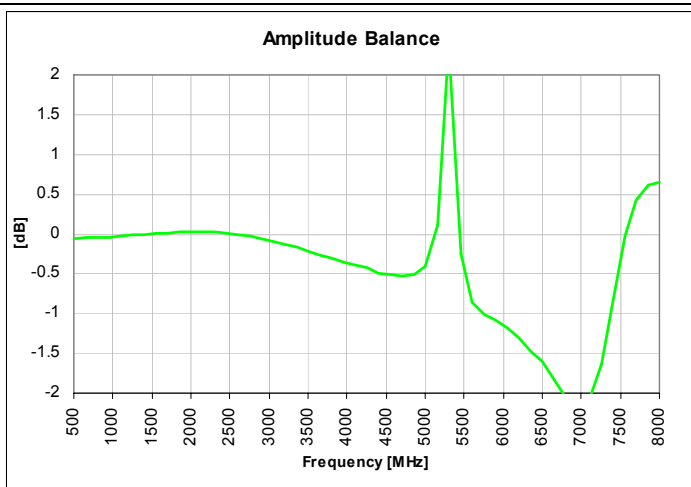
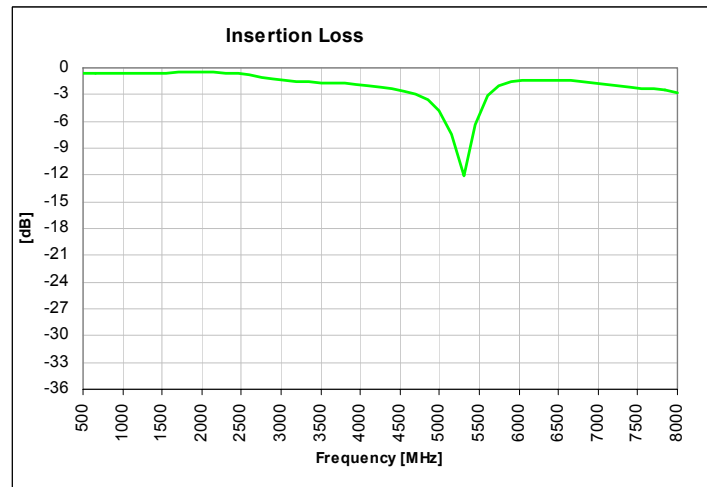
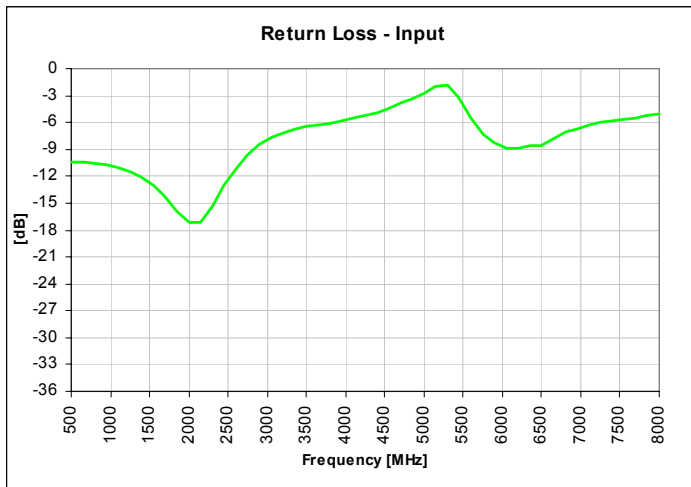

Typical Performance: 1600 MHz. to 2300 MHz.

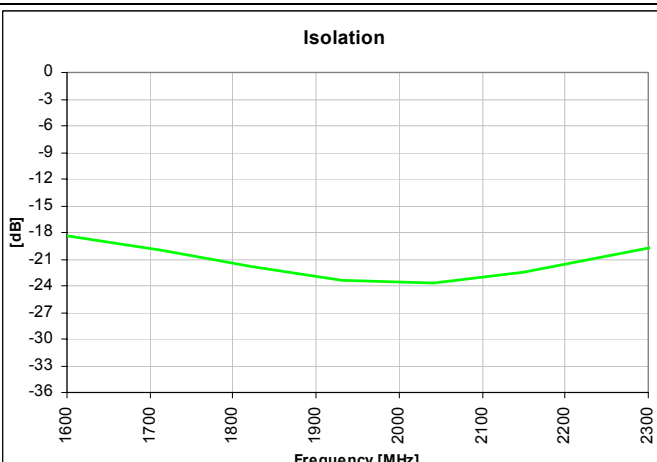
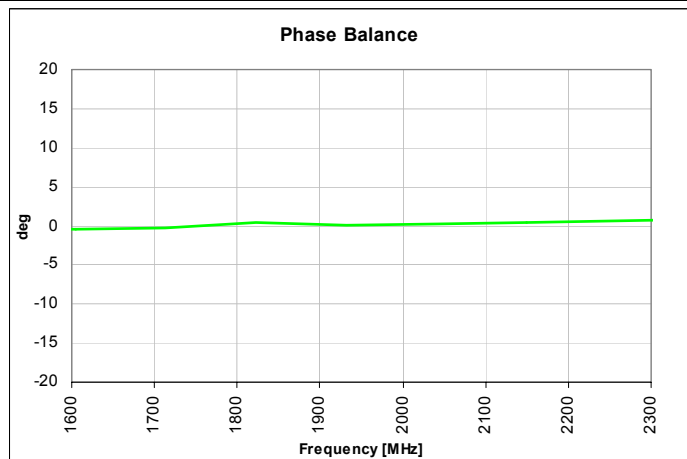
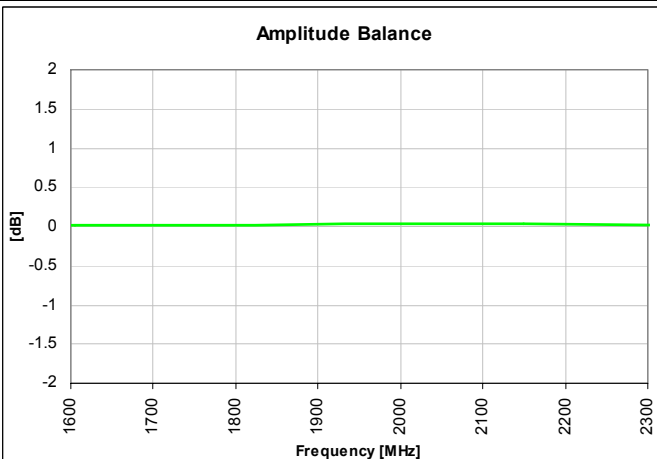
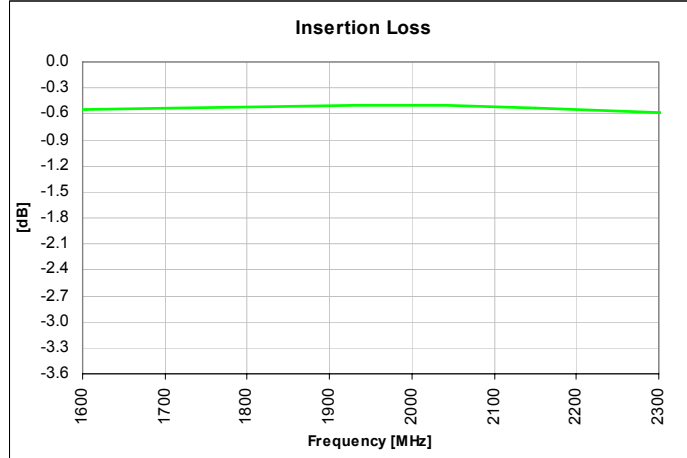

Mounting Configuration:

In order for Xinger surface mount components to work optimally, the proper impedance transmission lines must be used to connect to the RF ports. If this condition is not satisfied, insertion loss, Isolation and VSWR may not meet published specifications.

An example of the PCB footprint used in the testing of these parts is shown below. In specific designs, the transmission line widths need to be adjusted to the unique dielectric coefficients and thicknesses as well as varying pick and place equipment tolerances. In addition, since the PD1722J5050D2 is a Wilkinson power divider, external 0402 100Ω and 200Ω resistors must be mounted in locations R1 and R2 respectively, as shown in the Figure below.

All of the Xinger components are constructed from ceramic filled PTFE composites which possess excellent electrical and mechanical stability having X and Y thermal coefficient of expansion (CTE) of 17 ppm/°C.

Pad Footprint w/ 0402 Resistor Locations

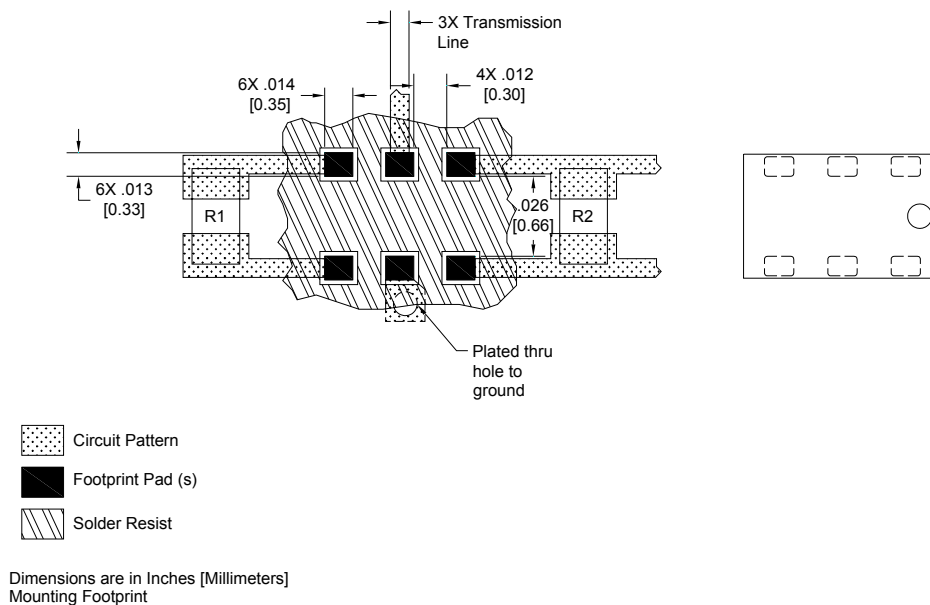

Packaging and Ordering Information

Parts are available in reels and are packaged per EIA 481-2. Parts are oriented in tape and reel as shown below. Minimum order quantities are 4000 per reel. See Model Numbers below for further ordering information.

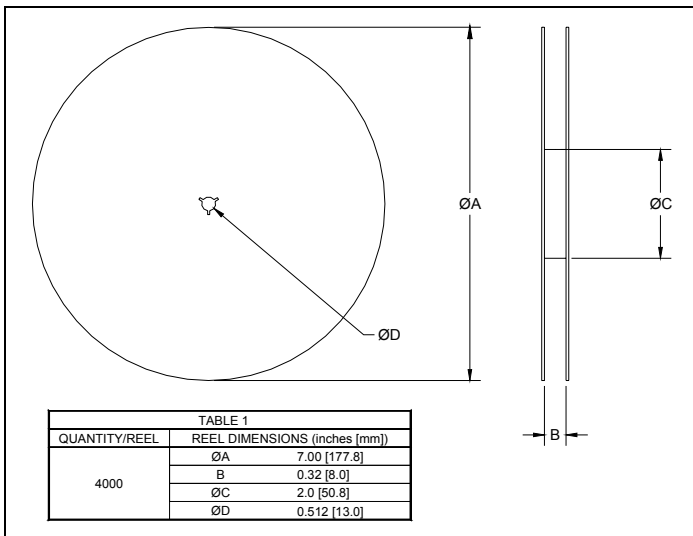
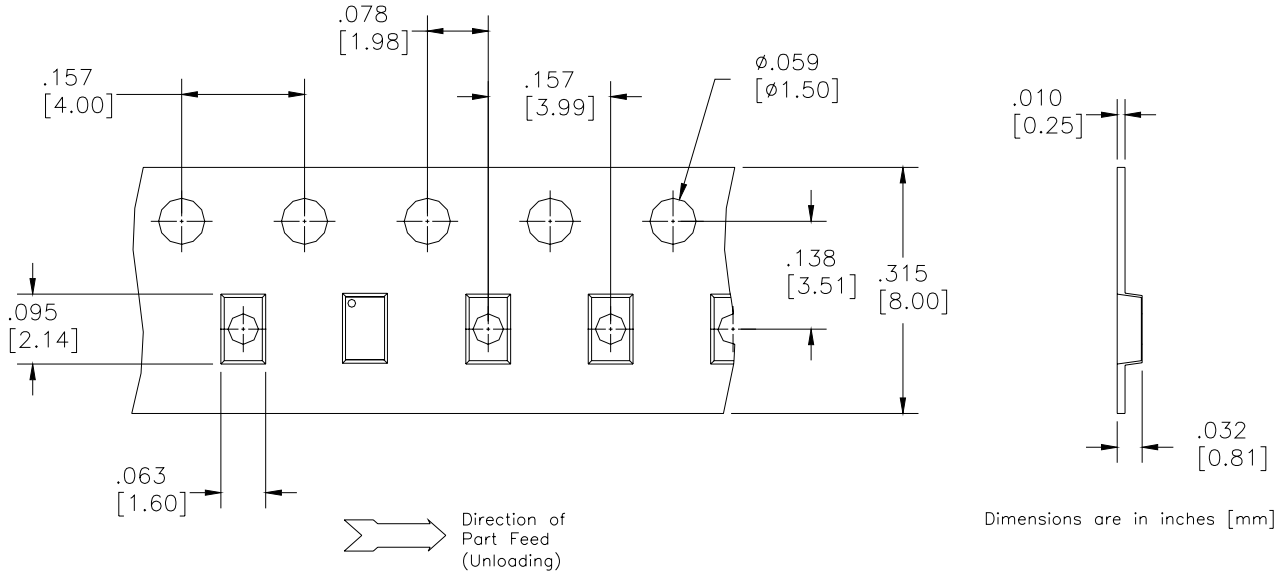

BD 2425 J 50 100 A 00

Function	Frequency	Package Dimensions	Unbalanced Impedance	Balanced Impedance + Coupling	Plating Finish	Codes
B = Balun	0110 = 100 – 1000 MHz	A = 150 x 150 mils	50 = 50 Ohm	25 = 25 Ω Balanced	A = Gold	
BD = Balun + DC	0810 = 800 – 1000 MHz	(4mm x 4mm)	75 = 75 Ohm	30 = 30 Ω Balanced	P = Tin-Lead	
F = Filter	0922 = 950 – 2150 MHz	C = 120 x 120 mils		50 = 50 Ω Balanced		
FB = Filter / Balun	0826 = 800 – 6200 MHz	(3mm x 3mm)		75 = 75 Ω Balanced		
C = 3dB Coupler	1222 = 1200 – 2200 MHz	E = 100 x 80 mils		100 = 100 Ω Balanced		
DC = Directional	1416 = 1400 – 1600 MHz	(2.5mm x 2mm)		150 = 150 Ω Balanced		
J = RF Jumper	1722 = 1700 – 2200 MHz	J = 80 x 50 mils		200 = 200 Ω Balanced		
X = RF cross over	2326 = 2300 – 2600 MHz	(2mm x 1.25mm)		300 = 300 Ω Balanced		
	2425 = 2400 – 2500 MHz	L = 60 x 30 mils		400 = 400 Ω Balanced		
	3150 = 3100 – 5000 MHz	(1.5mm x 0.75mm)		03 = 3dB Hybrid		
	3436 = 3400 – 3600 MHz	N = 40 x 40 mils		10 = 10dB Directional		
	4859 = 4800 – 5900MHz	(1mm x 1mm)		20 = 20dB Directional		
	5153 = 5100 – 5300 MHz					
	5159 = 5100 – 5900 MHz					
	5759 = 5700 – 5900 MHz					

USA/Canada: (315) 432-8909
 Toll Free: (800) 411-6596
 Europe: +44 2392-232392

Available on Tape and Reel for Pick and Place Manufacturing.



Anaren

What'll we think of next?™