

RF Power Field Effect Transistors

N-Channel Enhancement-Mode Lateral MOSFETs

Designed for PCN and PCS base station applications with frequencies from 1900 to 2000 MHz. Suitable for TDMA, CDMA and multicarrier amplifier applications.

- Typical 2-Carrier N-CDMA Performance for $V_{DD} = 26$ Volts, $I_{DQ} = 1300$ mA, $f_1 = 1958.75$ MHz, $f_2 = 1961.25$ MHz
 IS-95 CDMA (Pilot, Sync, Paging, Traffic Codes 8 Through 13)
 1.2288 MHz Channel Bandwidth Carrier. Adjacent Channels Measured over a 30 kHz Bandwidth at $f_1 - 885$ kHz and $f_2 + 885$ kHz. Distortion Products Measured over 1.2288 MHz Bandwidth at $f_1 - 2.5$ MHz and $f_2 + 2.5$ MHz. Peak/Avg. = 9.8 dB @ 0.01% Probability on CCDF.
 Output Power — 24 Watts Avg.
 Power Gain — 13.6 dB
 Efficiency — 22%
 ACPR — -51 dB
 IM3 — -37.0 dBc
- Capable of Handling 5:1 VSWR, @ 26 Vdc, 1960 MHz, 125 Watts CW Output Power

Features

- Internally Matched for Ease of Use
- High Gain, High Efficiency and High Linearity
- Integrated ESD Protection
- Designed for Maximum Gain and Insertion Phase Flatness
- Excellent Thermal Stability
- Characterized with Series Equivalent Large-Signal Impedance Parameters
- RoHS Compliant
- In Tape and Reel. R3 Suffix = 250 Units per 56 mm, 13 inch Reel.

MRF19125R3
MRF19125SR3

1930 - 1990 MHz, 125 W, 26 V
LATERAL N-CHANNEL
RF POWER MOSFETs

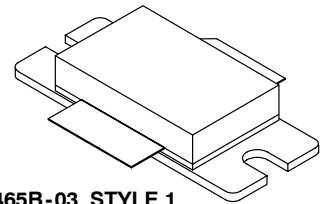

CASE 465B-03, STYLE 1
NI-880
MRF191225R3

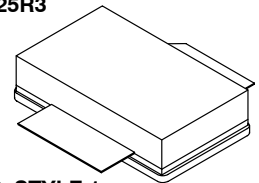

CASE 465C-02, STYLE 1
NI-880S
MRF19125SR3

Table 1. Maximum Ratings

Rating	Symbol	Value	Unit
Drain-Source Voltage	V_{DSS}	-0.5, +65	Vdc
Gate-Source Voltage	V_{GS}	-0.5, +15	Vdc
Total Device Dissipation @ $T_C = 25^\circ\text{C}$ Derate above 25°C	P_D	330 1.89	W W/ $^\circ\text{C}$
Storage Temperature Range	T_{stg}	- 65 to +150	$^\circ\text{C}$
Case Operating Temperature	T_C	150	$^\circ\text{C}$
Operating Junction Temperature	T_J	200	$^\circ\text{C}$

Table 2. Thermal Characteristics

Characteristic	Symbol	Value	Unit
Thermal Resistance, Junction to Case	$R_{\theta JC}$	0.53	$^\circ\text{C}/\text{W}$

Table 3. ESD Protection Characteristics

Test Conditions	Class
Human Body Model	2 (Minimum)
Machine Model	M3 (Minimum)

Table 4. Electrical Characteristics ($T_C = 25^\circ\text{C}$ unless otherwise noted)

Characteristic	Symbol	Min	Typ	Max	Unit
Off Characteristics					
Drain-Source Breakdown Voltage ($V_{GS} = 0 \text{ Vdc}$, $I_D = 100 \mu\text{Adc}$)	$V_{(BR)DSS}$	65	—	—	Vdc
Gate-Source Leakage Current ($V_{GS} = 5 \text{ Vdc}$, $V_{DS} = 0 \text{ Vdc}$)	I_{GSS}	—	—	1	μAdc
Zero Gate Voltage Drain Leakage Current ($V_{DS} = 26 \text{ Vdc}$, $V_{GS} = 0 \text{ Vdc}$)	I_{DSS}	—	—	10	μAdc
On Characteristics					
Forward Transconductance ($V_{DS} = 10 \text{ Vdc}$, $I_D = 3 \text{ Adc}$)	g_{fs}	—	9	—	S
Gate Threshold Voltage ($V_{DS} = 10 \text{ Vdc}$, $I_D = 300 \mu\text{Adc}$)	$V_{GS(th)}$	2	—	4	Vdc
Gate Quiescent Voltage ($V_{DS} = 26 \text{ Vdc}$, $I_D = 1300 \text{ mAdc}$)	$V_{GS(Q)}$	2.5	3.9	4.5	Vdc
Drain-Source On-Voltage ($V_{GS} = 10 \text{ Vdc}$, $I_D = 3 \text{ Adc}$)	$V_{DS(on)}$	—	0.185	0.21	Vdc
Dynamic Characteristics					
Reverse Transfer Capacitance (1) ($V_{DS} = 26 \text{ Vdc}$, $V_{GS} = 0$, $f = 1 \text{ MHz}$)	C_{rss}	—	5.4	—	pF
Functional Tests (In Freescale Test Fixture) 2-Carrier N-CDMA, 1.2288 MHz Channel Bandwidth Carriers. Peak/Avg = 9.8 dB @ 0.01% Probability on CCDF.					
Common-Source Amplifier Power Gain ($V_{DD} = 26 \text{ Vdc}$, $P_{out} = 24 \text{ W Avg}$, $I_{DQ} = 1300 \text{ mA}$, $f_1 = 1930 \text{ MHz}$, $f_2 = 1932.5 \text{ MHz}$ and $f_1 = 1987.5 \text{ MHz}$, $f_2 = 1990 \text{ MHz}$)	G_{ps}	12	13.5	—	dB
Drain Efficiency ($V_{DD} = 26 \text{ Vdc}$, $P_{out} = 24 \text{ W Avg}$, $I_{DQ} = 1300 \text{ mA}$, $f_1 = 1930 \text{ MHz}$, $f_2 = 1932.5 \text{ MHz}$ and $f_1 = 1987.5 \text{ MHz}$, $f_2 = 1990 \text{ MHz}$)	η	19	22	—	%
Intermodulation Distortion ($V_{DD} = 26 \text{ Vdc}$, $P_{out} = 24 \text{ W Avg}$, $I_{DQ} = 1300 \text{ mA}$, $f_1 = 1930 \text{ MHz}$, $f_2 = 1932.5 \text{ MHz}$ and $f_1 = 1987.5 \text{ MHz}$, $f_2 = 1990 \text{ MHz}$; IM3 measured over 1.2288 MHz Bandwidth at $f_1 - 2.5 \text{ MHz}$ and $f_2 + 2.5 \text{ MHz}$)	IM3	—	-37	-35	dBc
Adjacent Channel Power Ratio ($V_{DD} = 26 \text{ Vdc}$, $P_{out} = 24 \text{ W Avg}$, $I_{DQ} = 1300 \text{ mA}$, $f_1 = 1930 \text{ MHz}$, $f_2 = 1932.5 \text{ MHz}$ and $f_1 = 1987.5 \text{ MHz}$, $f_2 = 1990 \text{ MHz}$; ACPR measured over 30 kHz Bandwidth at $f_1 - 885 \text{ MHz}$ and $f_2 + 885 \text{ MHz}$)	ACPR	—	-51	-47	dBc
Input Return Loss ($V_{DD} = 26 \text{ Vdc}$, $P_{out} = 24 \text{ W Avg}$, $I_{DQ} = 1300 \text{ mA}$, $f_1 = 1930 \text{ MHz}$, $f_2 = 1932.5 \text{ MHz}$ and $f_1 = 1987.5 \text{ MHz}$, $f_2 = 1990 \text{ MHz}$)	IRL	—	-13	-9	dB

1. Part is internally matched both on input and output.

(continued)

Table 4. Electrical Characteristics ($T_C = 25^\circ\text{C}$ unless otherwise noted) (continued)

Characteristic	Symbol	Min	Typ	Max	Unit
Functional Tests (In Freescale Test Fixture)					
Two-Tone Common-Source Amplifier Power Gain ($V_{DD} = 26\text{ Vdc}$, $P_{out} = 125\text{ W PEP}$, $I_{DQ} = 1300\text{ mA}$, $f_1 = 1930\text{ MHz}$, $f_2 = 1990\text{ MHz}$, Tone Spacing = 100 kHz)	G_{ps}	—	13.5	—	dB
Two-Tone Drain Efficiency ($V_{DD} = 26\text{ Vdc}$, $P_{out} = 125\text{ W PEP}$, $I_{DQ} = 1300\text{ mA}$, $f_1 = 1930\text{ MHz}$, $f_2 = 1990\text{ MHz}$, Tone Spacing = 100 kHz)	η	—	35	—	%
Third Order Intermodulation Distortion ($V_{DD} = 26\text{ Vdc}$, $P_{out} = 125\text{ W PEP}$, $I_{DQ} = 1300\text{ mA}$, $f_1 = 1930\text{ MHz}$, $f_2 = 1990\text{ MHz}$, Tone Spacing = 100 kHz)	IMD	—	-30	—	dBc
Input Return Loss ($V_{DD} = 26\text{ Vdc}$, $P_{out} = 125\text{ W PEP}$, $I_{DQ} = 1300\text{ mA}$, $f_1 = 1930\text{ MHz}$, $f_2 = 1990\text{ MHz}$, Tone Spacing = 100 kHz)	IRL	—	-13	—	dB
P_{out} : 1 dB Compression Point ($V_{DD} = 26\text{ Vdc}$, $I_{DQ} = 1300\text{ mA}$, $f = 1990\text{ MHz}$)	P1dB	—	130	—	W

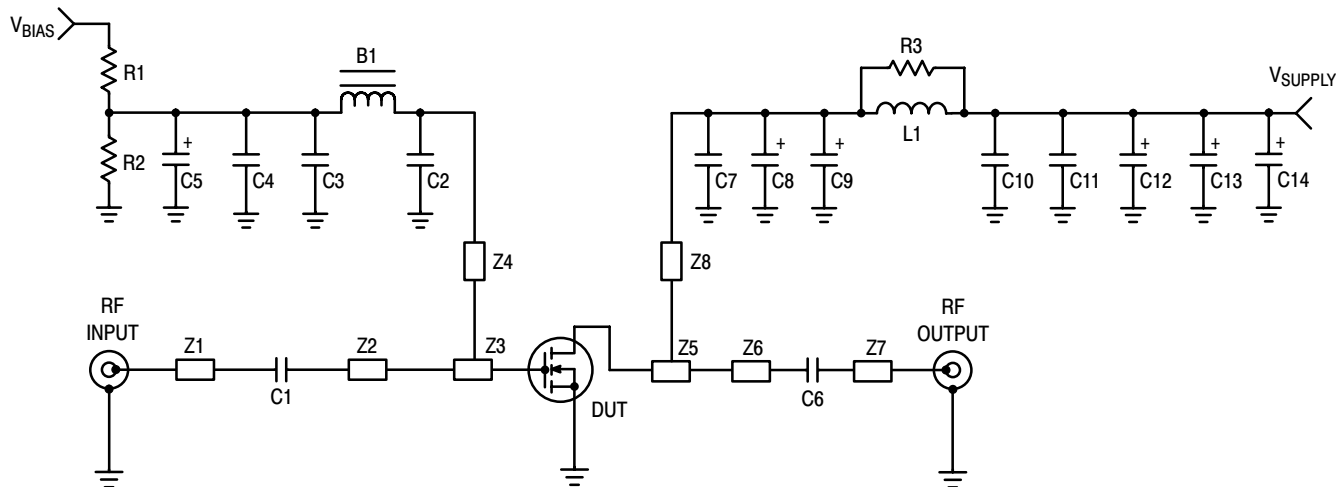

Z1, Z7 0.500" x 0.084" Microstrip
 Z2 1.105" x 0.084" Microstrip
 Z3 0.360" x 0.895" Microstrip
 Z4 0.920" x 0.048" Microstrip
 Z5 0.605" x 1.195" Microstrip
 Z6 0.800" x 0.084" Microstrip
 Z8 0.660" x 0.095" Microstrip

Board 0.030" Glass Teflon[®],
 Keene GX-0300-55-22, $\epsilon_r = 2.55$
 PCB Etched Circuit Boards
 MRF19125 Rev. 5, CMR

Figure 1. MRF19125R3(SR3) Test Circuit Schematic

Table 5. MRF19125R3(SR3) Test Circuit Component Designations and Values

Designators	Description
B1	Short Ferrite Bead, Fair Rite #2743019447
C1	51 pF Chip Capacitor, ATC #100B510JCA500X
C2, C7	5.1 pF Chip Capacitors, ATC #100B5R1JCA500X
C3, C10	1000 pF Chip Capacitors, ATC #100B102JCA500X
C4, C11	0.1 μ F Chip Capacitors, Kemet #CDR33BX104AKWS
C5	0.1 μ F Tantalum Chip Capacitor, Kemet #T491C105M050
C6	10 pF Chip Capacitor, ATC #100B100JCA500X
C8	10 μ F Tantalum Chip Capacitor, Kemet #T491X106K035AS4394
C9, C12, C13, C14	22 μ F Tantalum Chip Capacitors, Kemet #T491X226K035AS4394
L1	1 Turn, #20 AWG, 0.100" ID
N1, N2	Type N Flange Mounts, Omni Spectra #3052-1648-10
R1	1.0 k Ω , 1/8 W Chip Resistor
R2	220 k Ω , 1/8 W Chip Resistor
R3	10 Ω , 1/8 W Chip Resistor

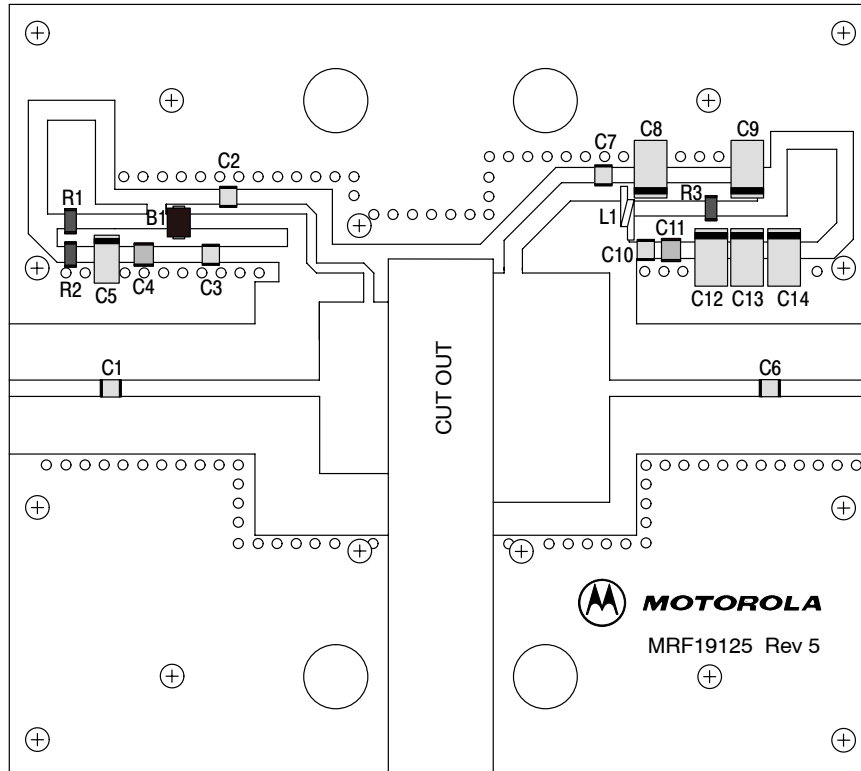

Freescale has begun the transition of marking Printed Circuit Boards (PCBs) with the Freescale Semiconductor signature/logo. PCBs may have either Motorola or Freescale markings during the transition period. These changes will have no impact on form, fit or function of the current product.

Figure 2. MRF19125R3(SR3) Test Circuit Component Layout

TYPICAL CHARACTERISTICS

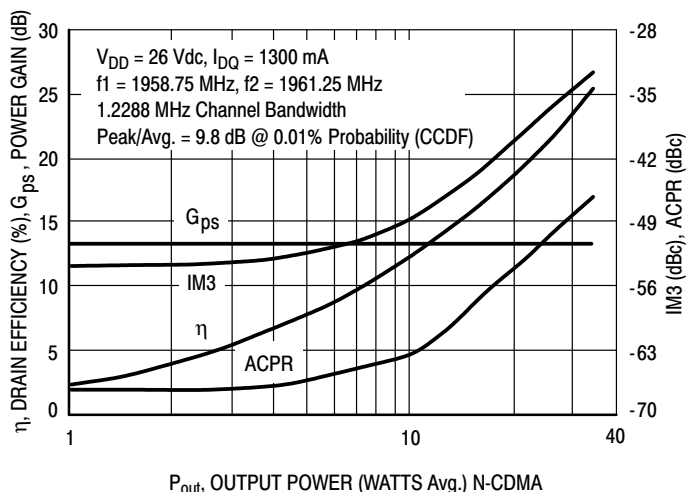

Figure 3. 2-Carrier CDMA ACPR, IM3, Power Gain and Drain Efficiency versus Output Power

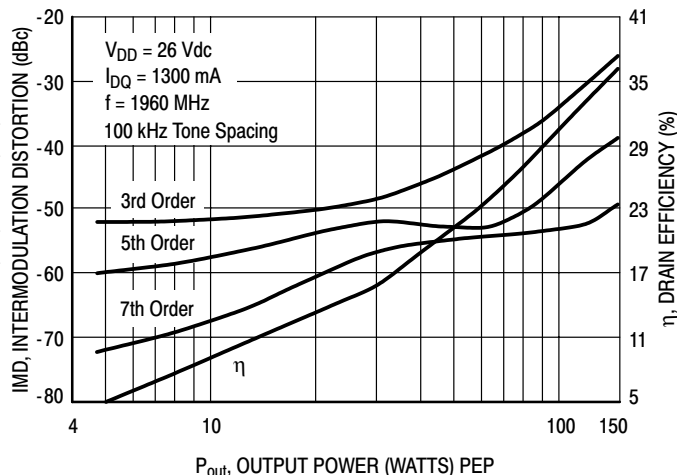

Figure 4. Intermodulation Distortion Products versus Output Power

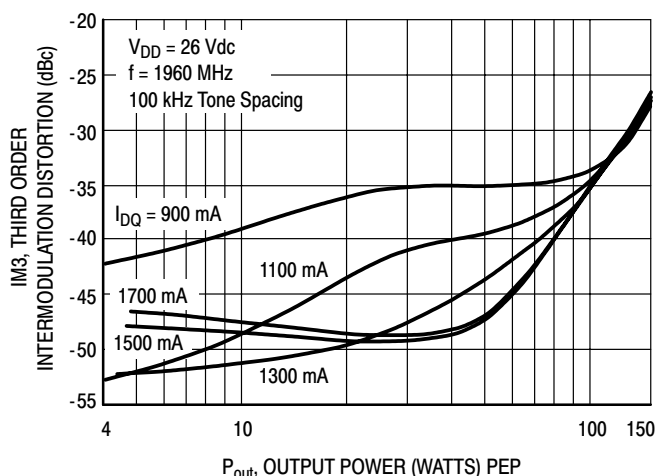

Figure 5. Third Order Intermodulation Distortion versus Output Power

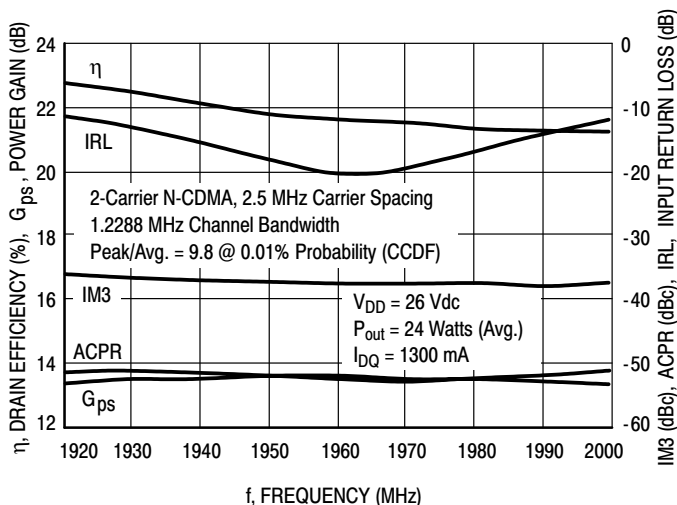

Figure 6. 2-Carrier N-CDMA Broadband Performance

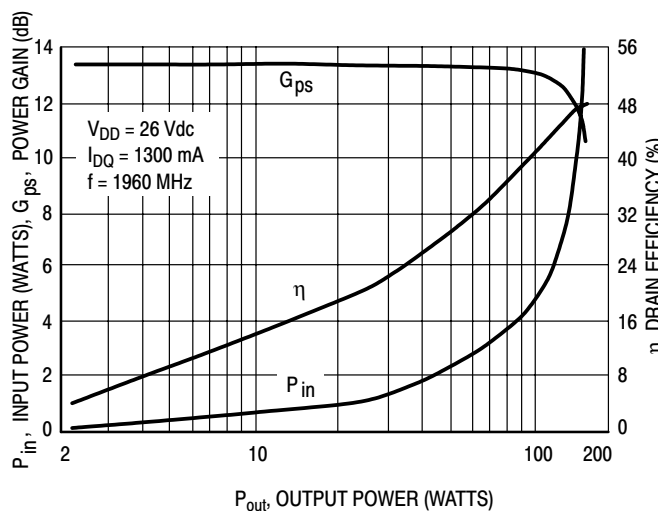

Figure 7. CW Performance

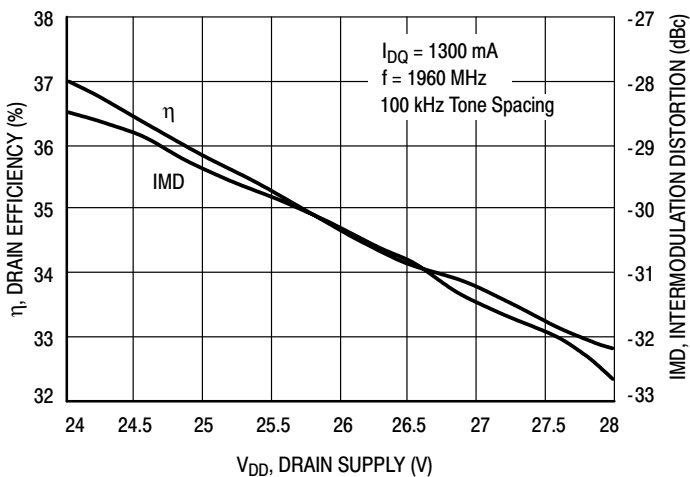

Figure 8. Two-Tone Intermodulation Distortion and Drain Efficiency versus Drain Supply

TYPICAL CHARACTERISTICS

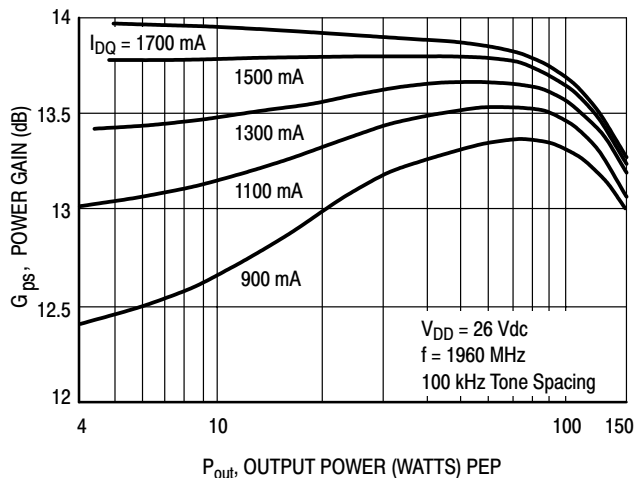

Figure 9. Two-Tone Power Gain versus Output Power

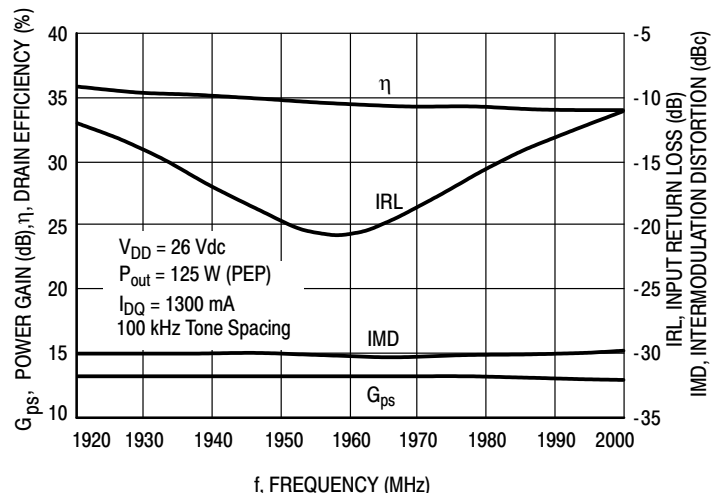

Figure 10. Two-Tone Broadband Performance

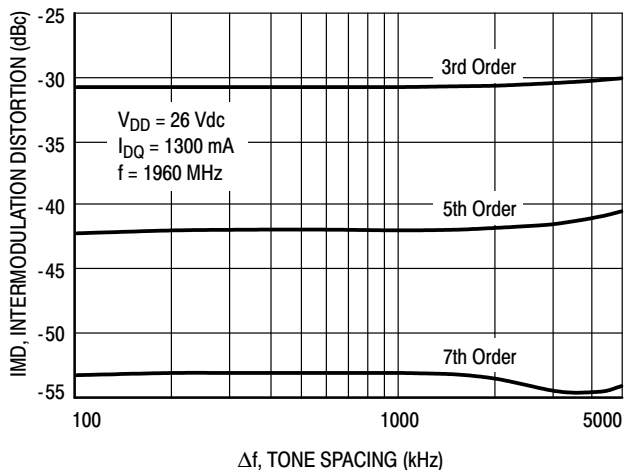
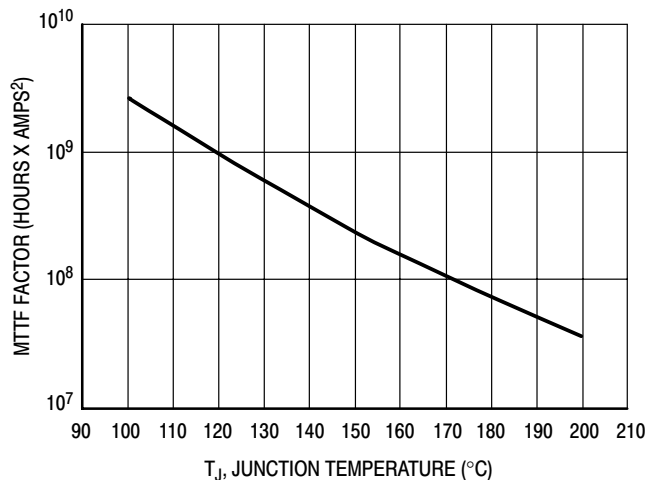

Figure 11. Intermodulation Distortion Products versus Two-Tone Tone Spacing



This above graph displays calculated MTTF in hours x ampere² drain current. Life tests at elevated temperatures have correlated to better than $\pm 10\%$ of the theoretical prediction for metal failure. Divide MTTF factor by I_D^2 for MTTF in a particular application.

Figure 12. MTTF Factor versus Junction Temperature

N-CDMA TEST SIGNAL

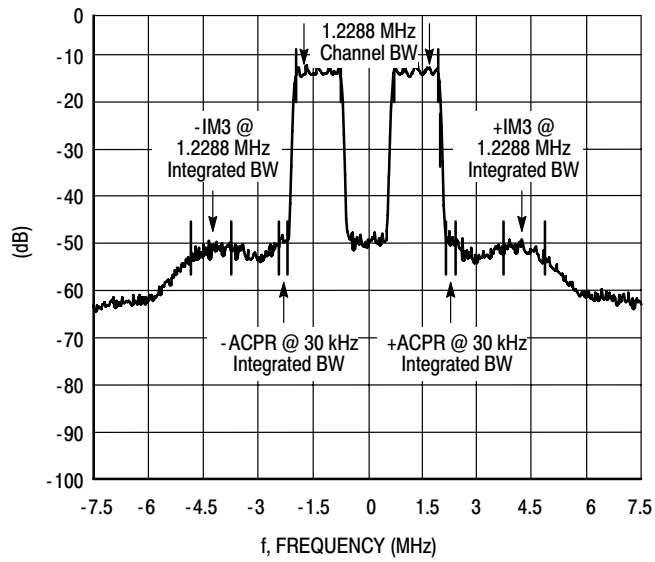
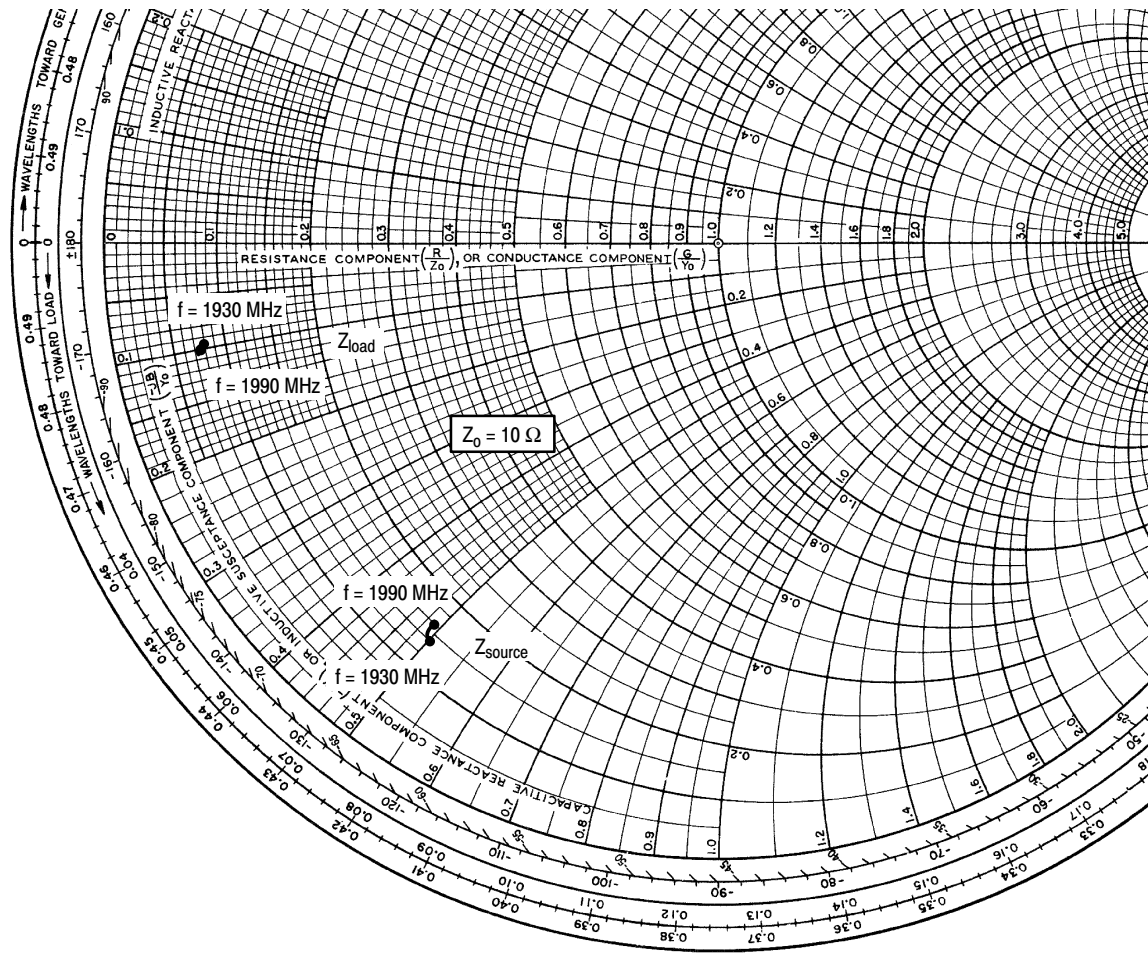

Figure 14. 2-Carrier N-CDMA Spectrum



$V_{DD} = 26\text{ V}$, $I_{DQ} = 1300\text{ mA}$, $P_{out} = 24\text{ W (Avg.)}$

f MHz	Z_{source} Ω	Z_{load} Ω
1930	$1.43 - j5.01$	$0.75 - j0.93$
1960	$1.51 - j4.88$	$0.71 - j0.89$
1990	$1.56 - j4.93$	$0.68 - j1.02$

Z_{source} = Test circuit impedance as measured from gate to ground.

Z_{load} = Test circuit impedance as measured from drain to ground.

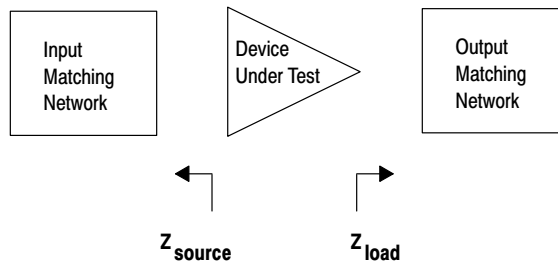
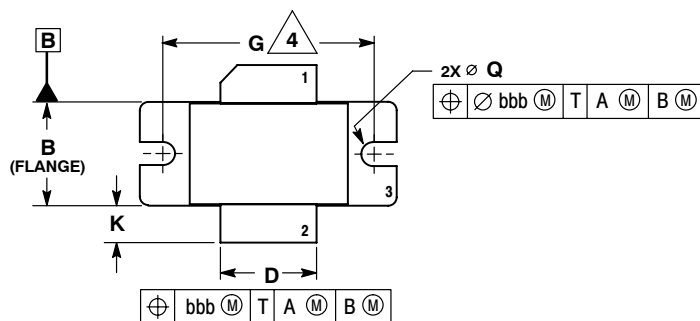

Figure 13. Series Equivalent Source and Load Impedance

NOTES

PACKAGE DIMENSIONS



- NOTES:
1. DIMENSIONING AND TOLERANCING PER ANSI Y14.5M-1994.
 2. CONTROLLING DIMENSION: INCH.
 3. DIMENSION H IS MEASURED 0.030 (0.762) AWAY FROM PACKAGE BODY.
 4. RECOMMENDED BOLT CENTER DIMENSION OF 1.16 (29.57) BASED ON M3 SCREW.

DIM	INCHES		MILLIMETERS	
	MIN	MAX	MIN	MAX
A	1.335	1.345	33.91	34.16
B	0.535	0.545	13.6	13.8
C	0.147	0.200	3.73	5.08
D	0.495	0.505	12.57	12.83
E	0.035	0.045	0.89	1.14
F	0.003	0.006	0.08	0.15
G	1.100	BSC	27.94	BSC
H	0.057	0.067	1.45	1.70
K	0.175	0.205	4.44	5.21
M	0.872	0.888	22.15	22.55
N	0.871	0.889	19.30	22.60
Q	Ø.118	Ø.138	Ø3.00	Ø3.51
R	0.515	0.525	13.10	13.30
S	0.515	0.525	13.10	13.30
aaa	0.007 REF		0.178 REF	
bbb	0.010 REF		0.254 REF	
ccc	0.015 REF		0.381 REF	

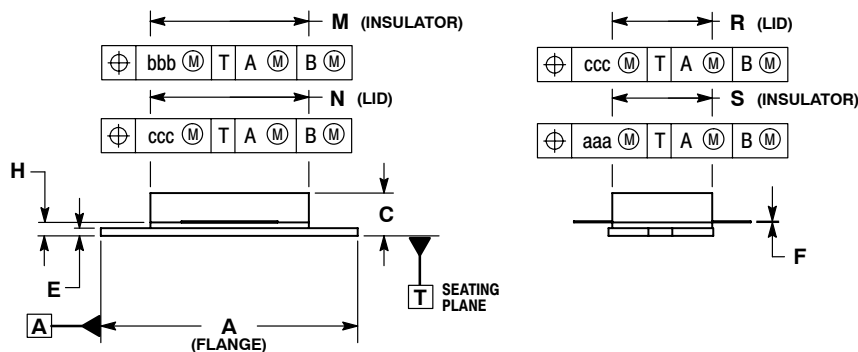

- STYLE 1:
 PIN 1. DRAIN
 2. GATE
 3. SOURCE

**CASE 465B-03
 ISSUE D
 NI-880
 MRF19125R3**

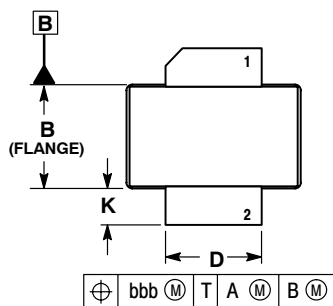

- NOTES:
1. DIMENSIONING AND TOLERANCING PER ANSI Y14.5M-1994.
 2. CONTROLLING DIMENSION: INCH.
 3. DIMENSION H IS MEASURED 0.030 (0.762) AWAY FROM PACKAGE BODY.

DIM	INCHES		MILLIMETERS	
	MIN	MAX	MIN	MAX
A	0.905	0.915	22.99	23.24
B	0.535	0.545	13.60	13.80
C	0.147	0.200	3.73	5.08
D	0.495	0.505	12.57	12.83
E	0.035	0.045	0.89	1.14
F	0.003	0.006	0.08	0.15
H	0.057	0.067	1.45	1.70
K	0.170	0.210	4.32	5.33
M	0.872	0.888	22.15	22.55
N	0.871	0.889	19.30	22.60
R	0.515	0.525	13.10	13.30
S	0.515	0.525	13.10	13.30
aaa	0.007 REF		0.178 REF	
bbb	0.010 REF		0.254 REF	
ccc	0.015 REF		0.381 REF	

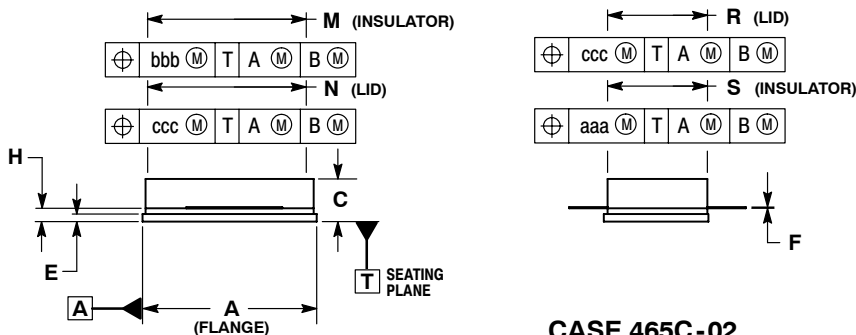

- STYLE 1:
 PIN 1. DRAIN
 2. GATE
 3. SOURCE

**CASE 465C-02
 ISSUE D
 NI-880S
 MRF19125SR3**

MRF19125R3 MRF19125SR3

How to Reach Us:

Home Page:
www.freescale.com

E-mail:
support@freescale.com

USA/Europe or Locations Not Listed:
Freescale Semiconductor
Technical Information Center, CH370
1300 N. Alma School Road
Chandler, Arizona 85224
+1-800-521-6274 or +1-480-768-2130
support@freescale.com

Europe, Middle East, and Africa:
Freescale Halbleiter Deutschland GmbH
Technical Information Center
Schatzbogen 7
81829 Muenchen, Germany
+44 1296 380 456 (English)
+46 8 52200080 (English)
+49 89 92103 559 (German)
+33 1 69 35 48 48 (French)
support@freescale.com

Japan:
Freescale Semiconductor Japan Ltd.
Headquarters
ARCO Tower 15F
1-8-1, Shimo-Meguro, Meguro-ku,
Tokyo 153-0064
Japan
0120 191014 or +81 3 5437 9125
support.japan@freescale.com

Asia/Pacific:
Freescale Semiconductor Hong Kong Ltd.
Technical Information Center
2 Dai King Street
Tai Po Industrial Estate
Tai Po, N.T., Hong Kong
+800 2666 8080
support.asia@freescale.com

For Literature Requests Only:
Freescale Semiconductor Literature Distribution Center
P.O. Box 5405
Denver, Colorado 80217
1-800-441-2447 or 303-675-2140
Fax: 303-675-2150
LDCForFreescaleSemiconductor@hibbertgroup.com

Information in this document is provided solely to enable system and software implementers to use Freescale Semiconductor products. There are no express or implied copyright licenses granted hereunder to design or fabricate any integrated circuits or integrated circuits based on the information in this document.

Freescale Semiconductor reserves the right to make changes without further notice to any products herein. Freescale Semiconductor makes no warranty, representation or guarantee regarding the suitability of its products for any particular purpose, nor does Freescale Semiconductor assume any liability arising out of the application or use of any product or circuit, and specifically disclaims any and all liability, including without limitation consequential or incidental damages. "Typical" parameters that may be provided in Freescale Semiconductor data sheets and/or specifications can and do vary in different applications and actual performance may vary over time. All operating parameters, including "Typicals", must be validated for each customer application by customer's technical experts. Freescale Semiconductor does not convey any license under its patent rights nor the rights of others. Freescale Semiconductor products are not designed, intended, or authorized for use as components in systems intended for surgical implant into the body, or other applications intended to support or sustain life, or for any other application in which the failure of the Freescale Semiconductor product could create a situation where personal injury or death may occur. Should Buyer purchase or use Freescale Semiconductor products for any such unintended or unauthorized application, Buyer shall indemnify and hold Freescale Semiconductor and its officers, employees, subsidiaries, affiliates, and distributors harmless against all claims, costs, damages, and expenses, and reasonable attorney fees arising out of, directly or indirectly, any claim of personal injury or death associated with such unintended or unauthorized use, even if such claim alleges that Freescale Semiconductor was negligent regarding the design or manufacture of the part.

Freescale™ and the Freescale logo are trademarks of Freescale Semiconductor, Inc. All other product or service names are the property of their respective owners.
© Freescale Semiconductor, Inc. 2006. All rights reserved.

