



## VERY LOW DROP VOLTAGE REGULATORS WITH INHIBIT

- VERY LOW DROPOUT VOLTAGE (0.2V TYP. AT 50mA LOAD)
- VERY LOW QUIESCENT CURRENT (TYP. 500 $\mu$ A AT 50mA LOAD)
- OUTPUT CURRENT UP TO 50mA
- LOGIC-CONTROLLED ELECTRONIC SHUTDOWN
- OUTPUT VOLTAGES OF 2.85; 3.0; 3.2; 3.3; 3.8; 5.0V
- INTERNAL CURRENT AND THERMAL LIMIT
- SUPPLY VOLTAGE REJECTION: 63dB (TYP)
- ONLY 1 $\mu$ F FOR STABILITY
- SELECTION AT 25°C
- TEMPERATURE RANGE: -25°C TO 125°C
- PACKAGE AVAILABLE: SOT23-5L AND TO-92

### DESCRIPTION

The LD2979 series are very Low Drop regulators available in SOT23-5L and TO-92.

The very low drop-voltage and the very low quiescent current make them particularly suitable for low noise, low power applications and in battery powered systems.

Shutdown Logic Control function is available on five pin version (TTL compatible). This means that

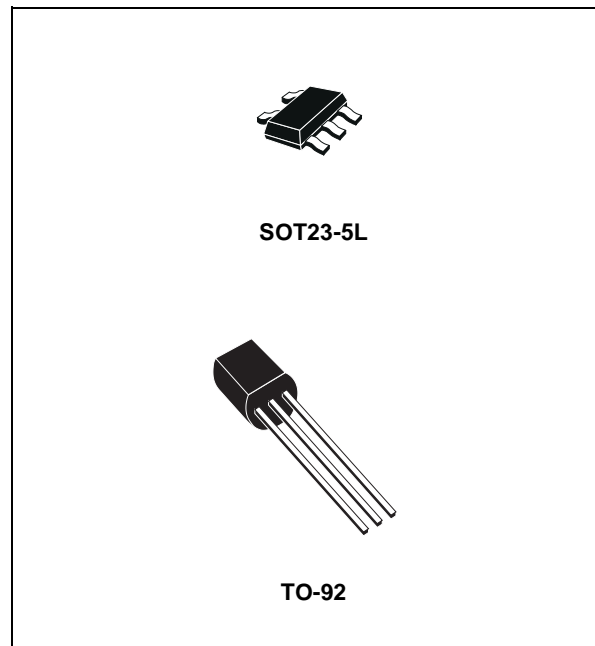

when the device is used as local regulator, it is possible to put a part of the board in standby, decreasing the total power consumption.

### SCHEMATIC DIAGRAM

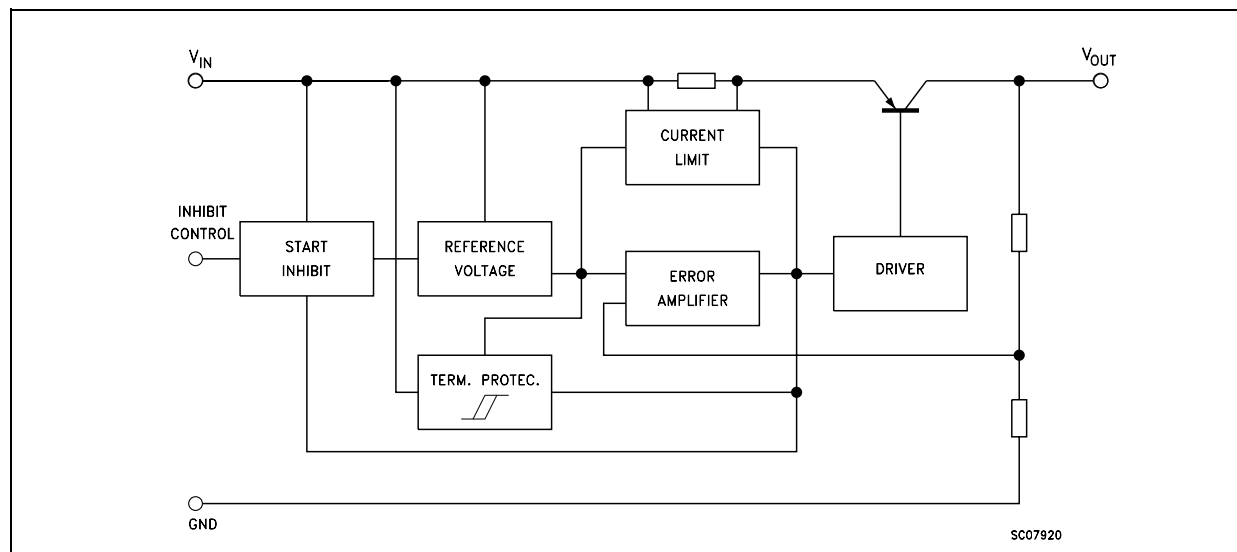

## LD2979 SERIES

### ABSOLUTE MAXIMUM RATINGS

Symbol	Parameter	Value	Unit
$V_I$	DC Input Voltage	16	V
$V_{INH}$	DC Inhibit Input Voltage	$V_{IN}$	V
$I_O$	Output Current	Internally limited	
$P_{tot}$	Power Dissipation	Internally limited	
$T_{stg}$	Storage Temperature Range	-40 to 150	°C
$T_{op}$	Operating Junction Temperature Range	-25 to 125	°C

Absolute Maximum Ratings are those values beyond which damage to the device may occur. Functional operation under these condition is not implied.

### CONNECTION DIAGRAM (top view)

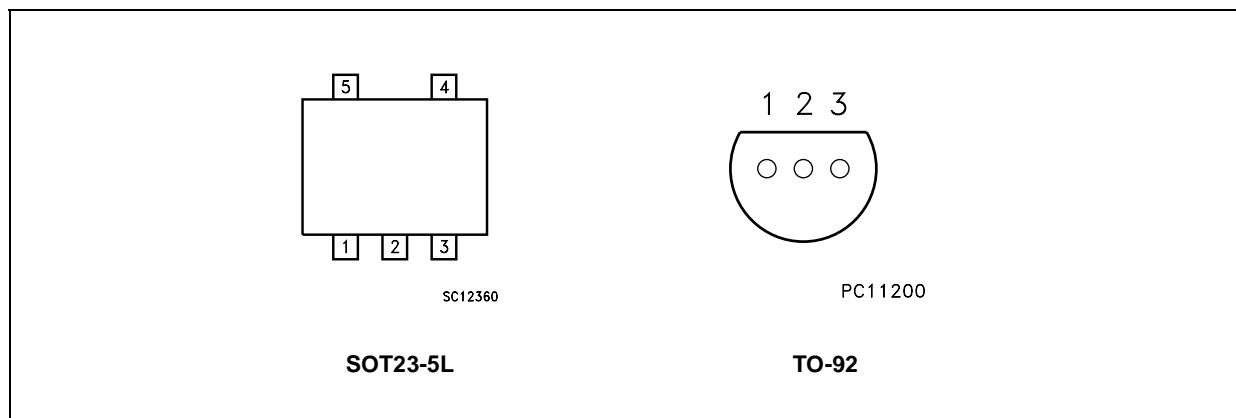

### PIN DESCRIPTION

SYMBOL	NAME AND FUNCTION	PIN NUMBER	
		SOT23-5L	TO-92
$V_{IN}$	Input Voltage	1	3
GND	Ground	2	2
INHIBIT	Control Switch ON/OFF (*)	3	
NC	Not to be connected	4	
$V_{OUT}$	Output Voltage	5	1

(\*) Only for the version in SOT23-5L package: Inhibit pin is not internally pulled-up then it must not be left floating. Connect to a positive voltage higher than 2V to able the device.

### ORDERING CODES

SOT23-5L (T&R)	TO-92	TO-92 (T&R)	TO-92 (Ammo Pack)	OUTPUT VOLTAGES
LD2979M28TR	LD2979Z28	LD2979Z28TR	LD2979Z28AP	2.85 V
LD2979M30TR	LD2979Z30	LD2979Z30TR	LD2979Z30AP	3.0 V
LD2979M32TR	LD2979Z32	LD2979Z32TR	LD2979Z32AP	3.2 V
LD2979M33TR	LD2979Z33	LD2979Z33TR	LD2979Z33AP	3.3 V
LD2979M38TR	LD2979Z38	LD2979Z38TR	LD2979Z38AP	3.8 V
LD2979M50TR	LD2979Z50	LD2979Z50TR	LD2979Z50AP	5.0 V

**ELECTRICAL CHARACTERISTICS FOR LD2979** (refer to the test circuits,  $T_a = 25^\circ\text{C}$ ,  $V_{IN} = V_{O(NOM)} + 1\text{V}$ ,  $I_O = 1\text{mA}$ ,  $V_{INH} = 2\text{V}^{(*)}$ ,  $C_O = 1\mu\text{F}$ ) (unless otherwise specified)

Symbol	Parameter	Test Conditions	Min.	Typ.	Max.	Unit
$V_O$	Output Voltage	$V_{IN} = 3.85\text{ V}$	2.793	2.85	2.907	V
		$I_O = 1\text{ to }50\text{mA}$ $T_a = -25\text{ to }125^\circ\text{C}$	2.736		2.964	
$V_O$	Output Voltage	$V_{IN} = 4\text{ V}$	2.940	3	3.060	V
		$I_O = 1\text{ to }50\text{mA}$ $T_a = -25\text{ to }125^\circ\text{C}$	2.880		3.120	
$V_O$	Output Voltage	$V_{IN} = 4.2\text{ V}$	3.136	3.2	3.264	V
		$I_O = 1\text{ to }50\text{mA}$ $T_a = -25\text{ to }125^\circ\text{C}$	3.072		3.328	
$V_O$	Output Voltage	$V_{IN} = 4.3\text{ V}$	3.234	3.3	3.366	V
		$I_O = 1\text{ to }50\text{mA}$ $T_a = -25\text{ to }125^\circ\text{C}$	3.168		3.432	
$V_O$	Output Voltage	$V_{IN} = 4.8\text{ V}$	3.724	3.8	3.876	V
		$I_O = 1\text{ to }50\text{mA}$ $T_a = -25\text{ to }125^\circ\text{C}$	3.648		3.952	
$V_O$	Output Voltage	$V_{IN} = 6\text{ V}$	4.9	5	5.1	V
		$I_O = 1\text{ to }50\text{mA}$ $T_a = -25\text{ to }125^\circ\text{C}$	4.8		5.2	
$I_{out}$	Output Current Limit		100			mA
$\Delta V_O$	Line Regulation	$V_{IN} = V_{O(NOM)} + 1\text{V to }16\text{V}$ , $I_O = 1\text{mA}$			0.028	%/ $V_{IN}$
		$T_a = -25\text{ to }125^\circ\text{C}$			0.064	
$I_d$	Quiescent Current (On Mode)	$I_O = 0$		80	110	$\mu\text{A}$
		$I_O = 0$ $T_a = -25\text{ to }125^\circ\text{C}$			170	
		$I_O = 50\text{mA}$		500	700	
		$I_O = 50\text{mA}$ $T_a = -25\text{ to }125^\circ\text{C}$			1300	
$I_d$	Quiescent Current (Off Mode) (*)	$V_{INH} < 0.18\text{ V}$		0		$\mu\text{A}$
		$V_{INH} < 0.18\text{ V}$ $T_a = -25\text{ to }125^\circ\text{C}$			1	
SVR	Supply Voltage Rejection	$I_O = 50\text{mA}$ $C_{OUT} = 10\mu\text{F}$ $f = 120\text{Hz}$		63		dB
$V_d$	Dropout Voltage	$I_O = 0$		6	12	mV
		$I_O = 0$ $T_a = -25\text{ to }125^\circ\text{C}$			18	
		$I_O = 1\text{mA}$		30	60	
		$I_O = 1\text{mA}$ $T_a = -25\text{ to }125^\circ\text{C}$			90	
		$I_O = 10\text{mA}$		100	200	
		$I_O = 10\text{mA}$ $T_a = -25\text{ to }125^\circ\text{C}$			300	
		$I_O = 50\text{mA}$		200	400	
		$I_O = 50\text{mA}$ $T_a = -25\text{ to }125^\circ\text{C}$			600	
$V_{IL}$	Inhibit Input Logic Low	Device Off $T_a = -25\text{ to }125^\circ\text{C}$ (*)			0.18	V
$V_{IH}$	Inhibit Input Logic High	Device On $T_a = -25\text{ to }125^\circ\text{C}$ (*)	2			V
$I_I$	Inhibit Input Current	$V_{INH} = 0\text{ V}$ (*)		0	-1	$\mu\text{A}$
		$V_{INH} = 5\text{ V}$ $T_a = -25\text{ to }125^\circ\text{C}$		5	15	
eN	Output Noise Voltage (RMS)	$\text{BW} = 300\text{Hz to }50\text{KHz}$ $C_O = 10\mu\text{F}$		160		$\mu\text{V}$

(\*) Note: Only for types in SOT23-5L

TYPICAL CHARACTERISTICS (unless otherwise specified  $T_a = 25^\circ\text{C}$ )

Figure 1 : Output Voltage vs Temperature

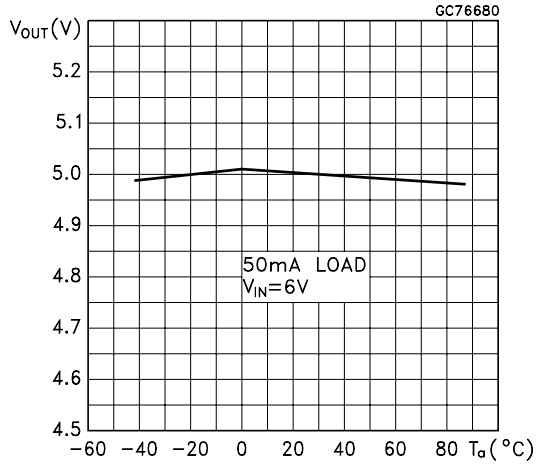

Figure 2 : Output Voltage vs Input Voltage

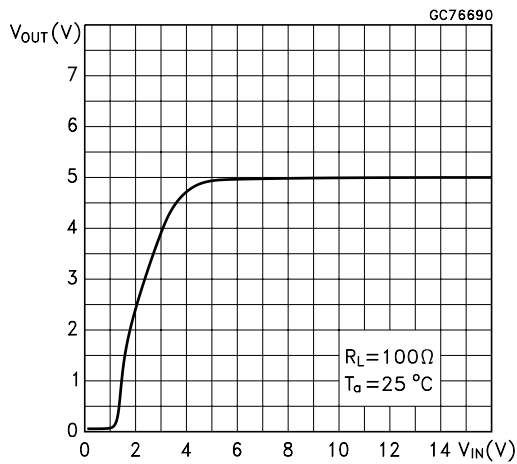

Figure 3 : Output Voltage vs Input Voltage

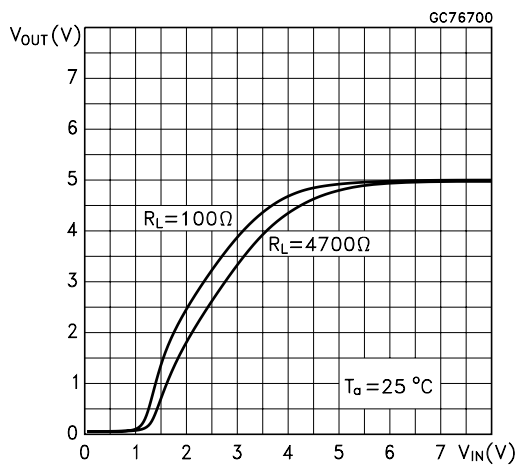

Figure 4 : Dropout Voltage vs Output Current

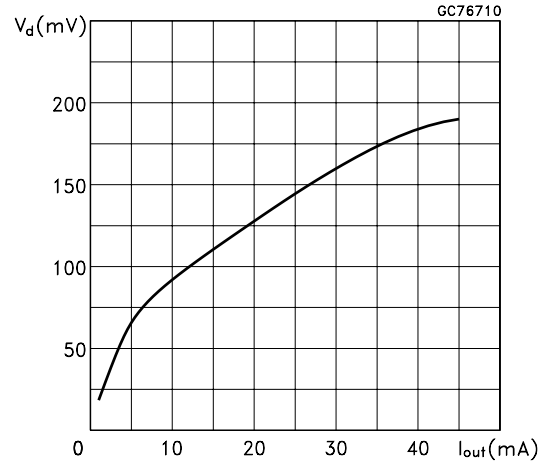

Figure 5 : Dropout Voltage vs Temperature

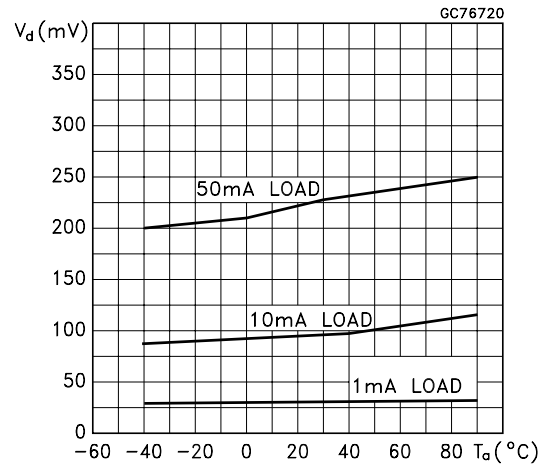
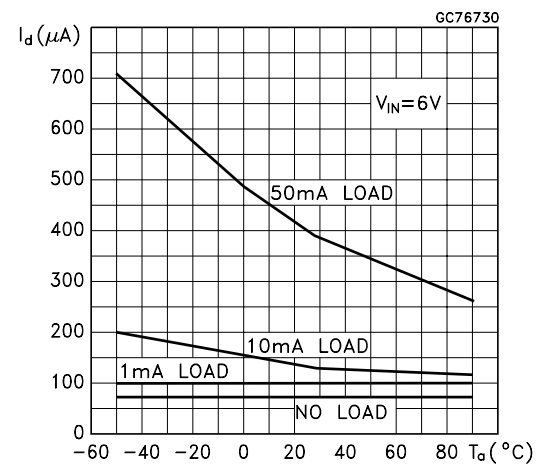
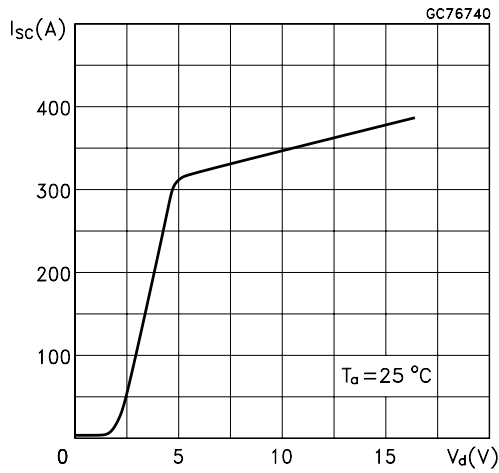

Figure 6 : Quiescent Current vs Temperature



**Figure 7 : Short Circuit Current vs Dropout Voltage**



**Figure 10 : Inhibit Voltage vs Temperature**

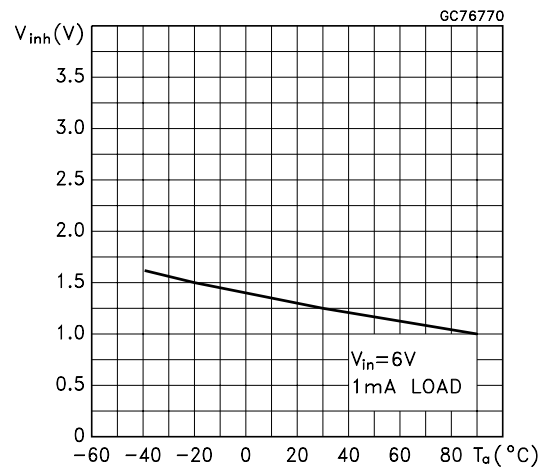

**Figure 8 : Supply Voltage Rejection vs Frequency**

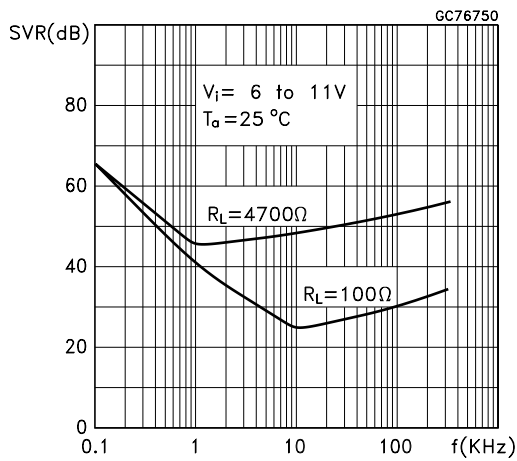

**Figure 11 : Load Transient Response**

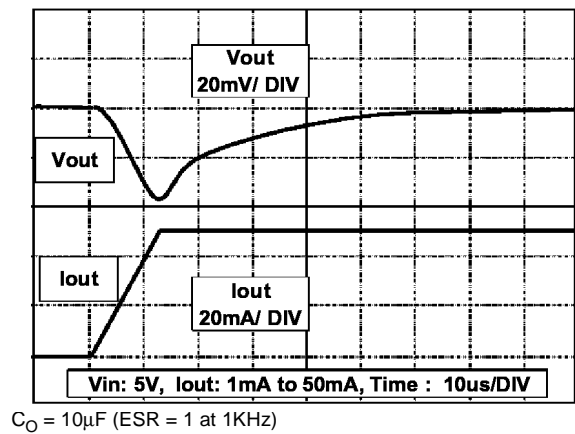

**Figure 9 : Inhibit Current vs Temperature**

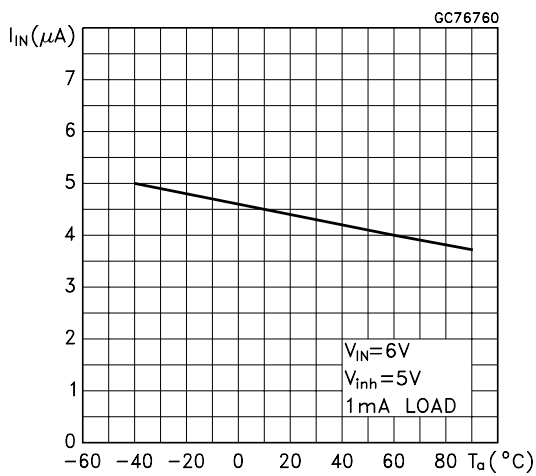

**Figure 12 : Load Transient Response**

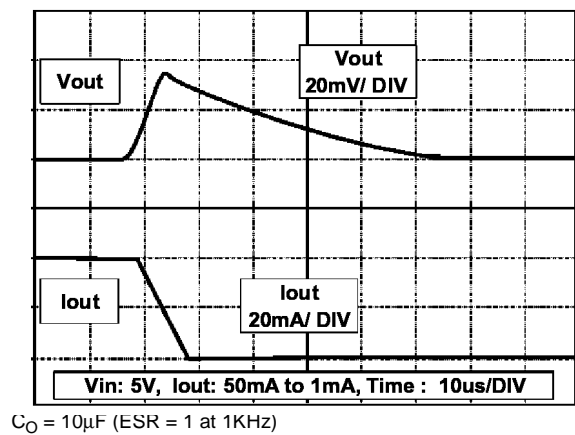
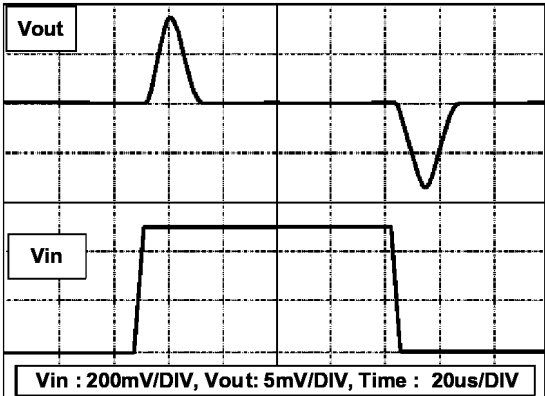

Figure 13 : Line Transient Response



$C_O = 10\mu\text{F}$  (ESR = 1 at 1KHz)

## SOT23-5L MECHANICAL DATA

DIM.	mm.			mils		
	MIN.	TYP	MAX.	MIN.	TYP.	MAX.
A	0.90		1.45	35.4		57.1
A1	0.00		0.15	0.0		5.9
A2	0.90		1.30	35.4		51.2
b	0.35		0.50	13.7		19.7
C	0.09		0.20	3.5		7.8
D	2.80		3.00	110.2		118.1
E	2.60		3.00	102.3		118.1
E1	1.50		1.75	59.0		68.8
e		0.95			37.4	
e1		1.9			74.8	
L	0.35		0.55	13.7		21.6

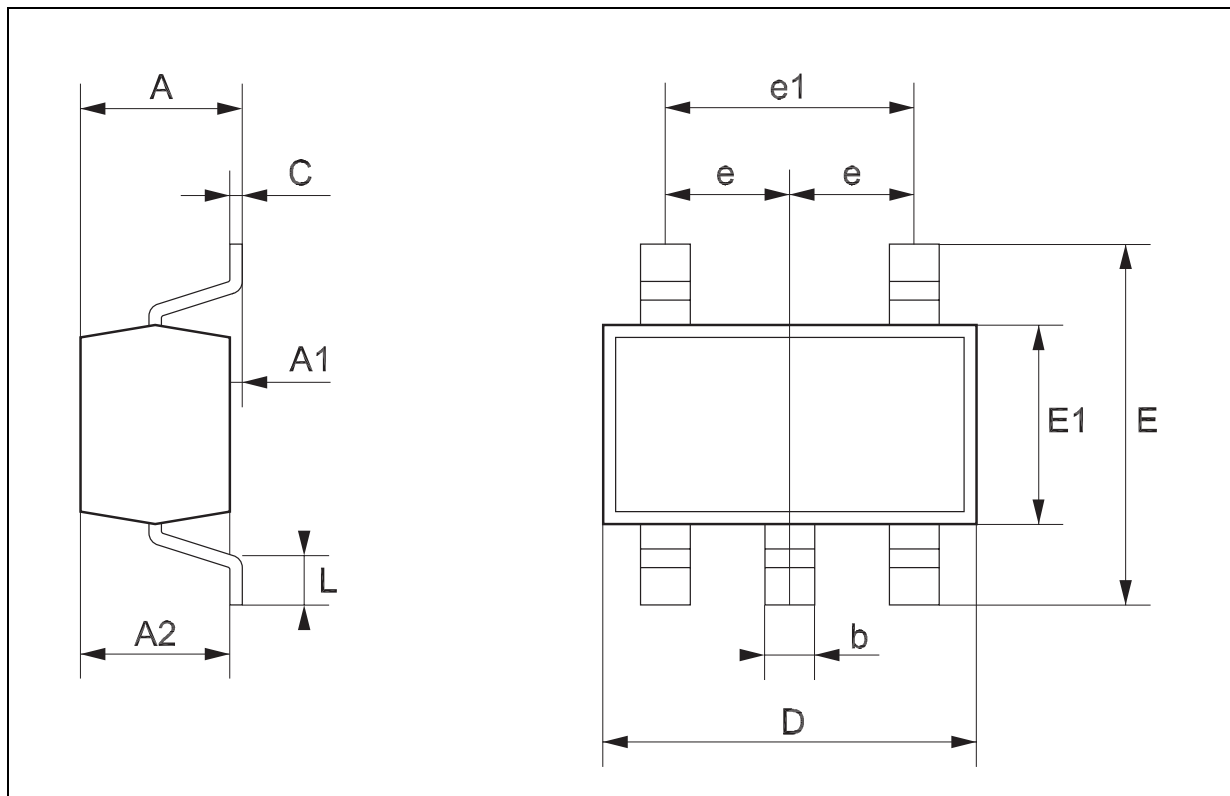

**TO-92 MECHANICA DATA**

DIM.	mm.			mils		
	MIN.	TYP	MAX.	MIN.	TYP.	MAX.
A	4.32		4.95	170.1		194.9
b	0.36		0.51	14.2		20.1
D	4.45		4.95	175.2		194.9
E	3.30		3.94	129.9		155.1
e	2.41		2.67	94.9		105.1
e1	1.14		1.40	44.9		55.1
L	12.7		15.49	500.0		609.8
R	2.16		2.41	85.0		94.9
S1	0.92		1.52	36.2		59.8
W	0.41		0.56	16.1		22.0

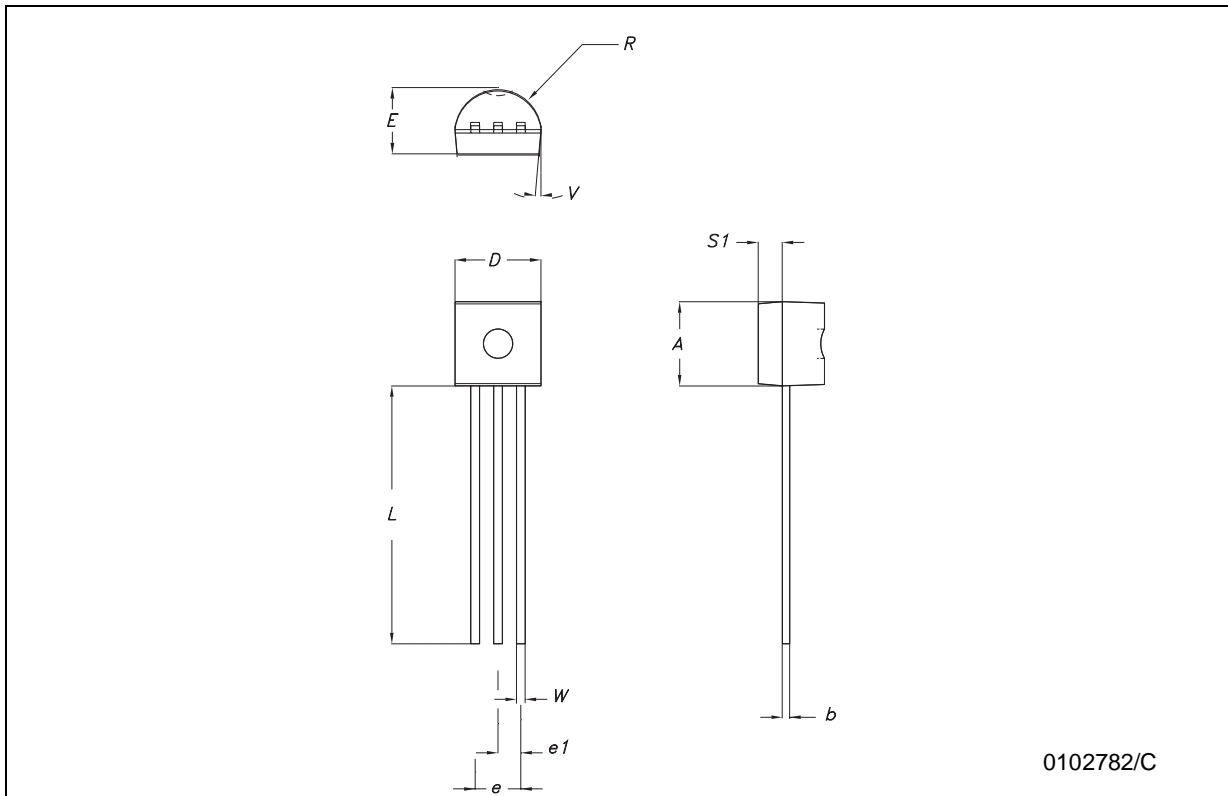

0102782/C



## Tape &amp; Reel SOT23-xL MECHANICAL DATA

DIM.	mm.			inch		
	MIN.	TYP	MAX.	MIN.	TYP.	MAX.
A			180			7.086
C	12.8	13.0	13.2	0.504	0.512	0.519
D	20.2			0.795		
N	60			2.362		
T			14.4			0.567
Ao	3.13	3.23	3.33	0.123	0.127	0.131
Bo	3.07	3.17	3.27	0.120	0.124	0.128
Ko	1.27	1.37	1.47	0.050	0.054	0.058
Po	3.9	4.0	4.1	0.153	0.157	0.161
P	3.9	4.0	4.1	0.153	0.157	0.161

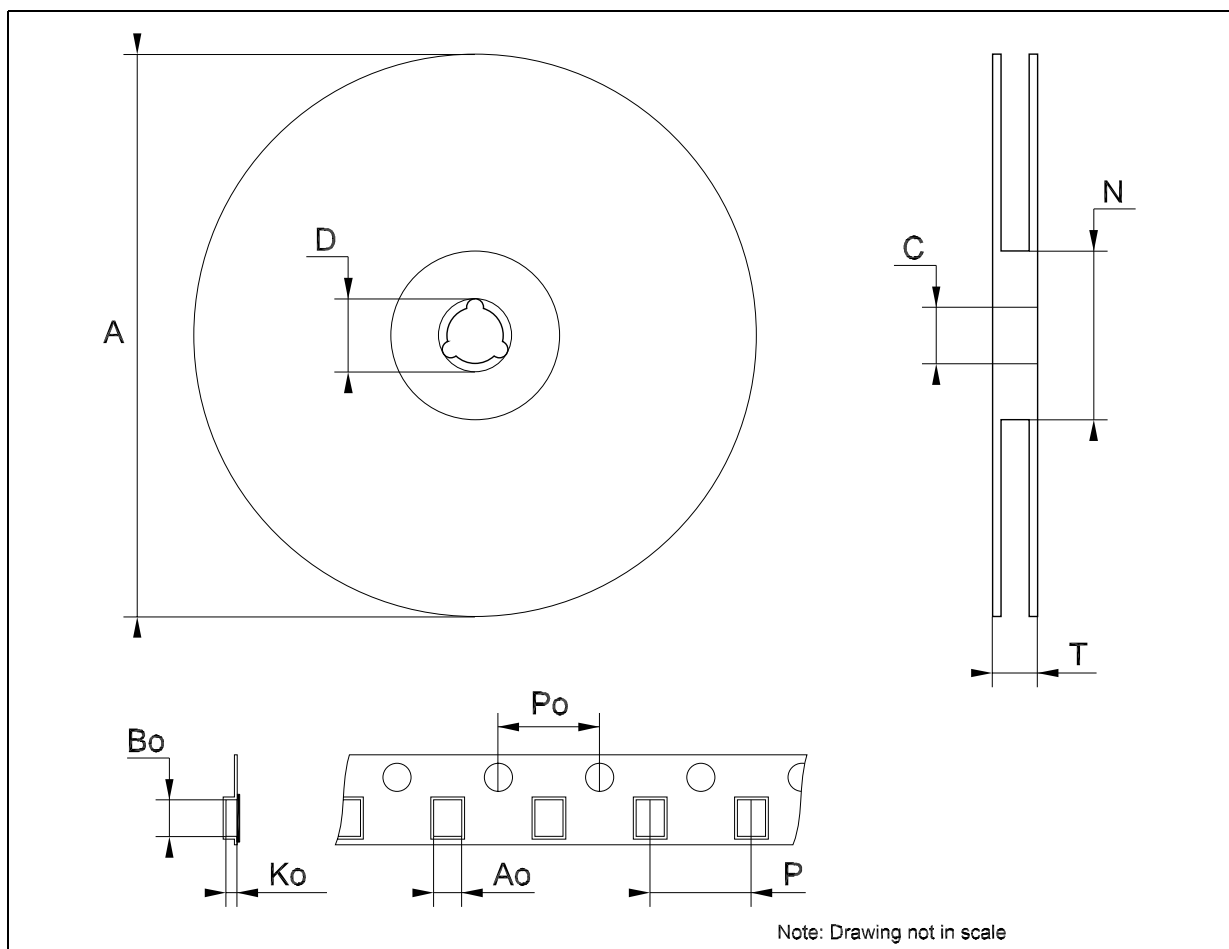

Information furnished is believed to be accurate and reliable. However, STMicroelectronics assumes no responsibility for the consequences of use of such information nor for any infringement of patents or other rights of third parties which may result from its use. No license is granted by implication or otherwise under any patent or patent rights of STMicroelectronics. Specifications mentioned in this publication are subject to change without notice. This publication supersedes and replaces all information previously supplied. STMicroelectronics products are not authorized for use as critical components in life support devices or systems without express written approval of STMicroelectronics.

© The ST logo is a registered trademark of STMicroelectronics

© 2003 STMicroelectronics - Printed in Italy - All Rights Reserved  
STMicroelectronics GROUP OF COMPANIES

Australia - Brazil - Canada - China - Finland - France - Germany - Hong Kong - India - Israel - Italy - Japan - Malaysia - Malta - Morocco  
Singapore - Spain - Sweden - Switzerland - United Kingdom - United States.

© <http://www.st.com>