



MJD122-1 / MJD122T4 MJD127-1 / MJD127T4

COMPLEMENTARY POWER DARLINGTON TRANSISTORS

Ordering Code	Marking	Package	Shipment
MJD122T4	MJD122	TO-252 (DPAK)	Tape & Reel
MJD122-1	MJD122	TO-251 (IPAK)	Tube
MJD127T4	MJD127	TO-252 (DPAK)	Tape & Reel
MJD127-1	MJD127	TO-251 (IPAK)	Tube

- STMicroelectronics PREFERRED SALESTYPES
- LOW BASE-DRIVE REQUIREMENTS
- INTEGRATED ANTIPARALLEL COLLECTOR-EMITTER DIODE
- THROUGH HOLE TO-251 (IPAK) POWER PACKAGE IN TUBE (SUFFIX "-1")
- SURFACE MOUNTING TO-252 (DPAK) POWER PACKAGE IN TAPE & REEL (SUFFIX "T4")
- ELECTRICALLY SIMILAR TO TIP122 AND TIP127

APPLICATIONS:

- GENERAL PURPOSE SWITCHING AND AMPLIFIER

DESCRIPTION

The MJD122 and MJD127 form complementary NPN - PNP pair. They are manufactured using Epitaxial Base technology for cost-effective performance.

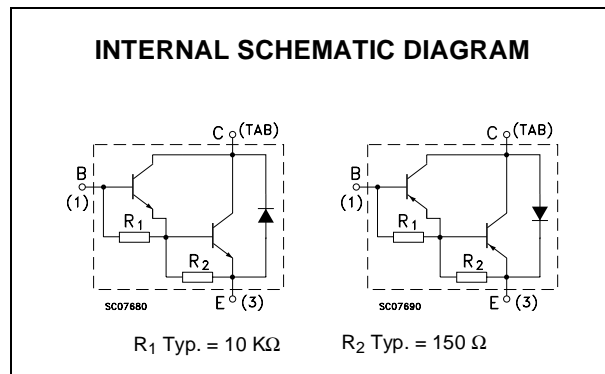
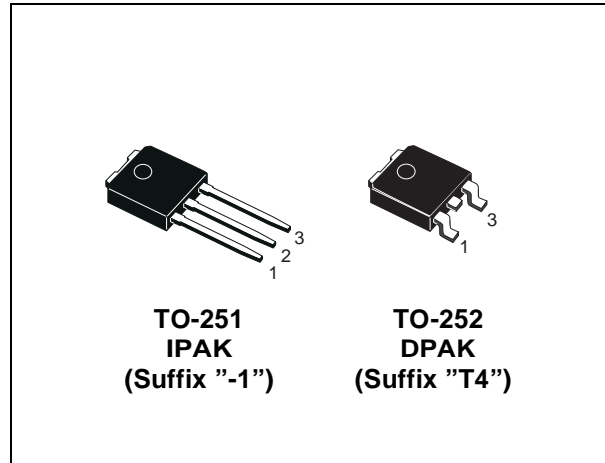

ABSOLUTE MAXIMUM RATINGS

Symbol	Parameter	Value		Unit
		NPN	MJD122	
		PNP	MJD127	
V_{CBO}	Collector-Base Voltage ($I_E = 0$)		100	V
V_{CEO}	Collector-Emitter Voltage ($I_B = 0$)		100	V
V_{EBO}	Emitter-Base Voltage ($I_C = 0$)		5	V
I_C	Collector Current		5	A
I_{CM}	Collector Peak Current ($t_p < 5$ ms)		8	A
I_B	Base Current		0.1	A
P_{tot}	Total Dissipation at $T_c = 25$ °C		20	W
T_{stg}	Storage Temperature		-65 to 150	°C
T_j	Max. Operating Junction Temperature		150	°C

For PNP types voltage and current values are negative.

MJD122-1 / MJD122T4 / MJD127-1 / MJD127T4

THERMAL DATA

R _{thj-case}	Thermal Resistance Junction-case	Max	6.25	°C/W
R _{thj-amb}	Thermal Resistance Junction-ambient	Max	100	°C/W

ELECTRICAL CHARACTERISTICS (T_j = 25 °C unless otherwise specified)

Symbol	Parameter	Test Conditions	Min.	Typ.	Max.	Unit
I _{CBO}	Collector Cut-off Current (I _E = 0)	V _{CB} = 100 V			10	μA
I _{CEO}	Collector Cut-off Current (I _B = 0)	V _{CE} = 50 V			10	μA
I _{CEX}	Collector Cut-off Current (V _{BE} = -1.5 V)	V _{CE} = 100 V V _{CE} = 100 V T _j = 125 °C			10 500	μA μA
I _{EBO}	Emitter Cut-off Current (I _C = 0)	V _{EB} = 5 V			2	mA
V _{CEO(sus)} *	Collector-Emitter Sustaining Voltage (I _B = 0)	I _C = 30 mA	100			V
V _{CE(sat)} *	Collector-Emitter Saturation Voltage	I _C = 4 A I _B = 16 mA I _C = 8 A I _B = 80 mA			2 4	V V
V _{BE(sat)} *	Base-Emitter Saturation Voltage	I _C = 8 A I _B = 80 mA			4.5	V
V _{BE(on)} *	Base-Emitter On Voltage	I _C = 4 A V _{CE} = 4 V			2.8	V
h _{FE} *	DC Current Gain	I _C = 4 A V _{CE} = 4 V I _C = 8 A V _{CE} = 4 V	1000 100		12000	

* Pulsed: Pulse duration = 300 μs, duty cycle ≤ 2 %.
For PNP types voltage and current values are negative.

Safe Operating Area

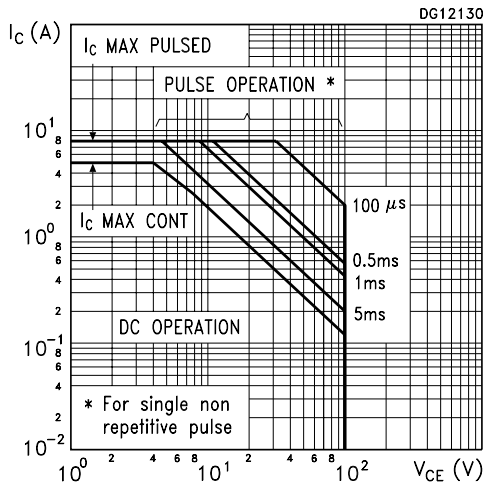

Derating Curve

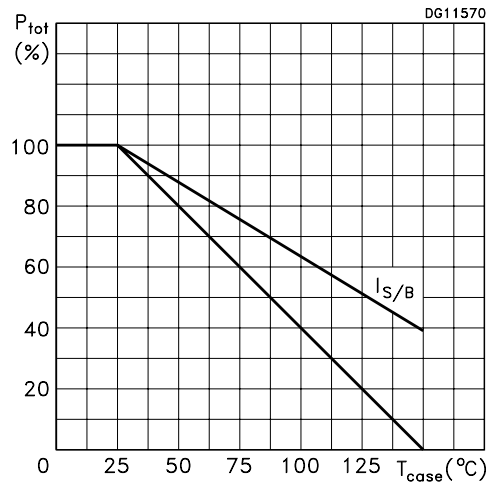

Collector-Emitter Saturation Voltage (NPN type)

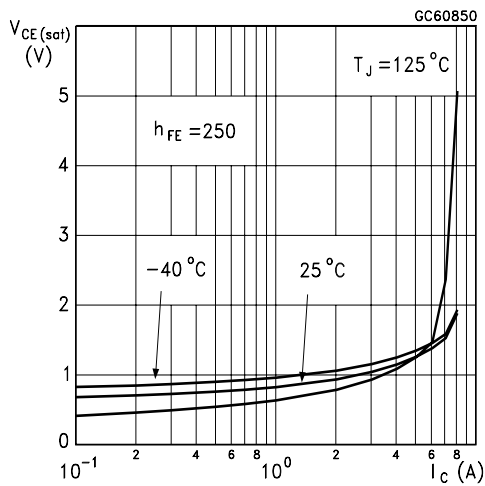

Collector-Emitter Saturation Voltage (PNP type)

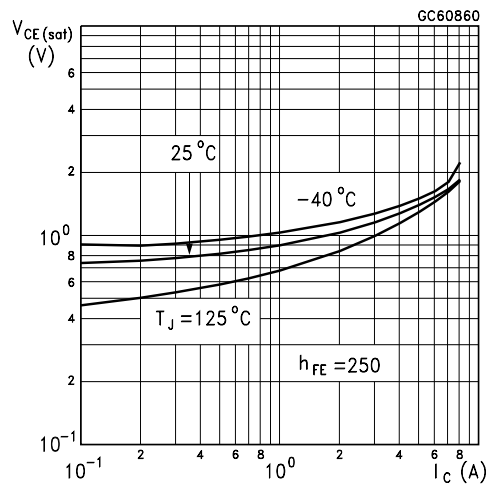

Base-Emitter Saturation Voltage (NPN type)

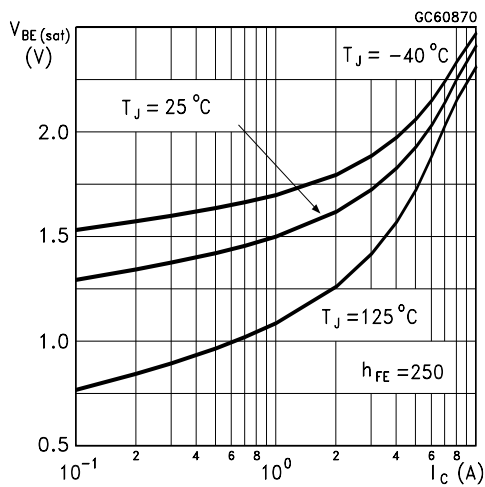

Base-Emitter Saturation Voltage (PNP type)

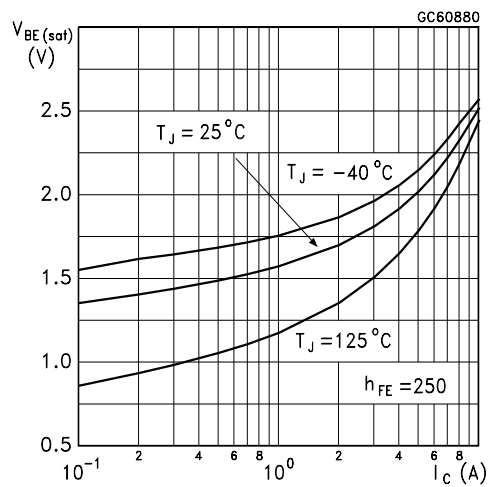

Base-Emitter On Voltage (NPN type)

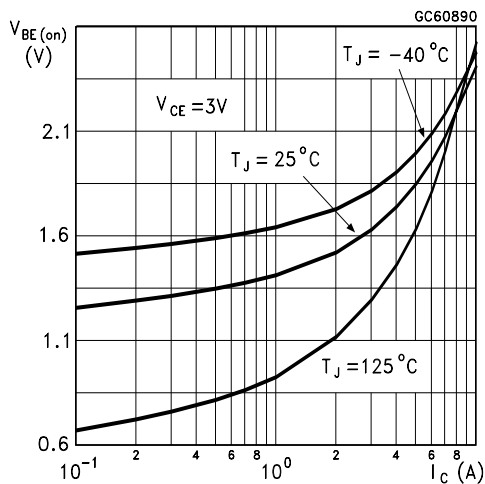

Base-Emitter On Voltage (PNP type)

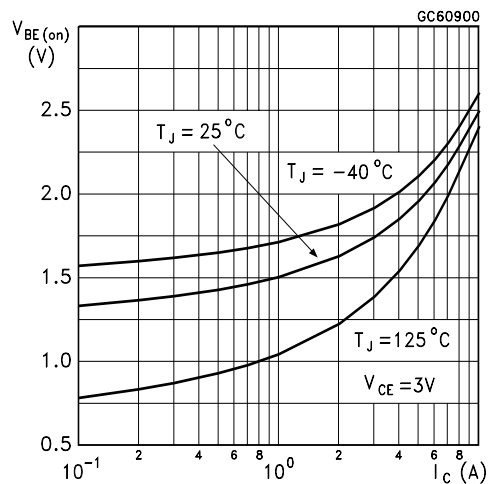

DC Current Gain (NPN type)

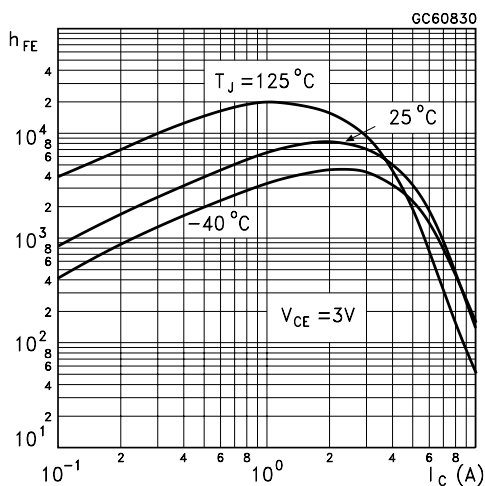

DC Current Gain (PNP type)

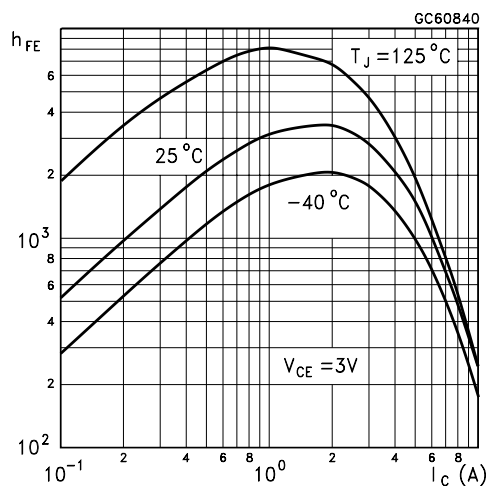

Switching Times Resistive Load (NPN type)

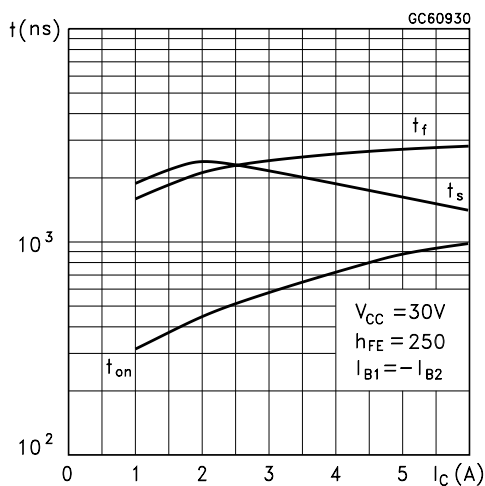

Switching Times Resistive Load (PNP type)

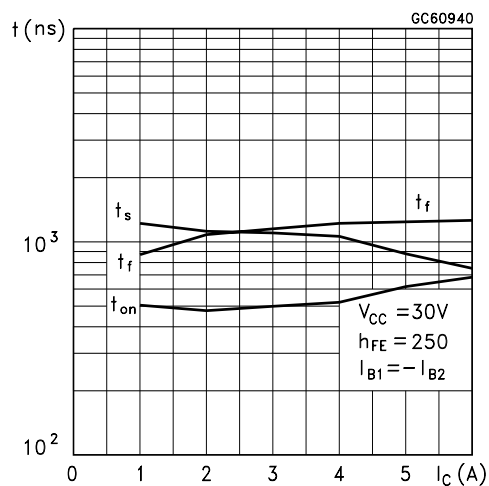

Freewheel Diode Forward Voltage (NPN type)

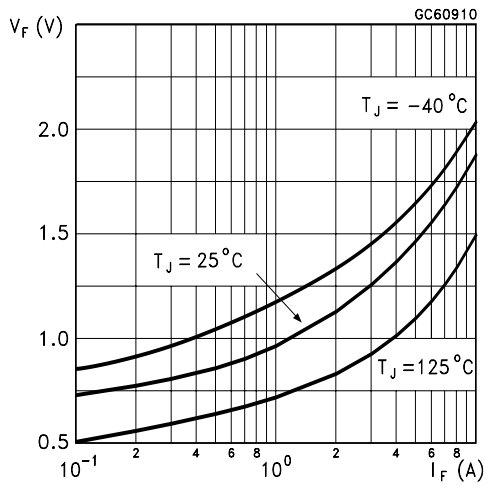

Freewheel Diode Forward Voltage (PNP type)

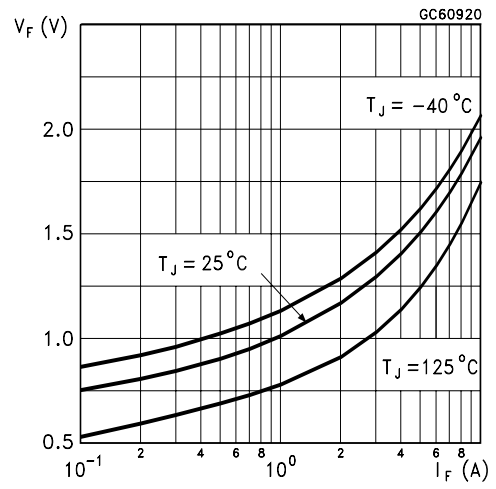

TO-251 (IPAK) MECHANICAL DATA

DIM.	mm			inch		
	MIN.	TYP.	MAX.	MIN.	TYP.	MAX.
A	2.20		2.40	0.087		0.094
A1	0.90		1.10	0.035		0.043
A3	0.70		1.30	0.028		0.051
B	0.64		0.90	0.025		0.035
B2	5.20		5.40	0.204		0.213
B3			0.85			0.033
B5		0.30			0.012	
B6			0.95			0.037
C	0.45		0.60	0.018		0.024
C2	0.48		0.60	0.019		0.024
D	6.00		6.20	0.237		0.244
E	6.40		6.60	0.252		0.260
G	4.40		4.60	0.173		0.181
H	15.90		16.30	0.626		0.642
L	9.00		9.40	0.354		0.370
L1	0.80		1.20	0.031		0.047
L2		0.80	1.00		0.031	0.039
V1		10°			10°	

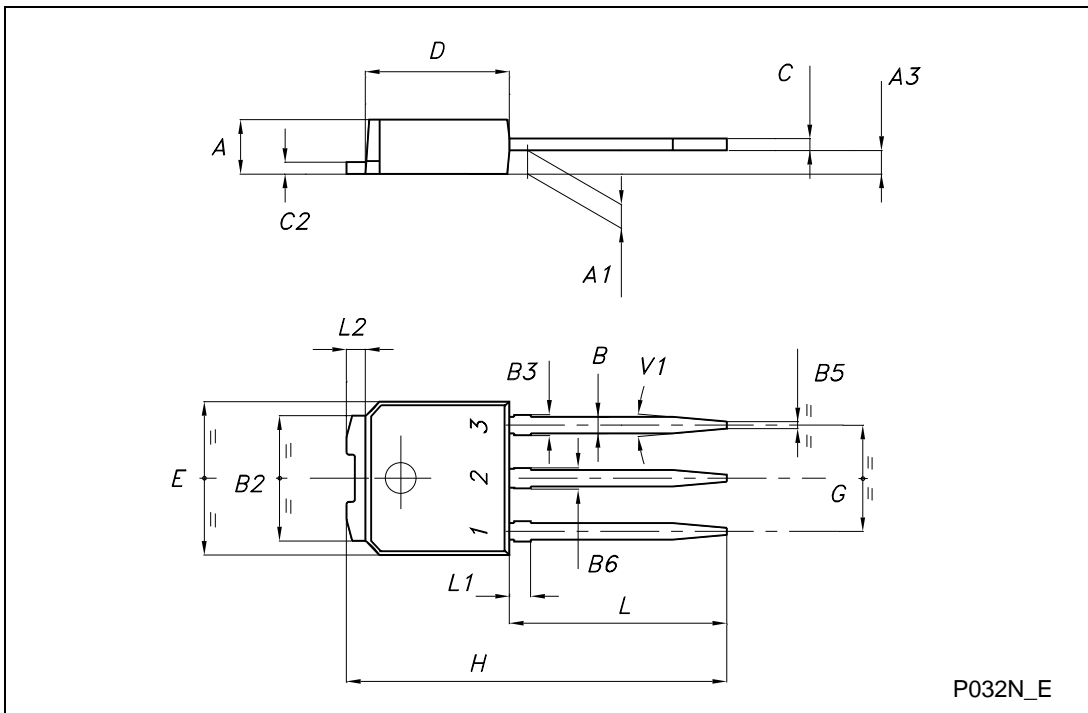

TO-252 (DPAK) MECHANICAL DATA

DIM.	mm			inch		
	MIN.	TYP.	MAX.	MIN.	TYP.	MAX.
A	2.20		2.40	0.087		0.094
A1	0.90		1.10	0.035		0.043
A2	0.03		0.23	0.001		0.009
B	0.64		0.90	0.025		0.035
B2	5.20		5.40	0.204		0.213
C	0.45		0.60	0.018		0.024
C2	0.48		0.60	0.019		0.024
D	6.00		6.20	0.236		0.244
E	6.40		6.60	0.252		0.260
G	4.40		4.60	0.173		0.181
H	9.35		10.10	0.368		0.398
L2		0.8			0.031	
L4	0.60		1.00	0.024		0.039
V2	0°		8°	0°		0°

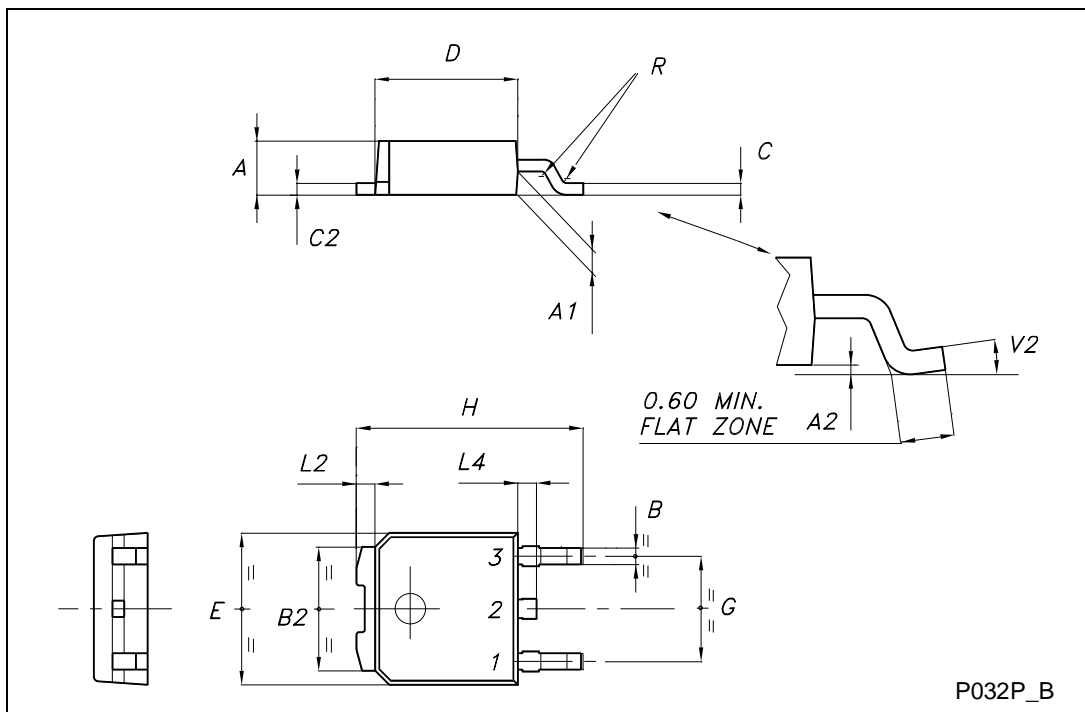

Information furnished is believed to be accurate and reliable. However, STMicroelectronics assumes no responsibility for the consequences of use of such information nor for any infringement of patents or other rights of third parties which may result from its use. No license is granted by implication or otherwise under any patent or patent rights of STMicroelectronics. Specifications mentioned in this publication are subject to change without notice. This publication supersedes and replaces all information previously supplied. STMicroelectronics products are not authorized for use as critical components in life support devices or systems without express written approval of STMicroelectronics.

© The ST logo is a registered trademark of STMicroelectronics

© 2002 STMicroelectronics - Printed in Italy - All Rights Reserved
STMicroelectronics GROUP OF COMPANIES

Australia - Brazil - Canada - China - Finland - France - Germany - Hong Kong - India - Israel - Italy - Japan - Malaysia - Malta - Morocco
Singapore - Spain - Sweden - Switzerland - United Kingdom - United States.

© <http://www.st.com>