



360mW MONO AMPLIFIER WITH STANDBY MODE

- **OPERATING FROM $V_{CC}=2V$ to 5.5V**
- **STANDBY MODE ACTIVE HIGH** (TS419) or LOW (TS421)
- **OUTPUT POWER** into 16 Ω : 367mW @ 5V with 10% THD+N max or 295mW @5V and 110mW @3.3V with 1% THD+N max.
- **LOW CURRENT CONSUMPTION:** 2.5mA max
- High Signal-to-Noise ratio: 95dB(A) at 5V
- PSRR: 56dB typ. at 1kHz, 46dB at 217Hz
- **SHORT CIRCUIT LIMITATION**
- ON/OFF click reduction circuitry
- Available in SO8, MiniSO8 & DFN 3x3

DESCRIPTION

The TS419/TS421 is a monaural audio power amplifier driving in BTL mode a 16 or 32 Ω earpiece or receiver speaker. The main advantage of this configuration is to get rid of bulky output capacitors. Capable of descending to low voltages, it delivers up to 220mW per channel (into 16 Ω loads) of continuous average power with 0.2% THD+N in the audio bandwidth from a 5V power supply. An externally controlled standby mode reduces the supply current to 10nA (typ.). The TS419/TS421 can be configured by external gain-setting resistors or used in a fixed gain version.

APPLICATIONS

- 16/32 ohms earpiece or receiver speaker driver
- Mobile and cordless phones (analog / digital)
- PDAs & computers
- Portable appliances

ORDER CODE

Part Number	Temp. Range: I	Package			Gain	Marking	
		D	S	Q			
TS419	-40, +85°C	•			external	TS419I	
TS421		•			external	TS421I	
TS419			•	•		external	K19A
TS419-2		tba	tba		x2/6dB		K19B
TS419-4		tba	tba		x4/12dB		K19C
TS419-8		tba	tba		x8/18dB		K19D
TS421			•	•		external	K21A
TS421-2		tba	tba		x2/6dB		K21B
TS421-4		tba	tba		x4/12dB		K21C
TS421-8		tba	tba		x8/18dB		K21D

MiniSO & DFN only available in Tape & Reel with T suffix.
SO is available in Tube (D) and in Tape & Reel (DT)

PIN CONNECTIONS (top view)

TS419IDT: SO8
TS419IST, TS419-xIST: MiniSO8

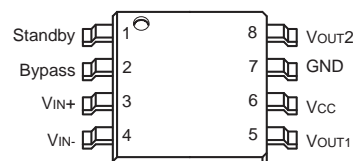

TS419IQT, TS419-xIQT: DFN8

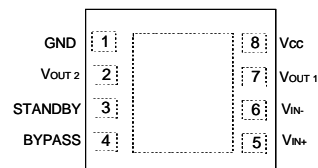

TS421IDT: SO8
TS421IST, TS421-xIST: MiniSO8

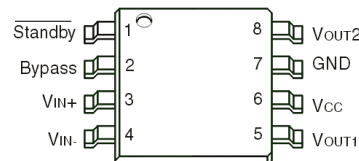

TS421IQT, TS421-xIQT: DFN8

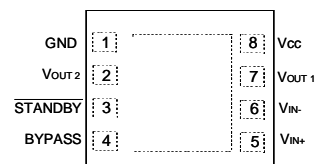

ABSOLUTE MAXIMUM RATINGS

Symbol	Parameter	Value	Unit
V _{CC}	Supply voltage ¹⁾	6	V
V _i	Input Voltage	-0.3V to V _{CC} +0.3V	V
T _{stg}	Storage Temperature	-65 to +150	°C
T _j	Maximum Junction Temperature	150	°C
R _{thja}	Thermal Resistance Junction to Ambient SO8 MiniSO8 DFN8	175 215 70	°C/W
Pd	Power Dissipation ²⁾ SO8 MiniSO8 DFN8	0.71 0.58 1.79	W
ESD	Human Body Model (pin to pin): TS419 ³⁾ , TS421	1.5	kV
ESD	Machine Model - 220pF - 240pF (pin to pin)	100	V
Latch-up	Latch-up Immunity (All pins)	200	mA
	Lead Temperature (soldering, 10sec)	250	°C
	Output Short-Circuit to V _{CC} or GND	continuous ⁴⁾	

1. All voltage values are measured with respect to the ground pin.
2. Pd has been calculated with T_{amb} = 25°C, T_{junction} = 150°C.
3. TS419 stands 1.5KV on all pins except standby pin which stands 1KV.
4. Attention must be paid to continuous power dissipation (V_{DD} x 300mA). Exposure of the IC to a short circuit for an extended time period is dramatically reducing product life expectancy.

OPERATING CONDITIONS

Symbol	Parameter	Value	Unit
V _{CC}	Supply Voltage	2 to 5.5	V
R _L	Load Resistor	≥ 16	Ω
T _{oper}	Operating Free Air Temperature Range	-40 to + 85	°C
C _L	Load Capacitor R _L = 16 to 100Ω R _L > 100Ω	400 100	pF
V _{ICM}	Common Mode Input Voltage Range	GND to V _{CC} -1V	V
V _{STB}	Standby Voltage Input TS421 ACTIVE / TS419 in STANDBY TS421 in STANDBY / TS419 ACTIVE	1.5 ≤ V _{STB} ≤ V _{CC} GND ≤ V _{STB} ≤ 0.4 ¹⁾	V
R _{THJA}	Thermal Resistance Junction to Ambient SO8 MiniSO8 DFN8 ²⁾	150 190 41	°C/W
T _{wu}	Wake-up time from standby to active mode (Cb = 1μF) ³⁾	≥ 0.12	s

1. The minimum current consumption (I_{STANDBY}) is guaranteed at V_{CC} (TS419) or GND (TS421) for the whole temperature range.
2. When mounted on a 4-layer PCB
3. For more details on T_{wu}, please refer to application note section on Wake-up time page 28.

FIXED GAIN VERSION SPECIFIC ELECTRICAL CHARACTERISTICS

V_{CC} from +5V to +2V, GND = 0V, T_{amb} = 25°C (unless otherwise specified)

Symbol	Parameter	Min.	Typ.	Max.	Unit
R _{IN}	Input Resistance		20		kΩ
G	Gain value for Gain TS419/TS421-2		6dB		dB
	Gain value for Gain TS419/TS421-4		12dB		
	Gain value for Gain TS419/TS421-8		18dB		

APPLICATION COMPONENTS INFORMATION

Components	Functional Description
R _{IN}	Inverting input resistor which sets the closed loop gain in conjunction with R _{FEED} . This resistor also forms a high pass filter with C _{IN} (f _{cl} = 1 / (2 x Pi x R _{IN} x C _{IN})). Not needed in fixed gain versions.
C _{IN}	Input coupling capacitor which blocks the DC voltage at the amplifier's input terminal
R _{FEED}	Feedback resistor which sets the closed loop gain in conjunction with R _{IN} . A _V = Closed Loop Gain= 2xR _{FEED} /R _{IN} . Not needed in fixed gain versions.
C _S	Supply Bypass capacitor which provides power supply filtering.
C _B	Bypass capacitor which provides half supply filtering.

TYPICAL APPLICATION SCHEMATICS:

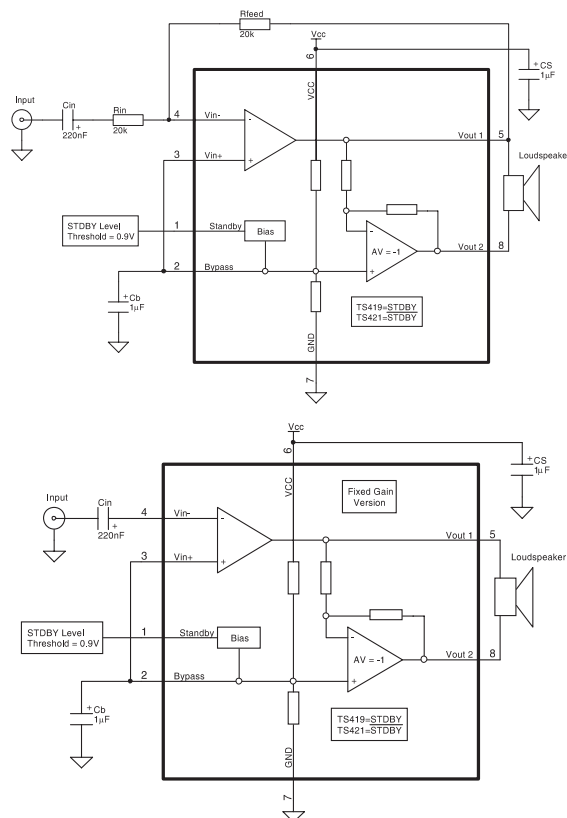

ELECTRICAL CHARACTERISTICS
 $V_{CC} = +5V$, $GND = 0V$, $T_{amb} = 25^{\circ}C$ (unless otherwise specified)

Symbol	Parameter	Min.	Typ.	Max.	Unit
I_{CC}	Supply Current No input signal, no load		1.8	2.5	mA
$I_{STANDBY}$	Standby Current No input signal, $V_{STANDBY}=GND$ for TS421 No input signal, $V_{STANDBY}=V_{CC}$ for TS419		10	1000	nA
V_{OO}	Output Offset Voltage No input signal, $R_L = 16$ or 32Ω , $R_{feed}=20k\Omega$		5	25	mV
P_O	Output Power THD+N = 0.1% Max, $F = 1kHz$, $R_L = 32\Omega$ THD+N = 1% Max, $F = 1kHz$, $R_L = 32\Omega$ THD+N = 10% Max, $F = 1kHz$, $R_L = 32\Omega$ THD+N = 0.1% Max, $F = 1kHz$, $R_L = 16\Omega$ THD+N = 1% Max, $F = 1kHz$, $R_L = 16\Omega$ THD+N = 10% Max, $F = 1kHz$, $R_L = 16\Omega$	166 240	190 207 258 270 295 367		mW
THD + N	Total Harmonic Distortion + Noise ($A_v=2$) $R_L = 32\Omega$, $P_{out} = 150mW$, $20Hz \leq F \leq 20kHz$ $R_L = 16\Omega$, $P_{out} = 220mW$, $20Hz \leq F \leq 20kHz$		0.15 0.2		%
PSRR	Power Supply Rejection Ratio ($A_v=2$) ¹⁾ $F = 1kHz$, $V_{ripple} = 200mV_{pp}$, input grounded, $C_b=1\mu F$	50	56		dB
SNR	Signal-to-Noise Ratio (Filter Type A, $A_v=2$) ¹⁾ ($R_L = 32\Omega$, THD +N < 0.5%, $20Hz \leq F \leq 20kHz$)	85	98		dB
Φ_M	Phase Margin at Unity Gain $R_L = 16\Omega$, $C_L = 400pF$		58		Degrees
GM	Gain Margin $R_L = 16\Omega$, $C_L = 400pF$		18		dB
GBP	Gain Bandwidth Product $R_L = 16\Omega$		1.1		MHz
SR	Slew Rate $R_L = 16\Omega$		0.4		V/ μS

1. Guaranteed by design and evaluation.

ELECTRICAL CHARACTERISTICS

$V_{CC} = +3.3V$, $GND = 0V$, $T_{amb} = 25^{\circ}C$ (unless otherwise specified) ¹⁾

Symbol	Parameter	Min.	Typ.	Max.	Unit
I_{CC}	Supply Current No input signal, no load		1.8	2.5	mA
$I_{STANDBY}$	Standby Current No input signal, $V_{STANDBY}=GND$ for TS421 No input signal, $V_{STANDBY}=V_{CC}$ for TS419		10	1000	nA
V_{OO}	Output Offset Voltage No input signal, $R_L = 16$ or 32Ω , $R_{feed}=20k\Omega$		5	25	mV
P_O	Output Power THD+N = 0.1% Max, $F = 1kHz$, $R_L = 32\Omega$ THD+N = 1% Max, $F = 1kHz$, $R_L = 32\Omega$ THD+N = 10% Max, $F = 1kHz$, $R_L = 32\Omega$ THD+N = 0.1% Max, $F = 1kHz$, $R_L = 16\Omega$ THD+N = 1% Max, $F = 1kHz$, $R_L = 16\Omega$ THD+N = 10% Max, $F = 1kHz$, $R_L = 16\Omega$	65 91	75 81 102 104 113 143		mW
THD + N	Total Harmonic Distortion + Noise ($A_v=2$) $R_L = 32\Omega$, $P_{out} = 50mW$, $20Hz \leq F \leq 20kHz$ $R_L = 16\Omega$, $P_{out} = 70mW$, $20Hz \leq F \leq 20kHz$		0.15 0.2		%
PSRR	Power Supply Rejection Ratio inputs grounded, $F = 1kHz$, $V_{ripple} = 200mV_{pp}$, $C_b=1\mu F$	50	56		dB
SNR	Signal-to-Noise Ratio (Weighted A, $A_v=2$) ($R_L = 32\Omega$, THD +N < 0.5%, $20Hz \leq F \leq 20kHz$)	82	94		dB
Φ_M	Phase Margin at Unity Gain $R_L = 16\Omega$, $C_L = 400pF$		58		Degrees
GM	Gain Margin $R_L = 16\Omega$, $C_L = 400pF$		18		dB
GBP	Gain Bandwidth Product $R_L = 16\Omega$		1.1		MHz
SR	Slew Rate $R_L = 16\Omega$		0.4		V/ μS

1. All electrical values are guaranteed with correlation measurements at 2V and 5V

ELECTRICAL CHARACTERISTICS

$V_{CC} = +2.5V$, $GND = 0V$, $T_{amb} = 25^{\circ}C$ (unless otherwise specified)¹⁾

Symbol	Parameter	Min.	Typ.	Max.	Unit
I_{CC}	Supply Current No input signal, no load		1.7	2.5	mA
$I_{STANDBY}$	Standby Current No input signal, $V_{STANDBY}=GND$ for TS421 No input signal, $V_{STANDBY}=V_{CC}$ for TS419		10	1000	nA
V_{OO}	Output Offset Voltage No input signal, $R_L = 16$ or 32Ω , $R_{feed}=20k\Omega$		5	25	mV
P_O	Output Power THD+N = 0.1% Max, $F = 1kHz$, $R_L = 32\Omega$ THD+N = 1% Max, $F = 1kHz$, $R_L = 32\Omega$ THD+N = 10% Max, $F = 1kHz$, $R_L = 32\Omega$ THD+N = 0.1% Max, $F = 1kHz$, $R_L = 16\Omega$ THD+N = 1% Max, $F = 1kHz$, $R_L = 16\Omega$ THD+N = 10% Max, $F = 1kHz$, $R_L = 16\Omega$	32 44	37 41 52 50 55 70		mW
THD + N	Total Harmonic Distortion + Noise ($A_v=2$) $R_L = 32\Omega$, $P_{out} = 30mW$, $20Hz \leq F \leq 20kHz$ $R_L = 16\Omega$, $P_{out} = 40mW$, $20Hz \leq F \leq 20kHz$		0.15 0.2		%
PSRR	Power Supply Rejection Ratio ($A_v=2$) inputs grounded, $F = 1kHz$, $V_{ripple} = 200mV_{pp}$, $C_b=1\mu F$	50	56		dB
SNR	Signal-to-Noise Ratio (Weighted A, $A_v=2$) ($R_L = 32\Omega$, THD +N < 0.5%, $20Hz \leq F \leq 20kHz$)	80	91		dB
Φ_M	Phase Margin at Unity Gain $R_L = 16\Omega$, $C_L = 400pF$		58		Degrees
GM	Gain Margin $R_L = 16\Omega$, $C_L = 400pF$		18		dB
GBP	Gain Bandwidth Product $R_L = 16\Omega$		1.1		MHz
SR	Slew Rate $R_L = 16\Omega$		0.4		V/ μS

1. All electrical values are guaranteed with correlation measurements at 2V and 5V

ELECTRICAL CHARACTERISTICS

$V_{CC} = +2V$, $GND = 0V$, $T_{amb} = 25^{\circ}C$ (unless otherwise specified)

Symbol	Parameter	Min.	Typ.	Max.	Unit
I_{CC}	Supply Current No input signal, no load		1.7	2.5	mA
$I_{STANDBY}$	Standby Current No input signal, $V_{STANDBY}=GND$ for TS421 No input signal, $V_{STANDBY}=V_{CC}$ for TS419		10	1000	nA
V_{OO}	Output Offset Voltage No input signal, $R_L = 16$ or 32Ω , $R_{feed}=20k\Omega$		5	25	mV
P_O	Output Power THD+N = 0.1% Max, $F = 1kHz$, $R_L = 32\Omega$ THD+N = 1% Max, $F = 1kHz$, $R_L = 32\Omega$ THD+N = 10% Max, $F = 1kHz$, $R_L = 32\Omega$ THD+N = 0.1% Max, $F = 1kHz$, $R_L = 16\Omega$ THD+N = 1% Max, $F = 1kHz$, $R_L = 16\Omega$ THD+N = 10% Max, $F = 1kHz$, $R_L = 16\Omega$	19 24	20 23 30 26 30 40		mW
THD + N	Total Harmonic Distortion + Noise ($A_v=2$) $R_L = 32\Omega$, $P_{out} = 13mW$, $20Hz \leq F \leq 20kHz$ $R_L = 16\Omega$, $P_{out} = 20mW$, $20Hz \leq F \leq 20kHz$		0.1 0.15		%
PSRR	Power Supply Rejection Ratio ($A_v=2$) ¹⁾ inputs grounded, $F = 1kHz$, $V_{ripple} = 200mV_{pp}$, $C_b=1\mu F$	49	54		dB
SNR	Signal-to-Noise Ratio (Weighted A, $A_v=2$) ¹⁾ ($R_L = 32\Omega$, THD +N < 0.5%, $20Hz \leq F \leq 20kHz$)	80	89		dB
Φ_M	Phase Margin at Unity Gain $R_L = 16\Omega$, $C_L = 400pF$		58		Degrees
GM	Gain Margin $R_L = 16\Omega$, $C_L = 400pF$		20		dB
GBP	Gain Bandwidth Product $R_L = 16\Omega$		1.1		MHz
SR	Slew Rate $R_L = 16\Omega$		0.4		V/ μS

1. Guaranteed by design and evaluation.

Index of Graphs

Description	Figure	Page
Common Curves		
Open Loop Gain and Phase vs Frequency	1 to 12	9 to 10
Current Consumption vs Power Supply Voltage	13	11
Current Consumption vs Standby Voltage	14 to 19	11 to 12
Output Power vs Power Supply Voltage	20 to 23	12
Output Power vs Load Resistor	24 to 27	12 to 13
Power Dissipation vs Output Power	28 to 31	13 to 14
Power Derating vs Ambient Temperature	32	14
Output Voltage Swing vs Supply Voltage	33	14
Low Frequency Cut Off vs Input Capacitor	34	14
Curves With 6dB Gain Setting (Av=2)		
THD + N vs Output Power	35 to 43	15 to 16
THD + N vs Frequency	44 to 46	16
Signal to Noise Ratio vs Power Supply Voltage	47 to 48	17
Noise Floor	49 to 50	17
PSRR vs Frequency	51 to 55	17 to 18
Curves With 12dB Gain Setting (Av=4)		
THD + N vs Output Power	56 to 64	19 to 20
THD + N vs Frequency	65 to 67	20
Signal to Noise Ratio vs Power Supply Voltage	68 to 69	21
Noise Floor	70 to 71	21
PSRR vs Frequency	72 to 76	21 to 22
Curves With 18dB Gain Setting (Av=8)		
THD + N vs Output Power	77 to 85	23 to 24
THD + N vs Frequency	86 to 88	24
Signal to Noise Ratio vs Power Supply Voltage	89 to 90	25
Noise Floor	91 to 92	25
PSRR vs Frequency	93 to 97	25 to 26

Note : All measurements made with Rin=20kΩ, Cb=1μF, and Cin=10μF unless otherwise specified.

Fig. 1: Open Loop Gain and Phase vs Frequency

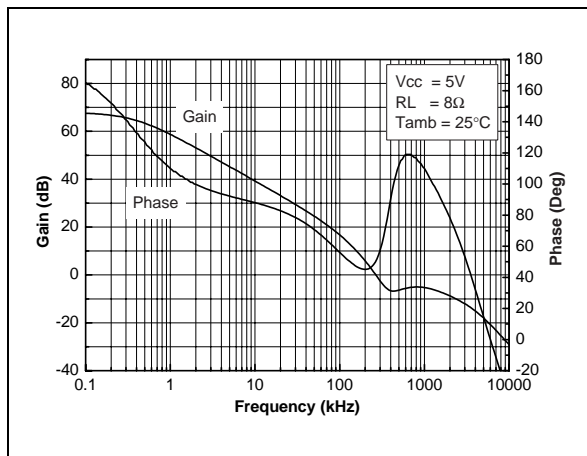

Fig. 2: Open Loop Gain and Phase vs Frequency

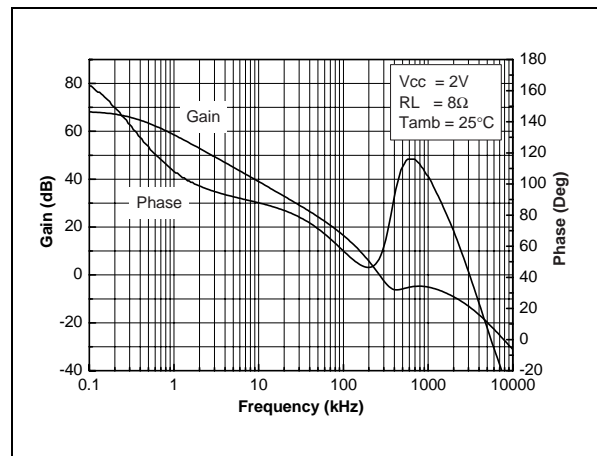

Fig. 3: Open Loop Gain and Phase vs Frequency

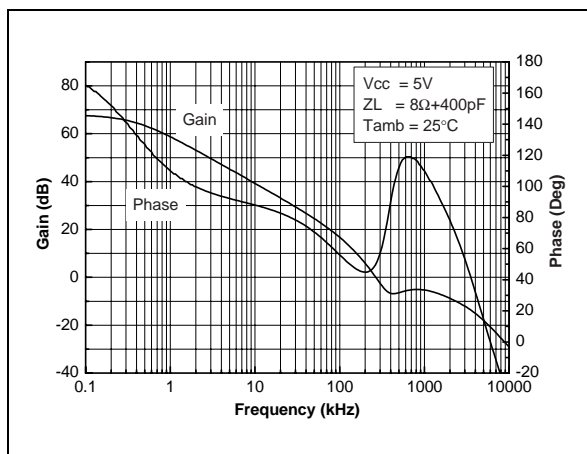

Fig. 4: Open Loop Gain and Phase vs Frequency

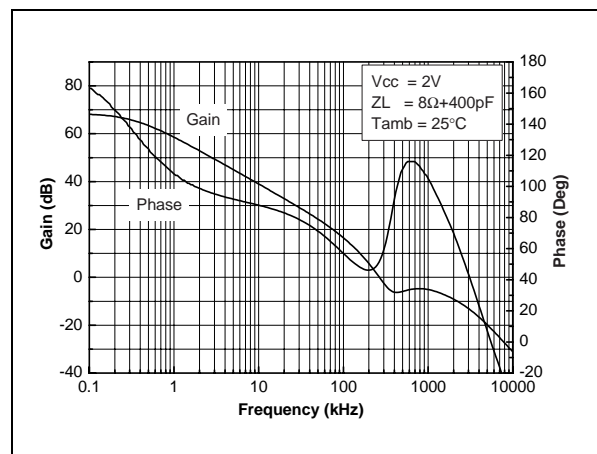

Fig. 5: Open Loop Gain and Phase vs Frequency

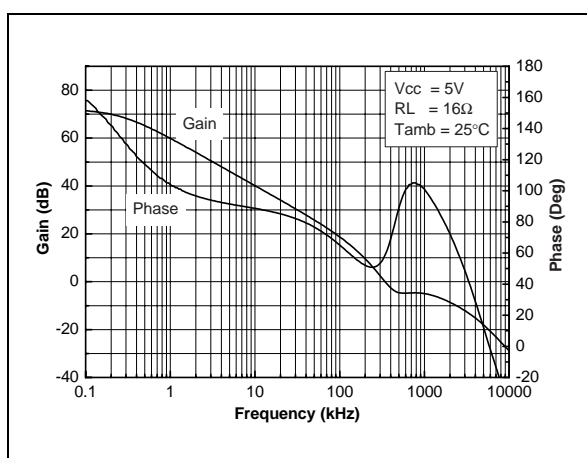

Fig. 6: Open Loop Gain and Phase vs Frequency

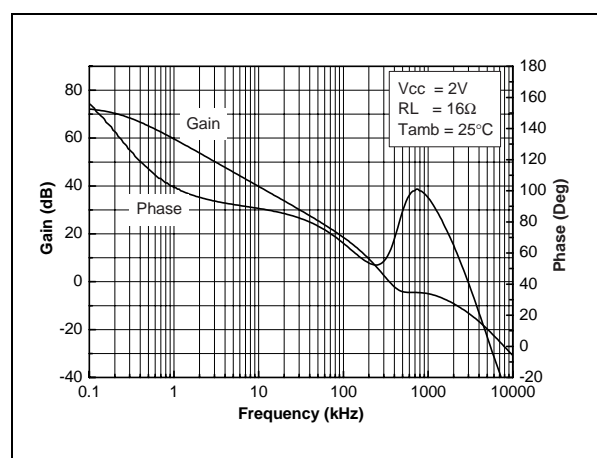

Fig. 7: Open Loop Gain and Phase vs Frequency

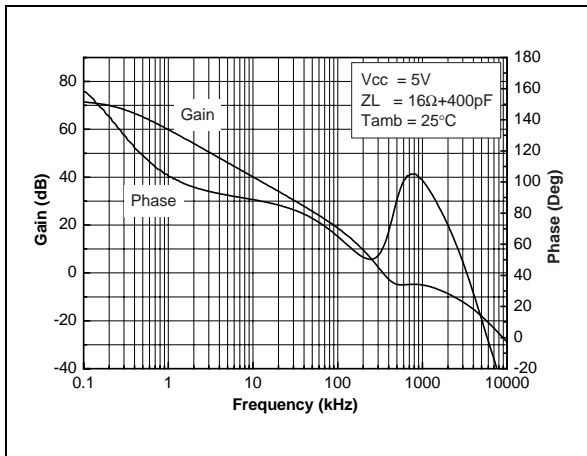

Fig. 8: Open Loop Gain and Phase vs Frequency

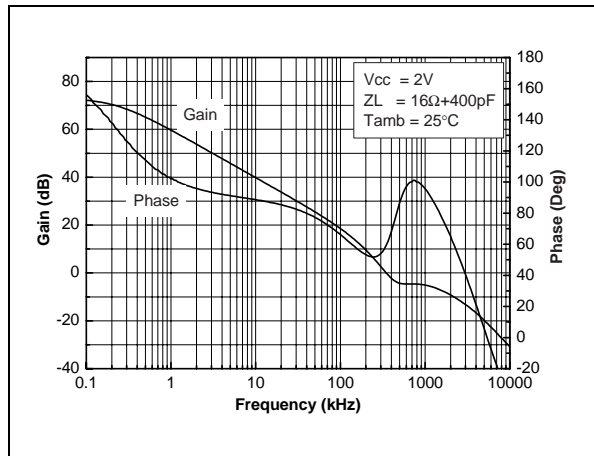

Fig. 9: Open Loop Gain and Phase vs Frequency

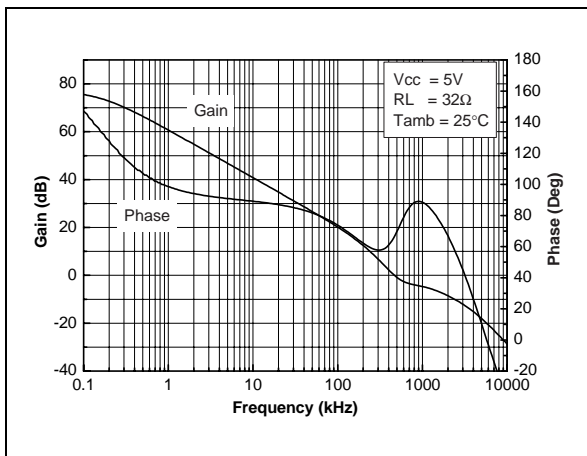

Fig. 10: Open Loop Gain and Phase vs Frequency

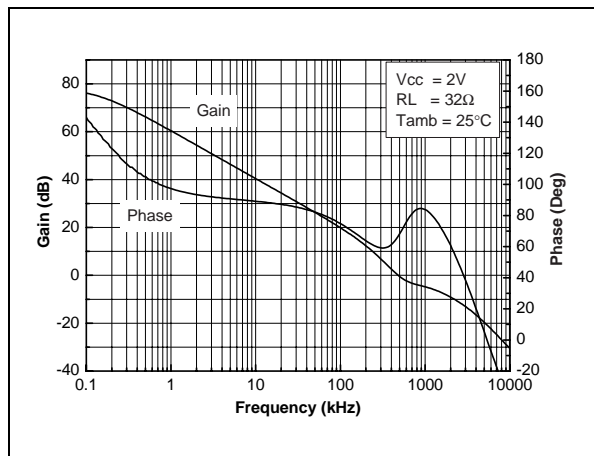

Fig. 11: Open Loop Gain and Phase vs Frequency

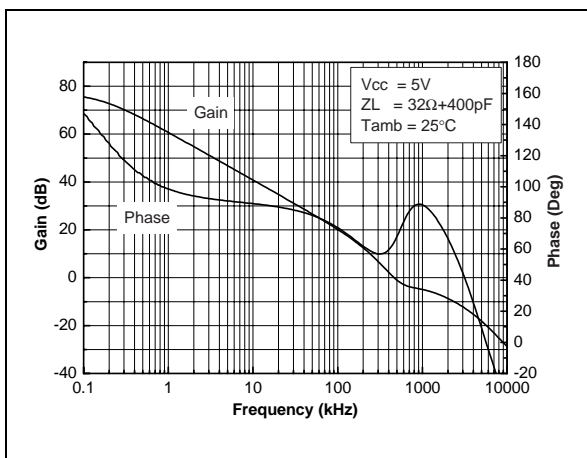

Fig. 12: Open Loop Gain and Phase vs Frequency

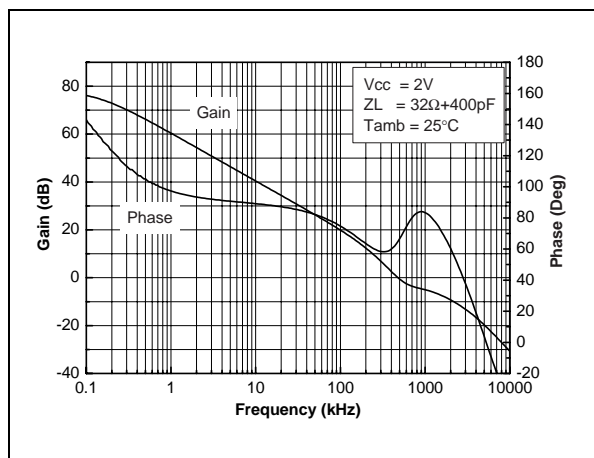

Fig. 13: Current Consumption vs Power Supply Voltage

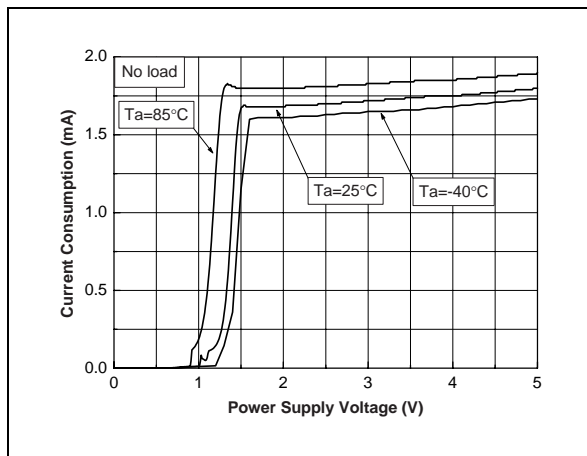

Fig. 14: Current Consumption vs Standby Voltage

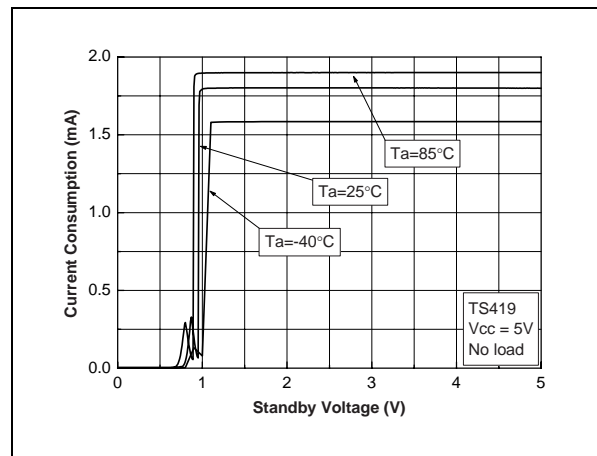

Fig. 15: Current Consumption vs Standby Voltage

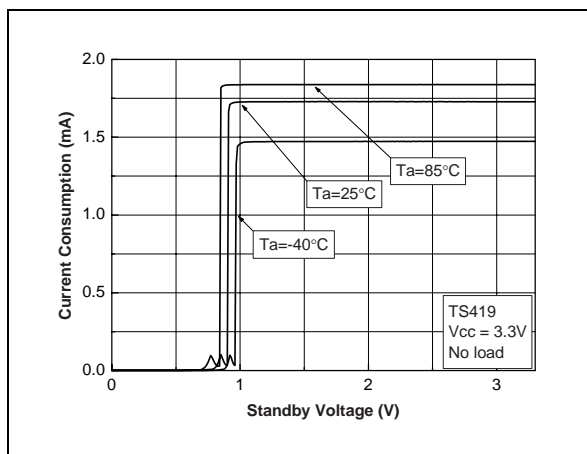

Fig. 16: Current Consumption vs Standby Voltage

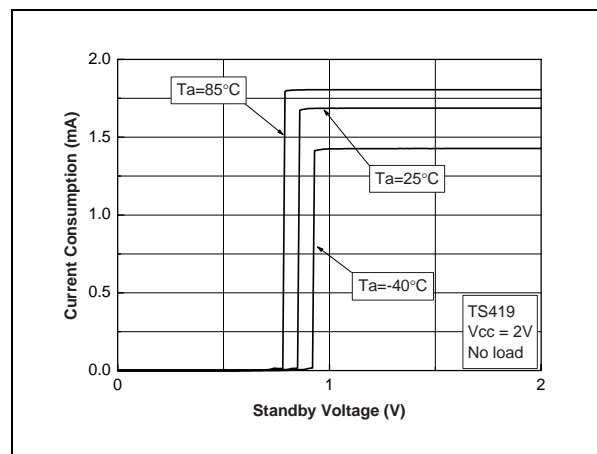

Fig. 17: Current Consumption vs Standby Voltage

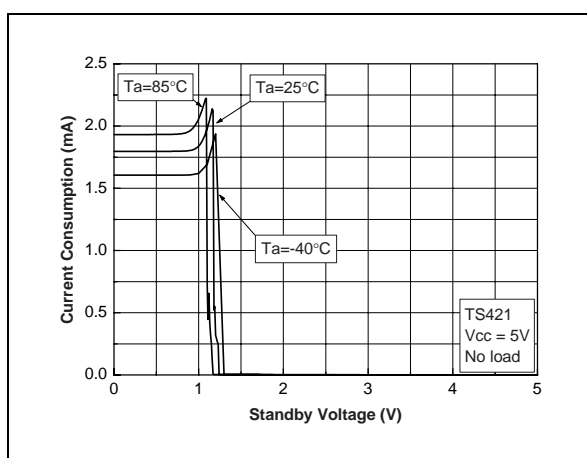

Fig. 18: Current Consumption vs Standby Voltage

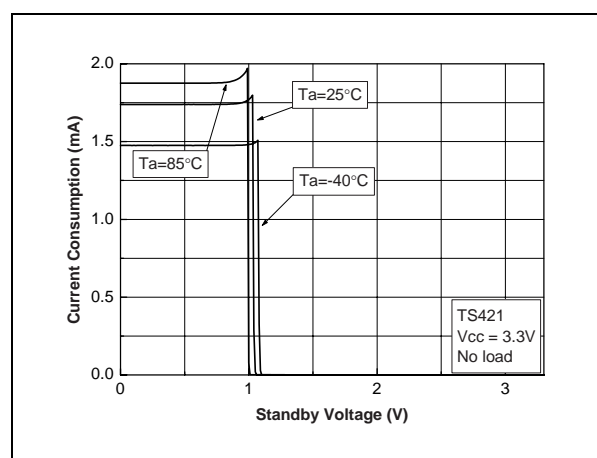

Fig. 19: Current Consumption vs Standby Voltage

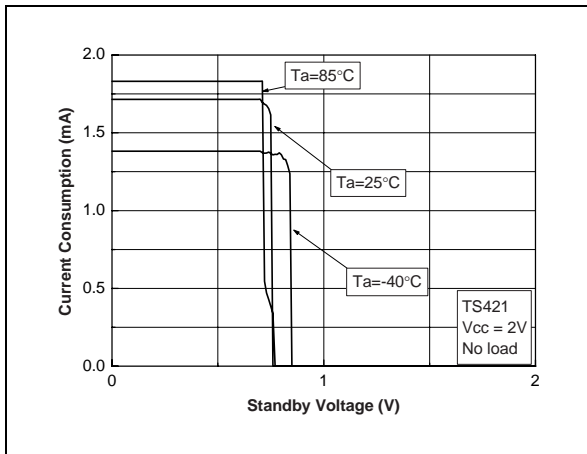

Fig. 21: Output Power vs Power Supply Voltage

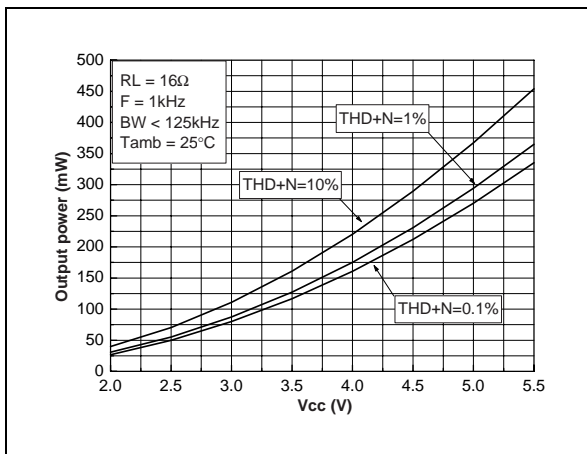

Fig. 23: Output Power vs Power Supply Voltage

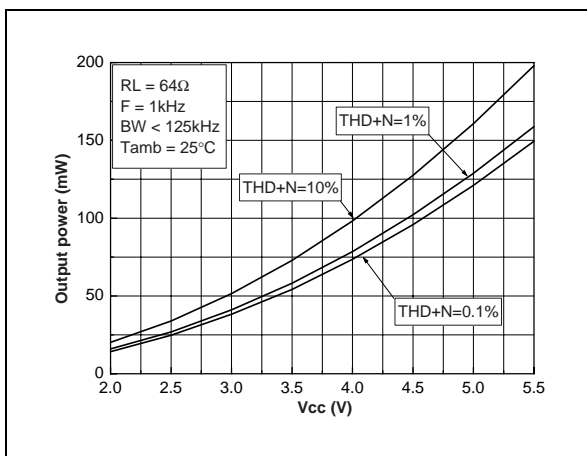

Fig. 20: Output Power vs Power Supply Voltage

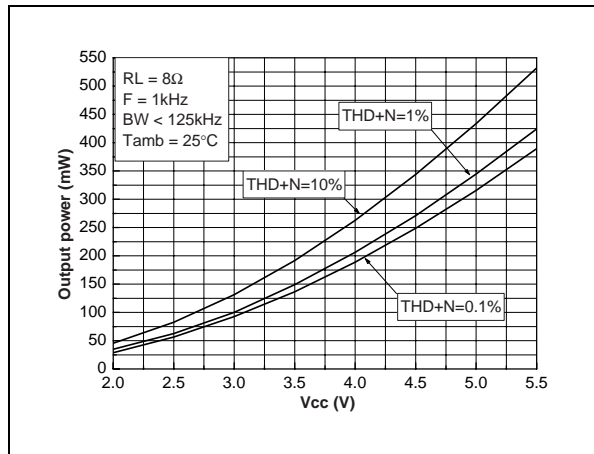

Fig. 22: Output Power vs Power Supply Voltage

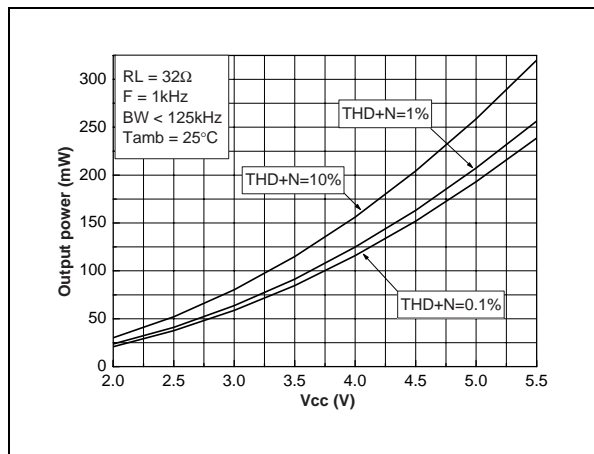

Fig. 24: Output Power vs Load Resistor

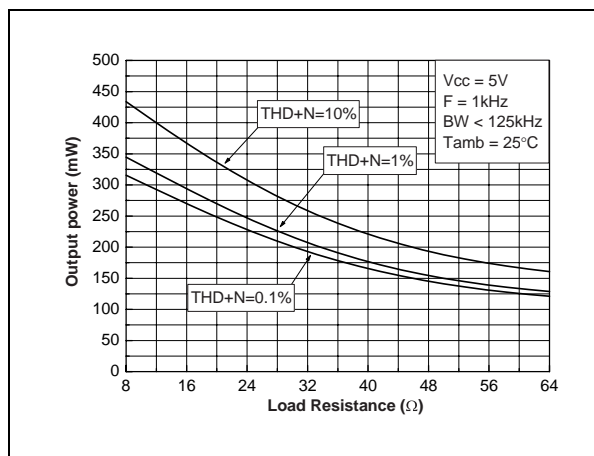

Fig. 25: Output Power vs Load Resistor

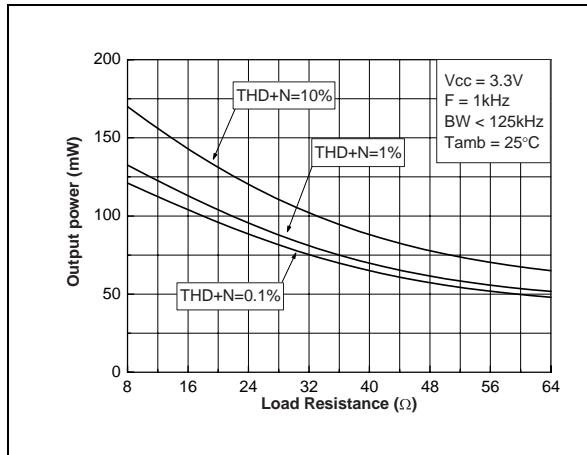

Fig. 26: Output Power vs Load Resistor

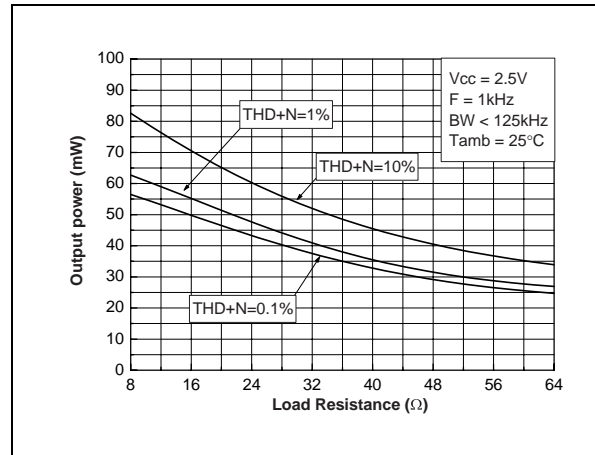

Fig. 27: Output Power vs Load Resistor

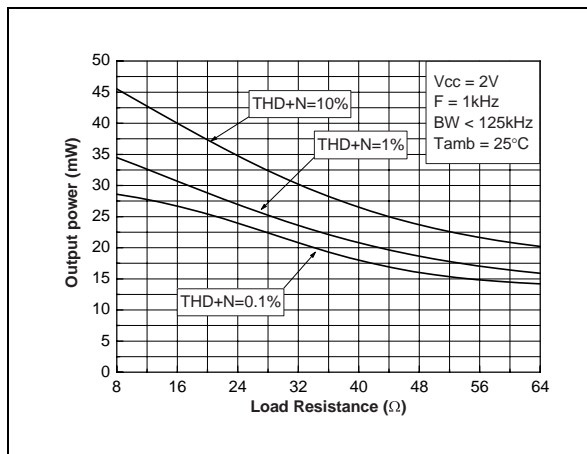

Fig. 28: Power Dissipation vs Output Power

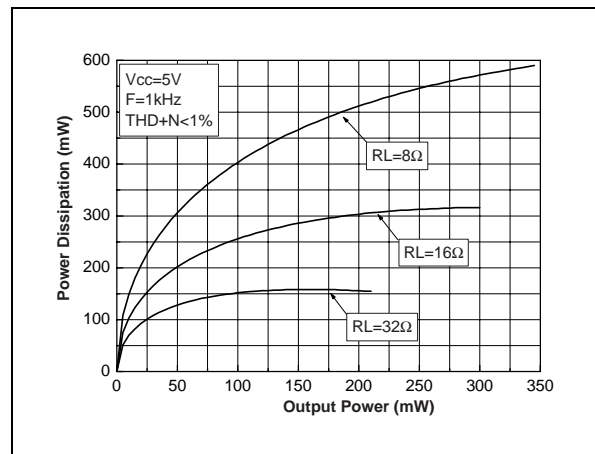

Fig. 29: Power Dissipation vs Output Power

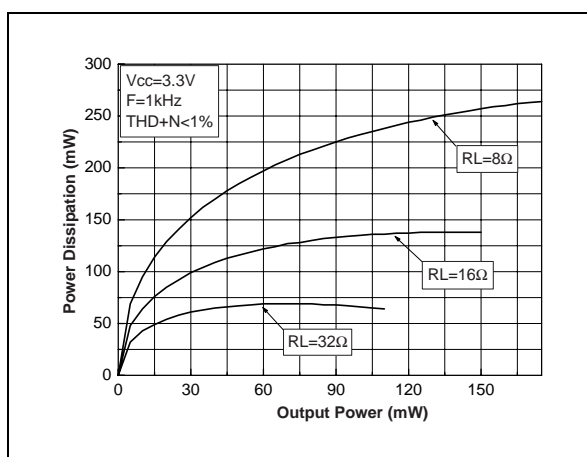

Fig. 30: Power Dissipation vs Output Power

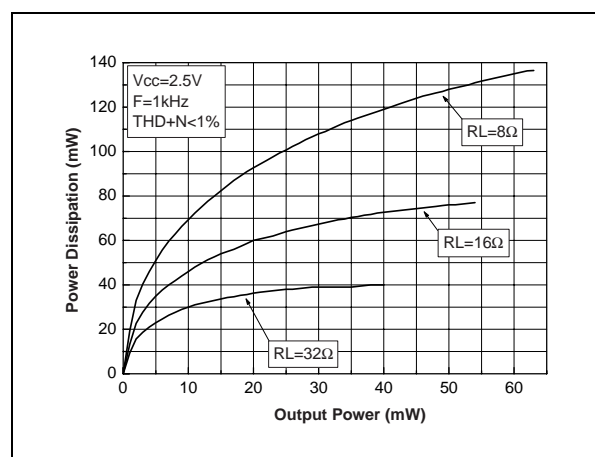

Fig. 31: Power Dissipation vs Output Power

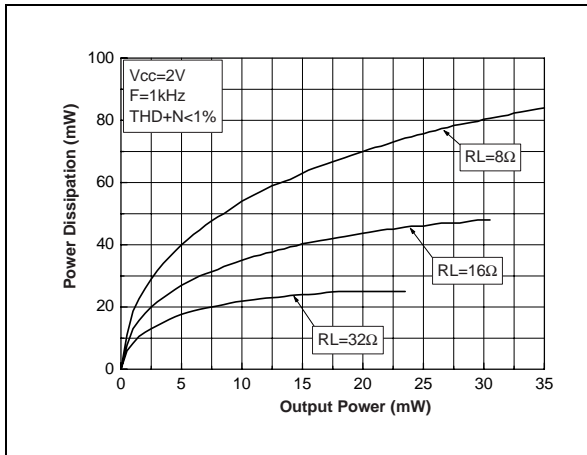

Fig. 32: Power Derating Curves

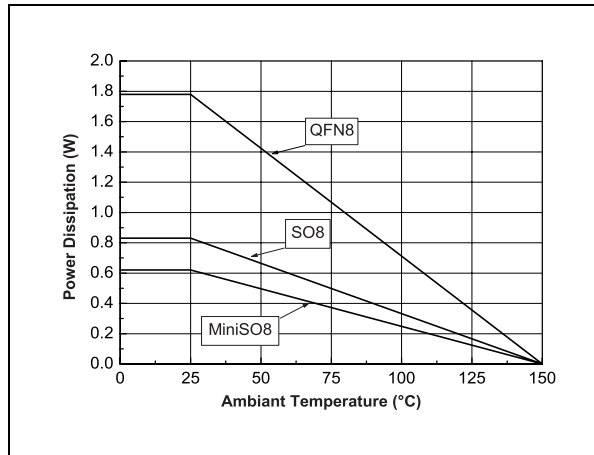

Fig. 33: Output Voltage Swing For One Amp. vs Power Supply Voltage

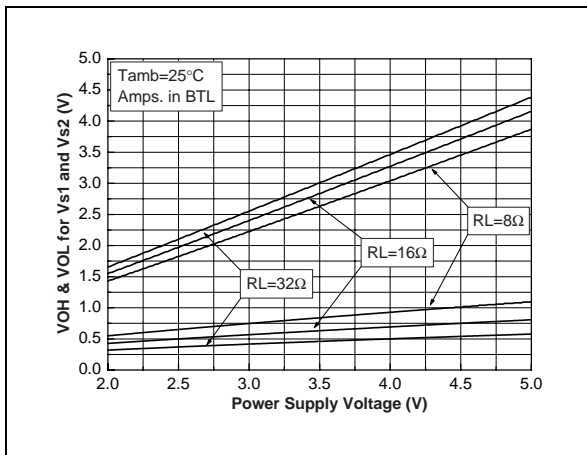

Fig. 34: Low Frequency Cut Off vs Input Capacitor for fixed gain versions

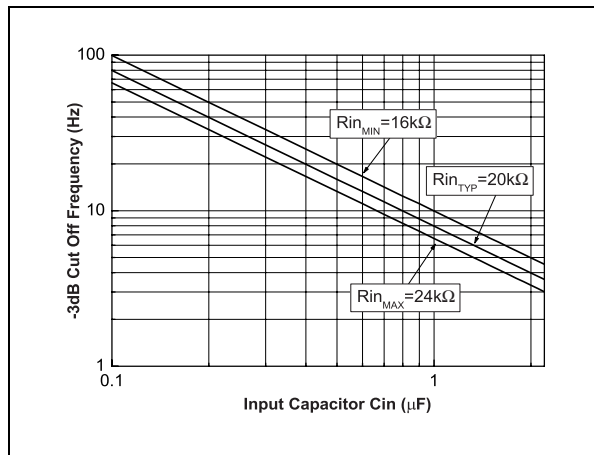

Fig. 35: THD + N vs Output Power

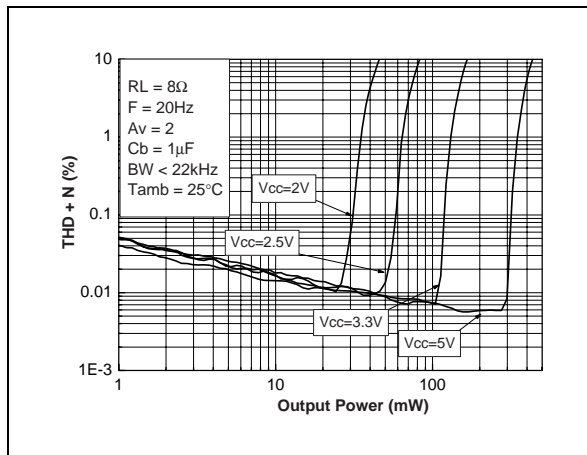

Fig. 36: THD + N vs Output Power

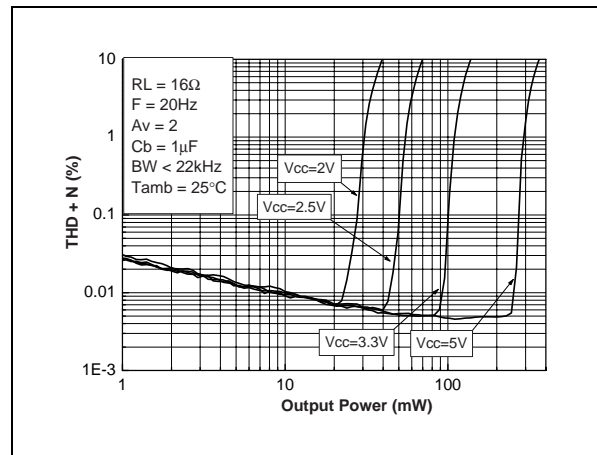

Fig. 37: THD + N vs Output Power

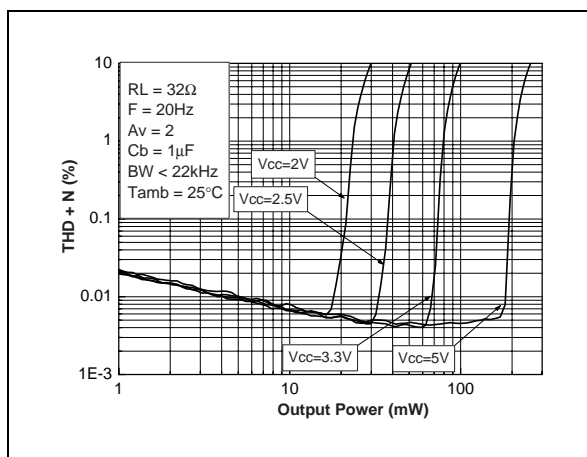

Fig. 38: THD + N vs Output Power

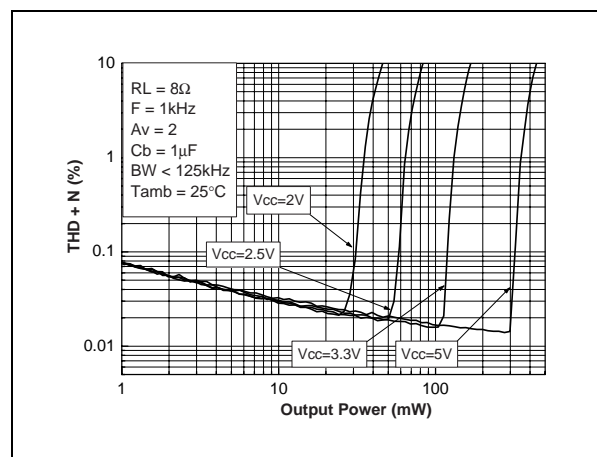

Fig. 39: THD + N vs Output Power

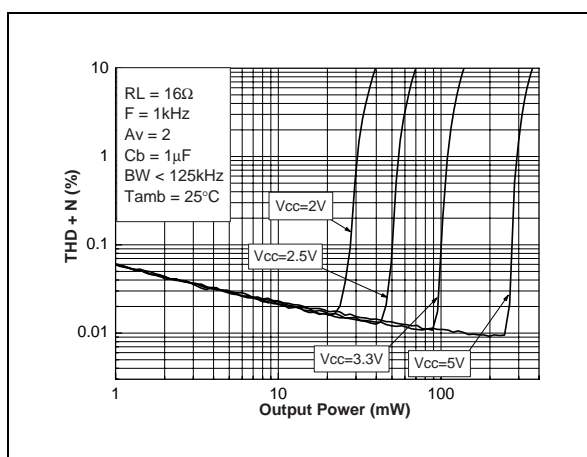

Fig. 40: THD + N vs Output Power

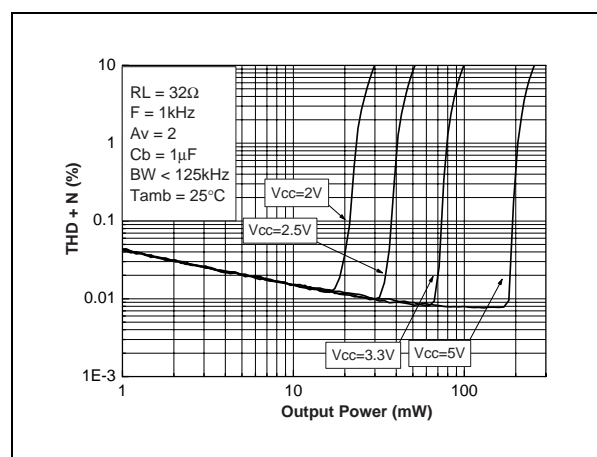

Fig. 41: THD + N vs Output Power

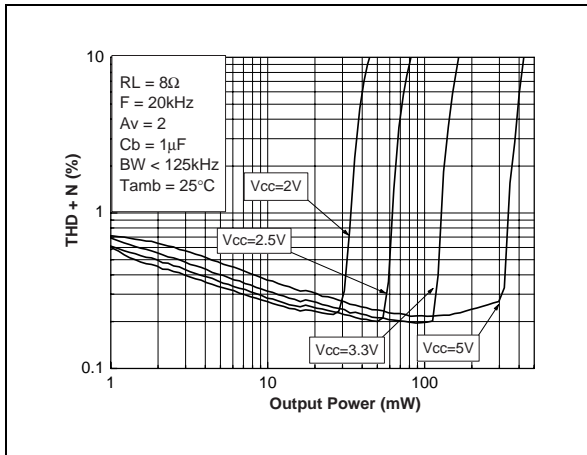

Fig. 42: THD + N vs Output Power

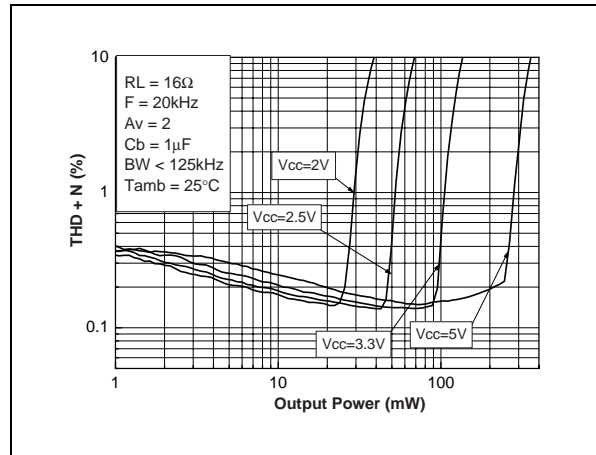

Fig. 43: THD + N vs Output Power

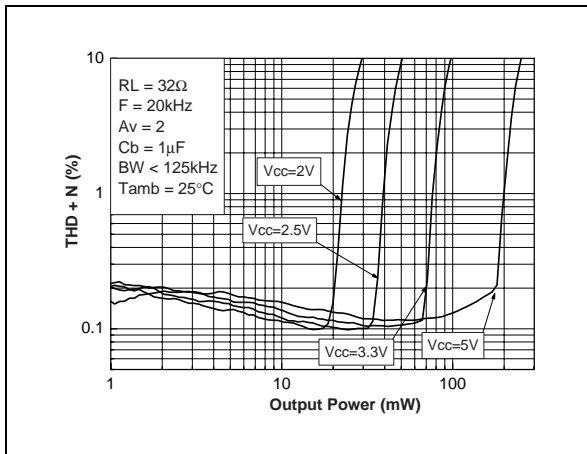

Fig. 44: THD + N vs Frequency

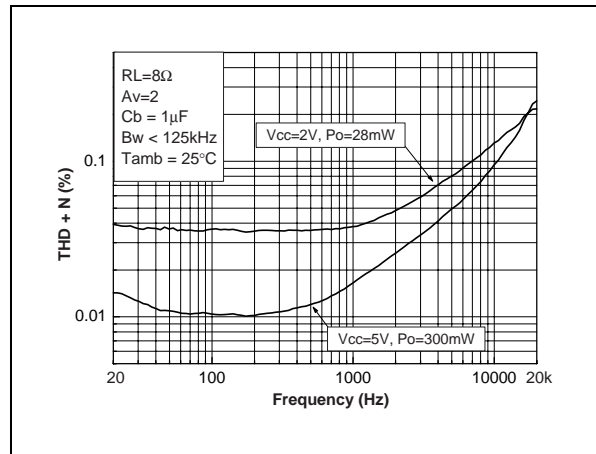

Fig. 45: THD + N vs Frequency

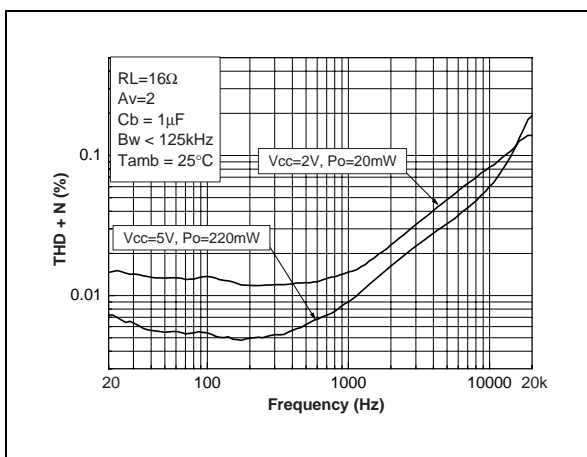

Fig. 46: THD + N vs Frequency

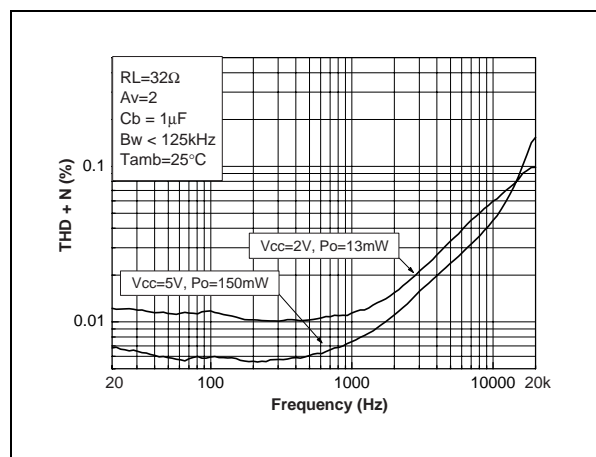

Fig. 47: Signal to Noise Ratio vs Power Supply Voltage with Unweighted Filter (20Hz to 20kHz)

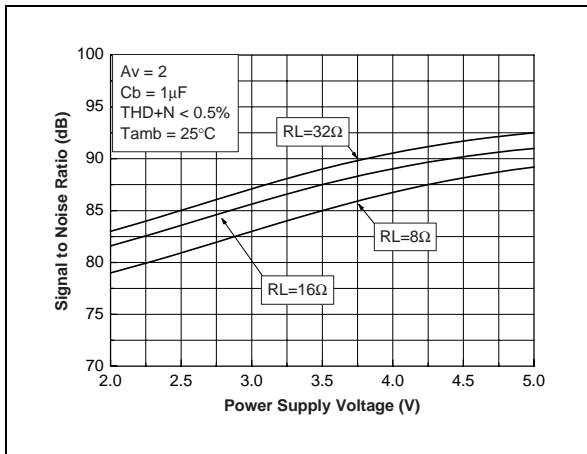

Fig. 48: Signal to Noise Ratio vs Power Supply Voltage with Weighted Filter Type A

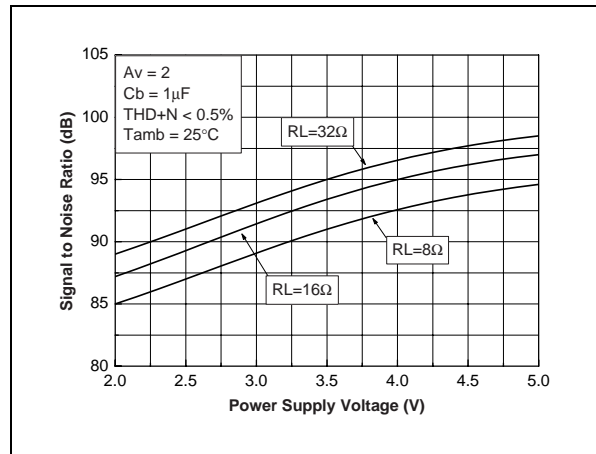

Fig. 49: Noise Floor

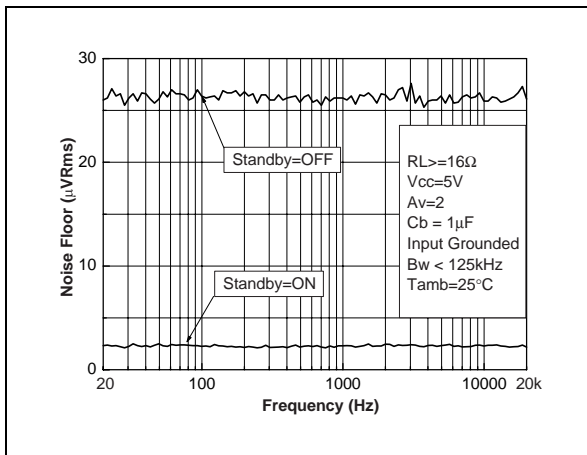

Fig. 50: Noise Floor

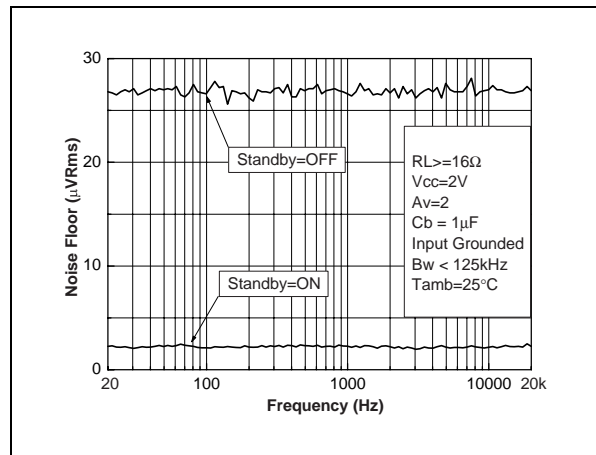

Fig. 51: PSRR vs Input Capacitor

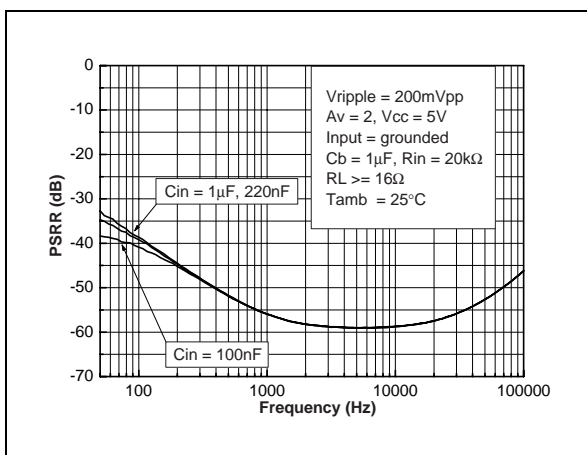

Fig. 52: PSRR vs Power Supply Voltage

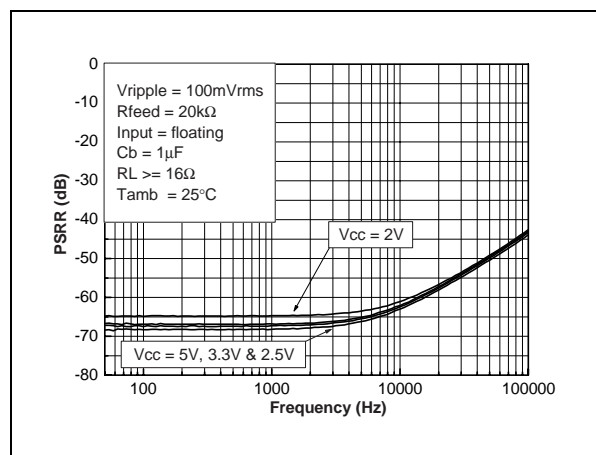

Fig. 53: PSRR vs Bypass Capacitor

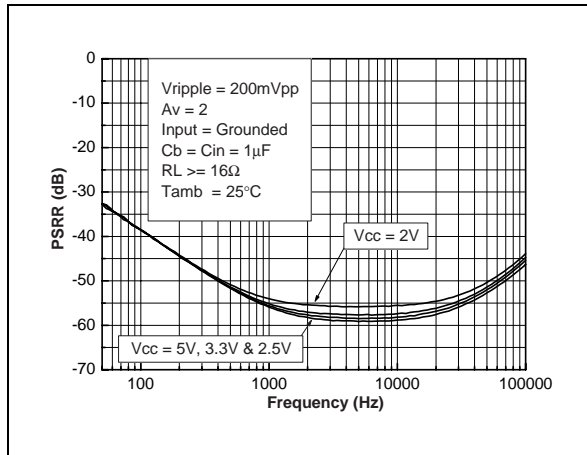

Fig. 54: PSRR vs Bypass Capacitor

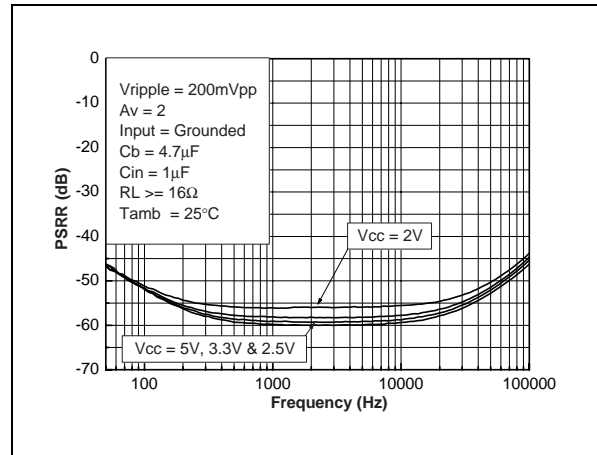

Fig. 55: PSRR vs Bypass Capacitor

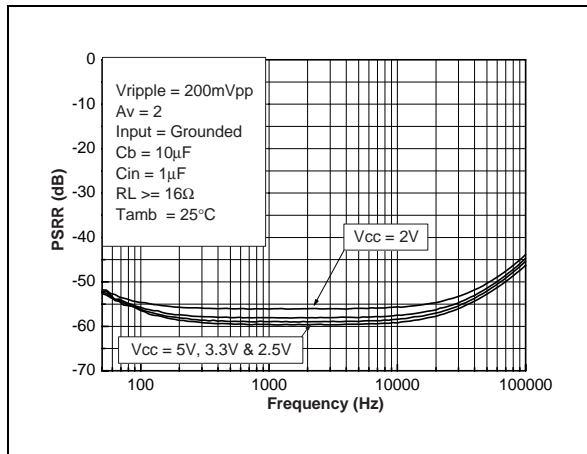

Fig. 56: THD + N vs Output Power

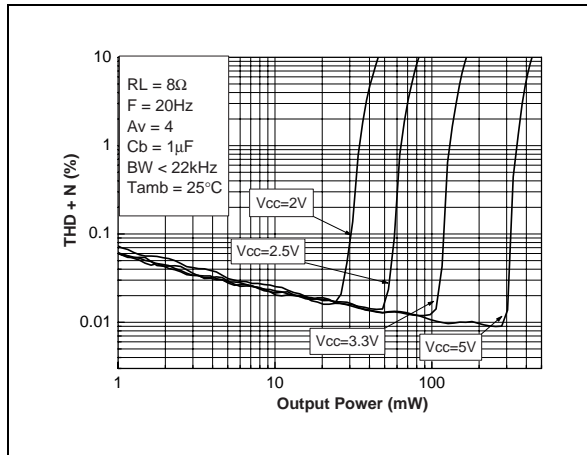

Fig. 57: THD + N vs Output Power

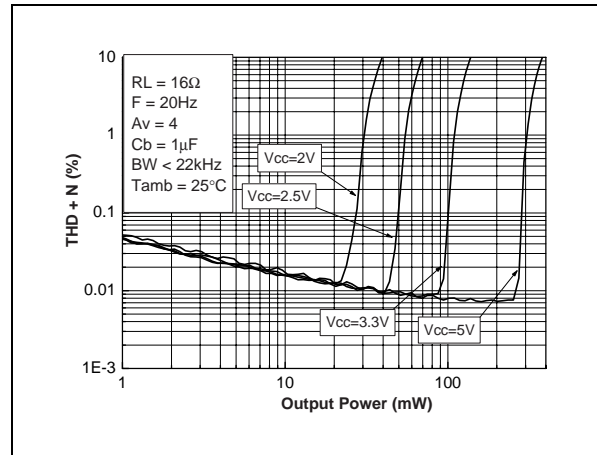

Fig. 58: THD + N vs Output Power

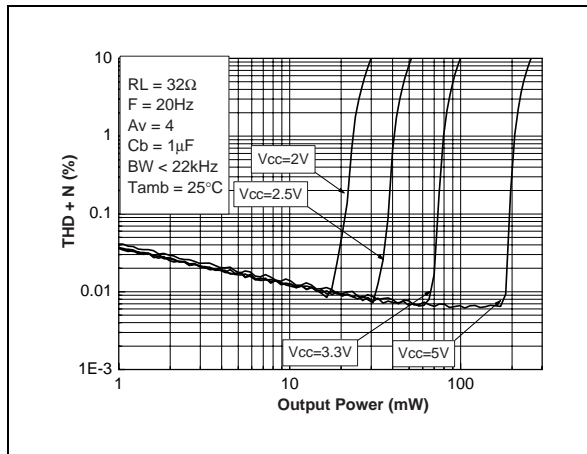

Fig. 59: THD + N vs Output Power

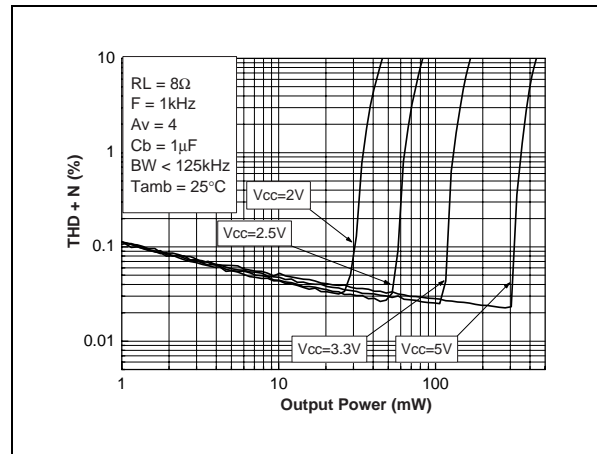

Fig. 60: THD + N vs Output Power

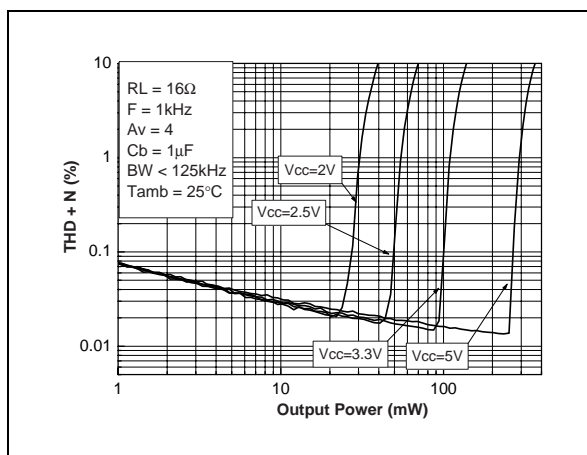

Fig. 61: THD + N vs Output Power

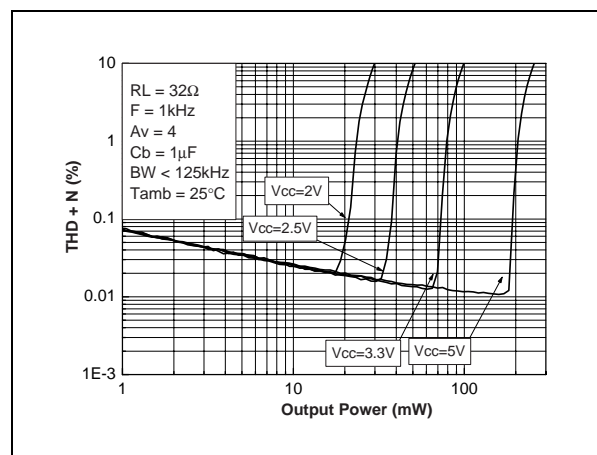

Fig. 62: THD + N vs Output Power

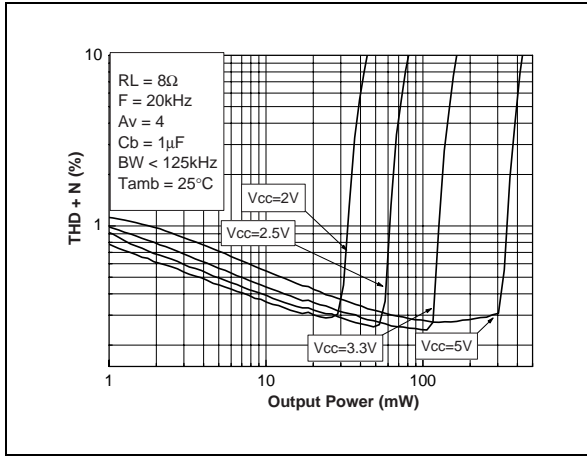

Fig. 63: THD + N vs Output Power

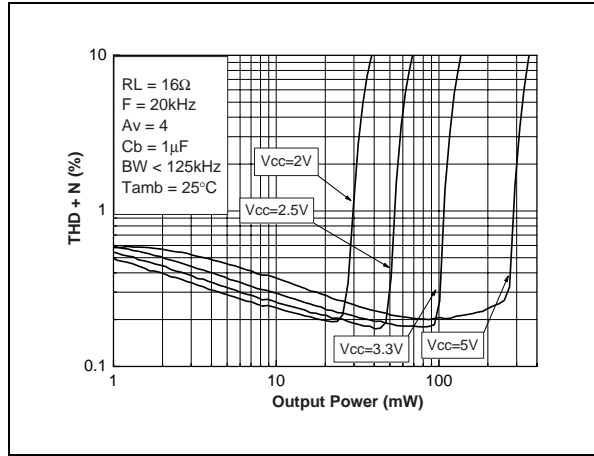

Fig. 64: THD + N vs Output Power

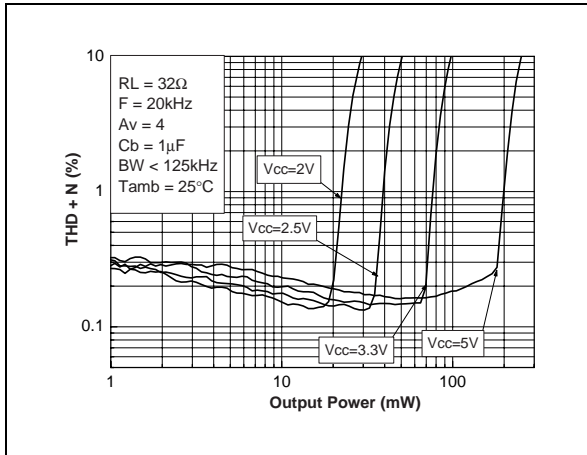

Fig. 65: THD + N vs Frequency

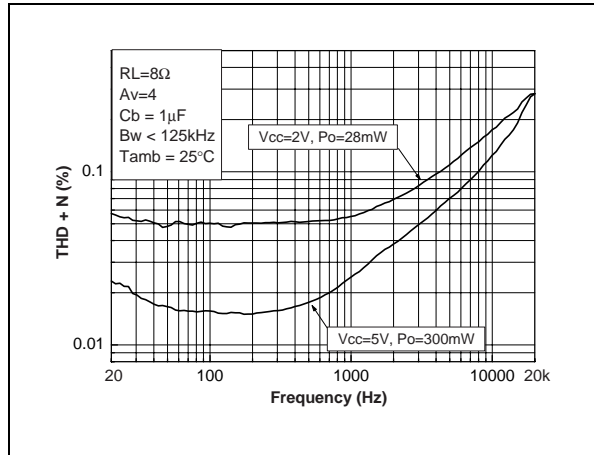

Fig. 66: THD + N vs Frequency

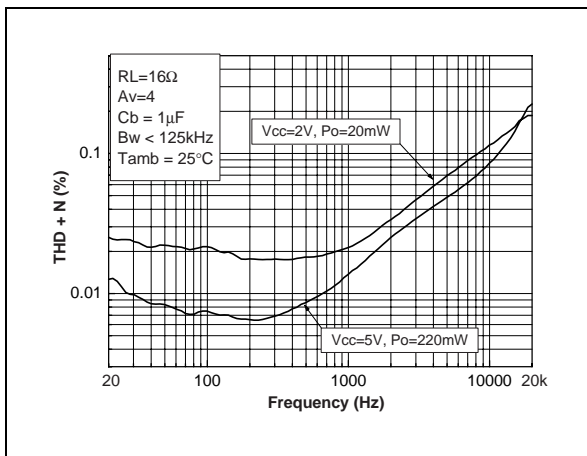

Fig. 67: THD + N vs Frequency

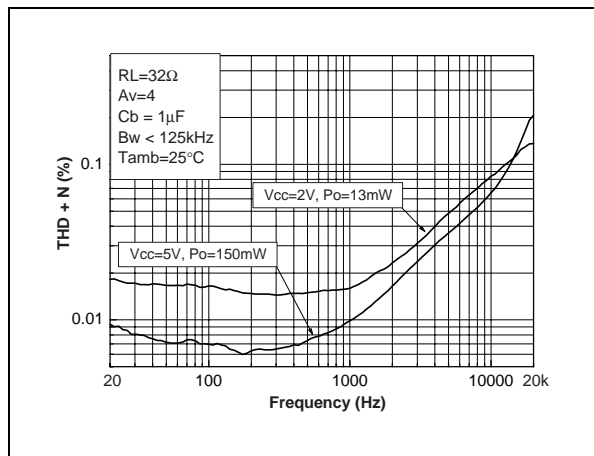

Fig. 68: Signal to Noise Ratio vs Power Supply Voltage with Unweighted Filter (20Hz to 20kHz)

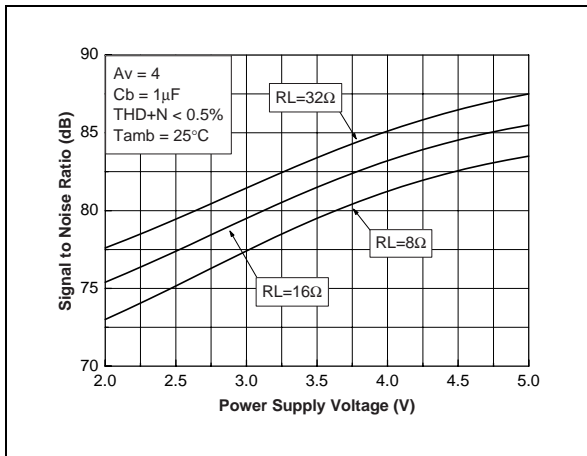

Fig. 69: Signal to Noise Ratio vs Power Supply Voltage with Weighted Filter Type A

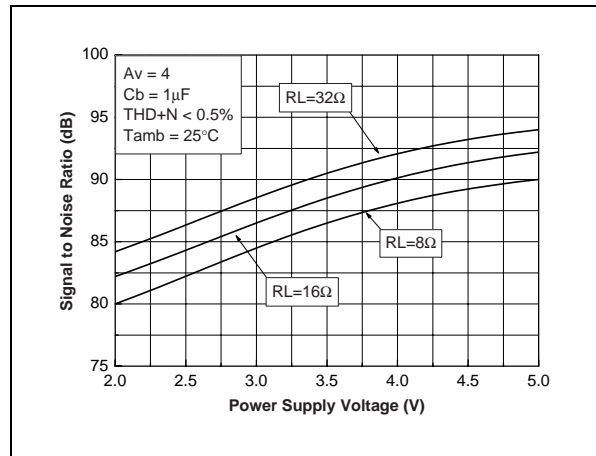

Fig. 70: Noise Floor

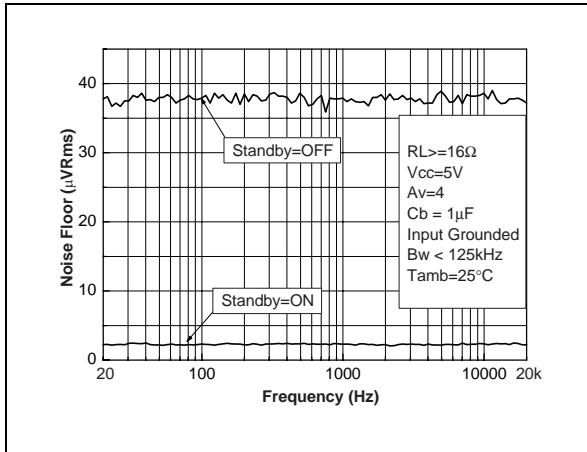

Fig. 71: Noise Floor

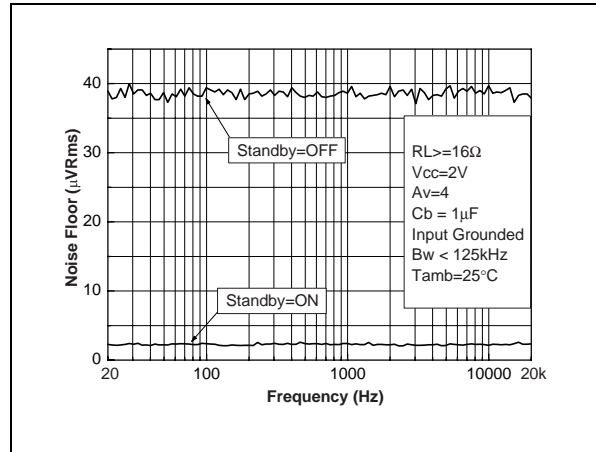

Fig. 72: PSRR vs Power Supply Voltage

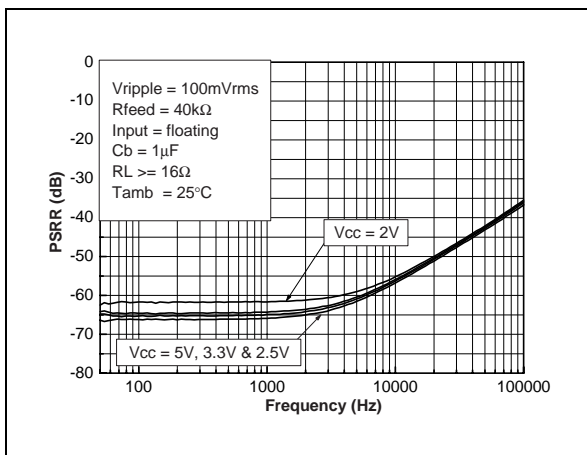

Fig. 73: PSRR vs Input Capacitor

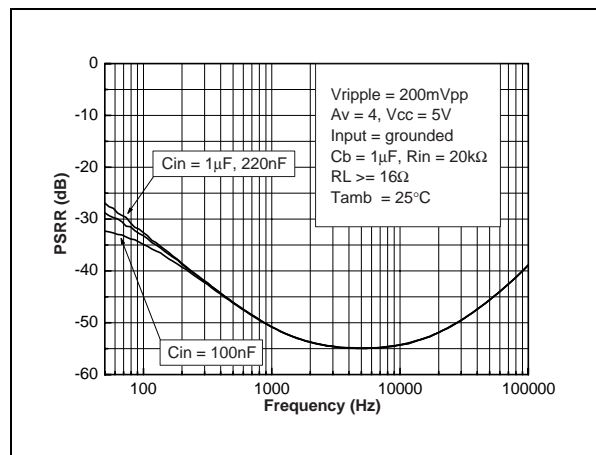

Fig. 74: PSRR vs Bypass Capacitor

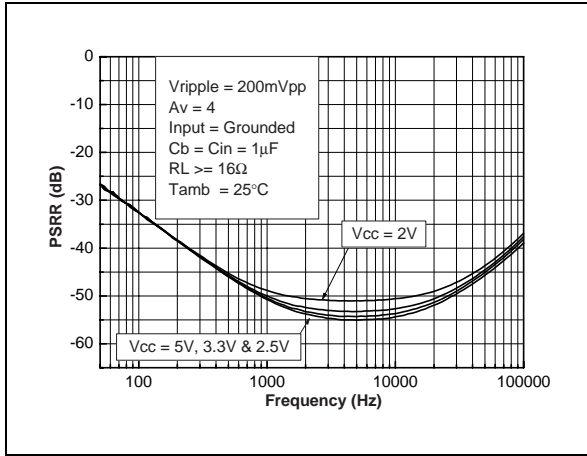

Fig. 75: PSRR vs Bypass Capacitor

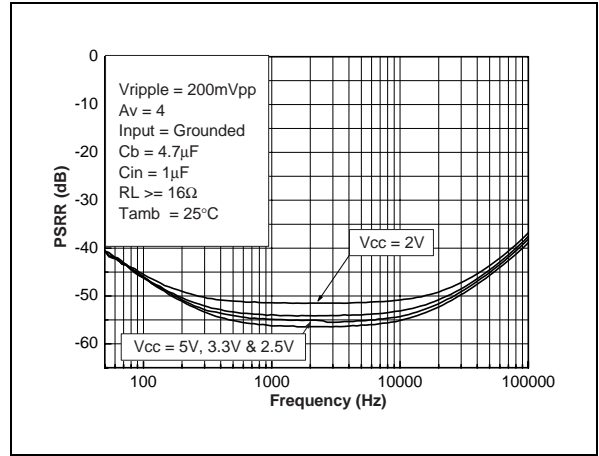

Fig. 76: PSRR vs Bypass Capacitor

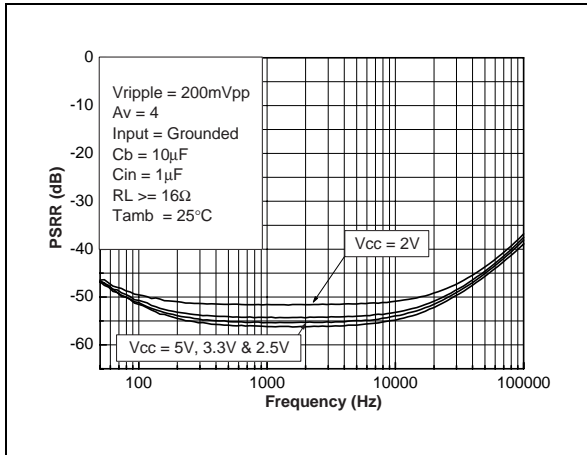

Fig. 77: THD + N vs Output Power

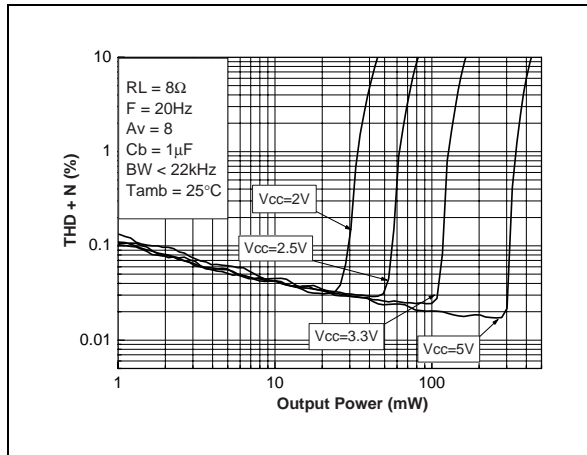

Fig. 78: THD + N vs Output Power

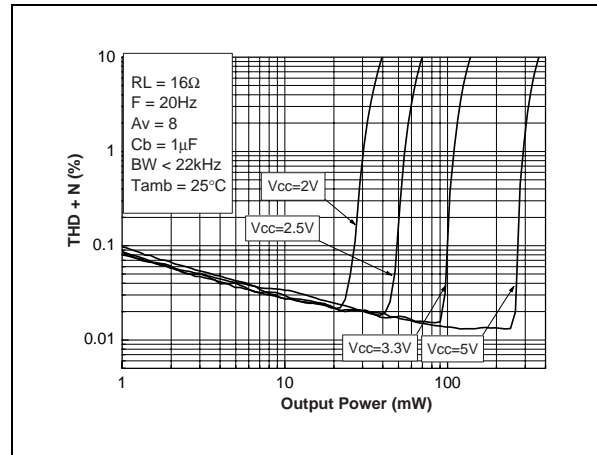

Fig. 79: THD + N vs Output Power

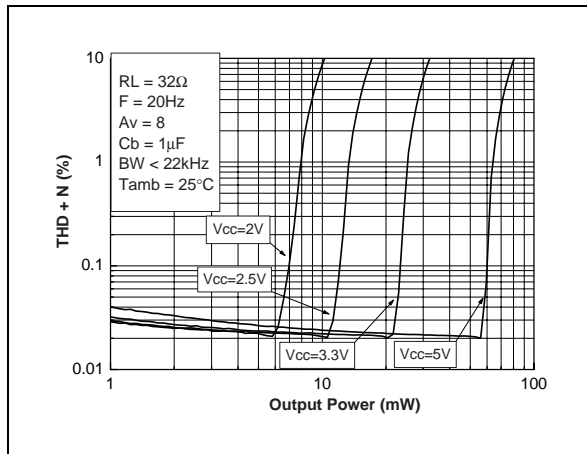

Fig. 80: THD + N vs Output Power

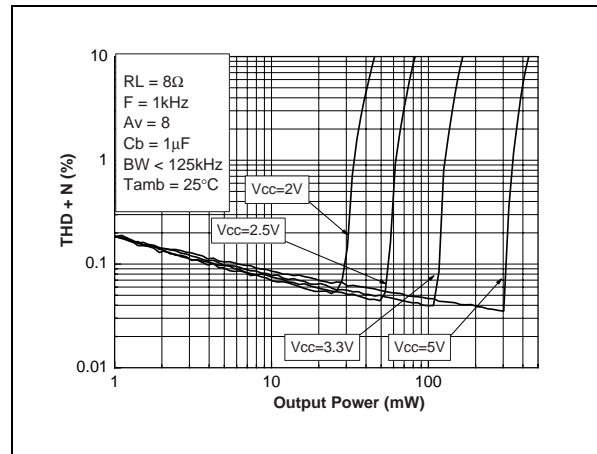

Fig. 81: THD + N vs Output Power

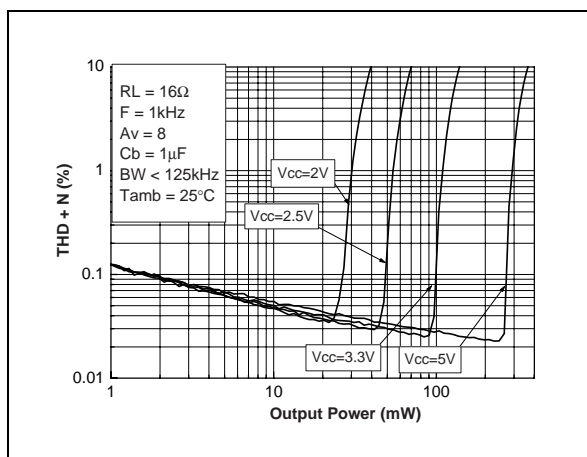

Fig. 82: THD + N vs Output Power

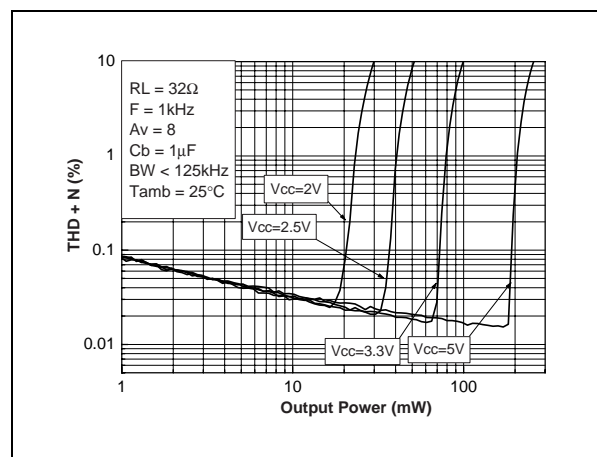

Fig. 83: THD + N vs Output Power

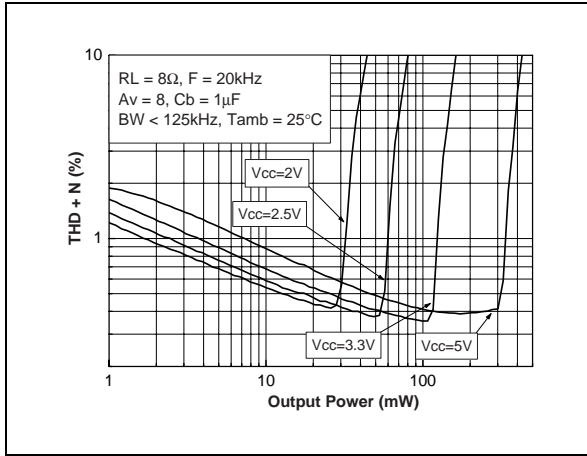

Fig. 84: THD + N vs Output Power

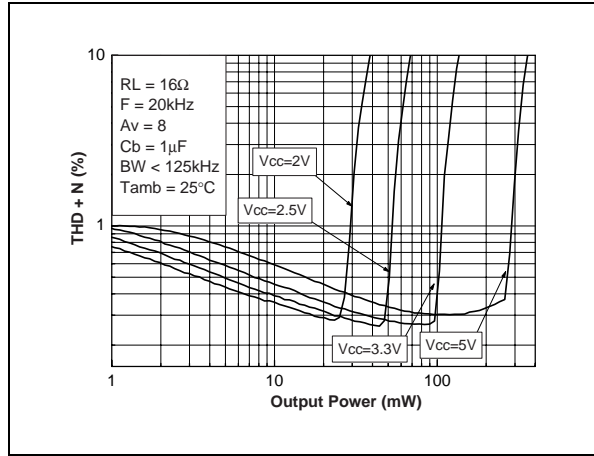

Fig. 85: THD + N vs Output Power

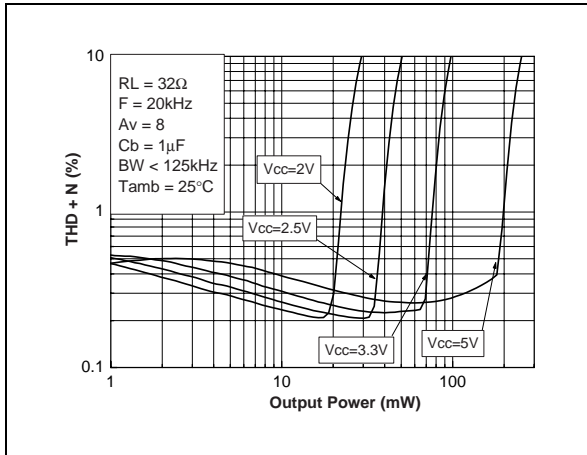

Fig. 86: THD + N vs Frequency

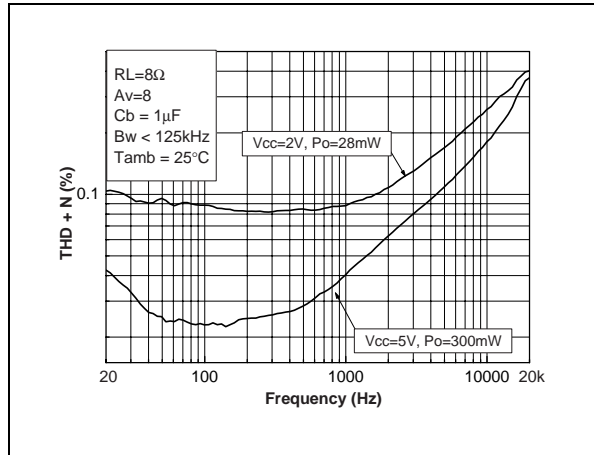

Fig. 87: THD + N vs Frequency

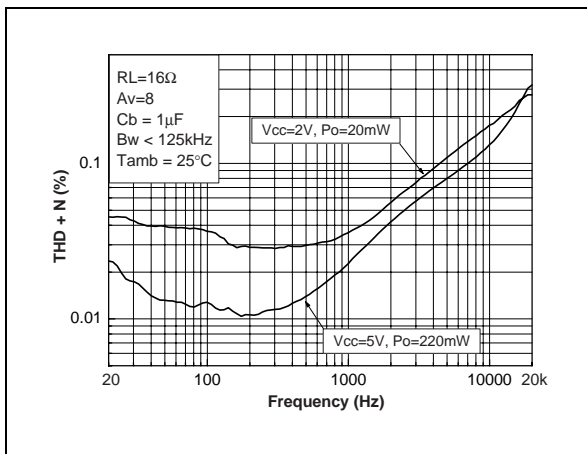

Fig. 88: THD + N vs Frequency

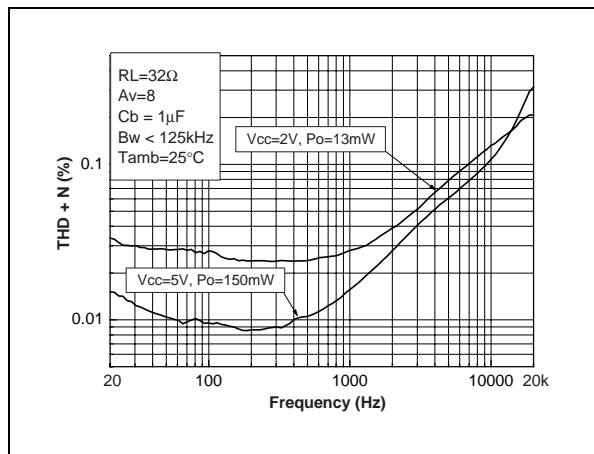

Fig. 89: Signal to Noise Ratio vs Power Supply Voltage with Unweighted Filter (20Hz to 20kHz)

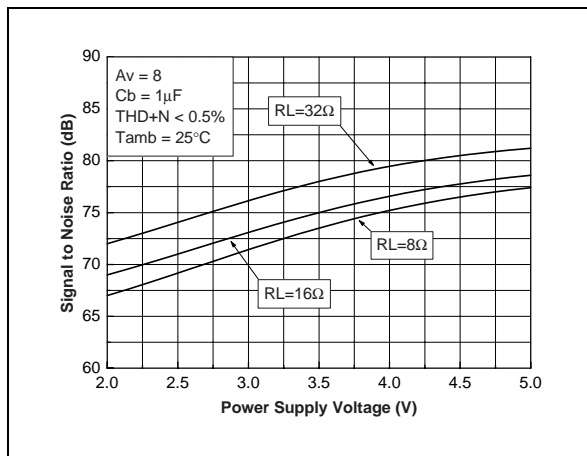

Fig. 90: Signal to Noise Ratio vs Power Supply Voltage with Weighted Filter Type A

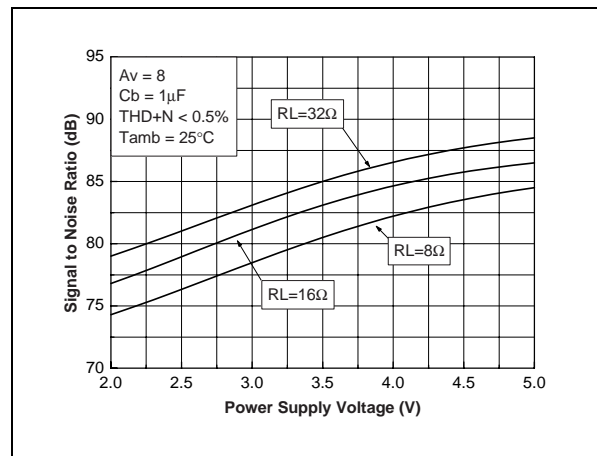

Fig. 91: Noise Floor

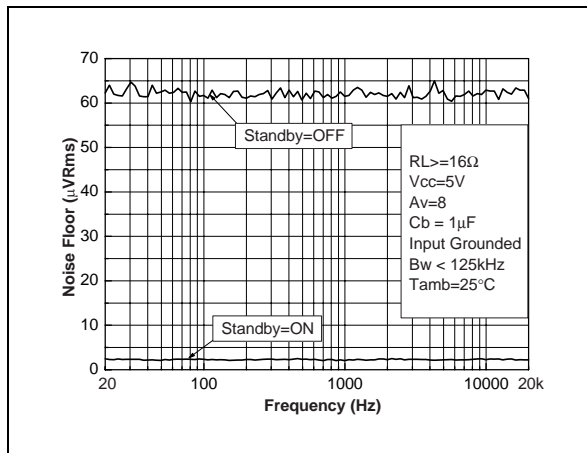

Fig. 92: Noise Floor

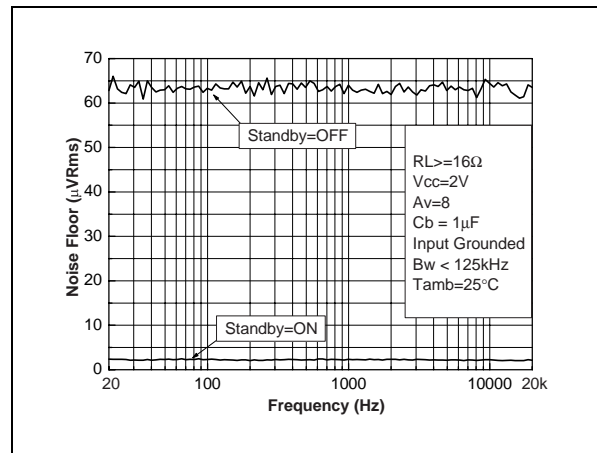

Fig. 93: PSRR vs Power Supply Voltage

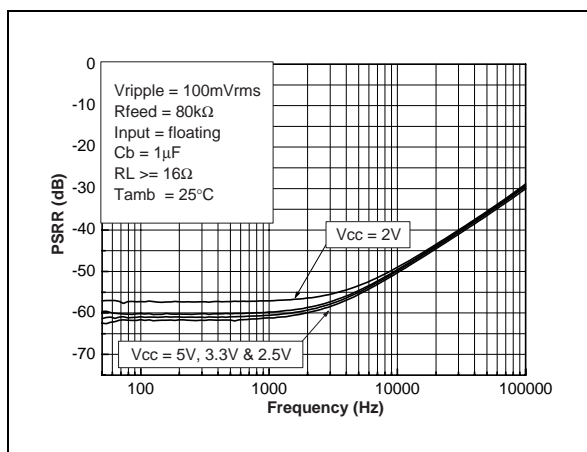

Fig. 94: PSRR vs Input Capacitor

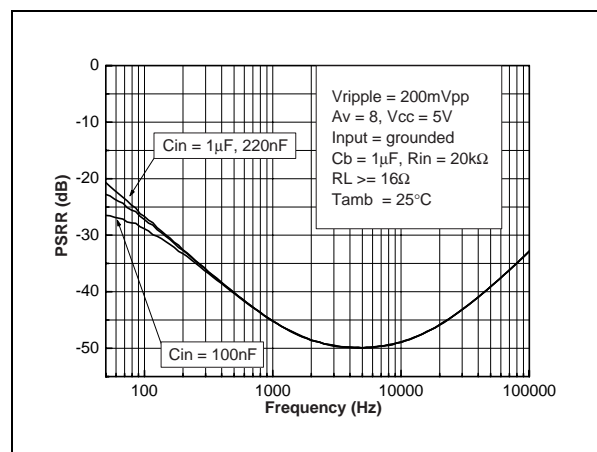

Fig. 95: PSRR vs Bypass Capacitor

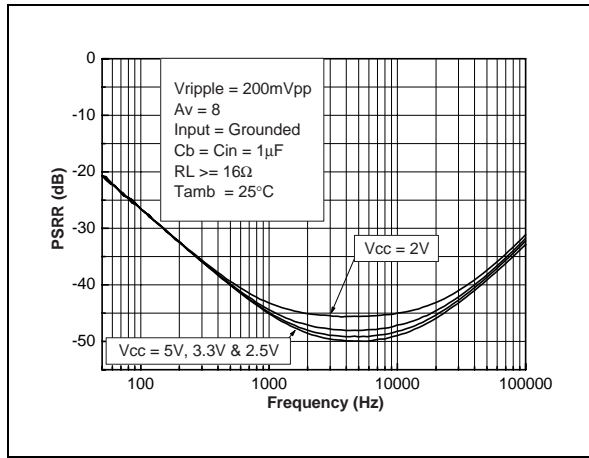

Fig. 96: PSRR vs Bypass Capacitor

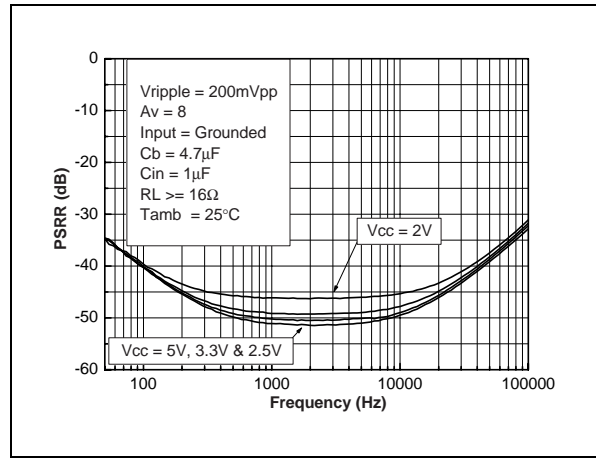
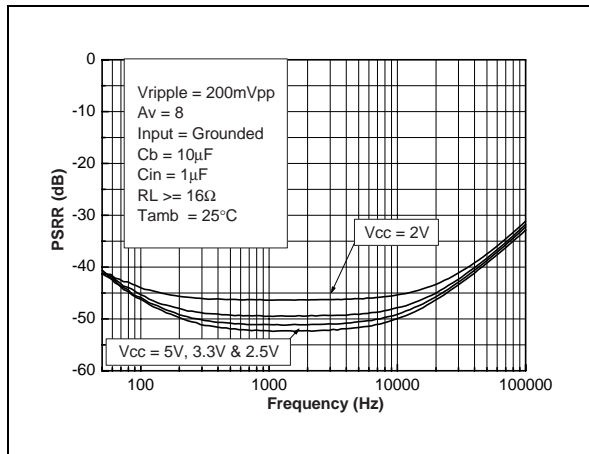

Fig. 97: PSRR vs Bypass Capacitor



APPLICATION INFORMATION

■ BTL Configuration Principle

The TS419 & TS420 are monolithic power amplifiers with a BTL output type. BTL (Bridge Tied Load) means that each end of the load is connected to two single-ended output amplifiers. Thus, we have:

Single ended output 1 = $V_{out1} = V_{out}$ (V)
 Single ended output 2 = $V_{out2} = -V_{out}$ (V)

And $V_{out1} - V_{out2} = 2V_{out}$ (V)

The output power is :

$$P_{out} = \frac{(2 V_{out_{RMS}})^2}{R_L} \text{ (W)}$$

For the same power supply voltage, the output power in BTL configuration is four times higher than the output power in single ended configuration.

■ Gain In Typical Application Schematic (cf. page 3 of TS419-TS421 datasheet)

In the flat region (no C_{IN} effect), the output voltage of the first stage is:

$$V_{out1} = -V_{in} \frac{R_{feed}}{R_{in}} \text{ (V)}$$

For the second stage : $V_{out2} = -V_{out1}$ (V)

The differential output voltage is

$$V_{out2} - V_{out1} = 2V_{in} \frac{R_{feed}}{R_{in}} \text{ (V)}$$

The differential gain named gain (G_v) for more convenient usage is :

$$G_v = \frac{V_{out2} - V_{out1}}{V_{in}} = 2 \frac{R_{feed}}{R_{in}}$$

Remark : V_{out2} is in phase with V_{in} and V_{out1} is phased 180° with V_{in} . This means that the positive terminal of the loudspeaker should be connected to V_{out2} and the negative to V_{out1} .

■ Low and high frequency response

In the low frequency region, C_{IN} starts to have an effect. C_{IN} forms with R_{IN} a high-pass filter with a -3dB cut off frequency .

$$F_{CL} = \frac{1}{2\pi R_{in} C_{in}} \text{ (Hz)}$$

In the high frequency region, you can limit the bandwidth by adding a capacitor (C_{feed}) in parallel with R_{feed} . It forms a low-pass filter with a -3dB cut off frequency .

$$F_{CH} = \frac{1}{2\pi R_{feed} C_{feed}} \text{ (Hz)}$$

■ Power dissipation and efficiency

Hypothesis:

- Load voltage and current are sinusoidal (V_{out} and I_{out})
- Supply voltage is a pure DC source (V_{cc})

Regarding the load we have:

$$V_{OUT} = V_{PEAK} \sin \omega t \text{ (V)}$$

and

$$I_{OUT} = \frac{V_{OUT}}{R_L} \text{ (A)}$$

and

$$P_{OUT} = \frac{V_{PEAK}^2}{2R_L} \text{ (W)}$$

Then, the average current delivered by the supply voltage is:

$$I_{CC_{AVG}} = 2 \frac{V_{PEAK}}{\pi R_L} \text{ (A)}$$

The power delivered by the supply voltage is:

$$P_{supply} = V_{cc} I_{CC_{AVG}} \text{ (W)}$$

Then, the **power dissipated by the amplifier** is:

$$P_{diss} = P_{supply} - P_{out} \text{ (W)}$$

$$P_{diss} = \frac{2\sqrt{2} V_{cc}}{\pi\sqrt{R_L}} \sqrt{P_{OUT}} - P_{OUT} \text{ (W)}$$

and the maximum value is obtained when:

$$\frac{\partial P_{diss}}{\partial P_{OUT}} = 0$$

and its value is:

$$P_{diss \max} = \frac{2V_{cc}^2}{\pi^2 R_L} \text{ (W)}$$

Remark : This maximum value is only dependent upon power supply voltage and load values.

The **efficiency** is the ratio between the output power and the power supply

$$\eta = \frac{P_{OUT}}{P_{supply}} = \frac{\pi V_{PEAK}}{4 V_{CC}}$$

The maximum theoretical value is reached when $V_{peak} = V_{CC}$, so

$$\frac{\pi}{4} = 78.5\%$$

■ Decoupling of the circuit

Two capacitors are needed to bypass properly the TS419/TS421. A power supply bypass capacitor C_S and a bias voltage bypass capacitor C_B .

C_S has particular influence on the THD+N in the high frequency region (above 7kHz) and an indirect influence on power supply disturbances. With $1\mu F$, you can expect similar THD+N performances to those shown in the datasheet.

In the high frequency region, if C_S is lower than $1\mu F$, it increases THD+N and disturbances on the power supply rail are less filtered.

On the other hand, if C_S is higher than $1\mu F$, those disturbances on the power supply rail are more filtered.

C_B has an influence on THD+N at lower frequencies, but its function is critical to the final result of PSRR (with input grounded and in the lower frequency region).

If C_B is lower than $1\mu F$, THD+N increases at lower frequencies and PSRR worsens.

If C_B is higher than $1\mu F$, the benefit on THD+N at lower frequencies is small, but the benefit to PSRR is substantial.

Note that C_{IN} has a non-negligible effect on PSRR at lower frequencies. The lower the value of C_{IN} , the higher the PSRR.

■ Wake-up Time: T_{WU}

When standby is released to put the device ON, the bypass capacitor C_B will not be charged immediately. As C_B is directly linked to the bias of the amplifier, the bias will not work properly until the C_B voltage is correct. The time to reach this voltage is called wake-up time or T_{WU} and typically equal to:

$$T_{WU} = 0.15 \times C_B \text{ (s) with } C_B \text{ in } \mu F.$$

Due to process tolerances, the range of the wake-up time is :

$$0.12 \times C_B < T_{WU} < 0.18 \times C_B \text{ (s) with } C_B \text{ in } \mu F$$

Note : When the standby command is set, the time to put the device in shutdown mode is a few microseconds.

■ Pop performance

Pop performance is intimately linked with the size of the input capacitor C_{IN} and the bias voltage bypass capacitor C_B .

The size of C_{IN} is dependent on the lower cut-off frequency and PSRR values requested. The size of C_B is dependent on THD+N and PSRR values requested at lower frequencies.

Moreover, C_B determines the speed with which the amplifier turns ON. The slower the speed is, the softer the turn ON noise is.

The charge time of C_B is directly proportional to the internal generator resistance $150k\Omega$.

Then, the charge time constant for C_B is

$$\tau_B = 150k\Omega \times C_B \text{ (s)}$$

As C_B is directly connected to the non-inverting input (pin 2 & 3) and if we want to minimize, in amplitude and duration, the output spike on V_{out1} (pin 5), C_{IN} must be charged faster than C_B . The equivalent charge time constant of C_{IN} is:

$$\tau_{IN} = (R_{in} + R_{feed}) \times C_{IN} \text{ (s)}$$

Thus we have the relation:

$$\tau_{IN} < \tau_B \text{ (s)}$$

Proper respect of this relation allows to minimize the pop noise.

Remark : Minimizing C_{IN} and C_B benefits both the pop phenomena, and the cost and size of the application.

■ Application : Differential inputs BTL power amplifier.

The schematic on figure 98, shows how to design the TS419/21 to work in a differential input mode.

The gain of the amplifier is: $G_{VDIFF} = 2 \frac{R_2}{R_1}$

In order to reach optimal performances of the differential function, R_1 and R_2 should be matched at 1% max.

Fig. 98 : Differential Input Amplifier Configuration

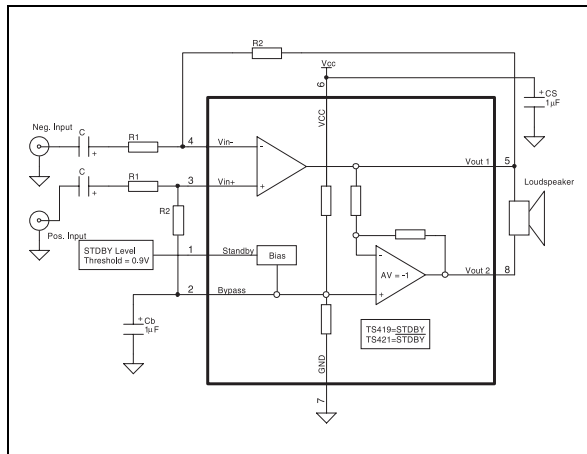

Input capacitance C can be calculated by the following formula using the -3dB lower frequency required. (F_L is the lower frequency required)

$$C \approx \frac{1}{2\pi R_1 F_L} (F)$$

Note : This formula is true only if:

$$F_{CB} = \frac{1}{942000 \times C_B} \text{ (Hz)}$$

is ten times lower than F_L .

The following bill of material is an example of a differential amplifier with a gain of 2 and a -3dB lower cutoff frequency of about 80Hz.

Components :

Designator	Part Type
R1	20k / 1%
R2	20k / 1%
C	100nF
$C_B=C_S$	1µF
U1	TS419/21

PACKAGE MECHANICAL DATA

SO-8 MECHANICAL DATA

DIM.	mm.			inch		
	MIN.	TYP.	MAX.	MIN.	TYP.	MAX.
A	1.35		1.75	0.053		0.069
A1	0.10		0.25	0.04		0.010
A2	1.10		1.65	0.043		0.065
B	0.33		0.51	0.013		0.020
C	0.19		0.25	0.007		0.010
D	4.80		5.00	0.189		0.197
E	3.80		4.00	0.150		0.157
e		1.27			0.050	
H	5.80		6.20	0.228		0.244
h	0.25		0.50	0.010		0.020
L	0.40		1.27	0.016		0.050
k	8° (max.)					
ddd			0.1			0.04

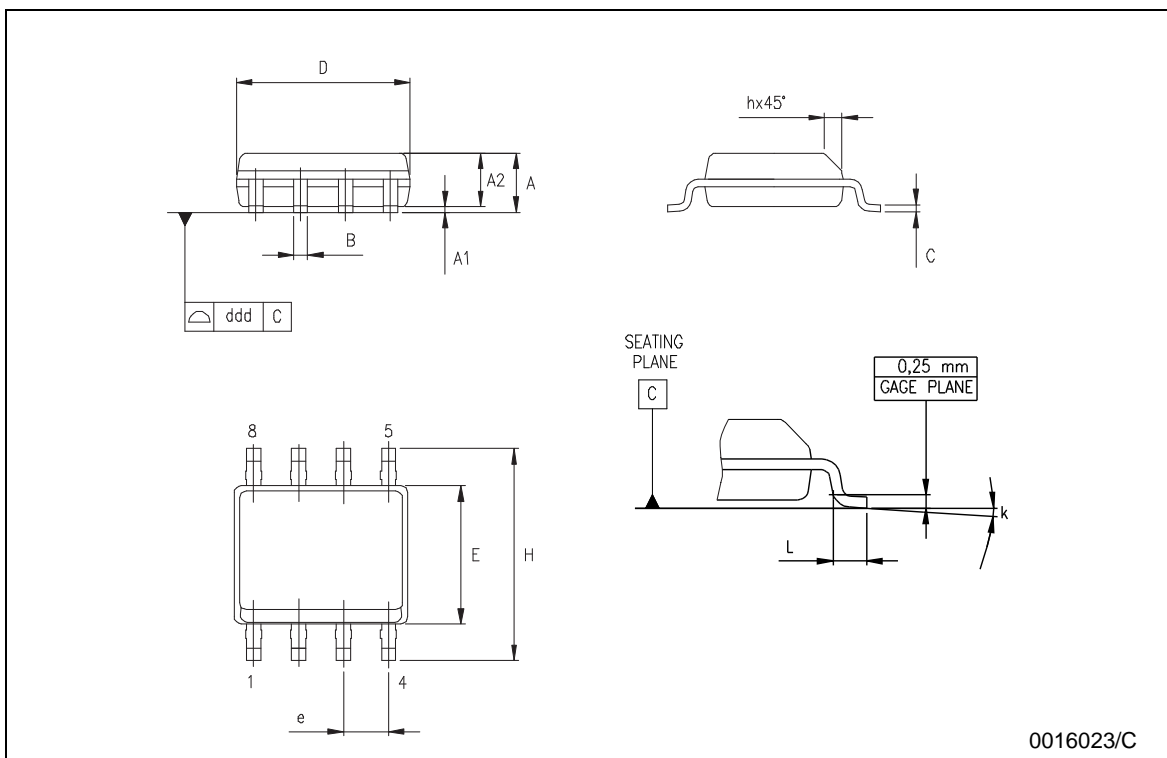

PACKAGE MECHANICAL DATA

miniSO-8 MECHANICAL DATA

DIM.	mm.			inch		
	MIN.	TYP	MAX.	MIN.	TYP.	MAX.
A			1.1			0.043
A1	0.05	0.10	0.15	0.002	0.004	0.006
A2	0.78	0.86	0.94	0.031	0.031	0.037
b	0.25	0.33	0.40	0.010	0.13	0.013
c	0.13	0.18	0.23	0.005	0.007	0.009
D	2.90	3.00	3.10	0.114	0.118	0.122
E	4.75	4.90	5.05	0.187	0.193	0.199
E1	2.90	3.00	3.10	.0114	0.118	0.122
e		0.65			0.026	
K	0°		6°	0°		6°
L	0.40	0.55	0.70	0.016	0.022	0.028
L1			0.10			0.004

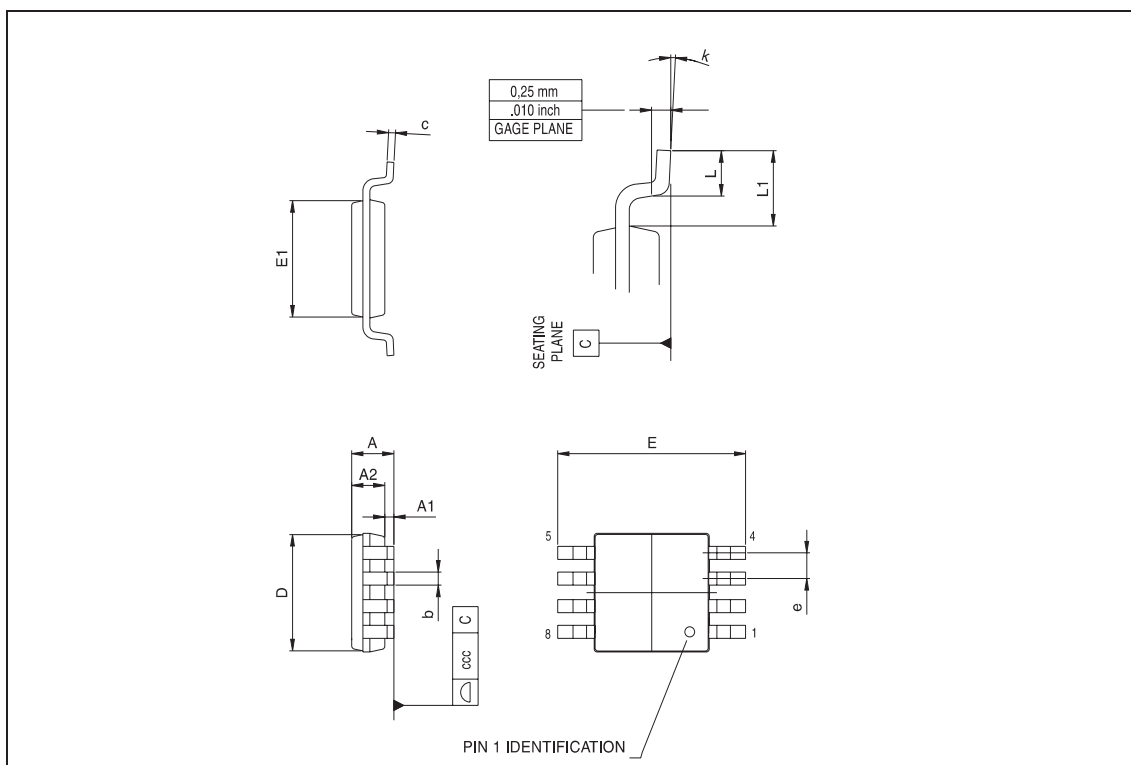

PACKAGE MECHANICAL DATA

DFN8 (3x3) MECHANICAL DATA

DIM.	mm.			inch		
	MIN.	TYP.	MAX.	MIN.	TYP.	MAX.
A	0.80	0.90	1.00	31.5	35.4	39.4
A1		0.02	0.05		0.8	2.0
A2		0.70			27.6	
A3		0.20			7.9	
b	0.18	0.23	0.30	7.1	9.1	11.8
D		3.00			118.1	
D2	2.23	2.38	2.48	87.8	93.7	97.7
E		3.00			118.1	
E2	1.49	1.64	1.74	58.7	64.6	68.5
e		0.50			19.7	
L	0.30	0.40	0.50	11.8	15.7	19.7

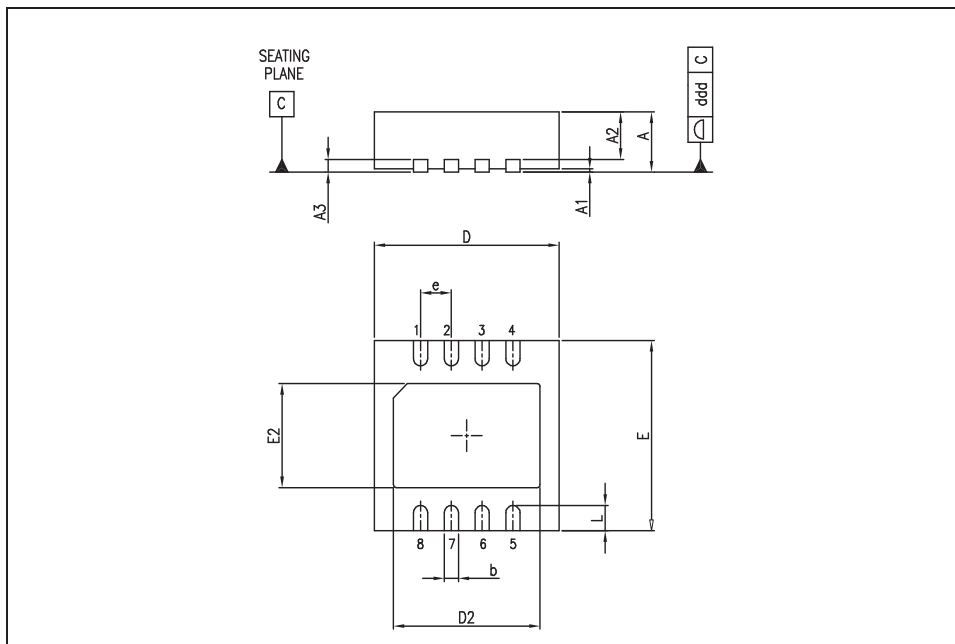

Information furnished is believed to be accurate and reliable. However, STMicroelectronics assumes no responsibility for the consequences of use of such information nor for any infringement of patents or other rights of third parties which may result from its use. No license is granted by implication or otherwise under any patent or patent rights of STMicroelectronics. Specifications mentioned in this publication are subject to change without notice. This publication supersedes and replaces all information previously supplied. STMicroelectronics products are not authorized for use as critical components in life support devices or systems without express written approval of STMicroelectronics.

The ST logo is a registered trademark of STMicroelectronics

© 2003 STMicroelectronics - Printed in Italy - All Rights Reserved
 STMicroelectronics GROUP OF COMPANIES

Australia - Brazil - Canada - China - Finland - France - Germany - Hong Kong - India - Israel - Italy - Japan - Malaysia
 Malta - Morocco - Singapore - Spain - Sweden - Switzerland - United Kingdom - United States

<http://www.st.com>