

# NTC Accurate Thermistors



## NJ 28 – NI 28 – NK 20

High precision resistance and an outstanding ability to reproduce the sensibility index B, make these ranges of products the types of thermistors ideal for temperature measurement applications.

Leaded or unled, these small size and rapid response time thermistors are able to meet the most accurate requirements.

Types	NJ 28	NI 28	NK 20
Finish	Coated chip with phenolic resin + varnish	Coated chip with epoxy insulated leads	Chip
<b>DIMENSIONS:</b> millimeters (inches)			
Marking	On packaging only		
Operating temperature	-55°C to +150°C		
Tolerance on R <sub>n</sub> (25°C)	±1%, ±2%, ±3%		
Maximum dissipation at 25°C	0.16 W		
Thermal dissipation factor*	3 mW/°C	3 mW/°C	2 mW/°C
Thermal time constant	8 s	8 s	6 s
Response time	< 2 s		

### TABLE OF VALUES

Types	R <sub>n</sub> at 25°C (Ω)	Material Code	B (K)	α at 25°C (%/°C)
N■ 28 KA 0202	2,000	KA	3625 ± 1%	- 4.1
N■ 28 MA 0302	3,000	MA	3960 ± 0.5%	- 4.5
N■ 28 MA 0502	5,000	MA	3960 ± 0.5%	- 4.5
N■ 28 NA 0103	10,000	NA	4100 ± 1%	- 4.6
N■ 28 PA 0203	20,000	PA	4235 ± 1%	- 4.8
N■ 28 QA 0503	50,000	QA	4250 ± 1%	- 4.8
N■ 28 RA 0104	100,000	RA	4380 ± 1%	- 4.9

- = J for non-insulated leads
- = I for insulated leads
- = K for marked chip

Resistance - Temperature characteristics: pages 32 to 35.

### HOW TO ORDER

**NJ28**  
|  
Type

**MA**  
|  
Material Code  
MA  
(See table above)

**0502**  
|  
Resistance  
5 kΩ

**F--**  
|  
Tolerance  
F (±1%)

# NTC Thermistors Manufacturing Process

NJ 28 – NI 28 – NK 20

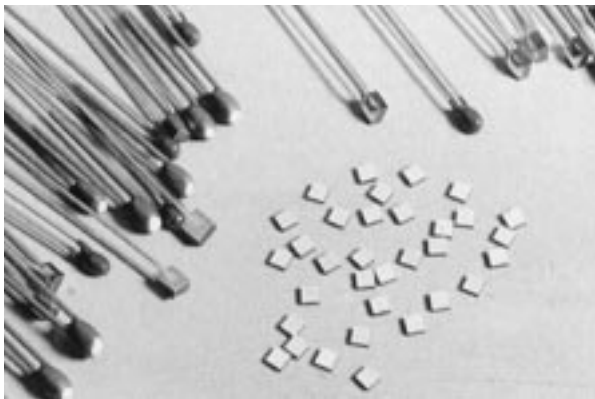
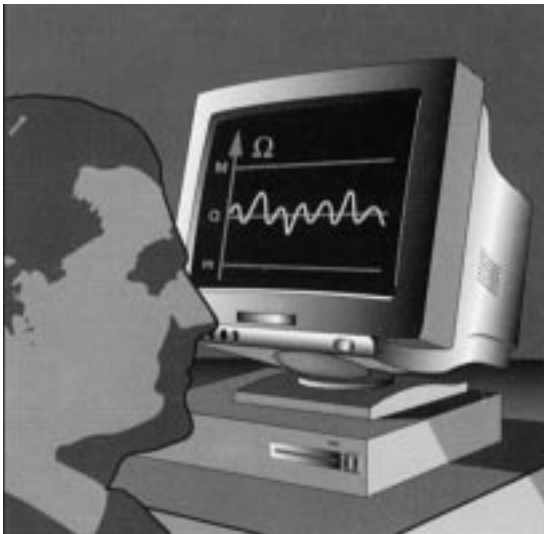
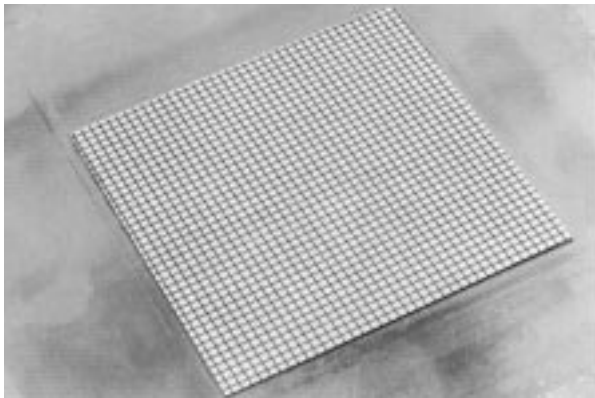
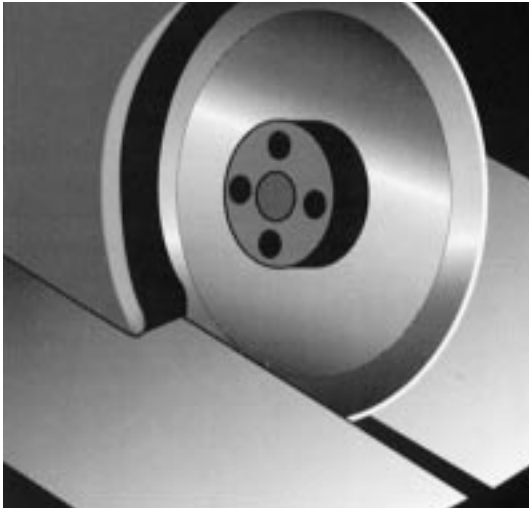
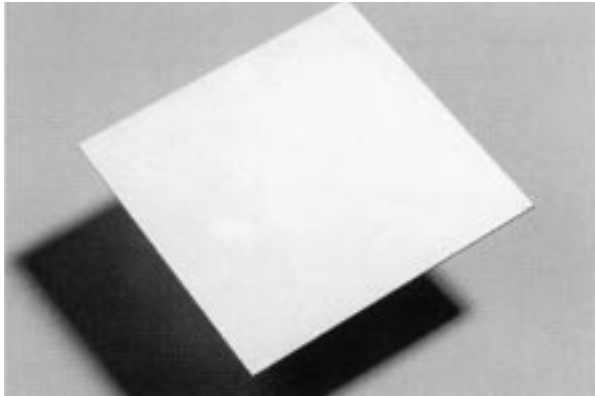
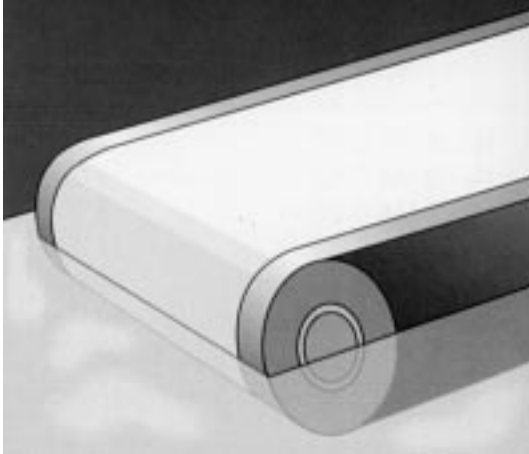

TPC

# Resistance



## Temperature Characteristics

T (°C)	Material code B (K)									T (°C)
	F 2800			G 3030			H 3160			
	R (T) / R25	TF (%)	α (%/°C)	R (T) / R25	TF (%)	α (%/°C)	R (T) / R25	TF (%)	α (%/°C)	
-55	29.51	27.5	5.81	33.43	29.7	5.81	38.50	31.0	6.03	-55
-50	22.33	23.7	5.56	25.27	25.7	5.59	28.80	26.8	5.81	-50
-45	17.09	20.4	5.33	19.29	22.1	5.39	21.76	23.0	5.60	-45
-40	13.12	17.4	5.11	14.87	18.9	5.20	16.60	19.7	5.41	-40
-35	10.45	14.8	4.90	11.56	16.0	5.02	12.78	16.7	5.22	-35
-30	8.160	12.5	4.71	9.069	13.5	4.84	9.930	14.1	5.04	-30
-25	6.499	10.4	4.52	7.171	11.3	4.68	7.779	11.8	4.87	-25
-20	5.221	8.6	4.35	5.715	9.3	4.52	6.143	9.7	4.70	-20
-15	4.228	7.0	4.19	4.589	7.6	4.37	4.889	7.9	4.55	-15
-10	3.450	5.6	4.03	3.711	6.1	4.22	3.919	6.3	4.40	-10
-5	2.836	4.4	3.89	3.021	4.7	4.09	3.164	4.9	4.26	-5
0	2.348	3.3	3.75	2.476	3.6	3.96	2.572	3.7	4.12	0
5	1.956	2.4	3.62	2.042	2.6	3.83	2.104	2.7	3.99	5
10	1.640	1.6	3.49	1.694	1.8	3.71	1.732	1.8	3.87	10
15	1.383	1.0	3.38	1.413	1.1	3.60	1.434	1.1	3.75	15
20	1.173	.4	3.26	1.186	.5	3.49	1.194	.5	3.63	20
25	1.0000	0.0	3.16	1.0000	0.0	3.38	1.0000	0.0	3.53	25
30	.8570	.4	3.06	.8476	.5	3.28	.8417	.5	3.42	30
35	.7381	.9	2.96	.7220	1.0	3.18	.7121	1.0	3.32	35
40	.6386	1.4	2.87	.6178	1.6	3.09	.6053	1.6	3.22	40
45	.5550	2.0	2.78	.5310	2.2	3.00	.5169	2.3	3.13	45
50	.4844	2.7	2.69	.4584	2.9	2.92	.4434	3.0	3.04	50
55	.4245	3.3	2.61	.3973	3.6	2.83	.3820	3.7	2.96	55
60	.3734	4.0	2.54	.3458	4.3	2.76	.3305	4.5	2.87	60
65	.3297	4.7	2.46	.3021	5.1	2.68	.2870	5.3	2.80	65
70	.2922	5.5	2.39	.2648	5.9	2.61	.2502	6.2	2.72	70
75	.2598	6.3	2.33	.2330	6.8	2.54	.2189	7.1	2.65	75
80	.2318	7.1	2.26	.2057	7.6	2.47	.1923	8.0	2.58	80
85	.2074	7.9	2.20	.1822	8.5	2.40	.1694	8.9	2.51	85
90	.1861	8.7	2.14	.1619	9.4	2.34	.1498	9.8	2.44	90
95	.1676	9.5	2.08	.1443	10.3	2.38	.1328	10.8	2.38	95
100	.1513	10.4	2.03	.1290	11.2	2.22	.1181	11.7	2.32	100
105	.1369	11.2	1.97	.1156	12.2	2.17	.1054	12.7	2.26	105
110	.1242	12.1	1.92	.1039	13.1	2.11	.09430	13.7	2.21	110
115	.1130	13.0	1.87	.09365	14.0	2.06	.08460	14.6	2.15	115
120	.1030	13.9	1.83	.08461	15.0	2.01	.07610	15.6	2.10	120
125	.09417	14.7	1.78	.07663	15.9	1.96	.06863	16.6	2.05	125
130	.08625	15.6	1.74	.06957	16.9	1.92	.06204	17.6	2.00	130
135	.07917	16.5	1.70	.06330	17.9	1.87	.05623	18.6	1.95	135
140	.07282	17.4	1.66	.05772	18.8	1.83	.05107	19.6	1.91	140
145	.06711	18.3	1.62	.05275	19.8	1.78	.04649	20.6	1.86	145
150	.06197	19.2	1.58	.04831	20.7	1.74	.04242	21.6	1.82	150

T (°C)	Material code B (K)									T (°C)
	I 3250			J-J5 3480			K 3630			
	R (T) / R25	TF (%)	α (%/°C)	R (T) / R25	TF (%)	α (%/°C)	R (T) / R25	TF (%)	α (%/°C)	
-55	42.35	21.9	5.98	51.74	34.1	6.43	56.26	35.6	6.46	-55
-50	31.48	20.0	5.78	37.97	29.5	6.21	41.21	30.8	6.26	-50
-45	23.63	18.1	5.59	28.15	25.3	6.01	30.47	26.4	6.06	-45
-40	17.91	16.3	5.41	21.07	21.7	5.81	22.73	22.6	5.88	-40
-35	13.70	14.6	5.23	15.91	18.4	5.62	17.11	19.2	5.70	-35
-30	10.58	13.1	5.06	12.13	15.5	5.44	12.98	16.2	5.53	-30
-25	8.232	11.6	4.90	9.320	12.9	5.26	9.930	13.5	5.36	-25
-20	6.460	10.1	4.74	7.221	10.7	5.10	7.654	11.2	5.21	-20
-15	5.110	8.8	4.59	5.640	8.7	4.94	5.945	9.1	5.05	-15
-10	4.072	7.5	4.45	4.438	7.0	4.78	4.650	7.3	4.91	-10
-5	3.268	6.3	4.31	3.517	5.4	4.64	3.663	5.7	4.76	-5
0	2.641	5.1	4.18	2.807	4.1	4.50	2.905	4.3	4.63	0
5	2.148	4.0	4.05	2.255	3.0	4.36	2.319	3.1	4.50	5
10	1.759	2.9	3.92	1.824	2.0	4.23	1.862	2.1	4.37	10
15	1.449	1.9	3.81	1.484	1.2	4.10	1.505	1.3	4.25	15
20	1.200	0.9	3.69	1.215	.5	3.98	1.223	.6	4.13	20
25	1.000	0.0	3.58	1.0000	0.0	3.87	1.0000	0.0	4.01	25
30	0.8377	0.9	3.48	.8278	.5	3.76	.8219	.6	3.90	30
35	0.7054	1.8	3.38	.6889	1.1	3.65	.6792	1.2	3.80	35
40	0.5969	2.6	3.28	.5763	1.8	3.55	.5641	1.9	3.69	40
45	0.5076	3.5	3.19	.4845	2.5	3.45	.4708	2.6	3.59	45
50	0.4336	4.3	3.10	.4092	3.3	3.35	.3949	3.4	3.50	50
55	0.3720	5.1	3.01	.3473	4.1	3.26	.3327	4.3	3.41	55
60	0.3206	5.9	2.93	.2960	5.0	3.17	.2816	5.2	3.32	60
65	0.2774	6.6	2.85	.2534	5.9	3.09	.2393	6.1	3.23	65
70	0.2410	7.4	2.77	.2178	6.8	3.01	.2043	7.1	3.14	70
75	0.2102	8.1	2.70	.1879	7.8	2.93	.1751	8.1	3.06	75
80	0.1839	8.8	2.63	.1628	8.8	2.85	.1507	9.1	2.99	80
85	0.1616	9.5	2.56	.1415	9.8	2.78	.1301	10.2	2.91	85
90	0.1424	10.2	2.49	.1235	10.8	2.70	.1128	11.3	2.84	90
95	0.1259	10.9	2.43	.1081	11.8	2.64	.09812	12.4	2.77	95
100	0.1117	11.5	2.36	.09500	12.9	2.57	.08565	13.5	2.70	100
105	0.09938	12.2	2.30	.08373	14.0	2.50	.07502	14.6	2.63	105
110	0.08869	12.8	2.25	.07403	15.0	2.44	.06592	15.7	2.57	110
115	0.07938	13.4	2.19	.06565	16.1	2.38	.05810	16.8	2.50	115
120	0.07124	14.0	2.14	.05838	17.2	2.33	.05137	18.0	2.44	120
125	0.06410	14.6	2.08	.05207	18.3	2.27	.04555	19.1	2.39	125
130	0.05783	15.2	2.03	.04567	19.4	2.22	.04050	20.3	2.33	130
135	0.05230	15.7	1.98	.04175	20.5	2.16	.03611	21.4	2.27	135
140	0.04741	16.3	1.94	.03753	21.6	2.11	.03229	22.5	2.22	140
145	0.04308	16.8	1.89	.03382	22.7	2.06	.02894	23.7	2.17	145
150	0.03924	17.4	1.85	.03055	23.8	2.02	.02600	24.9	2.12	150

# Resistance



## Temperature Characteristics

T (°C)	Material code B (K)									T (°C)
	L 3790			M 3950			N 4080			
	R (T) / R25	TF (%)	α (%/°C)	R (T) / R25	TF (%)	α (%/°C)	R (T) / R25	TF (%)	α (%/°C)	
-55	82.52	22.3	7.38	99.56	23.2	7.71	110.1	24.0	7.81	-55
-50	58.01	19.3	7.11	68.95	20.1	7.42	75.90	20.7	7.53	-50
-45	41.30	16.6	6.84	48.38	17.3	7.15	52.98	17.8	7.26	-45
-40	29.75	14.2	6.60	34.37	14.8	6.89	37.43	15.2	7.01	-40
-35	21.67	12.0	6.36	24.71	12.5	6.64	26.75	12.9	6.77	-35
-30	15.96	10.1	6.13	17.96	10.6	6.41	19.33	10.9	6.54	-30
-25	11.88	8.5	5.92	13.20	8.8	6.18	14.12	9.1	6.32	-25
-20	8.930	7.0	5.72	9.803	7.3	5.97	10.41	7.5	6.10	-20
-15	6.776	5.7	5.32	7.351	5.9	5.77	7.758	6.1	5.90	-15
-10	5.188	4.5	5.34	5.585	4.7	5.57	5.834	4.9	5.71	-10
-5	4.007	3.6	5.16	4.251	3.7	5.39	4.426	3.8	5.53	-5
0	3.120	2.7	4.99	3.275	2.8	5.21	3.387	2.9	5.35	0
5	2.449	2.0	4.83	2.544	2.0	5.04	2.614	2.1	5.18	5
10	1.937	1.3	4.68	1.992	1.4	4.88	2.033	1.4	5.02	10
15	1.543	.8	4.53	1.572	.8	4.73	1.593	.9	4.87	15
20	1.238	.4	4.39	1.249	.4	4.58	1.258	.4	4.72	20
25	1.0000	0.0	4.25	1.0000	0.0	4.44	1.0000	0.0	4.57	25
30	.8129	.3	4.12	.8057	.4	4.30	.8004	.4	4.44	30
35	.6648	.7	4.00	.6534	.8	4.17	.6448	.8	4.31	35
40	.5409	1.2	3.88	.5331	1.2	4.05	.5228	1.3	4.18	40
45	.4525	1.6	3.77	.4376	1.7	3.93	.4264	1.8	4.06	45
50	.3765	2.2	3.66	.3612	2.2	3.81	.3497	2.3	3.94	50
55	.3148	2.7	3.55	.2998	2.8	3.71	.2885	2.9	3.83	55
60	.2646	3.3	3.45	.2501	3.4	3.60	.2392	3.5	3.72	60
65	.2235	3.8	3.36	.2097	4.0	3.50	.1994	4.1	3.62	65
70	.1896	4.5	3.26	.1767	4.6	3.40	.1671	4.8	3.52	70
75	.1616	5.1	3.17	.1496	5.3	3.31	.1406	5.5	3.42	75
80	.1383	5.7	3.09	.1272	6.0	3.22	.1189	6.2	3.33	80
85	.1189	6.4	3.00	.1087	6.7	3.13	.1010	6.9	3.24	85
90	.1026	7.1	2.92	.09321	7.4	3.05	.08617	7.6	3.16	90
95	.08889	7.7	2.85	.08027	8.1	2.97	.07381	8.3	3.07	95
100	.07729	8.4	2.77	.06939	8.8	2.89	.06347	9.1	2.99	100
105	.06745	9.1	2.70	.06020	9.5	2.82	.05480	9.8	2.92	105
110	.05906	9.8	2.63	.05243	10.2	2.75	.04148	10.6	2.84	110
115	.05189	10.5	2.57	.04581	11.0	2.68	.04129	11.3	2.77	115
120	.04573	11.3	2.50	.04017	11.7	2.61	.03603	12.1	2.70	120
125	.04043	12.0	2.44	.03533	12.5	2.55	.03155	12.9	2.64	125
130	.03585	12.7	2.38	.03117	13.2	2.48	.02771	13.7	2.57	130
135	.03188	13.4	2.33	.02759	14.0	2.42	.02442	14.4	2.51	135
140	.02843	14.1	2.27	.02449	14.7	2.37	.02158	15.2	2.45	140
145	.02543	14.8	2.22	.02180	15.5	2.31	.01913	16.0	2.39	145
150	.02279	15.6	2.17	.01945	16.2	2.26	.01700	16.8	2.34	150

T (°C)	Material code B (K)									T (°C)
	P 4220			Q 4300			R 4400			
	R (T) / R25	TF (%)	α (%/°C)	R (T) / R25	TF (%)	α (%/°C)	R (T) / R25	TF (%)	α (%/°C)	
-55	121.3	24.8	7.88	98.02	25.5	7.14	113.9	25.9	7.42	-55
-50	83.32	21.4	7.61	69.51	22.0	6.95	79.69	22.4	7.22	-50
-45	57.91	18.4	7.36	49.72	18.9	6.77	56.29	19.2	7.03	-45
-40	40.71	15.8	7.11	35.86	16.2	6.59	40.12	16.4	6.84	-40
-35	28.95	13.4	6.88	26.08	13.7	6.42	28.85	14.0	6.66	-35
-30	20.80	11.3	6.66	19.12	11.6	6.26	20.92	11.8	6.48	-30
-25	15.10	9.4	6.44	14.12	9.7	6.10	15.29	9.8	6.31	-25
-20	11.07	7.8	6.24	10.51	8.0	5.94	11.27	8.1	6.14	-20
-15	8.196	6.3	6.04	7.876	6.5	5.79	8.367	6.6	5.98	-15
-10	6.123	5.1	5.85	5.946	5.2	5.64	6.260	5.3	5.83	-10
-5	4.615	4.0	5.67	4.520	4.1	5.50	4.719	4.1	5.67	-5
0	3.507	3.0	5.49	3.460	3.1	5.36	3.583	3.1	5.53	0
5	2.688	2.2	5.33	2.666	2.2	5.23	2.739	2.3	5.38	5
10	2.078	1.5	5.16	2.067	1.5	5.09	2.108	1.5	5.24	10
15	1.616	.9	5.01	1.613	.9	4.96	1.634	.9	5.11	15
20	1.267	.4	4.86	1.266	.4	4.84	1.274	.4	4.97	20
25	1.0000	0.0	4.72	1.0000	0.0	4.72	1.0000	0.0	4.84	25
30	.7949	.4	4.58	.7944	.4	4.60	.7897	.4	4.72	30
35	.6360	.8	4.45	.6347	.8	4.48	.6273	.9	4.60	35
40	.5120	1.3	4.32	.5099	1.3	4.37	.5012	1.4	4.48	40
45	.4148	1.8	4.20	.4119	1.9	4.26	.4026	1.9	4.36	45
50	.3380	2.4	4.06	.3345	2.5	4.15	.3255	2.5	4.25	50
55	.2769	3.0	3.96	.2730	3.1	4.05	.2644	3.1	4.14	55
60	.2282	3.6	3.86	.2239	3.7	3.95	.2159	3.8	4.04	60
65	.1890	4.3	3.75	.1846	4.4	3.85	.1772	4.5	3.03	65
70	.1573	5.0	3.65	.1529	5.1	3.75	.1462	5.2	3.83	70
75	.1316	5.7	3.55	.1272	5.8	3.66	.1212	5.9	3.74	75
80	.1106	6.4	3.45	.1063	6.5	3.57	.1009	6.7	3.64	80
85	.09338	7.1	3.36	.08928	7.3	3.48	.08441	7.4	3.55	85
90	.07919	7.9	3.28	.07527	8.1	3.39	.07093	8.2	3.46	90
95	.06744	8.6	3.19	.06373	8.8	3.31	.05985	9.0	3.38	95
100	.05767	9.4	3.11	.05417	9.6	3.23	.05072	9.8	3.29	100
105	.04951	10.2	3.03	.04623	10.4	3.15	.04315	10.6	3.21	105
110	.04267	10.9	2.95	.03961	11.2	3.07	.03686	11.4	3.13	110
115	.03691	11.7	2.88	.03405	12.0	3.00	.03160	12.2	3.06	115
120	.03204	12.5	2.81	.02939	12.9	2.93	.02720	13.1	2.98	120
125	.02791	13.3	2.74	.02545	13.7	2.86	.02349	13.9	2.91	125
130	.02440	14.1	2.67	.02211	14.5	2.79	.02036	14.7	2.84	130
135	.02139	14.9	2.61	.01928	15.3	2.72	.01771	15.6	2.77	135
140	.01882	15.7	2.55	.01686	16.1	2.66	.01545	16.4	2.71	140
145	.01660	16.5	2.49	.01479	17.0	2.60	.01353	17.2	2.64	145
150	.01469	17.3	2.43	.01302	17.8	2.54	.01188	18.1	2.58	150

# Resistance

## Temperature Characteristics



T (°C)	Material code B (K)									T (°C)
	S 4520			T 4630			U 4840			
	R (T) / R25	TF (%)	$\alpha$ (%/°C)	R (T) / R25	TF (%)	$\alpha$ (%/°C)	R (T) / R25	TF (%)	$\alpha$ (%/°C)	
-55	126.1	26.6	7.55	137.0	27.2	7.64	173.7	28.5	8.04	-55
-50	87.73	23.0	7.35	94.92	23.5	7.45	118.2	24.6	7.83	-50
-45	61.59	19.8	7.16	66.34	20.2	7.26	81.16	21.2	7.63	-45
-40	43.62	16.9	6.97	46.77	17.3	7.09	56.25	18.1	7.44	-40
-35	31.17	14.3	6.79	33.25	14.7	6.90	39.33	15.4	7.25	-35
-30	22.45	12.1	6.62	23.83	12.4	6.72	27.74	12.9	7.07	-30
-25	16.31	10.1	6.45	17.22	10.3	6.56	19.73	10.8	6.89	-25
-20	11.94	8.3	6.28	12.54	8.5	6.39	14.15	8.9	6.71	-20
-15	8.808	6.8	6.12	9.205	6.9	6.23	10.23	7.3	6.54	-15
-10	6.548	5.4	5.96	6.806	5.6	6.08	7.456	5.8	6.38	-10
-5	4.904	4.2	5.81	5.069	4.3	5.92	5.475	4.5	6.22	-5
0	3.699	3.2	5.66	3.803	3.3	5.78	4.051	3.4	6.06	0
5	2.810	2.3	5.52	2.873	2.4	5.63	3.019	2.5	5.91	5
10	2.149	1.6	5.38	2.185	1.6	5.49	2.267	1.7	5.76	10
15	1.654	1.0	5.24	1.673	1.0	5.35	1.714	1.0	5.61	15
20	1.282	.4	5.10	1.289	.4	5.22	1.305	.5	5.47	20
25	1.0000	0.0	4.97	1.0000	0.0	5.09	1.0000	0.0	5.33	25
30	.7848	.4	4.85	.7805	.4	4.96	.7715	.4	5.20	30
35	.6196	.9	4.72	.6129	.9	4.83	.5991	.9	5.06	35
40	.4922	1.4	4.60	.4842	1.4	4.71	.4681	1.5	4.94	40
45	.3932	2.0	4.48	.3847	2.0	4.59	.3681	2.1	4.81	45
50	.3158	2.6	4.37	.3074	2.6	4.48	.2911	2.8	4.69	50
55	.2551	3.2	4.26	.2470	3.3	4.37	.2316	3.4	4.57	55
60	.2072	3.9	4.15	.1996	4.0	4.26	.1853	4.2	4.45	60
65	.1691	4.6	4.05	.1621	4.7	4.15	.1491	4.9	4.34	65
70	.1387	5.3	3.94	.1323	5.4	4.04	.1207	5.7	4.23	70
75	.1144	6.1	3.84	.1086	6.2	3.94	.09813	6.5	4.12	75
80	.09477	6.8	3.75	.08953	7.0	3.84	.08023	7.3	4.02	80
85	.07888	7.6	3.65	.07417	7.8	3.75	.06592	8.2	3.91	85
90	.06595	8.4	3.56	.06173	8.6	3.65	.05443	9.0	3.82	90
95	.05539	9.2	3.47	.05161	9.5	3.56	.04515	9.9	3.72	95
100	.04671	10.1	3.39	.04334	10.3	3.47	.03763	10.8	3.63	100
105	.03956	10.9	3.30	.03655	11.2	3.39	.03151	11.7	3.54	105
110	.03364	11.7	3.22	.03095	12.0	3.31	.02650	12.6	3.45	110
115	.02872	12.6	3.14	.02632	12.9	3.22	.02237	13.5	3.38	115
120	.02461	13.4	3.07	.02247	13.7	3.15	.01897	14.4	3.28	120
125	.02117	14.3	2.99	.01925	14.6	3.07	.01615	15.3	3.20	125
130	.01828	15.1	2.92	.01656	15.5	2.99	.01381	16.2	3.12	130
135	.01584	16.0	2.85	.01429	16.4	2.92	.01185	17.1	3.04	135
140	.01376	16.8	2.78	.01238	17.3	2.85	.01020	18.0	2.97	140
145	.01201	17.7	2.72	.01076	18.1	2.78	.00882	19.0	2.90	145
150	.01050	18.6	2.65	.00938	19.0	2.72	.00765	19.9	2.83	150

T (°C)	Material code B (K)									T (°C)
	KC 3470			MC 3910			N5			
	R (T) / R25	TF (%)	$\alpha$ (%/°C)	R (T) / R25	TF (%)	$\alpha$ (%/°C)	R (T) / R25	TF (%)	$\alpha$ (%/°C)	
-55	60.08	34.0	7.00	100.6	38.3	7.88	115.8	16.3	7.83	-55
-50	43.19	29.4	6.71	69.29	33.1	7.55	79.70	14.1	7.56	-50
-45	31.42	25.3	6.44	48.41	28.5	7.24	55.53	12.1	7.30	-45
-40	23.13	21.6	6.18	34.27	24.3	6.96	39.14	10.4	7.06	-40
-35	17.22	18.4	5.94	24.57	20.7	6.68	27.90	8.8	6.82	-35
-30	12.95	15.5	5.71	17.83	17.4	6.42	20.11	7.4	6.60	-30
-25	9.842	12.9	5.49	13.09	14.5	6.18	14.64	6.2	6.38	-25
-20	7.550	10.7	5.29	9.714	12.0	5.95	10.77	5.1	6.17	-20
-15	5.845	8.7	5.10	7.283	9.8	5.73	7.995	4.2	5.97	-15
-10	4.564	6.9	4.91	5.515	7.8	5.53	5.991	3.3	5.78	-10
-5	3.594	5.4	4.74	4.215	6.1	5.33	4.529	2.6	5.60	-5
0	2.853	4.1	4.58	3.251	4.6	5.15	3.453	2.0	5.43	0
5	2.281	3.0	4.42	2.528	3.4	4.97	2.655	1.4	5.26	5
10	1.838	2.0	4.27	1.983	2.3	4.80	2.057	1.0	5.10	10
15	1.491	1.2	4.13	1.567	1.4	4.65	1.606	.6	4.95	15
20	1.217	0.5	4.00	1.247	0.6	4.49	1.263	.3	4.80	20
25	1.0000	0.0	3.90	1.0000	0.0	4.40	1.0000	0.0	4.65	25
30	0.8267	0.5	3.74	0.8072	0.6	4.21	.7973	.3	4.52	30
35	0.6873	1.1	3.63	0.6558	1.3	4.08	.6398	.5	4.39	35
40	0.5747	1.8	3.52	0.5361	2.0	3.96	.5167	.9	4.26	40
45	0.4830	2.5	3.41	0.4409	2.8	3.84	.4198	1.2	4.14	45
50	0.4081	3.3	3.31	0.3647	3.7	3.72	.3430	1.6	4.02	50
55	0.3465	4.1	3.21	0.3033	4.6	3.61	.2819	2.0	3.91	55
60	0.2955	5.0	3.12	0.2535	5.6	3.51	.2329	2.4	3.80	60
65	0.2532	5.9	3.03	0.2130	6.6	3.41	.1934	2.8	3.69	65
70	0.2179	6.8	2.94	0.1798	7.7	3.31	.1615	3.3	3.59	70
75	0.1883	7.8	2.86	0.1525	8.7	3.22	.1354	3.7	3.50	75
80	0.1634	8.7	2.78	0.1299	9.9	3.13	.1141	4.2	3.40	80
85	0.1423	9.7	2.71	0.1112	11.0	3.05	.09660	4.7	3.31	85
90	0.12441	10.8	2.63	0.09551	12.1	2.97	.08212	5.2	3.23	90
95	0.10915	11.8	2.56	0.08238	13.3	2.89	.07011	5.7	3.14	95
100	0.09608	12.9	2.50	0.07132	14.5	2.81	.06010	6.2	3.06	100
105	0.08486	13.9	2.43	0.06198	15.7	2.74	.05172	6.7	2.98	105
110	0.07519	15.0	2.37	0.05405	16.9	2.67	.04467	7.2	2.91	110
115	0.06683	16.1	2.31	0.04730	18.1	2.60	.03873	7.7	2.83	115
120	0.05957	17.2	2.25	0.04153	19.3	2.54	.03370	8.2	2.76	120
125	0.05325	18.3	2.20	0.03657	20.6	2.48	.02942	8.8	2.70	125
130	0.04774	19.4	2.14	0.03231	21.8	2.42	.02576	9.3	2.63	130
135	0.04290	20.5	2.09	0.02863	23.0	2.36	.02264	9.8	2.57	135
140	0.03866	21.6	2.04	0.02544	24.3	2.30	.01995	10.3	2.51	140
145	0.03492	22.7	1.99	0.02267	25.5	2.25	.01764	10.9	2.45	145
150	0.03162	23.8	1.95	0.02025	26.8	2.20	.01564	11.4	2.39	150

# Resistance

## Temperature Characteristics



T (°C)	Material code B (K)									T (°C)
	KA 3625			MA 3960			NA 4100			
	R (T) / R25	TF (%)	α (%/°C)	R (T) / R25	TF (%)	α (%/°C)	R (T) / R25	TF (%)	α (%/°C)	
-55	61.21	7.1	6.77	104.2	3.9	7.89	109.5	8.0	7.83	-55
-50	44.24	6.1	6.53	71.63	3.4	7.57	75.42	6.9	7.54	-50
-45	32.33	5.3	6.30	49.94	2.9	7.28	52.63	6.0	7.27	-45
-40	23.88	4.5	6.08	35.28	2.5	7.00	37.18	5.1	7.01	-40
-35	17.81	3.8	5.88	25.25	2.1	6.73	26.58	4.3	6.76	-35
-30	13.41	3.2	5.68	18.28	1.8	6.48	19.22	3.7	6.52	-30
-25	10.19	2.7	5.49	13.39	1.5	6.25	14.04	3.1	6.30	-25
-20	7.814	2.2	5.31	9.917	1.2	6.02	10.37	2.5	6.09	-20
-15	6.040	1.8	5.14	7.419	1.0	5.81	7.730	2.1	5.89	-15
-10	4.707	1.5	4.98	5.605	.8	5.61	5.817	1.6	5.70	-10
-5	3.696	1.1	4.83	4.275	.6	5.42	4.416	1.3	5.51	-5
0	2.923	.9	4.68	3.289	.5	5.24	3.382	1.0	5.34	0
5	2.329	.6	4.53	2.552	.3	5.06	2.611	.7	5.17	5
10	1.867	.4	4.40	1.997	.2	4.90	2.032	.5	5.01	10
15	1.507	.3	4.27	1.574	.1	4.74	1.593	.3	4.86	15
20	1.224	.1	4.14	1.250	.1	4.59	1.258	.1	4.71	20
25	1.0000	0.0	4.02	1.0000	0.0	4.45	1.0000	0.0	4.57	25
30	.8217	.1	3.91	.8053	.1	4.31	.8004	.1	4.44	30
35	.6788	.2	3.80	.6527	.1	4.18	.6446	.3	4.31	35
40	.5638	.4	3.69	.5323	.2	4.06	.5224	.4	4.19	40
45	.4707	.5	3.59	.4367	.3	3.94	.4258	.6	4.07	45
50	.3948	.7	3.49	.3604	.4	3.82	.3491	.8	3.96	50
55	.3328	.9	3.40	.2990	.5	3.71	.2877	1.0	3.85	55
60	.2818	1.0	3.31	.2493	.6	3.61	.2383	1.2	3.74	60
65	.2396	1.2	3.22	.2090	.7	3.51	.1984	1.4	3.64	65
70	.2046	1.4	3.14	.1760	.8	3.41	.1660	1.6	3.55	70
75	.1754	1.6	3.06	.1489	.9	3.32	.1396	1.8	3.45	75
80	.1510	1.8	2.98	.1266	1.0	3.23	.1178	2.1	3.36	80
85	.1305	2.0	2.90	.1081	1.1	3.14	.09991	2.3	3.28	85
90	.1131	2.3	2.83	.09262	1.2	3.06	.08507	2.5	3.20	90
95	.09846	2.5	2.76	.07970	1.3	2.98	.07273	2.8	3.12	95
100	.08597	2.7	2.69	.06885	1.5	2.91	.06241	3.0	3.04	100
105	.07531	2.9	2.63	.05969	1.6	2.83	.05376	3.3	2.96	105
110	.06618	3.1	2.56	.05194	1.7	2.76	.04648	3.5	2.89	110
115	.05834	3.4	2.50	.04535	1.8	2.69	.04032	3.8	2.82	115
120	.05158	3.6	2.44	.03973	2.0	2.63	.03510	4.1	2.76	120
125	.04573	3.8	2.39	.03491	2.1	2.56	.03065	4.3	2.69	125
130	.04066	4.0	2.33	.03077	2.2	2.50	.02685	4.6	2.63	130
135	.03625	4.3	2.28	.02721	2.3	2.44	.02359	4.8	2.57	135
140	.03240	4.5	2.23	.02412	2.5	2.39	.02079	5.1	2.51	140
145	.02903	4.7	2.18	.02145	2.6	2.33	.01838	5.4	2.45	145
150	.02608	5.0	2.13	.01912	2.7	2.28	.01629	5.6	2.40	150

T (°C)	Material code B (K)									T (°C)
	PA 4235			QA 4250			RA 4380			
	R (T) / R25	TF (%)	α (%/°C)	R (T) / R25	TF (%)	α (%/°C)	R (T) / R25	TF (%)	α (%/°C)	
-55	123.3	8.3	8.00	101.8	8.3	7.36	110.7	8.6	7.53	-55
-50	84.31	7.2	7.71	71.33	7.2	7.13	77.22	7.4	7.29	-50
-45	58.37	6.2	7.43	50.51	6.2	6.91	54.43	6.4	7.07	-45
-40	40.92	5.3	7.17	36.14	5.3	6.70	38.76	5.5	6.85	-40
-35	29.03	4.5	6.92	26.11	4.5	6.50	27.86	4.6	6.65	-35
-30	20.83	3.8	6.69	19.05	3.8	6.31	20.22	3.9	6.46	-30
-25	15.10	3.2	6.46	14.02	3.2	6.12	14.81	3.3	6.27	-25
-20	11.07	2.6	6.25	10.41	2.6	5.85	10.94	2.7	6.09	-20
-15	8.189	2.1	6.05	7.791	2.1	5.78	8.143	2.2	5.92	-15
-10	6.117	1.7	5.85	5.879	1.7	5.62	6.112	1.8	5.76	-10
-5	4.610	1.3	5.67	4.470	1.3	5.46	4.622	1.4	5.60	-5
0	3.504	1.0	5.49	3.424	1.0	5.31	3.522	1.0	5.45	0
5	2.686	.7	5.32	2.642	.7	5.17	2.702	.8	5.31	5
10	2.075	.5	5.16	2.052	.5	5.03	2.087	.5	5.17	10
15	1.615	.3	5.01	1.605	.3	4.90	1.623	.3	5.03	15
20	1.266	.1	4.86	1.263	.1	4.77	1.270	.1	4.91	20
25	1.0000	0.0	4.72	1.0000	0.0	4.65	1.0000	0.0	4.78	25
30	.7949	.1	4.58	.7965	.1	4.53	.7920	.1	4.66	30
35	.6359	.3	4.45	.6380	.3	4.42	.6308	.3	4.55	35
40	.5119	.4	4.32	.5139	.4	4.31	.5052	.5	4.43	40
45	.4145	.6	4.20	.4162	.6	4.20	.4068	.6	4.33	45
50	.3376	.8	4.09	.3388	.8	4.10	.3292	.8	4.22	50
55	.2765	1.0	3.98	.2771	1.0	4.00	.2678	1.0	4.12	55
60	.2276	1.2	3.87	.2278	1.2	3.90	.2189	1.3	4.02	60
65	.1883	1.4	3.77	.1881	1.4	3.81	.1797	1.5	3.93	65
70	.1566	1.7	3.67	.1560	1.7	3.72	.1483	1.7	3.84	70
75	.1308	1.9	3.58	.1300	1.9	3.63	.1228	2.0	3.75	75
80	.1098	2.1	3.48	.1088	2.1	3.55	.1022	2.2	3.67	80
85	.09258	2.4	3.40	.0914	2.4	3.47	.08537	2.5	3.58	85
90	.07838	2.6	3.31	.07708	2.6	3.39	.07160	2.7	3.50	90
95	.06662	2.9	3.23	.06527	2.9	3.31	.06029	3.0	3.42	95
100	.05686	3.1	3.15	.05547	3.2	3.24	.05095	3.2	3.35	100
105	.04871	3.4	3.07	.04731	3.4	3.17	.04322	3.5	3.28	105
110	.04189	3.7	3.00	.04049	3.7	3.10	.03679	3.8	3.21	110
115	.03614	3.9	2.93	.03478	3.9	3.03	.03143	4.1	3.14	115
120	.03130	4.2	2.86	.02996	4.2	2.96	.02693	4.3	3.07	120
125	.02719	4.5	2.79	.02590	4.5	2.90	.02316	4.6	3.01	125
130	.02370	4.7	2.73	.02246	4.7	2.84	.01997	4.9	2.94	130
135	.02072	5.0	2.67	.01953	5.0	2.78	.01728	5.2	2.88	135
140	.01817	5.3	2.61	.01704	5.3	2.72	.01499	5.4	2.82	140
145	.01598	5.5	2.55	.01490	5.5	2.67	.01305	5.7	2.77	145
150	.01410	5.8	2.49	.01307	5.8	2.61	.01138	6.0	2.71	150

## Ordering Code

### HOW TO ORDER

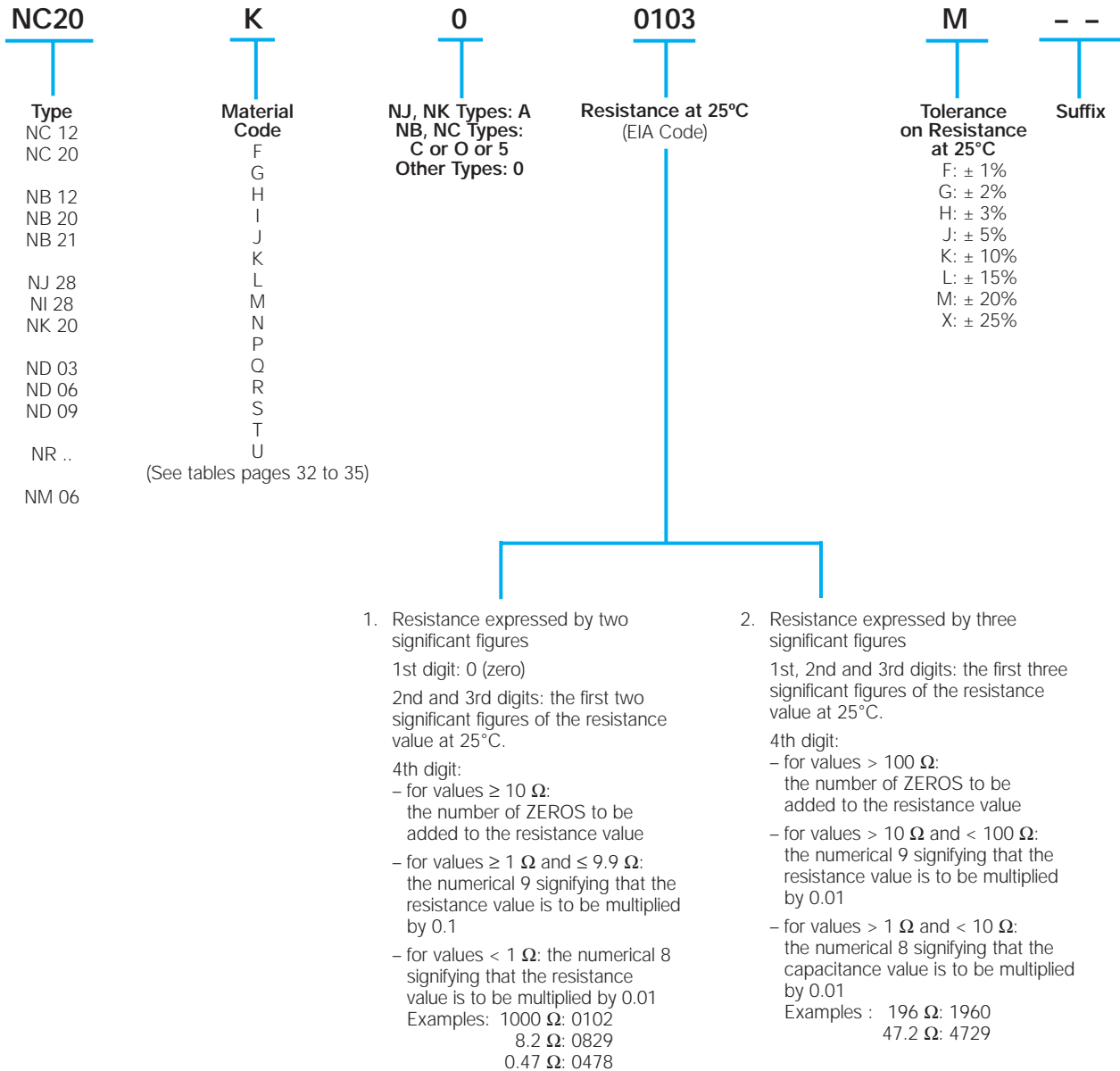

For leadless discs (types NR) see specification and ordering code on pages 22 and 23.



## IDENTIFICATION - TRACEABILITY

On the packaging of all shipped thermistors, you will find a bar code label.

This label gives systematic information on the type of product, part number, lot number, manufacturing date and quantity.

An example is given below:

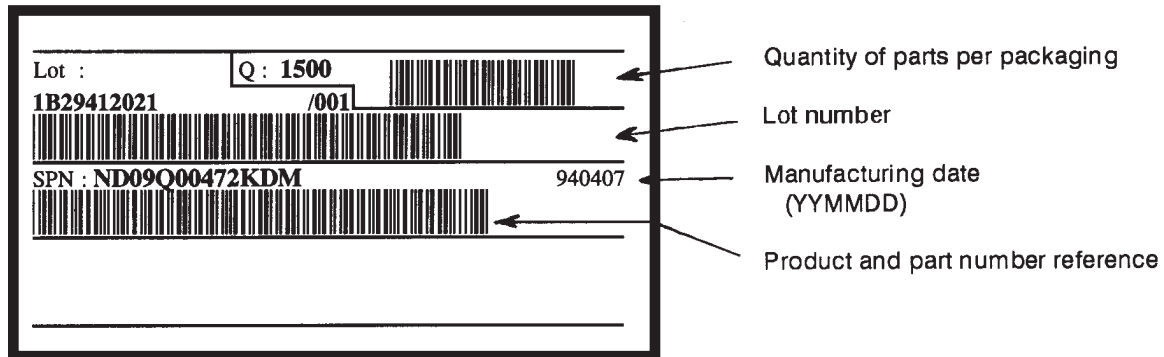

This information allows complete traceability of the entire manufacturing process, from raw materials to final inspection.

This is extremely useful for any information request, customer complaint or product return.

## BULK PACKAGING

Type	Qty / Box	Type	Qty / Box
NC 12/20	1000	ND 03	3000
NB 12/20/21	1000		
NJ 28	2000	ND 06	1500
NK 20	5000	ND 09	1500
NM 06		NF 08	450
NV 21		NF 10	450
NV 03		NF 13	400
NV 06	according	NF 15	250
NV 09	to	NF 20	150
NR	P/N		

Type	Qty / Box
PE 04	1000
PE 06	1000
PE 08	1000
PE 10	800
PE 12	500
PE 16	400
PE 20	250



### AUTOMATIC INSERTION

#### Super 8 plastic tape packaging

The mechanical and dimensional reel characteristics are in accordance with the IEC publication 286-3.

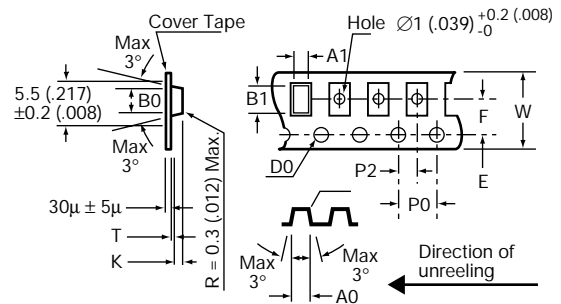

Designation	Symbol	Value	Tolerance
Tape width	W	8	±0.2
Tape thickness	T	0.4 max.	
Pitch of the sprocket holes	P0	4	±0.1
Diameter of the sprocket holes	D0	1.5 -0	±0.1
Distance	E	1.75	±0.1
Distance (center to center)	F	3.5	±0.05
Distance (center to center)	P2	2	±0.1
Sizes of the NC 12 (0805)	A0	1.5	±0.1
	B0	2.4	±0.1
	K	1.4 max.	K ±0.1 (size is adjustable) (K = t1 +0.2)
NC 20 (1206)	A0	1.95	±0.1
	B0	3.55	±0.1
	K	1.5 max.	K ±0.1 (size is adjustable) (K = t1 +0.2)

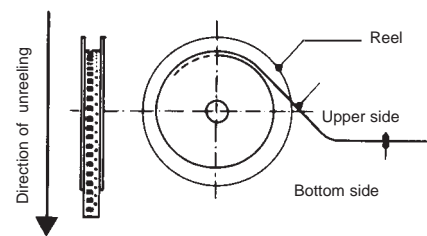
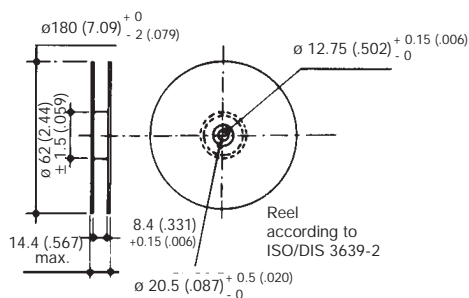

### QUANTITY PER REEL

Type	Suffix	Qty Per Reel
NC - NB 12	BA	4000
NB 21	BE	2000
NC 20 - NB 20	BA	3000
	BE	1500

## NTC/PTC Disc Thermistors

### PACKAGING AND KINK SUFFIXES

Tables below indicate the suffixes to specify when ordering to get the required kink and packaging. For devices on tape, it is necessary to specify the height (H or Ho) which is the distance between the tape axis (sprocket holes axis) and the seating plane on the printed circuit board. The following types can be ordered on tape either in AMMOPACK (fan folder) or on REEL in accordance with IEC 286-2.

#### - Straight leads:

**H** represents the distance between the sprocket holes axis and the bottom plane of component body (base of resin or base of stand off).

#### - Kinked leads and flat leads:

**Ho** represents the distance between the sprocket holes axis and the base on the knee (kinked leads) or the bottom of the flat part (flat leads).

#### NTC

##### Type ND 03

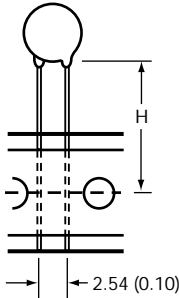

millimeters (inches)

Suffix	H	Leads	Packaging
CA	16 ± 0.5 (0.630 ± 0.020)	Straight	AMMOPACK
CB	16 ± 0.5 (0.630 ± 0.020)	Straight	REEL
CC	19.5 ± 0.5 (0.768 ± 0.020)	Straight	AMMOPACK
CD	19.5 ± 0.5 (0.768 ± 0.020)	Straight	REEL

#### NTC

##### Types NS ND NV 06/09

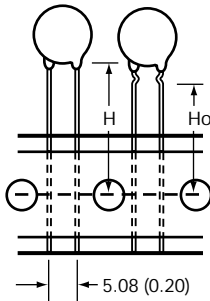

millimeters (inches)

Suffix	H or Ho	Leads	Packaging
DA	16 ± 0.5 (0.630 ± 0.020)	Straight	AMMOPACK
DB	16 ± 0.5 (0.630 ± 0.020)	Straight	REEL
DC	19.5 ± 0.5 (0.768 ± 0.020)	Straight	AMMOPACK
DD	19.5 ± 0.5 (0.768 ± 0.020)	Straight	REEL
DL	16 ± 0.5 (0.630 ± 0.020)	Kinked	AMMOPACK
DM	16 ± 0.5 (0.630 ± 0.020)	Kinked	REEL
DN	19.5 ± 0.5 (0.768 ± 0.020)	Kinked	AMMOPACK
DP	19.5 ± 0.5 (0.768 ± 0.020)	Kinked	REEL

#### PTC

##### Types PE 04 PE 06 PE 08 PE 10

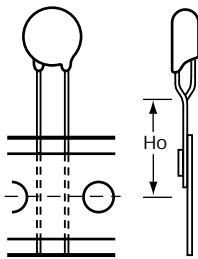

millimeters (inches)

Suffix	Ho	Leads	Packaging
D5	16 ± 0.5 (0.630 ± 0.020)	Kinked	REEL
D6	19.5 ± 0.5 (0.768 ± 0.020)	Kinked	REEL
D7	16 ± 0.5 (0.630 ± 0.020)	Kinked	AMMOPACK
D8	19.5 ± 0.5 (0.768 ± 0.020)	Kinked	AMMOPACK

### PACKAGING QUANTITIES

Product	Quantity Per Size		
	Type	AMMOPACK	REEL
NTC	ND 03	3000	3000
	ND - NV 06	1500	1500
	ND - NV 09	1500	1500
PTC	PE 04 - 06 - 08 - 10	1500	1500

# Packaging for Automatic Insertion



## NTC Disc Thermistors / NF Series

### PACKAGING AND KINK SUFFIXES

The following types can be ordered on tape either in AMMOPACK (fan folder) or on REEL in accordance with IEC 286-2.

Types	Straight		NF08 Internal Kink		"Y" Kink	
Leads	Straight		Internal Kink		"Y" Kink	
DIMENSIONS: millimeters (inches)						
	Packaging	AMMOPACK	REEL	AMMOPACK	REEL	AMMOPACK
Ho = 16	DA	DB	DQ	DR	D7	D5
Ho = 19.5	DC	DD	DS	DT	D8	D6

Types	Straight		NF08 / 10 / 13 Internal Kink		"Y" Kink	
Leads	Straight		Internal Kink		"Y" Kink	
DIMENSIONS: millimeters (inches)						
	Packaging	AMMOPACK	REEL	AMMOPACK	REEL	AMMOPACK
Ho = 16	EA	EN	EC	EF	EQ	ER
Ho = 19.5	EB	ED				

### PACKAGING QUANTITIES

Type	AMMOPACK	REEL
NF08* (5.08)	1000	1000
NF08 (7.62)	750	750
NF10* (5.08)	-	-
NF10 (7.62)	750	750
NF13 (7.62)	750	750
NF15 (7.62)	-	-
NF20 (7.62)	-	-

# Automatic Insertion



## NTC/PTC Disc Thermistors

### TAPING CHARACTERISTICS

#### Missing components

A maximum of 3 consecutive components may be missing from the bandolier, surrounded by at least 6 filled positions. The number of missing components may not exceed 0.5% of the total per packing module.

The beginning and the end of tape exhibit 8 or 9 blank positions.

DIMENSIONS: millimeters (inches)

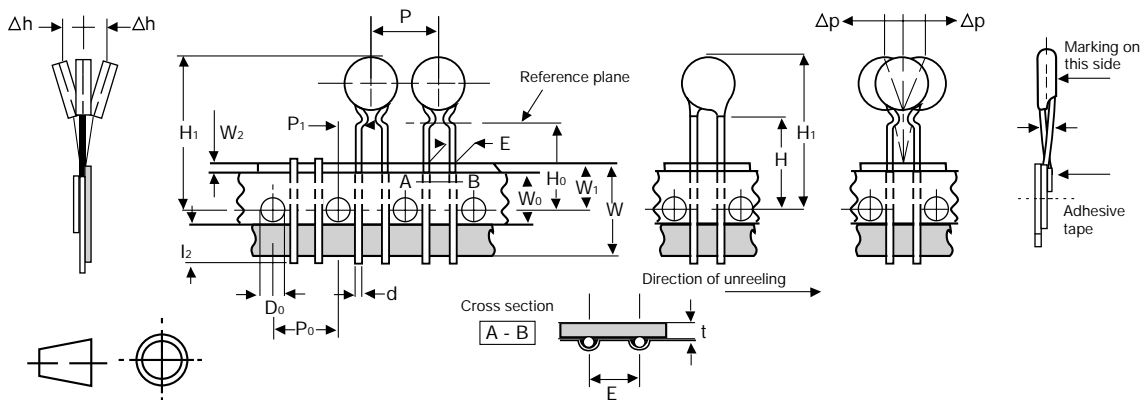
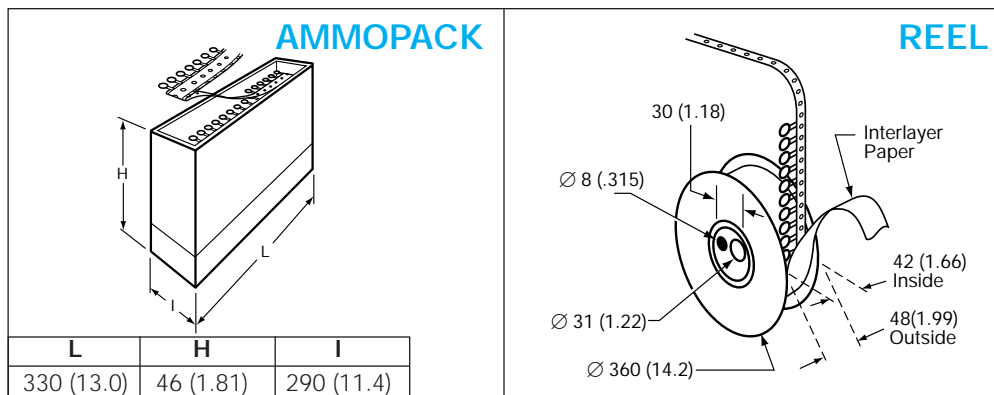

Value	Tolerance	Dimensions Characteristics	
18	+1 / -0.5	W	Leading tape width
6	±0.3	W <sub>0</sub>	Adhesive tape width
9	+0.75 / -0.5	W <sub>1</sub>	Sprocket hole position
3 max.		W <sub>2</sub>	Distance between the top of the tape and the adhesive
4	±0.2	D <sub>0</sub>	Diameter of sprocket hole
16/19.5	±0.5	H <sub>0</sub>	Distance between the tape axis and the seating plane of the component
		H <sub>1</sub>	Distance between the tape axis and the top of component body

Value	Tolerance	Dimensions Characteristics		
12.7	±0.2	P <sub>0</sub>	Sprocket holes pitch	
254	±1	-	Distance between 21 consecutive holes 20 pitches	
0.7	±0.2	t	Total thickness of tape	
2.54	5.08	+0.6 -0.1	F	Lead spacing
5.08	3.85	± 0.7	P <sub>1</sub>	Distance between the sprocket hole axis and the lead axis
12.7	±1.0	P	Spacing of components	
0.5	0.6	±5%	d	Lead diameter
0	±1.3	<sup>3</sup> P	Verticality of components	
0	±2	<sup>3</sup> h	Alignment of components	