



T-1 3/4 (5mm) SOLID STATE LAMPS

LTL-4203	RED	LTL-4233/307G	GREEN
LTL-4213/307P	BRIGHT RED	LTL-4253/307Y	YELLOW
LTL-4223/307E	HIGH EFFICIENCY RED	LTL-4294/307EA	ORANGE

LED LAMPS

FEATURES

- LOW POWER CONSUMPTION.
- HIGH EFFICIENCY.
- VERSATILE MOUNTING ON P.C. BOARD OR PANEL.
- I.C. COMPATIBLE/LOW CURRENT REQUIREMENTS.
- POPULAR T-1 3/4 DIAMETER, 1" LEAD LENGTH.
- RELIABLE AND RUGGED.
- LOW COST.

DESCRIPTION

The Red source color devices are made with Gallium Arsenide Phosphide on Gallium Arsenide Red Light Emitting Diode.

The Bright Red source color devices are made with Gallium Phosphide on Gallium Phosphide Red Light Emitting Diode.

The High Efficiency Red and Orange source color devices are made with Gallium Arsenide Phosphide on Gallium Phosphide Orange Light Emitting Diode.

The Green source color devices are made with Gallium Phosphide on Gallium Phosphide Green Light Emitting Diode.

The Yellow source color devices are made with Gallium Arsenide Phosphide on Gallium Phosphide Yellow Light Emitting Diode.

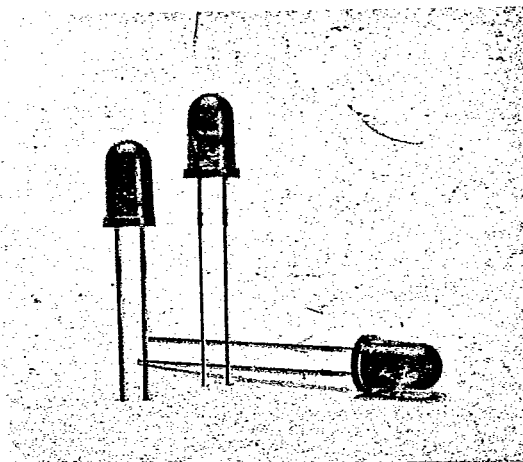

PACKAGE DIMENSIONS

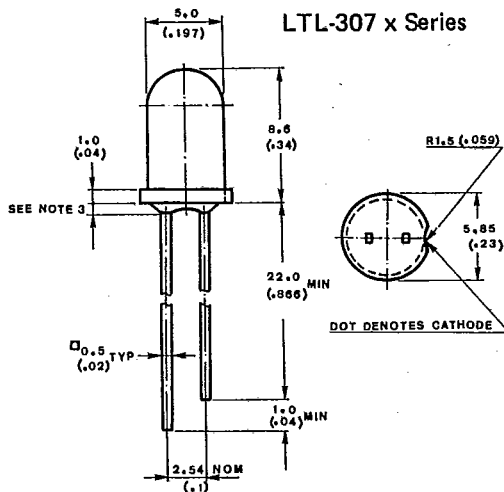
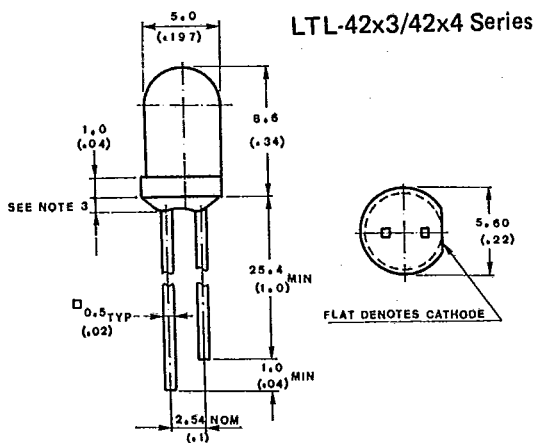

NOTES:

1. All dimensions are in millimeters (inches).
2. Tolerance is $\pm 0.25\text{mm}$ (.010") unless otherwise noted.
3. Protruded resin under flange is 1.5mm (.059") max.
4. Lead spacing is measured where the leads emerge from the package.
5. Specifications are subject to change without notice.

2-108

183

DEVICES

PART NO. LTL--	LENS		SOURCE COLOR
	COLOR	DIFFUSION	
4203 4204 4208	Red Red Water Clear	Diffused Transparent Non-Diffused	Red
4213 4214	Red	Diffused Transparent	Bright Red
4223 4224	Red	Diffused Transparent	Hi. Eff. Red
4233 4234	Green	Diffused Transparent	Green
4253 4254	Yellow	Diffused Transparent	Yellow
4293 4294	Orange	Diffused Transparent	Orange

PART NO. LTL--	LENS		SOURCE COLOR
	COLOR	DIFFUSION	
307P 307PE	Red	Diffused Transparent	Bright Red
307E 307EE	Red	Diffused Transparent	Hi. Eff. Red
307G 307GE	Green	Diffused Transparent	Green
307Y	Yellow	Diffused	Yellow
307EA	Orange	Diffused	Orange

ABSOLUTE MAXIMUM RATINGS AT Ta = 25°C

PARAMETER	RED	BRIGHT RED	GREEN	YELLOW	HI. EFF. RED ORANGE	UNIT
Power Dissipation	80	40	100	60	100	mW
Peak Forward Current (1/10 Duty Cycle, 0.1ms Pulse Width)	200	60	120	80	120	mA
Continuous Forward Current	40	15	30	20	30	mA
Derating Linear From 25°C	0.5	0.2	0.4	0.25	0.4	mA/°C
Reverse Voltage	5	5	5	5	5	V
Operating Temperature Range	-55°C to +100°C					
Storage Temperature Range	-55°C to +100°C					
Lead Soldering Temperature [1.6mm (0.063in) From Body]	260°C for 5 Seconds					

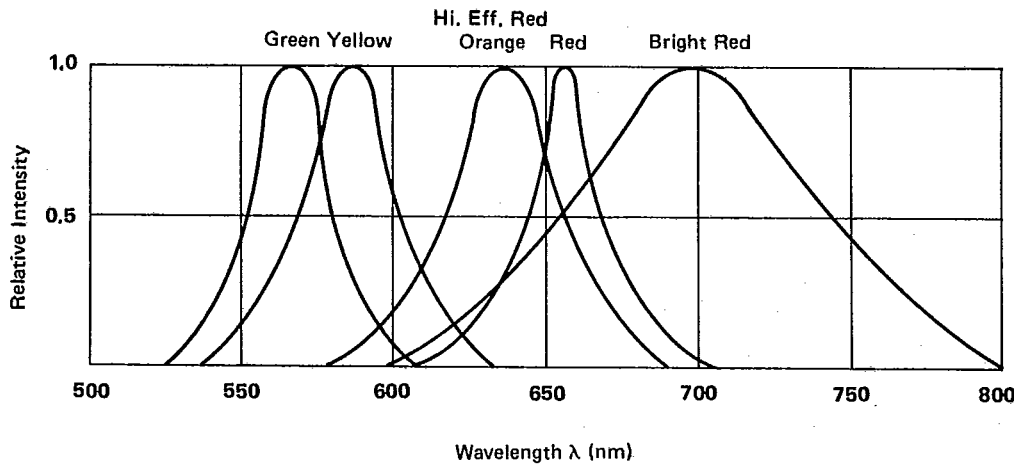

FIG. 1 RELATIVE INTENSITY VS. WAVELENGTH

ELECTRICAL/OPTICAL CHARACTERISTICS AND CURVES AT TA = 25°C

PARAMETER	SYMBOL	PART NO. LTL--	MIN.	TYP.	MAX.	UNIT	TEST CONDITION
Luminous Intensity	Iv	4203 4204 4208	0.8 1.7 1.7	0.8 6.5 5.5		mcd	IF = 10 mA Note 1
Viewing Angle	2θ½	4203 4204 4208		36 16 16		deg.	Note 2 (Fig. 6)
Peak Emission Wavelength	λPEAK			655		nm	Measurement @ Peak (Fig. 1)
Spectral Line Half Width	Δλ			24		nm	
Forward Voltage	VF			1.7	2.0	V	IF = 20 mA
Reverse Current	IR				100	μA	VR = 5V
Capacitance	C			30		PF	VF = 0 f = 1 MHz

LED LAMPS

NOTES: 1. Luminous intensity is measured with a light sensor and filter combination that approximates the CIE (Commission Internationale De L'Eclairage) eye-response curve.
2. θ½ is the off-axis angle at which the luminous intensity is half the axial luminous intensity.

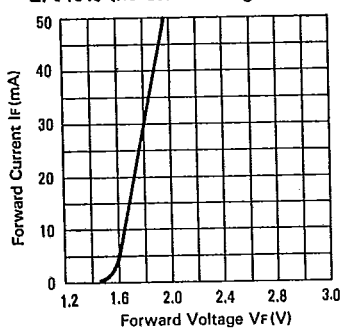

FIG. 2 FORWARD CURRENT VS. FORWARD VOLTAGE.

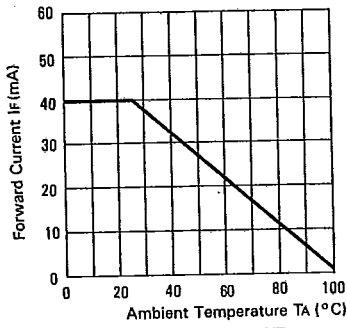

FIG. 3 FORWARD CURRENT DERATING CURVE.

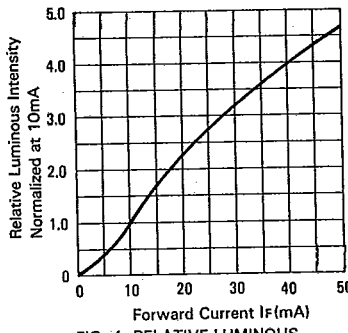

FIG. 4 RELATIVE LUMINOUS INTENSITY VS. FORWARD CURRENT.

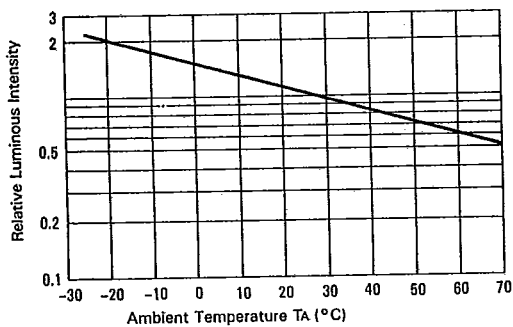

FIG. 5 LUMINOUS INTENSITY VS. AMBIENT TEMPERATURE

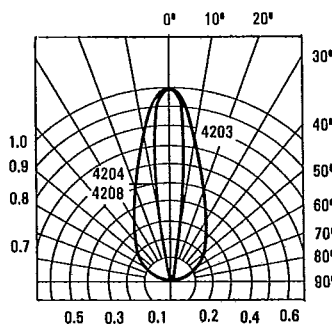

FIG. 6 SPATIAL DISTRIBUTION

ELECTRICAL/OPTICAL CHARACTERISTICS AND CURVES AT Ta = 25°C

PARAMETER	SYMBOL	PART NO. LTL-	MIN.	TYP.	MAX.	UNIT	TEST CONDITION
Luminous Intensity	Iv	4213 4214 4223 4224	1.1 2.5 2.5 10.0	3.8 8.7 8.7 40.0		mcđ	If = 10mA Note 1
Viewing Angle	2θ½	4213 4214 4223 4224		36 18 36 18		deg.	Note 2 (Fig. 11)
Peak Emission Wavelength	λPEAK	4213 4214 4223 4224		667 687 635 635		nm	Measurement @ Peak (Fig. 1)
Spectral Line Half Width	Δλ	4213 4214 4223 4224		90 90 40 40		nm	
Forward Voltage	Vf	4213 4214 4223 4224		2.1 2.1 2.0 2.0	2.8	V	If = 20mA
Reverse Current	Ir	4213 4214 4223 4224			100	μA	Vr = 5 V
Capacitance	C	4213 4214 4223 4224		55 55 20 20		PF	Vf = 0 f = 1MHZ

NOTES: 1. Luminous intensity is measured with a light sensor and filter combination that approximates the CIE (Commission Internationale De L'Eclairage) eye-response curve.
 2. θ½ is the off-axis angle at which the luminous intensity is half the axial luminous intensity.

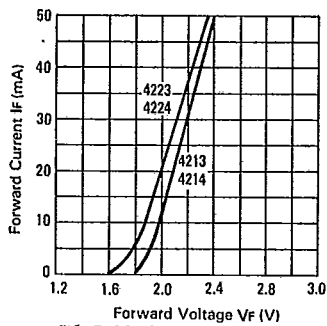

FIG. 7 FORWARD CURRENT (VS) FORWARD VOLTAGE

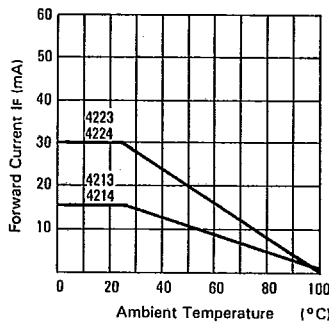

FIG. 8 FORWARD CURRENT DERATING CURVE

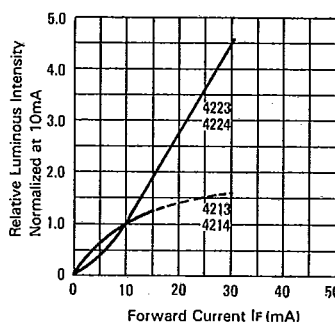

FIG. 9 RELATIVE LUMINOUS INTENSITY VS. FORWARD CURRENT

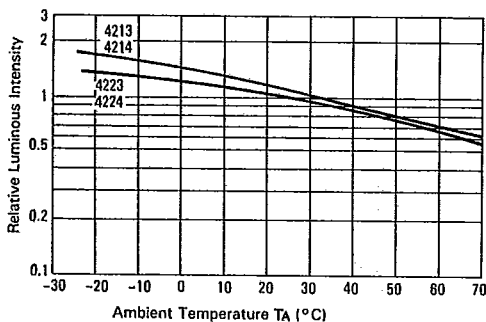

FIG. 10 LUMINOUS INTENSITY VS. AMBIENT TEMPERATURE

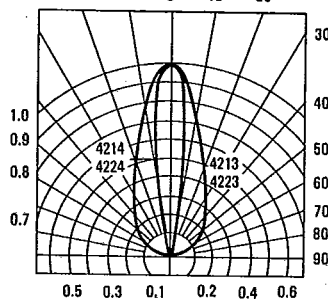

FIG. 11 SPATIAL DISTRIBUTION

ELECTRICAL/OPTICAL CHARACTERISTICS AND CURVES AT TA = 25°C

PARAMETER	SYMBOL	PART NO. LTL-	MIN.	TYP.	MAX.	UNIT	TEST CONDITION
Luminous Intensity	Iv	4233 4234 4253 4254	2.5 10.0 2.5 10.0	8.7 40.0 8.7 40.0		mcd	If = 10mA Note 1
Viewing Angle	2θ½	4233 4234 4253 4254		36 16 36 16		deg.	Note 2 (Fig. 16)
Peak Emission Wavelength	λPEAK	4233 4234 4253 4254		585 585 585 585		nm	Measurement @ Peak (Fig. 1)
Spectral Line Half Width	Δλ	4233 4234 4253 4254		30 30 35 35		nm	
Forward Voltage	Vf	4233 4234 4253 4254		2.1	2.8	V	If = 20mA
Reverse Current	Ir	4233 4234 4253 4254			100	μA	Vr = 5 V
Capacitance	C	4233 4234 4253 4254		35 35 15 15		PF	Vf = 0 f = 1MHZ

LED LAMPS

NOTES: 1. Luminous Intensity is measured with a light sensor and filter combination that approximates the CIE (Commission Internationale De L'Eclairage) eye-response curve.
2. θ½ is the off-axis angle at which the luminous intensity is half the axial luminous intensity.

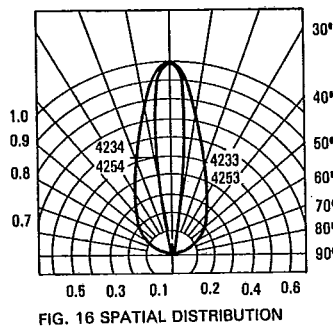
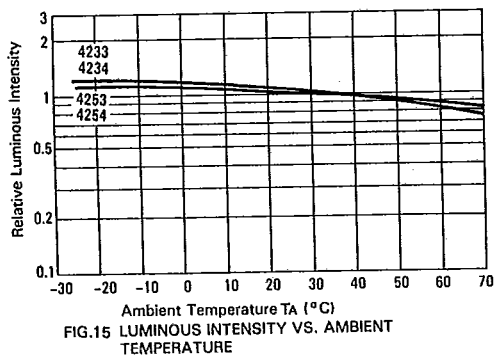
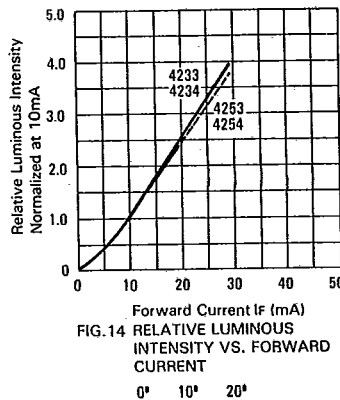
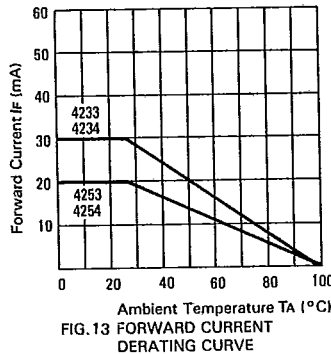
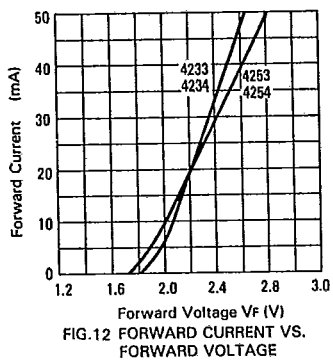

ELECTRICAL/OPTICAL CHARACTERISTICS AND CURVES AT TA = 25°C

PARAMETER	SYMBOL	PART NO. LTL	MIN.	TYP.	MAX.	UNIT	TEST CONDITION
Luminous Intensity	IV	4293 4294	2.5 10.0	8.7 40.0		mcd	IF = 10 mA Note 1
Viewing Angle	2θ½	4293 4294		36 16		deg.	Note 2 (Fig. 21)
Peak Emission Wavelength	λPEAK			635		nm	Measurement @ Peak (Fig. 1)
Spectral Line Half Width	Δλ			40		nm	
Forward Voltage	VF			2.0	2.8	V	IF = 20 mA
Reverse Current	IR				100	μA	VR = 5V
Capacitance	C			20		PF	VF = 0 f = 1 MHz

NOTES: 1. Luminous Intensity is measured with a light sensor and filter combination that approximates the CIE (Commission Internationale De L'Eclairage) eye-response curve.
 2. θ½ is the off-axis angle at which the luminous intensity is half the axial luminous intensity.

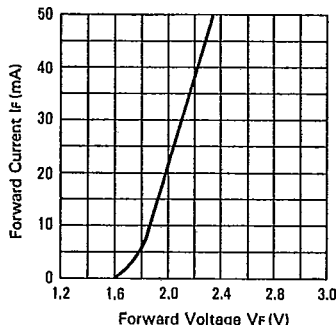

FIG. 17 FORWARD CURRENT VS. FORWARD VOLTAGE

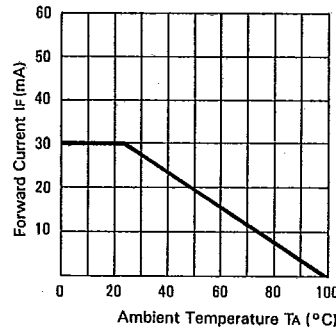

FIG. 18 FORWARD CURRENT DERATING CURVE

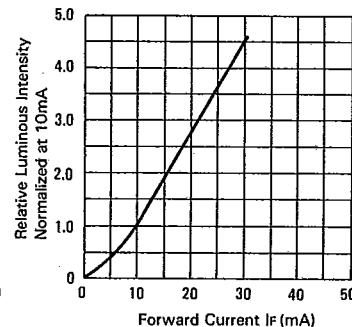

FIG. 19 RELATIVE LUMINOUS INTENSITY VS. FORWARD CURRENT

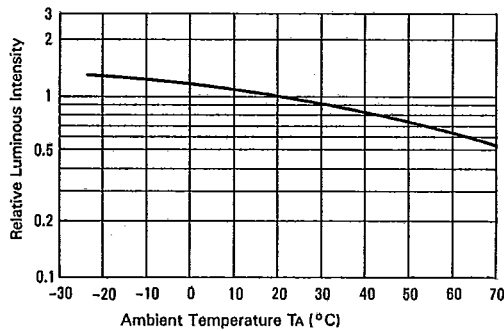

FIG. 20 LUMINOUS INTENSITY VS. AMBIENT TEMPERATURE

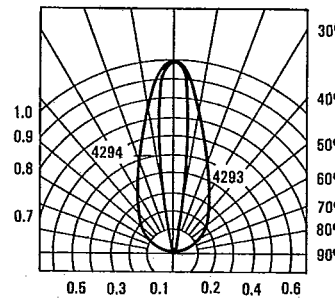

FIG. 21 SPATIAL DISTRIBUTION

ELECTRICAL/OPTICAL CHARACTERISTICS AND CURVES AT TA = 25°C

PARAMETER	SYMBOL	PART NO. LTL-	MIN.	TYP.	MAX.	UNIT	TEST CONDITION
Luminous Intensity	Iv	307P 307PE 307E 307EE	1.1 2.5 5.6 9.0	5.6 9.0 19.0 30.3		mcd	IF = 10mA Note 1
Viewing Angle	2θ½	307P 307PE 307E 307EE		50 40 50 40		deg.	Note 2 (Fig. 26)
Peak Emission Wavelength	λPEAK	307P 307PE 307E 307EE		697 697 635 635		nm	Measurement @ Peak (Fig. 1)
Spectral Line Half Width	Δλ	307P 307PE 307E 307EE		90 90 40 40		nm	
Forward Voltage	VF	307P 307PE 307E 307EE		2.1 2.1 2.0 2.0	2.8	V	IF = 20mA
Reverse Current	IR	307P 307PE 307E 307EE			100	μA	VR = 5 V
Capacitance	C	307P 307PE 307E 307EE		55 55 20 20		PF	VF = 0 f = 1MHZ

LED LAMPS

NOTES: 1. Luminous intensity is measured with a light sensor and filter combination that approximates the CIE (Commission Internationale De L'Eclairage) eye-response curve.
 2. θ½ is the off-axis angle at which the luminous intensity is half the axial luminous intensity.

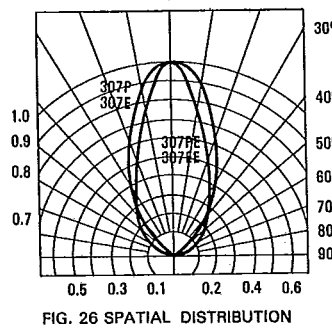
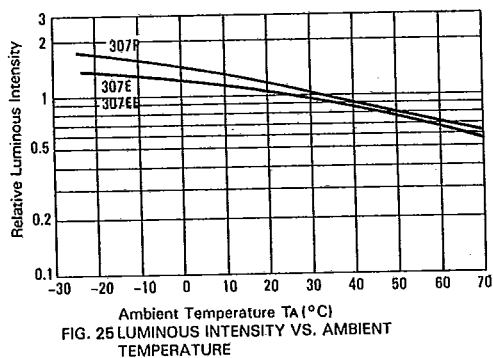
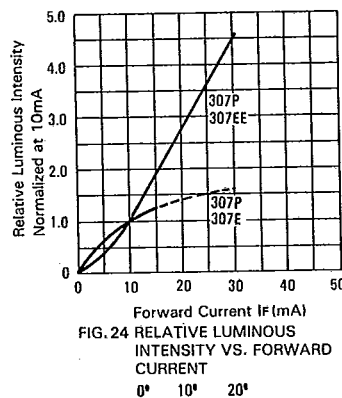
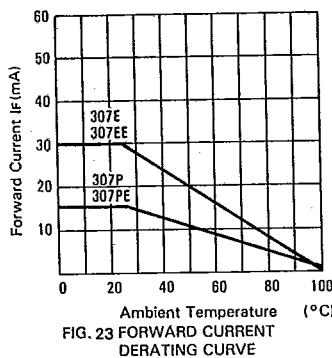
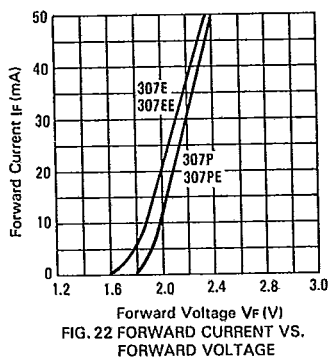

ELECTRICAL/OPTICAL CHARACTERISTICS AND CURVES AT TA = 25°C

PARAMETER	SYMBOL	PART NO. LTL-	MIN.	TYP.	MAX.	UNIT	TEST CONDITION
Luminous Intensity	Iv	307G 307GE 307Y	4.0 8.7 4.0	12.6 29.0 12.6		mcd	If = 10 mA Note 1
Viewing Angle	2θ½	307G 307GE 307Y		50 40 50		deg.	Note 2(Fig. 31)
Peak Emission Wavelength	λPEAK	307G 307GE 307Y		565 565 585		nm	Measurement @ Peak (Fig. 1)
Spectral Line Half Width	Δλ	307G 307GE 307Y		30 30 35		nm	
Forward Voltage	VF	307G 307GE 307Y		2.1	2.8	V	If = 20 mA
Reverse Current	IR	307G 307GE 307Y			100	μA	VR = 5 V
Capacitance	C	307G 307GE 307Y		35 35 15		PF	VF = 0 f = 1MHZ

NOTES: 1. Luminous Intensity is measured with a light sensor and filter combination that approximates the CIE (Commission Internationale De L'Eclairage) eye-response curve.
 2. θ½ is the off-axis angle at which the luminous intensity is half the axial luminous intensity.

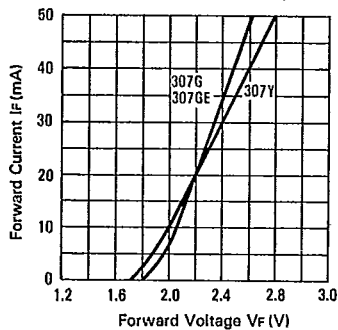

FIG. 27 FORWARD CURRENT VS. FORWARD VOLTAGE

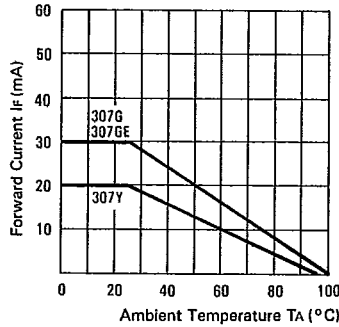

FIG. 28 FORWARD CURRENT DERATING CURVE

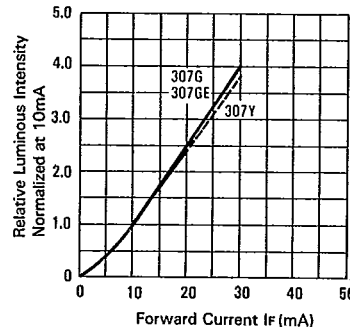

FIG. 29 RELATIVE LUMINOUS INTENSITY VS. FORWARD CURRENT

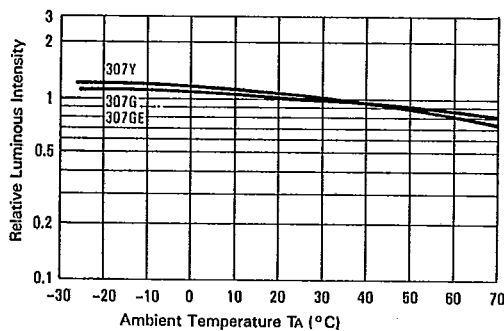

FIG. 30 LUMINOUS INTENSITY VS. AMBIENT TEMPERATURE

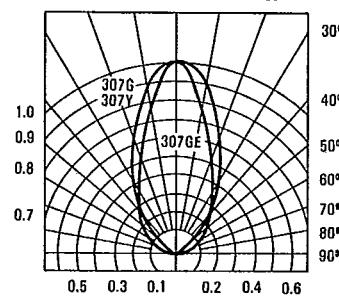

FIG. 31 SPATIAL DISTRIBUTION

ELECTRICAL/OPTICAL CHARACTERISTICS AND CURVES AT $T_A = 25^\circ C$

PARAMETER	SYMBOL	PART NO. LTL-	MIN.	TYP.	MAX.	UNIT	TEST CONDITION
Luminous Intensity	I_v	307EA	5.6	19.0		mcd	$I_F = 10 \text{ mA}$ Note 1
Viewing Angle	$2\theta_{1/2}$	307EA		50		deg.	Note 2 (Fig. 36)
Peak Emission Wavelength	λ_{PEAK}			630		nm	Measurement @ Peak (Fig. 1)
Spectral Line Half Width	$\Delta\lambda$			40		nm	
Forward Voltage	V_F			2.0	2.8	V	$I_F = 20 \text{ mA}$
Reverse Current	I_R				100	μA	$V_R = 5V$
Capacitance	C			20		PF	$V_F = 0$ $f = 1 \text{ MHz}$



NOTES: 1. Luminous intensity is measured with a light sensor and filter combination that approximates the CIE (Commission Internationale De L'Eclairage) eye-response curve.

2. $\theta_{1/2}$ is the off-axis angle at which the luminous intensity is half the axial luminous intensity.

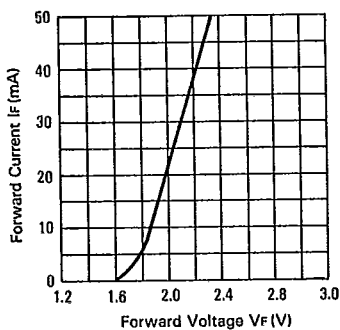

FIG. 2 FORWARD CURRENT VS. FORWARD VOLTAGE

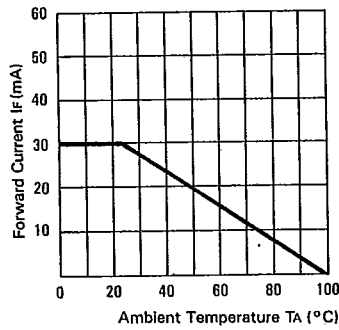

FIG. 3 FORWARD CURRENT DERATING CURVE

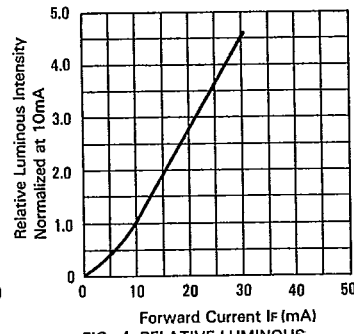

FIG. 4 RELATIVE LUMINOUS INTENSITY VS. FORWARD CURRENT

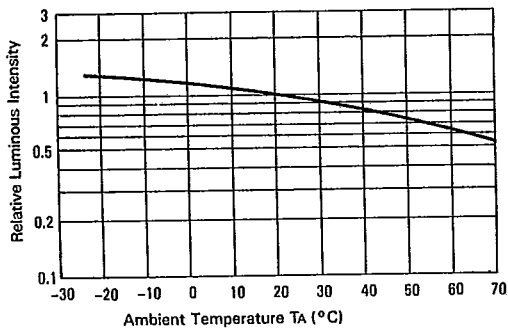

FIG. 5 LUMINOUS INTENSITY VS. AMBIENT TEMPERATURE

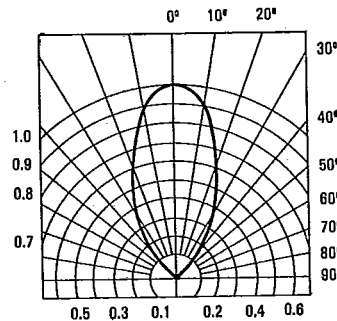

FIG. 6 SPATIAL DISTRIBUTION