

EXAMINED BY : <i>Jony Chen</i>	EMERGING DISPLAY TECHNOLOGIES CORPORATION	FILE NO . CAS-10074
APPROVED BY:		ISSUE : NOV.17,1999
<i>David Chang</i>		TOTAL PAGE : 7
		VERSION : 5

CUSTOMER ACCEPTANCE SPECIFICATIONS

MODEL NO. :

16240(LED TYPES)

FOR MESSRS :

CUSTOMER'S APPROVAL

DATE : _____

BY : _____

NUMBERING SYSTEM

Polarizer Mode	Backlight	Code value
Transflective	LED	L
Transmissive	LED	M

Backlight Color	Code Value
Yellow-Green	Y
RED	R

E	W	1	6	2	4	0	Y	L	Y
---	---	---	---	---	---	---	---	---	---

LCD type + LCD color	Code Value
STN + Yellow-Green	Y
STN + Gray	G
STN + Blue	B

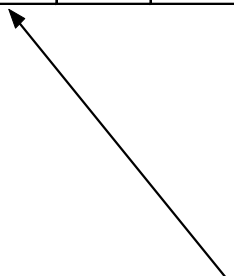
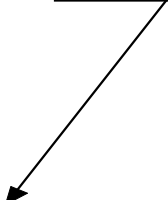
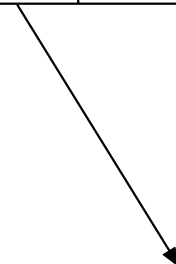

TABLE OF CONTENTS

NO.	ITEM	PAGE
=====		
1.	GENERAL SPECIFICATIONS -----	1
2.	MECHANICAL SPECIFICATIONS -----	1
3.	ABSOLUTE MAXIMUM RATINGS -----	2
4.	ELECTRICAL CHARACTERISTICS -----	3
5.	OPTICAL CHARACTERISTICS -----	3
6.	OUTLINE DIMENSION -----	4
7.	DETAIL DRAWING OF DOT MATRIX -----	5
8.	BLOCK DIAGRAM -----	5
9.	INTERFACE SIGNALS -----	6
10.	POWER SUPPLY -----	7
11.	DISPLAY DATA RAM ADDRESS -----	7

1. GENERAL SPECIFICATIONS

1.1 GENERAL SPECIFICATIONS

PLEASE REFER TO :

CUSTOMER ACCEPTANCE STANDARD SPECIFICATIONS :

EU - 002A

1.2 APPLICATION NOTES FOR CONTROLLER / DRIVER :

PLEASE REFER TO :

CUSTOMER ACCEPTANCE STANDARD SPECIFICATIONS :

EU - KS0066

1.3 THIS INDIVIDUAL SPECIFICATIONS IS PRIOR TO GENERAL SPECIFICATIONS .

2. MECHANICAL SPECIFICATIONS

- (1) NUMBER OF CHARACTER ----- 16 CH * 2 LINES
- (2) MODULE SIZE ----- 122.0W * 44.0H * 14.0D (max.) mm
- (3) EFFECTIVE AREA ----- 99.0W * 24.0H mm
- (4) CHARACTER FONT ----- 5 * 7 DOTS + CURSOR
- (5) CHARACTER SIZE ----- 4.84W * 9.66H mm
- (6) CHARACTER PITCH ----- 6.0W * 10.34H mm
- (7) DOT SIZE ----- 0.92W * 1.10H mm
- (8) DOT PITCH ----- 0.98W * 1.16H mm
- (9) LCD TYPE *
- (10) DRIVING METHOD ----- 1 / 16 DUTY MULTIPLEX DRIVE
- (11) BACK - LIGHT *

* PLEASE REFER TO NUMBERING SYSTEM

3. ABSOLUTE MAXIMUM RATINGS

3.1 ELECTRICAL ABSOLUTE MAXIMUM RATINGS . (AT Ta = 25 °C)

PARAMETER	SYMBOL	MIN .	MAX .	UNIT	REMARK
POWER SUPPLY FOR LOGIC	VDD – VSS	0	7.0	V	
POWER SUPPLY FOR LCD DRIVE	VDD – VO	0	13.0	V	
INPUT VOLTAGE	VI	VSS	VDD	V	
STATIC ELECTRICITY	—	—	100	V	NOTE (1)

NOTE (1) : TEST METHOD AND CONDITIONS :
AFTER CHARGING UP 200 PF CAPACITOR BY STATED VOLTAGE ,
THE CAPACITOR IS CONNECTED WITH INTERFACE PINS OF THE
MODULE .

3.2 ENVIRONMENTAL ABSOLUTE MAXIMUM RATINGS .

I T E M	OPERATING		STORAGE		REMARK
	MIN .	MAX .	MIN .	MAX .	
AMBIENT TEMPERATURE	- 20 °C	70 °C	- 30 °C	80 °C	NOTE (2) , (3)
HUMIDITY	—	90 % RH	—	90 % RH	WITHOUT CONDENSATION
VIBRATION	—	4.9 m/s ² (0.5 G)	—	19.6 m/s ² (2 G)	
SHOCK	—	29.4 m/s ² (3 G)	—	490.0 m/s ² (50 G)	XYZ DIRECTIONS
CORROSIVE GAS	NOT ACCEPTABLE		NOT ACCEPTABLE		

NOTE (2) : Ta AT -30°C : 48HR MAX .
80°C : 168HR MAX .

NOTE (3) : BACKGROUND COLOR CHANGES SLIGHTLY DEPENDING ON AMBIENT
TEMPERATURE THIS PHENOMENON IS REVERSIBLE .

4. ELECTRICAL CHARACTERISTICS

Ta = 25°C

VDD = 5.0V ± 0.25 V

PARAMETER	SYMBOL	CONDITION	MIN.	TYP.	MAX.	UNIT
H LEVEL INPUT VOLTAGE	VIH	—	2.2	—	—	V
L LEVEL INPUT VOLTAGE	VIL	—	—	—	0.6	V
H LEVEL OUTPUT VOLTAGE	VOH	-IOH = 0.2 mA	2.4	—	—	V
L LEVEL OUTPUT VOLTAGE	VOL	IOL = 1.2 mA	—	—	0.4	V
POWER SUPPLY CURRENT (LOGIC)	IDD	VDD = 5.0 V	—	1.0	3.0	mA
RECOMMENDED LCD DRIVING VOLTAGE	VDD - VO ∅ = 10° θ = 0° DUTY = 1/16	Ta = -20 °C	—	4.4	—	V
		Ta = 25 °C	—	4.4	—	V
		Ta = 70 °C	—	4.4	—	V
CLOCK OSCILLATION FREQUENCY	FOSC	Ta = 25 °C	—	140	—	KHZ
POWER SUPPLY CURRENT (FOR LED BACKLIGHT)	ILED	VDD = 5.0V (INCLUDE IDD)	—	190	—	mA

5. OPTICAL CHARACTERISTICS .

Ta = 25 °C

VDD = 5.0 V

ITEM	SYMBOL	CONDITION	MIN.	TYP.	MAX.	UNIT	NOTE	
VIEWING AREA	∅ 2 - ∅ 1	K ≥ 1.4	30	—	—	deg.	1	
CONTRAST RATIO	K	∅ = 10° θ = 0°	5	—	—	—	1	
RESPONSE TIME	tr (rise)	∅ = 10° θ = 0°	Ta = -20°C	—	5538	—	ms	1
			Ta = 25°C	—	228	—		
			Ta = 70°C	—	104	—		
	tf (fall)		Ta = -20°C	—	2316	—		
			Ta = 25°C	—	174	—		
			Ta = 70°C	—	85	—		
THE BRIGHTNESS OF BACK- LIGHT	L	VDD = 5.0V	—	15	—	cd/m2	1, 2	
			—	35	—		1, 3	
PEAK EMISSION WAVELENGTH	λ P	VDD = 5.0V	—	572	—	nm	1	

NOTE (1): PLEASE REFER TO :
CUSTOMER ACCEPTANCE STANDARD SPECIFICATION : EU-002A

NOTE (2): POLARIZER MODE : TRANSFLECTIVE

NOTE (3): POLARIZER MODE : TRANSMISSIVE

6. OUTLINE DIMENSION

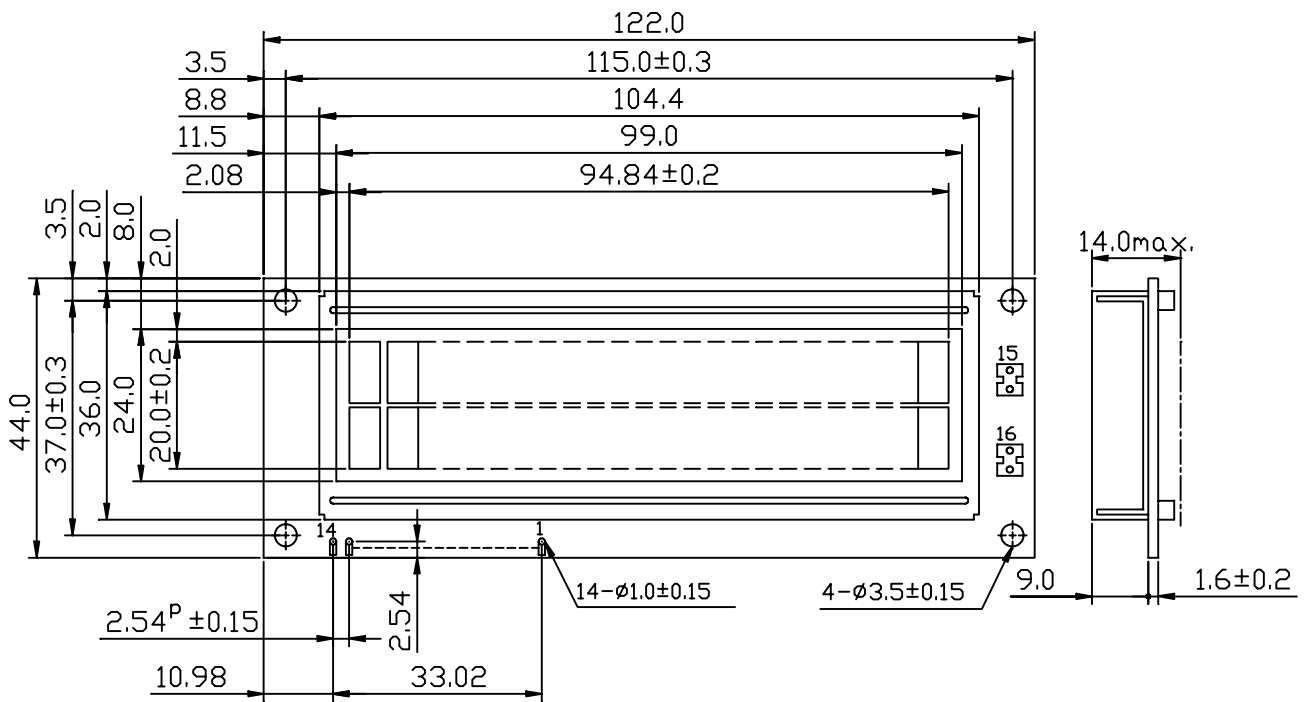

UNIT : mm
SCALE : NTS
NOT SPECIFIED TOLERANCE IS ±0.5mm

7. DETAIL DRAWING OF DOT MATRIX

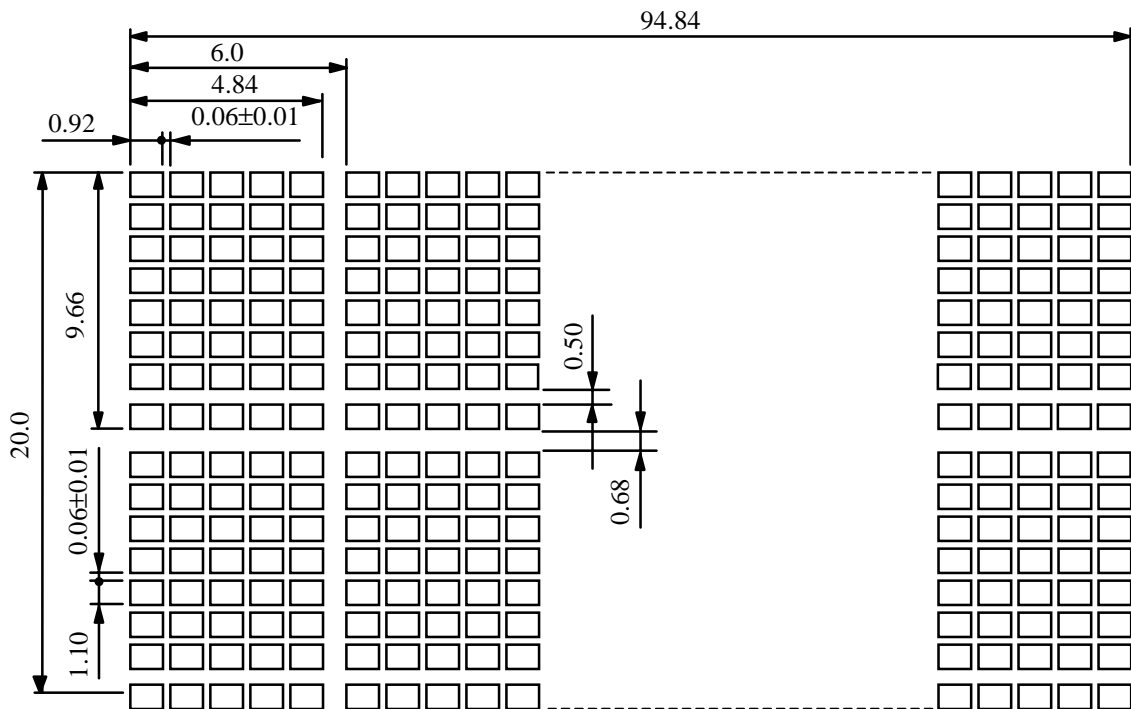

UNIT : mm
SCALE : NTS
NOT SPECIFIED TOLERANCE IS ±0.1

8. BLOCK DIAGRAM

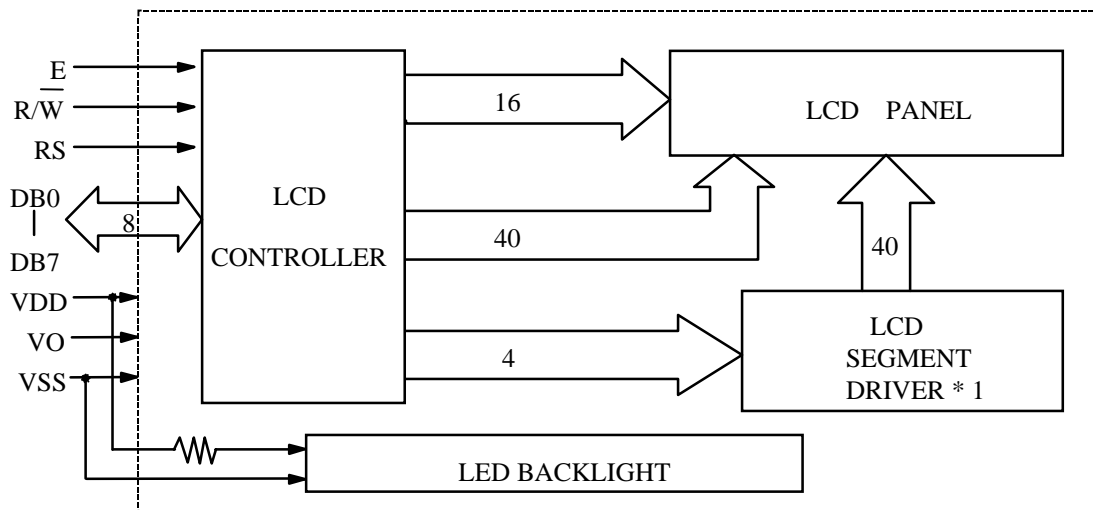

9. INTERFACE SIGNALS

PIN NO.	SYMBOL	DESCRIPTION	FUNCTION
1	VSS	GROUND	0V (GND)
2	VDD	POWER SUPPLY FOR LOGIC CIRCUIT	+5V
3	VO	LCD CONTRAST ADJUSTMENT	
4	RS	INSTRUCTION/DATA REGISTER SELECTION	RS = 0 : INSTRUCTION REGISTER RS = 1 : DATA REGISTER
5	$\overline{R/W}$	READ/WRITE SELECTION	$\overline{R/W}$ = 0 : REGISTER WRITE $\overline{R/W}$ = 1 : REGISTER READ
6	E	ENABLE INPUT	
7	DB0	DATA INPUT/OUTPUT LINES	4 BIT/8BIT SELECTABLE 4 BIT : DB4 - DB7 8 BIT : DB0 - DB7
8	DB1		
9	DB2		
10	DB3		
11	DB4		
12	DB5		
13	DB6		
14	DB7		

10. POWER SUPPLY

10.1 POWER SUPPLY FOR LCD MODULE

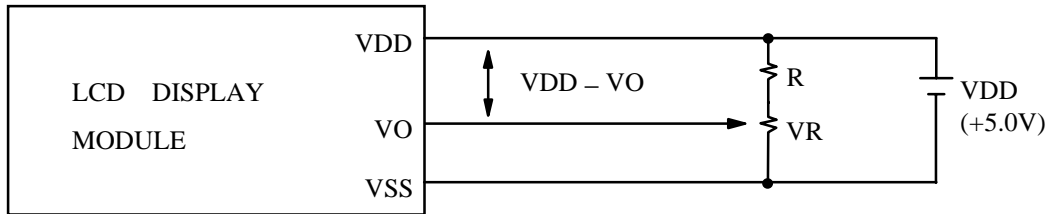

VDD - VO : LCD DRIVING VOLTAGE

VR : 10KΩ ~ 20KΩ

RECOMMENDED RESISTOR R : $VDD - VO \geq 1.5V$

11. DISPLAY DATA RAM ADDRESS

CHARACTER	1	2	3	4	5	6	7	8	9	10	11	12	13	14	15	16
LINE 1	80	81	82	83	84	85	86	87	88	89	8A	8B	8C	8D	8E	8F
LINE 2	C0	C1	C2	C3	C4	C5	C6	C7	C8	C9	CA	CB	CC	CD	CE	CF