



Capacitors for Power Electronics

Series/Type: **B25667A**

The following products presented in this data sheet are being withdrawn.

Ordering Code	Substitute Product	Date of Withdrawal	Deadline Last Orders	Last Shipments
B25667A4117A365	B25667B5127A375	2004-09-10		

For further information please contact your nearest EPCOS sales office, which will also support you in selecting a suitable substitute. The addresses of our worldwide sales network are presented at www.epcos.com/sales.

Characteristics

C_N	Δ	3x 38,4 μ F \pm 5 %	
U_N		AC 480 V	
f_N		50 Hz	60 Hz
Q_N		8,33 kvar	10 kvar
I_N		3x 10 A	12 A
$\tan \delta_0$		0,2 W/kvar (dielectric)	

Maximum ratings

U_{max}	AC 530 V, 8 h daily
	AC 620 V, 1 min
$I_r(40)$	3x 20 A ($\Theta_A = 40^\circ\text{C}$, U_N)
I_s	2700 A
$(du/dt)_{max}$	16 V/ μ s
$(du/dt)_s$	40 V/ μ s

Test data

U_{TT}	AC 1050 V, 10 s
U_{TC}	AC 3000 V, 10 s
$\tan \delta$ (50 Hz)	\leq 0,5 W/kvar (total)

Climatic category -40/D

Θ_{min}	-40 °C
Θ_{max}	+55 °C
Humidity	Max. relative Humidity \leq 95 %
Θ_{stg}	-55 bis +70 °C

Life expectancy

t_{LD}	100 000 h
----------	-----------

Remarks

Natural cooling

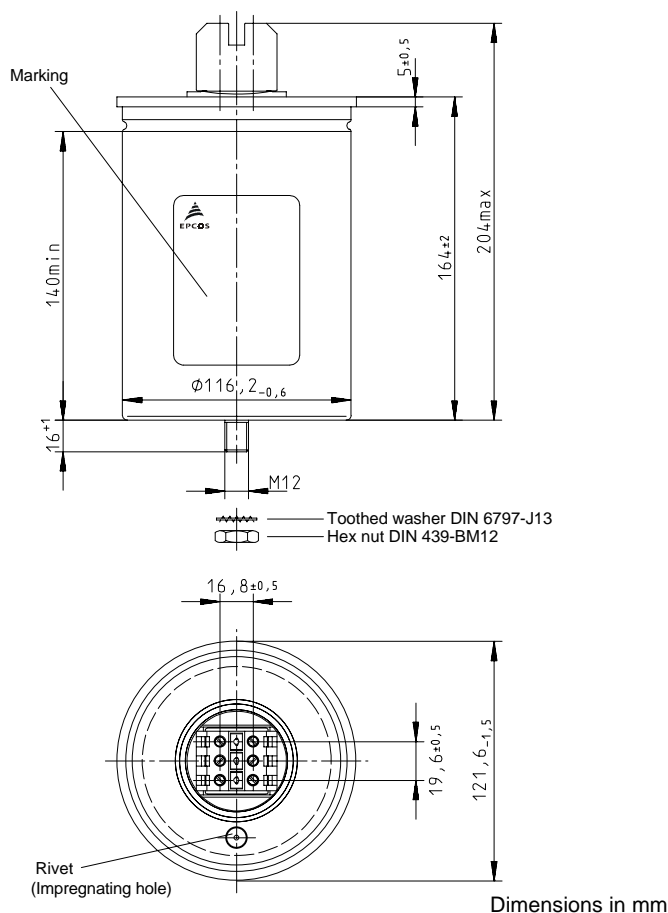

Design data

Dimensions \varnothing x l	121,6 x 164 mm (4,79 x 6,46 in)
Approx. weight	1,2 kg (2,6 lb)
Impregnation	Gas
Fixing	Threaded bolt M12
Mounting hole	14 mm (0,55 in)
Max. torque	10 Nm
Terminals	Isolated terminal, IP20
Max. torque	1,2 Nm
Terminal cross section	16 mm ² (5 AWG)
Creepage distance	12,7 mm (0,50 in)
Clearance	9,6 mm (0,38 in)
Overpressure disconnecter	
Any mounting position possible	