



**Advanced Power  
Electronics Corp.**

**AP10N70R/P**

**RoHS-compliant Product**

*N-CHANNEL ENHANCEMENT MODE*

*POWER MOSFET*

- ▼ 100% Avalanche Test
- ▼ Fast Switching Characteristic
- ▼ Simple Drive Requirement

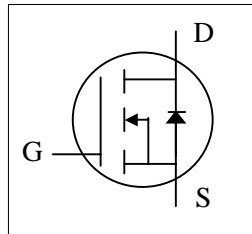

|              |              |
|--------------|--------------|
| $BV_{DSS}$   | 600V         |
| $R_{DS(ON)}$ | 0.6 $\Omega$ |
| $I_D$        | 10A          |

## Description

AP10N70 series are specially designed as main switching devices for universal 90~265VAC off-line AC/DC converter applications. Both TO-220 and TO-262 type provide high blocking voltage to overcome voltage surge and sag in the toughest power system with the best combination of fast switching, ruggedized design and cost-effectiveness.

The TO-220 and TO-262 package is widely preferred for commercial-industrial applications. The device is suited for switch mode power supplies, DC-AC converters and high current high speed switching circuits.

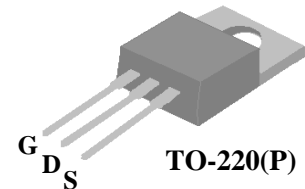
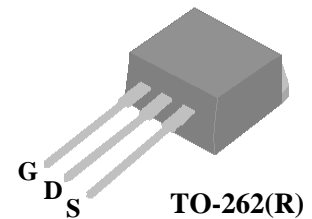

## Absolute Maximum Ratings

| Symbol                | Parameter                                  | Rating     | Units         |
|-----------------------|--|------------|---------------|
| $V_{DS}$              | Drain-Source Voltage                       | 600        | V             |
| $V_{GS}$              | Gate-Source Voltage                        | $\pm 30$   | V             |
| $I_D@T_C=25^\circ C$  | Continuous Drain Current, $V_{GS}$ @ 10V   | 10         | A             |
| $I_D@T_C=100^\circ C$ | Continuous Drain Current, $V_{GS}$ @ 10V   | 6.3        | A             |
| $I_{DM}$              | Pulsed Drain Current <sup>1</sup>          | 40         | A             |
| $P_D@T_C=25^\circ C$  | Total Power Dissipation                    | 174        | W             |
|                       | Linear Derating Factor                     | 1.39       | W/ $^\circ C$ |
| $E_{AS}$              | Single Pulse Avalanche Energy <sup>2</sup> | 50         | mJ            |
| $I_{AR}$              | Avalanche Current                          | 10         | A             |
| $T_{STG}$             | Storage Temperature Range                  | -55 to 150 | $^\circ C$    |
| $T_J$                 | Operating Junction Temperature Range       | -55 to 150 | $^\circ C$    |

## Thermal Data

| Symbol | Parameter                                    | Value | Unit         |
|--------|--|-------|--------------|
| Rthj-c | Maximum Thermal Resistance, Junction-case    | 0.72  | $^\circ C/W$ |
| Rthj-a | Maximum Thermal Resistance, Junction-ambient | 62    | $^\circ C/W$ |



## Electrical Characteristics @ $T_j=25^{\circ}\text{C}$ (unless otherwise specified)

| Symbol       | Parameter  | Test Conditions               | Min. | Typ. | Max.      | Units    |
|--------------|--|-------------------------------|------|------|-----------|----------|
| $BV_{DSS}$   | Drain-Source Breakdown Voltage                             | $V_{GS}=0V, I_D=1.0mA$        | 600  | -    | -         | V        |
| $R_{DS(ON)}$ | Static Drain-Source On-Resistance                          | $V_{GS}=10V, I_D=5.0A$        | -    | -    | 0.6       | $\Omega$ |
| $V_{GS(th)}$ | Gate Threshold Voltage                                     | $V_{DS}=V_{GS}, I_D=250\mu A$ | 2    | -    | 4         | V        |
| $g_{fs}$     | Forward Transconductance                                   | $V_{DS}=10V, I_D=5A$          | -    | 5    | -         | S        |
| $I_{DSS}$    | Drain-Source Leakage Current ( $T_j=25^{\circ}\text{C}$ )  | $V_{DS}=600V, V_{GS}=0V$      | -    | -    | 10        | $\mu A$  |
|              | Drain-Source Leakage Current ( $T_j=150^{\circ}\text{C}$ ) | $V_{DS}=480V, V_{GS}=0V$      | -    | -    | 100       | $\mu A$  |
| $I_{GSS}$    | Gate-Source Leakage  | $V_{GS}=\pm 30V$              | -    | -    | $\pm 100$ | nA       |
| $Q_g$        | Total Gate Charge <sup>3</sup>                             | $I_D=10A$                     | -    | 35.9 | 57        | nC       |
| $Q_{gs}$     | Gate-Source Charge   | $V_{DS}=480V$                 | -    | 8.3  | -         | nC       |
| $Q_{gd}$     | Gate-Drain ("Miller") Charge                               | $V_{GS}=10V$                  | -    | 11.5 | -         | nC       |
| $t_{d(on)}$  | Turn-on Delay Time <sup>3</sup>                            | $V_{DD}=300V$                 | -    | 14.9 | -         | ns       |
| $t_r$        | Rise Time  | $I_D=10A$                     | -    | 19.7 | -         | ns       |
| $t_{d(off)}$ | Turn-off Delay Time  | $R_G=10\Omega, V_{GS}=10V$    | -    | 51.7 | -         | ns       |
| $t_f$        | Fall Time  | $R_D=30\Omega$                | -    | 23.3 | -         | ns       |
| $C_{iss}$    | Input Capacitance  | $V_{GS}=0V$                   | -    | 1950 | 3120      | pF       |
| $C_{oss}$    | Output Capacitance   | $V_{DS}=15V$                  | -    | 630  | -         | pF       |
| $C_{rss}$    | Reverse Transfer Capacitance                               | $f=1.0MHz$                    | -    | 20   | -         | pF       |
| $R_g$        | Gate Resistance  | $f=1.0MHz$                    | -    | 2    | 3         | $\Omega$ |

## Source-Drain Diode

| Symbol   | Parameter                          | Test Conditions                              | Min. | Typ. | Max. | Units   |
|----------|------------------------------------|--|------|------|------|---------|
| $V_{SD}$ | Forward On Voltage <sup>3</sup>    | $T_j=25^{\circ}\text{C}, I_S=10A, V_{GS}=0V$ | -    | -    | 1.5  | V       |
| $t_{rr}$ | Reverse Recovery Time <sup>3</sup> | $I_S=10A, V_{GS}=0V,$                        | -    | 575  | -    | ns      |
| $Q_{rr}$ | Reverse Recovery Charge            | $di/dt=100A/\mu s$                           | -    | 10.6 | -    | $\mu C$ |

### Notes:

1. Pulse width limited by Max. junction temperature.
2. Starting  $T_j=25^{\circ}\text{C}$ ,  $V_{DD}=50V$ ,  $L=1.0mH$ ,  $R_G=25\Omega$ ,  $I_{AS}=10A$ .
3. Pulse test

THIS PRODUCT IS AN ELECTROSTATIC SENSITIVE, PLEASE HANDLE WITH CAUTION.

THIS PRODUCT HAS BEEN QUALIFIED FOR CONSUMER MARKET. APPLICATIONS OR USES AS CRITERIAL COMPONENT IN LIFE SUPPORT DEVICE OR SYSTEM ARE NOT AUTHORIZED.

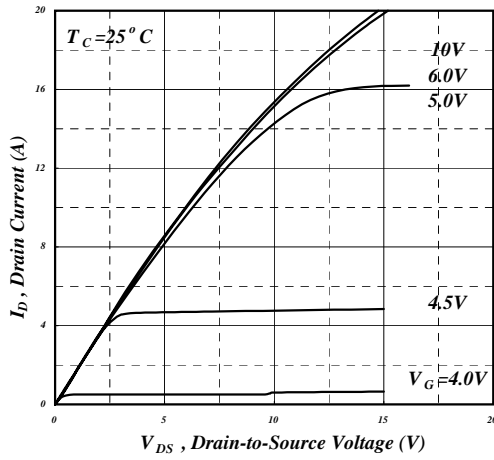

Fig 1. Typical Output Characteristics

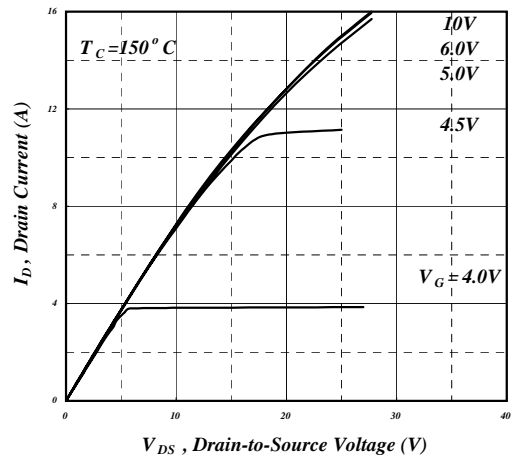

Fig 2. Typical Output Characteristics

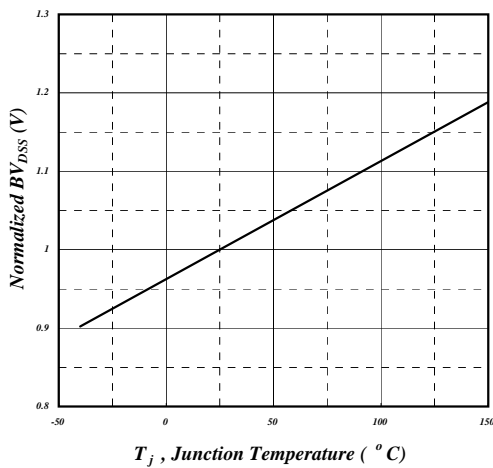

Fig 3. Normalized  $BV_{DSS}$  v.s. Junction Temperature

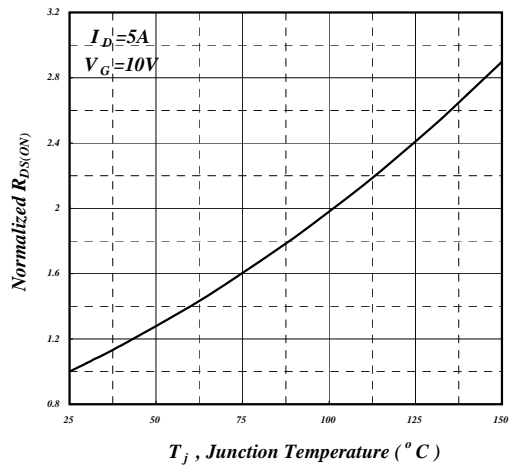

Fig 4. Normalized On-Resistance v.s. Junction Temperature

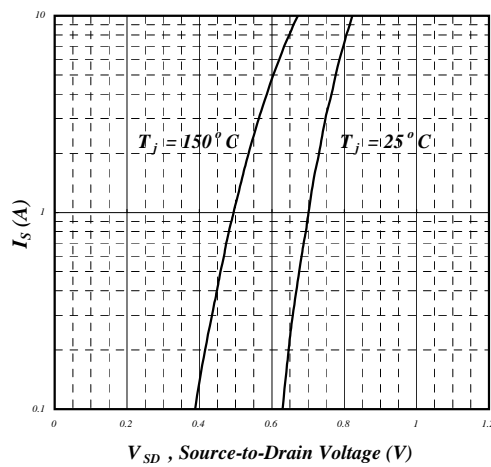

Fig 5. Forward Characteristic of Reverse Diode

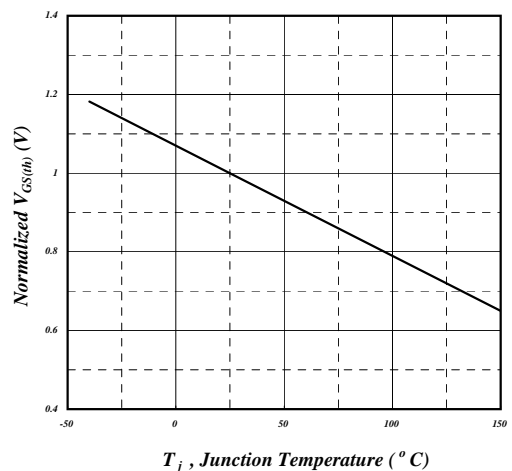

Fig 6. Gate Threshold Voltage v.s. Junction Temperature



# AP10N70P/R

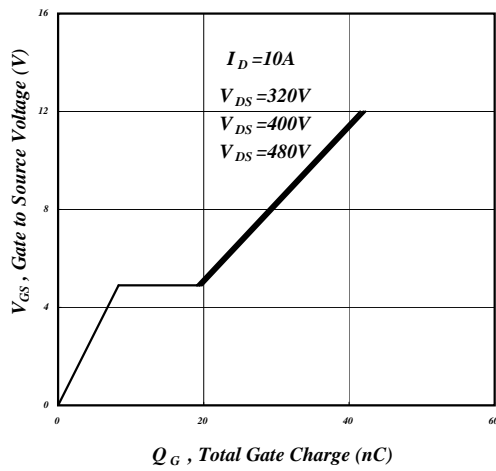

Fig 7. Gate Charge Characteristics

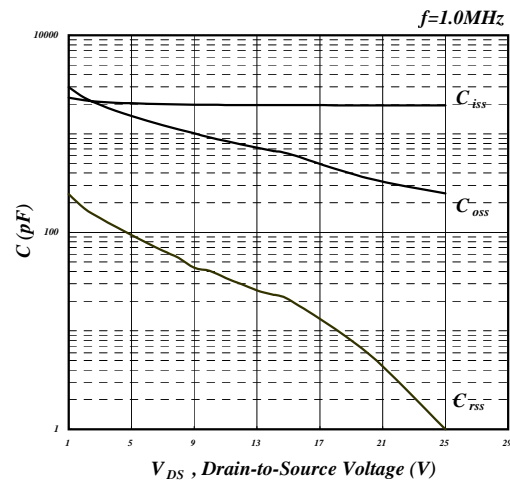

Fig 8. Typical Capacitance Characteristics

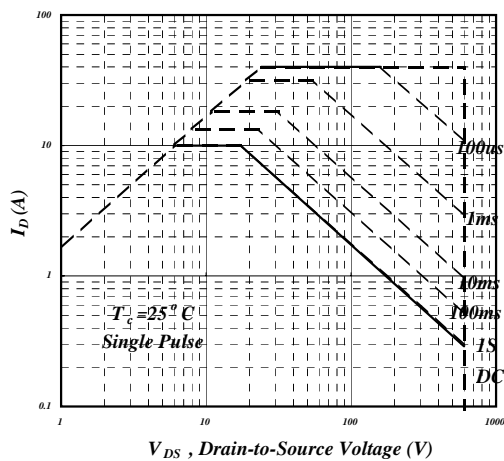

Fig 9. Maximum Safe Operating Area

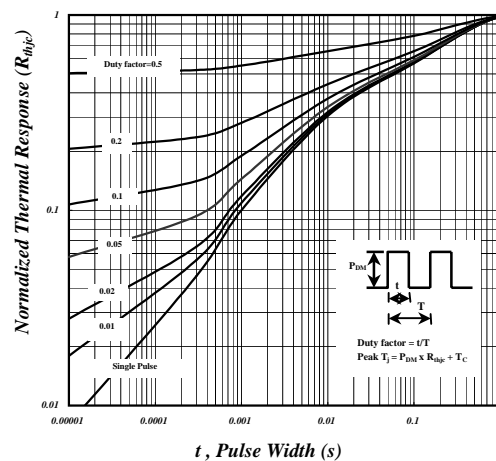

Fig 10. Effective Transient Thermal Impedance

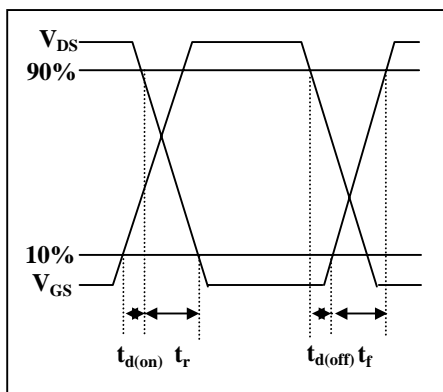

Fig 11. Switching Time Waveform

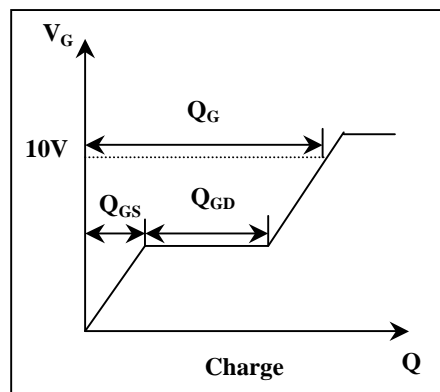
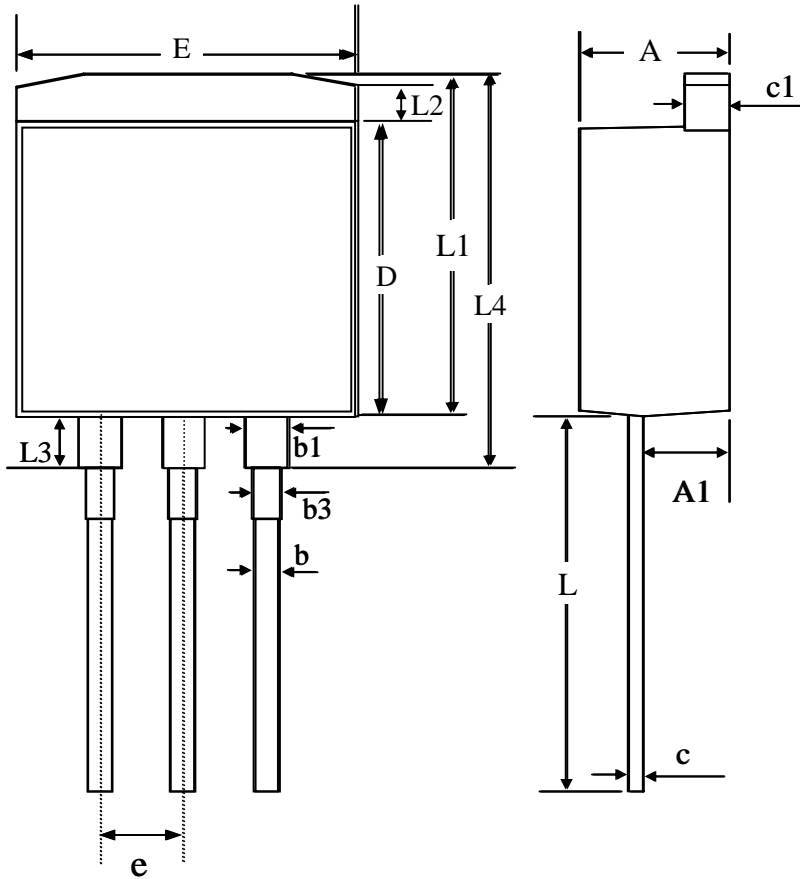

Fig 12. Gate Charge Waveform



### Package Outline : TO-262



| SYMBOLS | Millimeters |       |       |
|---------|-------------|-------|-------|
|         | MIN         | NOM   | MAX   |
| A       | 4.24        | 4.44  | 4.64  |
| A1      | -----       | ----- | 2.70  |
| b       | 0.66        | 0.76  | 0.86  |
| b1      | 1.07        | 1.27  | 1.47  |
| b3      | 0.76        | 0.86  | 1.06  |
| c       | 0.30        | 0.40  | 0.50  |
| c1      | 1.15        | 1.30  | 1.45  |
| D       | 8.30        | 8.60  | 8.90  |
| E       | 9.90        | 10.20 | 10.50 |
| e       | 2.04        | 2.54  | 3.04  |
| L       | 10.50       | 11.00 | 11.50 |
| L1      | 9.50        | 10.00 | 10.30 |
| L3      | ----        | 1.30  | ----  |
| L4      | 10.80       | 11.30 | 11.35 |

- 1.All Dimensions Are in Millimeters.
- 2.Dimension Does Not Include Mold Protrusions.

### Part Marking Information & Packing : TO-262

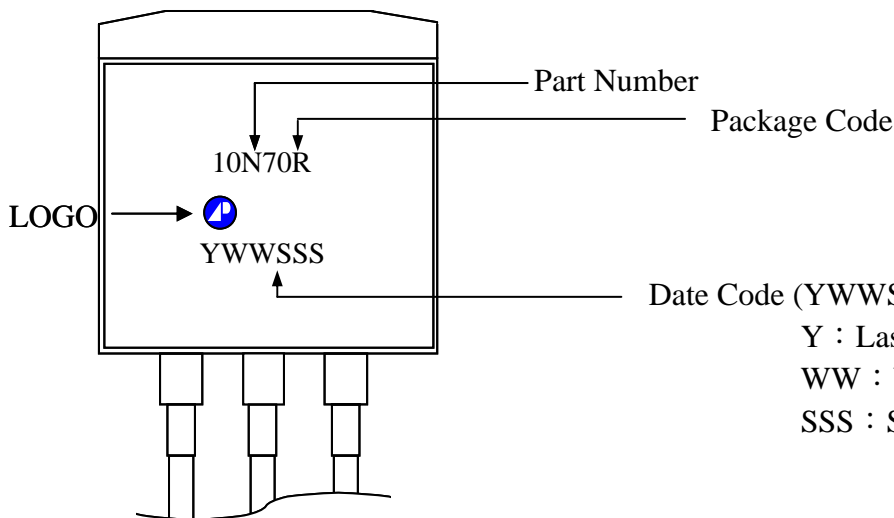

Y : Last Digit Of The Year  
 WW : Week  
 SSS : Sequence



### Package Outline : TO-220

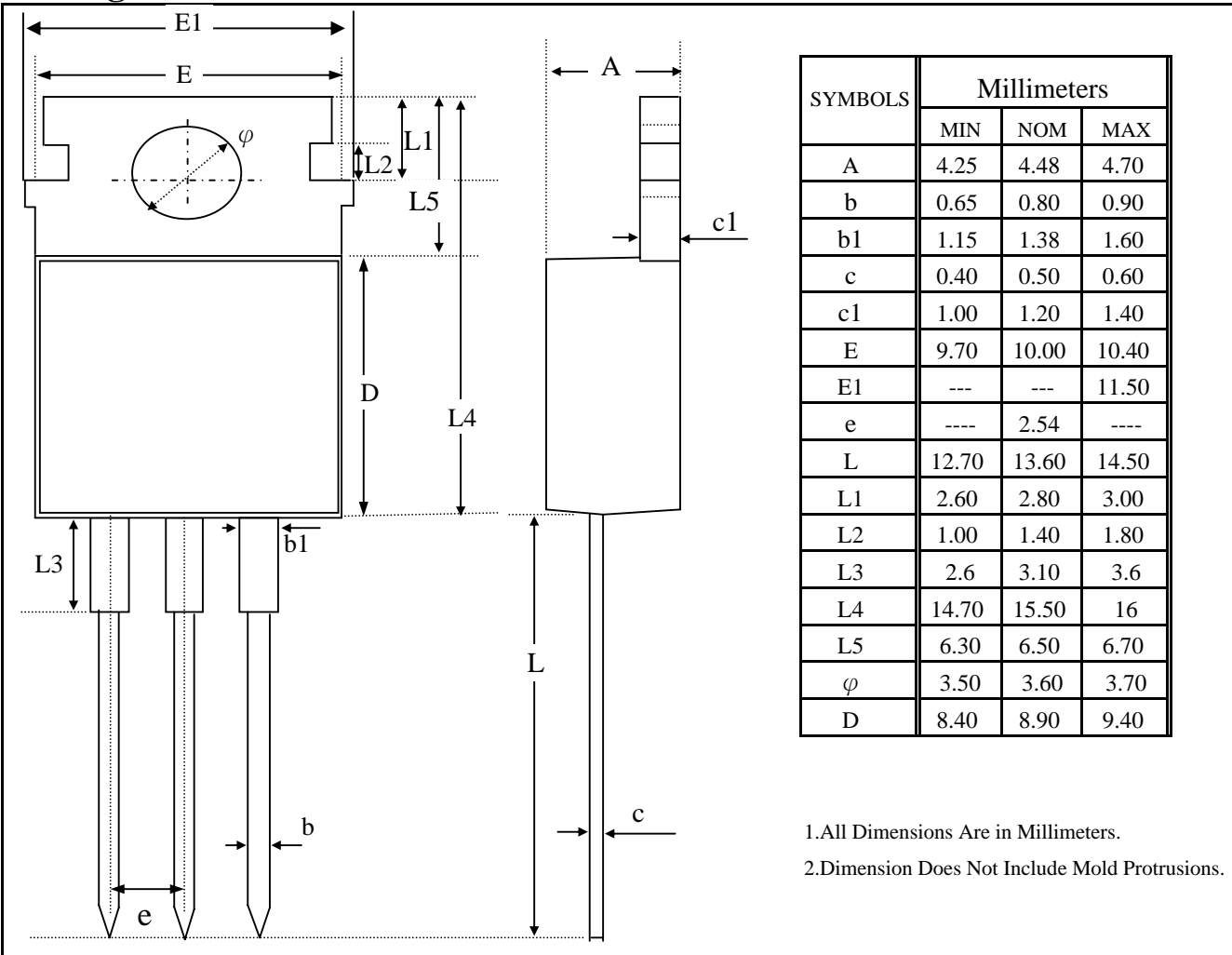

### Part Marking Information & Packing : TO-220

