

SMD 2.45GHz Dielectric Band Pass Filter

ADFC15-2450.00-A-T

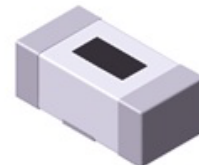

RoHS
Compliant



1.0 x 0.5 x 0.38mm

FEATURES:

- Small and low profile enables high density mounting
- Low insertion loss & attenuation
- Internally shielded for enhanced performance
- Excellent solderability

APPLICATIONS:

- Mobile communication system
- Bluetooth, Wireless LAN, WIFI, GPS, etc.

STANDARD SPECIFICATIONS:

Parameters	Minimum	Typical	Maximum	Units	Notes
Center Frequency (f_0)		2450.00		MHz	
Passband width	2400.00		2500.00	MHz	
Insertion Loss (2400 ~ 2500MHz)			1.4	dB	@+25°C
			1.7	dB	@ -40 ~ +85°C
Amplitude Ripple (2400 ~ 2500MHz)			0.5	dB	
V.S.W.R (2400 ~ 2500MHz)			1.5		
Relative Attenuation (Reference level: 0dB)	25			dB	800 ~ 960MHz
	8				1710 ~ 1970MHz
	23				4800 ~ 5000MHz
	32				7200 ~ 7500MHz
Characteristic Impedance		50		Ω	
Operation Temperature Range	-40		+85	°C	
Storage Temperature Range	-10		+40	°C	RH 70% Max

CHARACTERISTIC CURVE:

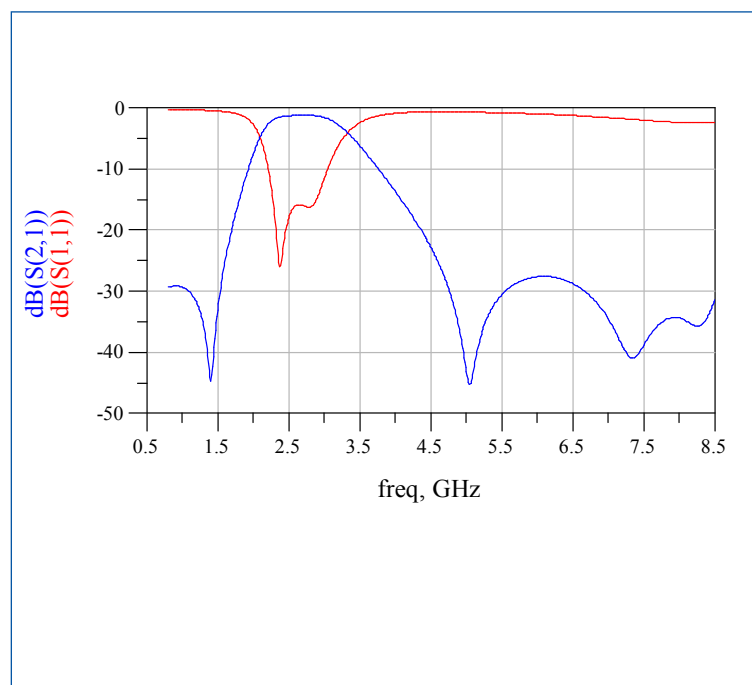

REFLOW PROFILE:

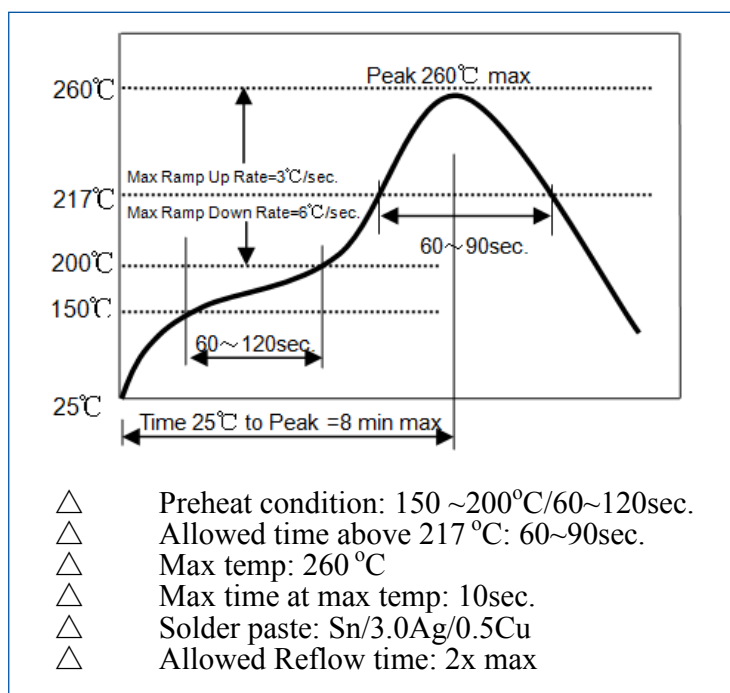

SMD 2.45GHz Dielectric Band Pass Filter

ADFC15-2450.00-A-T



RoHS
Compliant

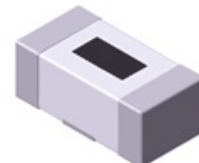

1.0 x 0.5 x 0.38mm

OUTLINE DRAWING:

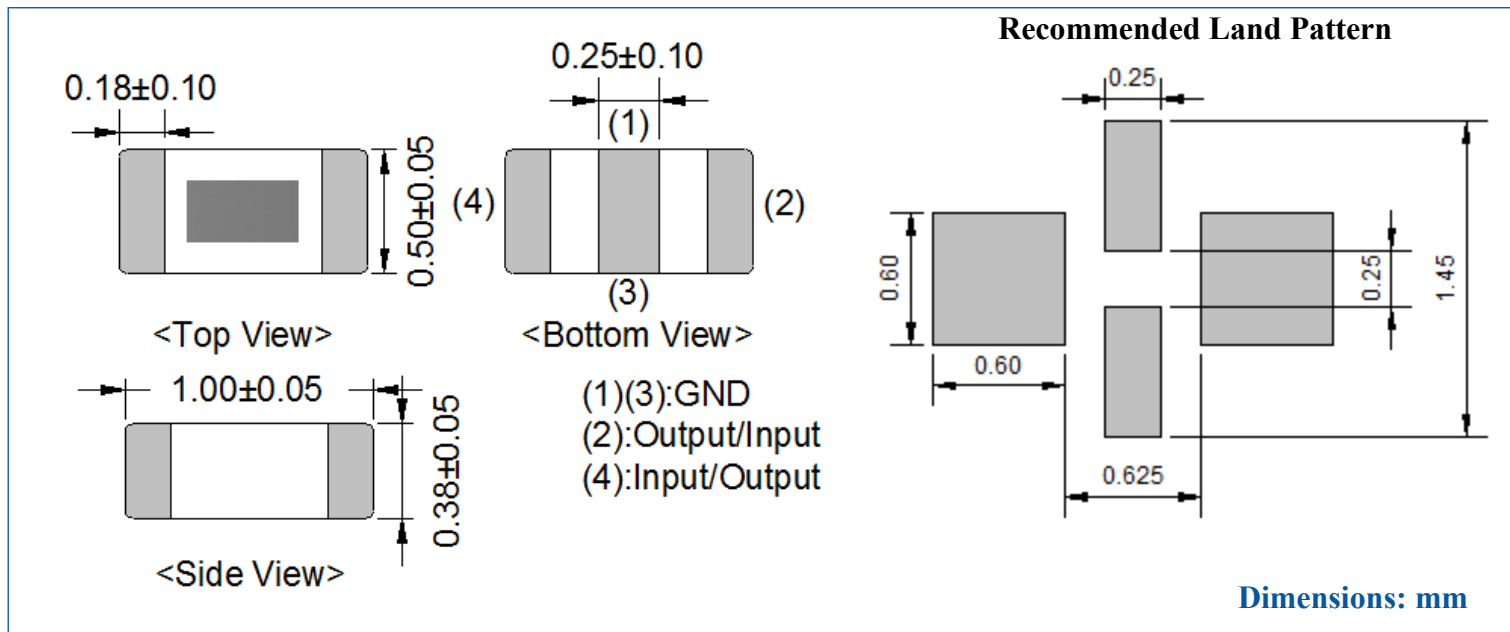

TAPE & REEL:

Packaging: 10,000pcs/reel

Chip Cavity

Sprocket Hole $\Phi 1.5 (+0.1,0)$

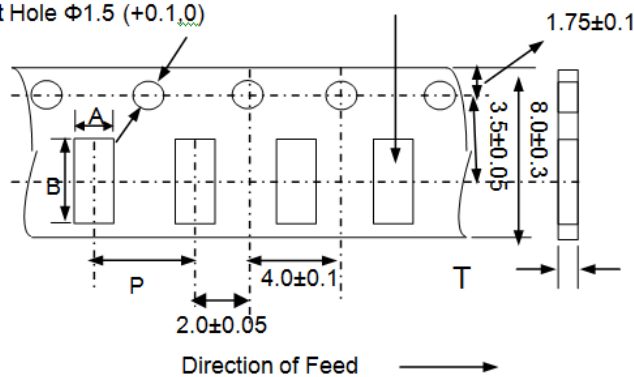

A	B	P	T max
0.62±0.03	1.12±0.03	2.00±0.05	0.45

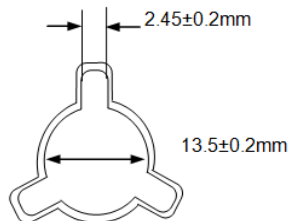
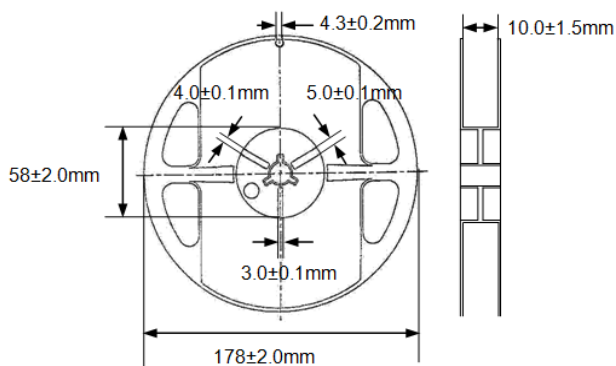

Dimensions: mm

ATTENTION: Abracon Corporation's products are COTS – Commercial-Off-The-Shelf products; suitable for Commercial, Industrial and, where designated, Automotive Applications. Abracon's products are not specifically designed for Military, Aviation, Aerospace, Life-dependant Medical applications or any application requiring high reliability where component failure could result in loss of life and/or property. For applications requiring high reliability and/or presenting an extreme operating environment, written consent and authorization from Abracon Corporation is required. Please contact Abracon Corporation for more information.

ABRACON IS
ISO 9001:2008
CERTIFIED

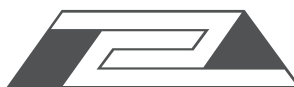

ABRACON
CORPORATION

Visit www.abracon.com for Terms & Conditions of Sale
30332 Esperanza, Rancho Santa Margarita, California 92688
tel 949-546-8000 | fax 949-546-8001 | www.abracon.com

Revised: 12.03.12