

mm inch

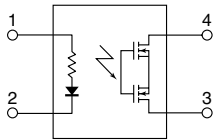

RoHS compliant

FEATURES

1. Built-in input resistor means less man-hours when mounting

The voltage-sensitive type, which eliminates the need to mount an external input resistor, is now available in a small package. Man-hours spent mounting external input resistors are cut and board designing is simplified.

2. Save space on PC board

Since the small package size remains the same while including a built-in input resistor, space on the PC board is saved. This makes it easier to incorporate space savings when designing miniature devices.

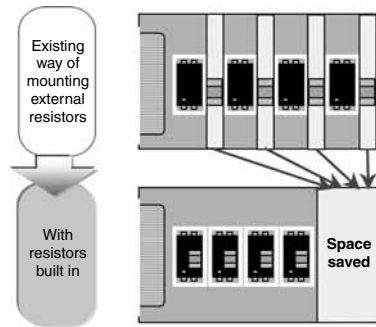

<Artistic impression of PC board space savings due to built-in resistor>

3. Both low on-resistance (R type) and low capacitance (C type) available at excellent electrical characteristics of C×R10

- R type: On resistance 0.75Ω (typ.)
Output resistance 12.5pF (typ.)
- C type: On resistance 9.5Ω (typ.)
Output capacitance 1pF (typ.)

TYPICAL APPLICATIONS

1. Measuring and testing equipment

Semiconductor testing equipment, Probe cards, Datalogger, Board tester and other testing equipment.

2. Telecommunication and broadcasting equipment

3. Medical equipment

TYPES

	Type	Output rating*1		Package	Part No.*2		Packing quantity in tape and reel
		Load voltage	Load current		Tape and reel packing style (Picked from the 1 and 4-pin side)	Tape and reel packing style (Picked from the 2 and 3-pin side)	
AC/DC dual use	Low on-resistance (R type)	40 V	0.25A	SSOP	AQY221FR2VY	AQY221FR2VW	3,500 pcs.
	Low capacitance (C type)	40 V	0.12A		AQY221FN2VY	AQY221FN2VW	

Notes: *1 Indicate the peak AC and DC values.

*2 Tape and reel is the standard packing style for SSOP.

For space reasons, the three initial letters of the part number "AQY", and the package (SSOP) indicator "V" and the packing style indicator "Y" or "W" are not marked on the device. (Ex. the label for product number AQY221FR2VY is 221FR2)

RATING

1. Absolute maximum ratings (Condition: ambient temperature 25°C 77°F)

Item		Symbol	AQY221FR2V	AQY221FN2V	Remarks
Input	Input voltage	V_{IN}	6V		
	Input reverse voltage	V_{RIN}	5V		
	Power dissipation	P_{in}	65mW		
Output	Load voltage (peak AC)	V_L	40V		
	Load current	I_L	0.25A	0.12A	Peak AC, DC
	Peak load current	I_{peak}	0.75A	0.2A	100ms (1shot), $V_L=DC$
	Power dissipation	P_{out}	250mW		
Total power dissipation		P_T	300mW		
I/O isolation voltage		V_{iso}	500V AC		
Operating temperature		T_{opr}	-40°C to +85°C -40°F to +185°F		Non-condensing at low temperatures
Storage temperature		T_{stg}	-40°C to +100°C -40°F to +212°F		

RF SSOP C×R10 Voltage-sensitive (AQY221F○2V)

2. Electrical characteristics (Condition: ambient temperature 25°C 77°F)

Item		Symbol	AQY221FR2V	AQY221FN2V	Condition
Input	Operate voltage	Typ.	1.3V		AQY221FR2V: I _L = Max. AQY221FN2V: I _L = 80mA
		Max.	4V		
	Turn off voltage	Min.	0.8V		
		Typ.	1.3V		
Input current	Typ.	8.5mA		V _{IN} = 5V	
Output	On resistance	Typ.	0.75Ω	9.5Ω	AQY221FR2V: V _{IN} = 5V, I _L = Max. AQY221FN2V: V _{IN} = 5V, I _L = 80mA Within 1 s on time
		Max.	1.25Ω	12.5Ω	
	Output capacitance	Typ.	12.5pF	1pF	V _{IN} = 0V, V _B = 0V, f = 1MHz
		Max.	18pF	1.5pF	
	Off state leakage current	Typ.	0.02nA	0.01nA	V _{IN} = 0V, V _L = Max.
		Max.	10nA		
Transfer characteristics	Turn on time*	Typ.	0.05ms	0.01ms	AQY221FR2V: V _{IN} = 5V, V _L = 10V, R _L = 40Ω AQY221FN2V: V _{IN} = 5V, V _L = 10V, R _L = 125Ω
		Max.	0.5ms		
	Turn off time*	Typ.	0.06ms	0.03ms	V _{IN} = 5V, V _L = 10V, R _L = 125Ω
		Max.	0.2ms		
	I/O capacitance	Typ.	0.8pF		f = 1MHz, V _B = 0V
		Max.	1.5pF		f = 1MHz, V _B = 0V
	Initial I/O isolation resistance	Min.	1,000MΩ		500V DC

Note: If you wish to change the input voltage, rating or performance, please inquire with our sales.

*Turn on/Turn off time

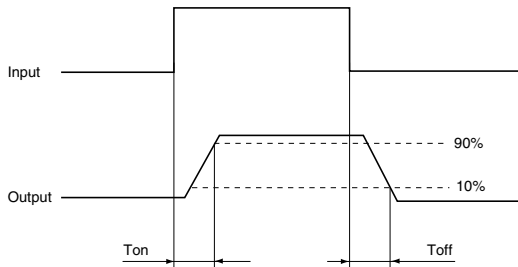

RECOMMENDED OPERATING CONDITIONS

Please obey the following conditions to ensure proper device operation and resetting.

Item	Symbol	Minimum	Typical	Maximum	Unit
Input voltage	V _{IN}	4.5	5	5.5	V

- For Dimensions.
- For Schematic and Wiring Diagrams.
- For Cautions for Use.

■ These products are not designed for automotive use.

If you are considering to use these products for automotive applications, please contact your local Panasonic Corporation technical representative.
For more information.

RF SSOP C×R10 Voltage-sensitive (AQY221F○2V)

REFERENCE DATA

1. Load current vs. ambient temperature characteristics

Allowable ambient temperature: -40°C to $+85^{\circ}\text{C}$
 -40°F to $+185^{\circ}\text{F}$

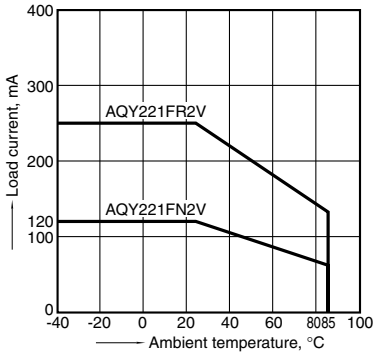

2. Load current vs. Load voltage characteristics

Ambient temperature: 25°C 77°F

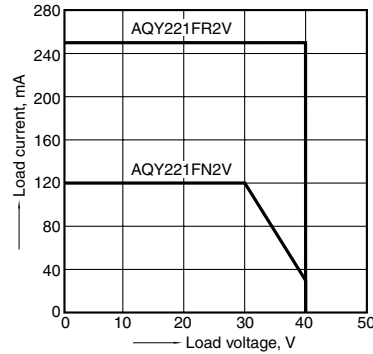

3. On resistance vs. ambient temperature characteristics

Measured portion: between terminals 3 and 4
 Input voltage: 5V; Load voltage: 10V (DC);
 Continuous load current: 80mA (DC)

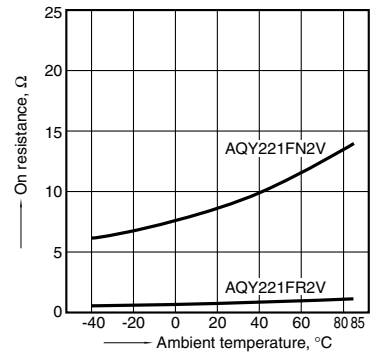

4. Turn on time vs. ambient temperature characteristics

Input voltage: 5V; Load voltage: 10V (DC);
 Continuous load current: 250mA (DC) R type,
 80mA (DC) C type

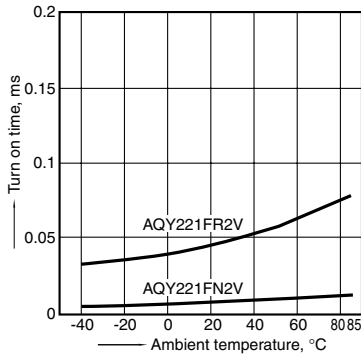

5. Turn off time vs. ambient temperature characteristics

Input voltage: 5V; Load voltage: 10V (DC);
 Continuous load current: 250mA (DC) R type,
 80mA (DC) C type

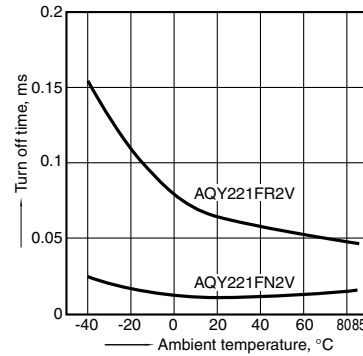

6. Turn on voltage vs. ambient temperature characteristics

Load voltage: 10V (DC);
 Continuous load current: 250mA (DC) R type,
 80mA (DC) C type

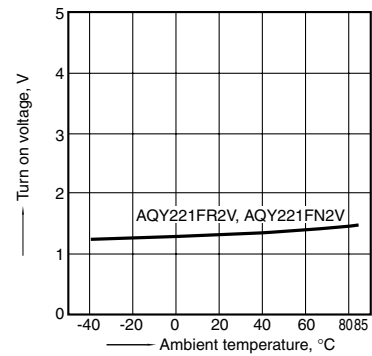

7. Turn off voltage vs. ambient temperature characteristics

Load voltage: 10V (DC);
 Continuous load current: 250mA (DC) R type,
 80mA (DC) C type

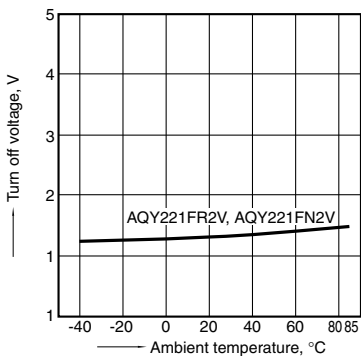

8. Input current vs. ambient temperature characteristics

Input voltage: 5V

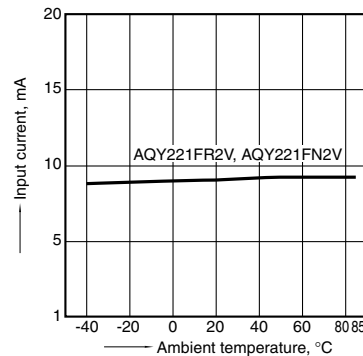

9. Current vs. voltage characteristics of output at MOS portion

Measured portion: between terminals 3 and 4
 Ambient temperature: 25°C 77°F

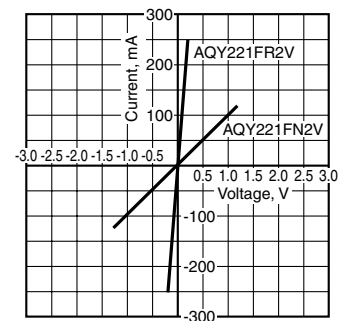

RF SSOP C×R10 Voltage-sensitive (AQY221F○2V)

10. Input current vs. input voltage characteristics

Ambient temperature: 25°C 77°F
(Recommended input voltage: 5±0.5V)

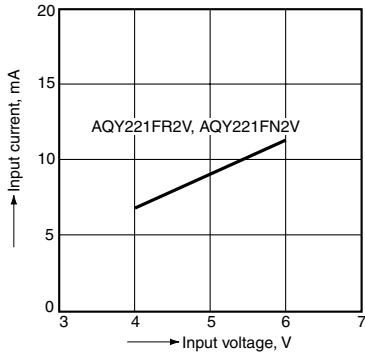

11. Off state leakage current vs. load voltage characteristics

Measured portion: between terminals 3 and 4
Ambient temperature: 25°C 77°F

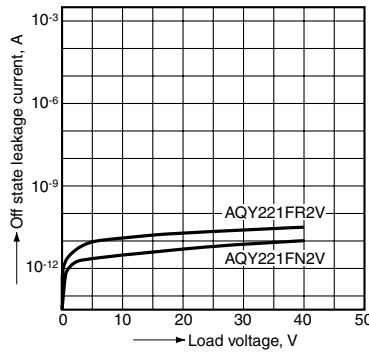

12. Turn on time vs. input voltage characteristics

Measured portion: between terminals 3 and 4
Load voltage: 10V (DC);
Continuous load current: 250mA (DC) R type,
80mA (DC) C type; Ambient temperature: 25°C 77°F

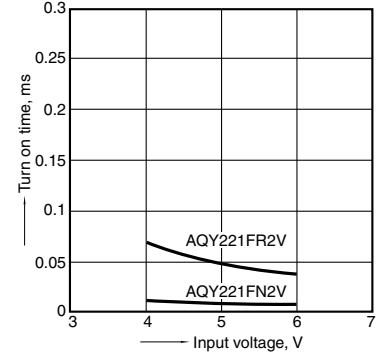

13. Turn off time vs. input voltage characteristics

Measured portion: between terminals 3 and 4
Load voltage: 10V (DC);
Continuous load current: 250mA (DC) R type,
80mA (DC) C type; Ambient temperature: 25°C 77°F

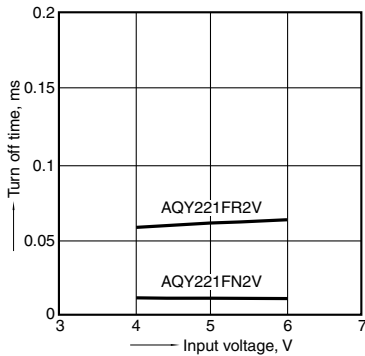

14. Output capacitance vs. applied voltage characteristics

Measured portion: between terminals 3 and 4
Frequency: 1 MHz, 30m Vrms;
Ambient temperature: 25°C 77°F

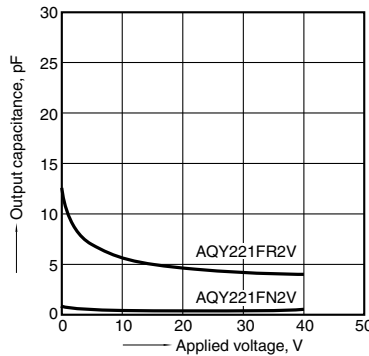

15. Isolation vs. frequency characteristics (50Ω impedance)

Measured portion: between terminals 3 and 4
Ambient temperature: 25°C 77°F

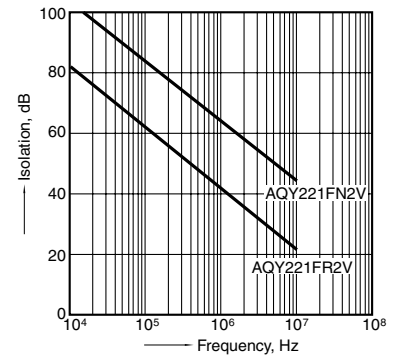

16. Insertion loss vs. frequency characteristics (50Ω impedance)

Measured portion: between terminals 3 and 4
Ambient temperature: 25°C 77°F

