

UCC28019AEVM 350-W PFC Converter

User's Guide



Literature Number: SLUU325A
June 2008–Revised May 2009

UCC28019A EVM 350-W PFC Converter

The UCC28019A evaluation module (EVM) is a 350-W off-line Power Factor Correction (PFC) boost converter providing a 390-V regulated output at 0.9 A of load current. The PFC converter accommodates an input voltage range of 85 VAC to 265 VAC and uses average current mode control at a fixed frequency of 65 kHz. The UCC28019A incorporates a wide range of protection features to ensure safe system operation.

1 Description

The UCC28019A EVM highlights the many benefits of using the UCC28019A Continuous Current Mode PFC Controller ([TI Literature Number SLUS828](#)). The controller operates under average current mode control at a fixed frequency of 65 kHz. Simple external current and voltage loop compensation, along with advanced protection features, make this controller ideal for server and desktop power supplies, telecom rectifiers, and home electronics.

This user's guide provides the schematic, component list, assembly drawing for a single-sided printed circuit board application, and test set up necessary to evaluate the UCC28019A in a typical PFC application.

2 Applications

The UCC28019A is suited for use in high-power off-line systems requiring high-efficiency and advanced fault protection features including:

- Server and desktop power supplies
- Telecom rectifiers
- Home electronics

3 Features

The UCC28019A EVM features include:

- 350-W, 390-V output
- Universal off-line input voltage range
- Average current mode PWM control
- Fixed 65-kHz oscillator frequency
- Cycle-by-cycle peak current limiting
- VCC under-voltage lockout
- Voltage regulation open-loop detection
- Output under-voltage protection
- Output over-voltage protection
- AC input brown-out protection
- Enhanced dynamic response
- Soft-start

4 UCC28019AEVM Electrical Performance Specification

CAUTION

High voltage levels are present on the evaluation module whenever it is energized. Proper precautions must be taken when working with the EVM. The large bulk capacitor across the output terminals must be completely discharged before the EVM can be handled. Serious injury can occur if proper safety precautions are not followed.

Table 1. UCC28019AEVM Performance Summary

	PARAMETER	TEST CONDITION	MIN	TYP	MAX	UNIT
Input Characteristics						
V_{IN}	Input voltage		85		265	VAC
f_{LINE}	Input frequency		47		63	Hz
$I_{IN(No_Load)}$	No load input current	$V_{IN} = 265\text{ VAC}$, $f_{LINE} = 50\text{ Hz}$ $I_{OUT} = 0\text{ A}$		80		mA
$I_{IN(MAX)}$	Maximum input current	$V_{IN} = 85\text{ VAC}$, $f_{LINE} = 50\text{ Hz}$ $I_{OUT} = 0.9\text{ A}$		4.5		A
$V_{IN(TURN_ON_THRESHOLD)}$	Brown out voltage	$I_{OUT} = 0.9\text{ A}$		82		VAC
$V_{IN(TURN_OFF_THRESHOLD)}$		$I_{OUT} = 0.9\text{ A}$		66		
Output Characteristics						
V_{OUT}	Output voltage	$85\text{ VAC} \leq V_{IN} \leq 265\text{ VAC}$ $47\text{ Hz} \leq f_{LINE} \leq 63\text{ Hz}$ $0\text{ A} \leq I_{OUT} \leq 0.9\text{ A}$	380	390	402	VDC
	Line regulation	$85\text{ VAC} \leq V_{IN} \leq 265\text{ VAC}$ $I_{OUT} = 0.45\text{ A}$		0.41%	5%	
	Load regulation	$V_{IN} = 115\text{ VAC}$, $f_{LINE} = 60\text{ Hz}$ $0\text{ A} \leq I_{OUT} \leq 0.9\text{ A}$		0.05%	5%	
		$V_{IN} = 230\text{ VAC}$, $f_{LINE} = 50\text{ Hz}$ $0\text{ A} \leq I_{OUT} \leq 0.9\text{ A}$		0.67%	5%	
$V_{RIPPLE(SW)}$	High frequency output voltage ripple	$V_{IN} = 115\text{ VAC}$, $f_{LINE} = 60\text{ Hz}$ $I_{OUT} = 0.9\text{ A}$		1.68	3.9	V _{P-P}
		$V_{IN} = 230\text{ VAC}$, $f_{LINE} = 50\text{ Hz}$ $I_{OUT} = 0.9\text{ A}$		1.12	3.9	
$V_{RIPPLE(f_LINE)}$	Line frequency output voltage ripple	$V_{IN} = 115\text{ VAC}$, $f_{LINE} = 60\text{ Hz}$ $I_{OUT} = 0.9\text{ A}$		10.8	19.5	
		$V_{IN} = 230\text{ VAC}$, $f_{LINE} = 50\text{ Hz}$ $I_{OUT} = 0.9\text{ A}$		12.4	19.5	
I_{OUT}	Output load current	$85\text{ VAC} \leq V_{IN} \leq 265\text{ VAC}$ $47\text{ Hz} \leq f_{LINE} \leq 63\text{ Hz}$			0.9	A
P_{OUT}	Output power				350	W
$V_{OUT(OVP)}^{(1)}$	Output over voltage protection		400.5	410.0	421.0	V
$V_{OUT(UVD)}^{(1)}$	Output under voltage detection		362	370	381	

(1) Will track V_{OUT} .

Table 1. UCC28019AEVM Performance Summary (continued)

	PARAMETER	TEST CONDITION	MIN	TYP	MAX	UNIT
Control Loop Characteristics						
f_{SW}	Switching frequency	$T_J = 25^\circ\text{C}$	61.7	65	68.3	kHz
$f_{(CO)}$	Control loop bandwidth	$V_{IN} = 162\text{ VDC},$ $I_{OUT} = 0.45\text{ A}$		14		Hz
	Phase margin	$V_{IN} = 162\text{ VDC},$ $I_{OUT} = 0.45\text{ A}$		70		degrees
PF	Power factor	$V_{IN} = 115\text{ VAC}, I_{OUT} = 0.9\text{ A}$	0.99			
THD	Total harmonic distortion	$V_{IN} = 115\text{ VAC}, f_{LINE} = 60\text{ Hz}$ $I_{OUT} = 0.9\text{ A}$		4.3%	10%	
		$V_{IN} = 230\text{ VAC}, f_{LINE} = 50\text{ Hz}$ $I_{OUT} = 0.9\text{ A}$		6.6%	10%	
η_{PEAK}	Peak efficiency	$V_{IN} = 265\text{ VAC}, f_{LINE} = 50\text{ Hz},$ $I_{OUT} = 0.9\text{ A}$		97.7%		
η_{FL}	Full Load Efficiency	$V_{IN} = 115\text{ VAC}, f_{LINE} = 60\text{ Hz},$ $I_{OUT} = 0.9\text{ A}$		94.9%		
T_A	Ambient Temperature			25		$^\circ\text{C}$

5 Schematic

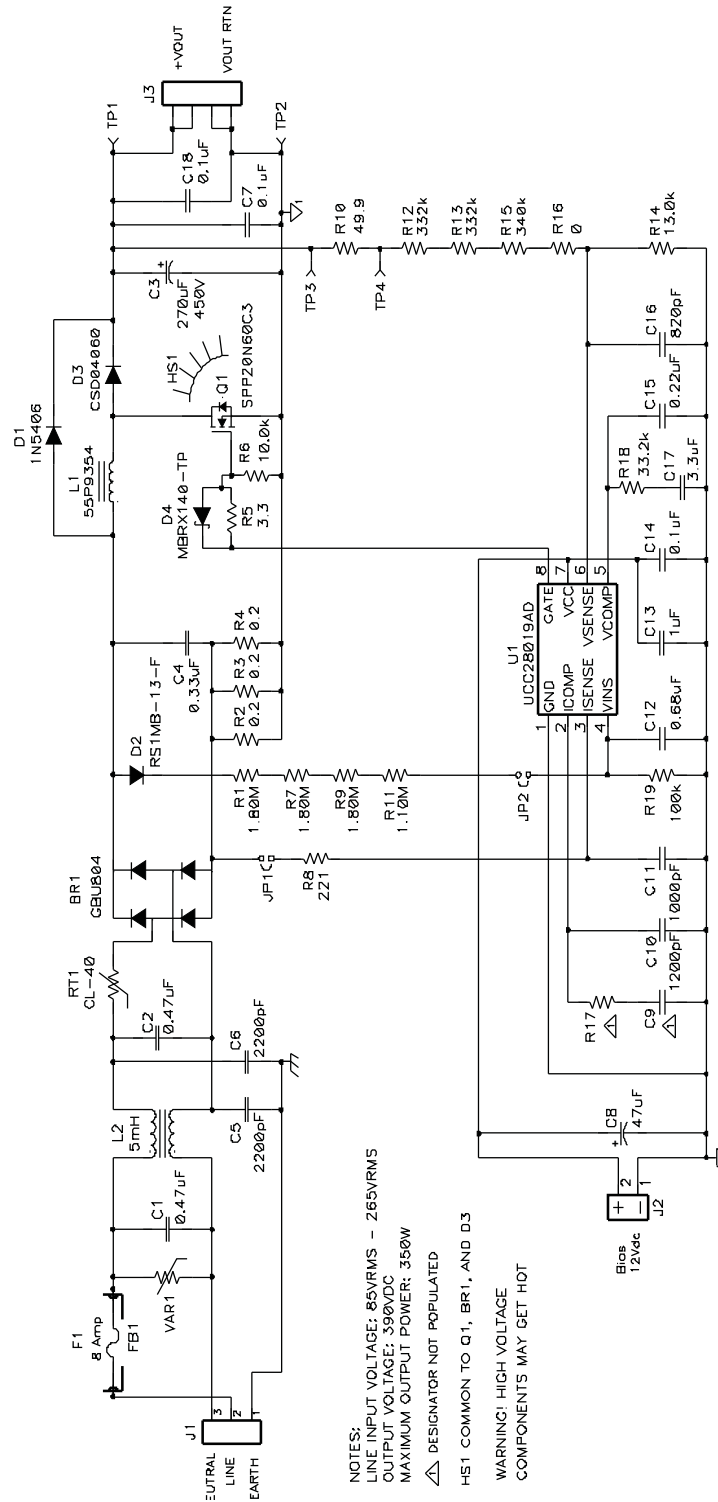

Figure 1. UCC28019AEVM Schematic

6 EVM Test Setup

Figure 2 shows the basic test set up recommended to evaluate the UCC28019AEVM.

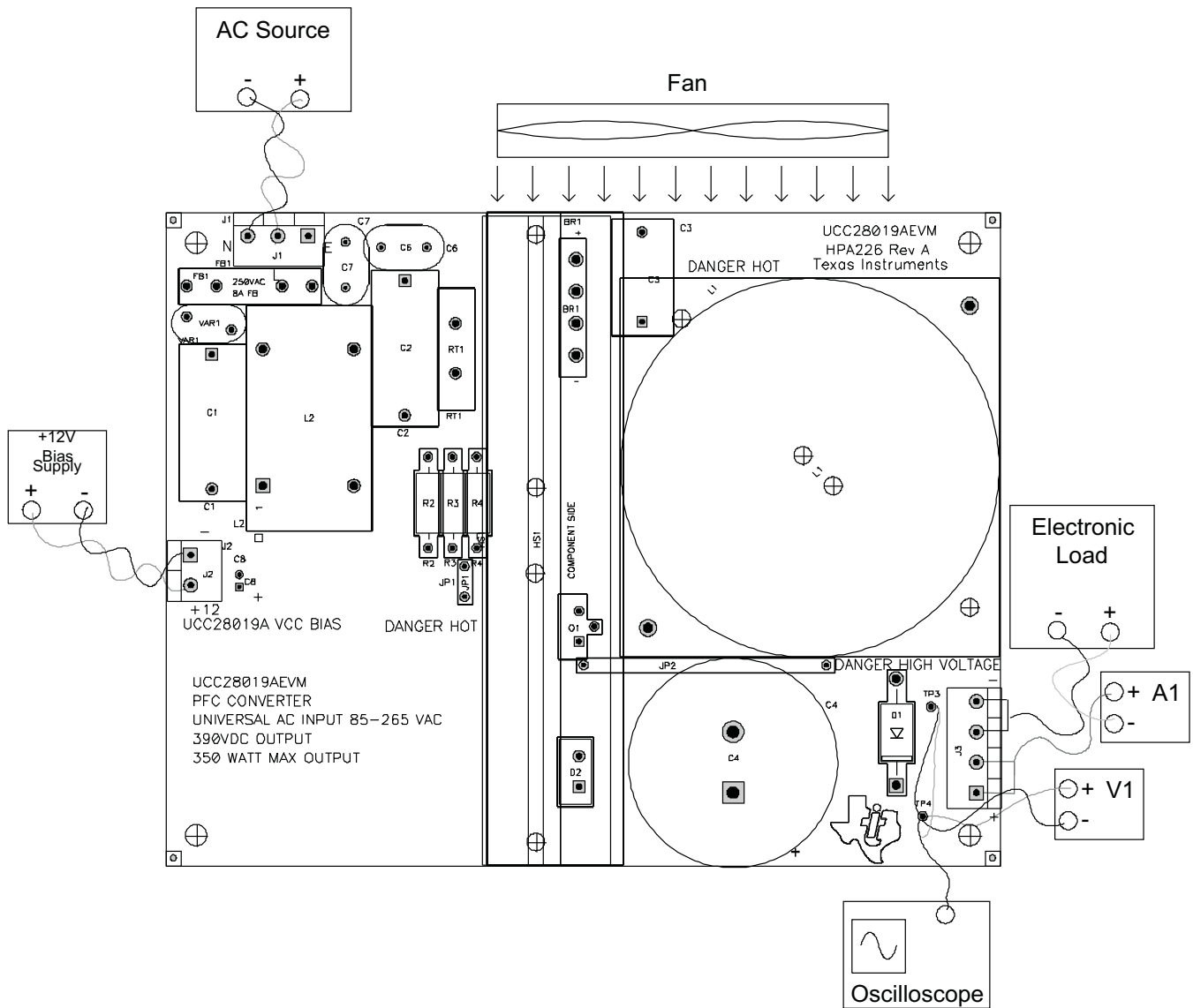

Figure 2. UCC28019AEVM Test Set Up

6.1 AC Source

The ac input source shall be capable of supplying between 85 VAC and 265 VAC at no less than 8 A peak. Connect the ac source to the L and N terminals of J1 on the EVM as shown in [Figure 2](#).

6.2 12-V Bias Supply

The bias supply to the device shall be capable of supplying up to 12 VDC at no less than 10 mA. Connect the bias supply to the – and +12 terminals of J2, UCC28019A VCC BIAS, as shown in [Figure 2](#).

6.3 Electronic Load

A programmable electronic load set to constant current mode and capable of sinking 0 A to 1 A at 390 VDC shall be used.

6.4 Digital Multimeters

For highest accuracy, the output voltage of the UCC28019AEVM shall be monitored by connecting a digital voltmeter, V1, directly across TP1 and TP2 with the positive terminal at TP1 and the negative terminal at TP2, as shown in [Figure 2](#). A dc current meter, A1, should be placed in series with the electronic load for accurate output current measurements.

6.5 Recommended Wire Gauge

The connection between the ac source and the EVM input terminals can carry as much as 8 A peak during brownout testing. The recommended wire size is AWG #16 with the total length of wire less than 8 feet (4 feet input, 4 feet return). The connection between the EVM output terminals (J3) and the electronic load can carry as much as 1 A. The minimum recommended wire size is AWG #20, with the total length of wire less than 8 feet (4 feet output, 4 feet return).

6.6 Fan

A fan, capable of 200 LFM to 400 LFM, should be used to maintain component temperatures within safe operating ranges at all times during operation of the UCC28019AEVM. Position the fan so as to blow along the length of the heatsink as shown in [Figure 2](#).

7 Power-Up/Power-Down Procedure

The following test procedure is recommended primarily for power up and shutting down the evaluation module. Never leave a powered EVM unattended for any length of time. Also, the unit should never be handled while power is applied to it or the output voltage is greater than 50 VDC.

WARNING

There are very high voltages present on the EVM. Some components will reach temperatures above 50°C. Precautions must be taken when handling the board. Never operate the UCC28019AEVM without the fan running. Always make certain the bulk capacitors have completely discharged prior to handling the EVM.

1. Working at an ESD workstation, make sure that the ionizer is on before the EVM is removed from the protective packaging and power is applied. Electrostatic smock and safety glasses should also be worn. Because voltages in excess of 400 V may be present on the EVM, do not connect the ground strap from the smock to the bench.
2. Power-UP
 - a. Connect the equipment as shown in [Figure 2](#).
 - b. Turn on the fan.
 - c. Prior to turning on the ac source, limit the source current to 8 A and then turn on the ac source.
 - d. Turn on the 12-V bias supply and verify that the output is within regulation.
 - e. Increase the load from 0 A up to 0.9 A.
 - f. The DRAIN, SOURCE, GATE, SWITCH node, RETURN, and VOUT+ are labeled on the surface mount side of the board for user access.
3. Power-Down
 - a. Turn off ac source.
 - b. Turn off bias supply.
 - c. Discharge the output capacitor.
 - d. Turn off the load.

8 UCC28019AEVM Performance Data and Characteristic Curves

The vertical lines on the following figures represent 20%, 50% and 100% load.

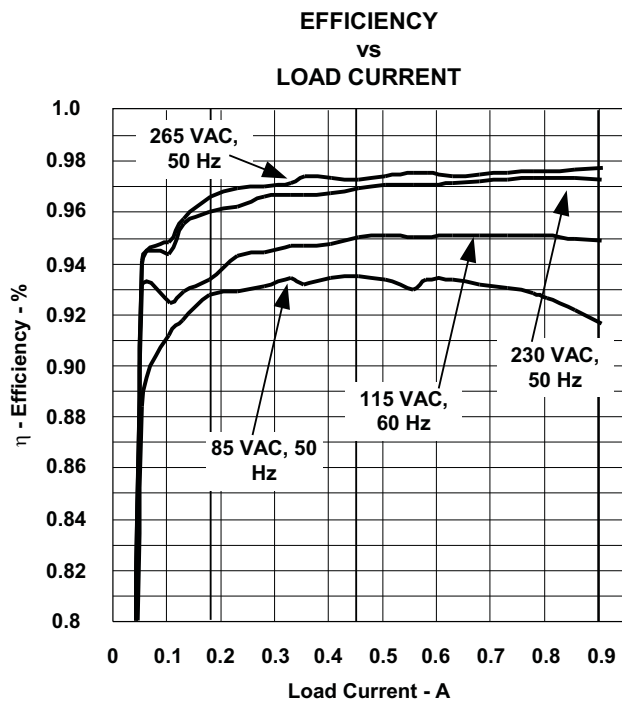

Figure 3. Efficiency as a Function of Line Voltage and Load Current

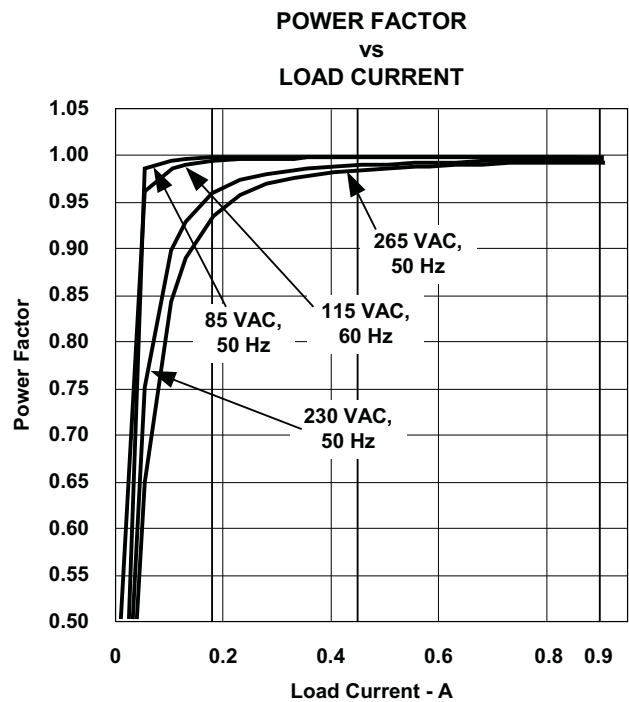

Figure 4. Power Factor as a Function of Line Voltage and Load Current

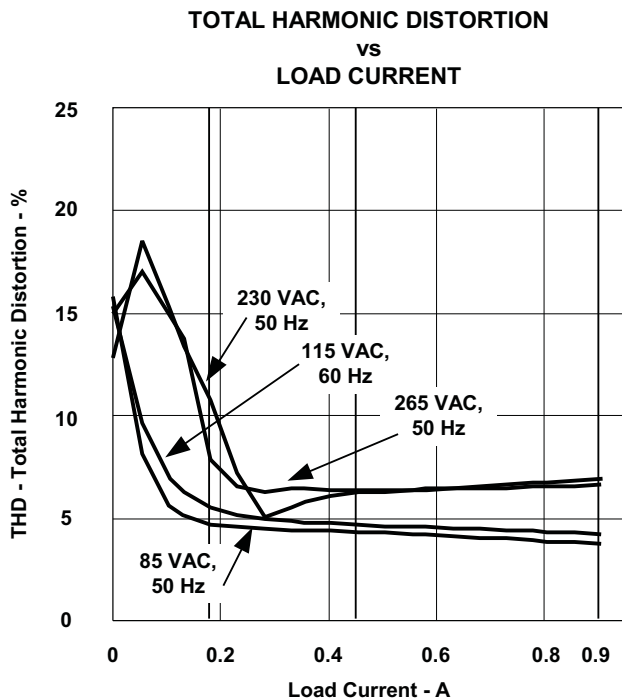

Figure 5. Total Harmonic Distortion as a Function of Line Voltage and Load Current

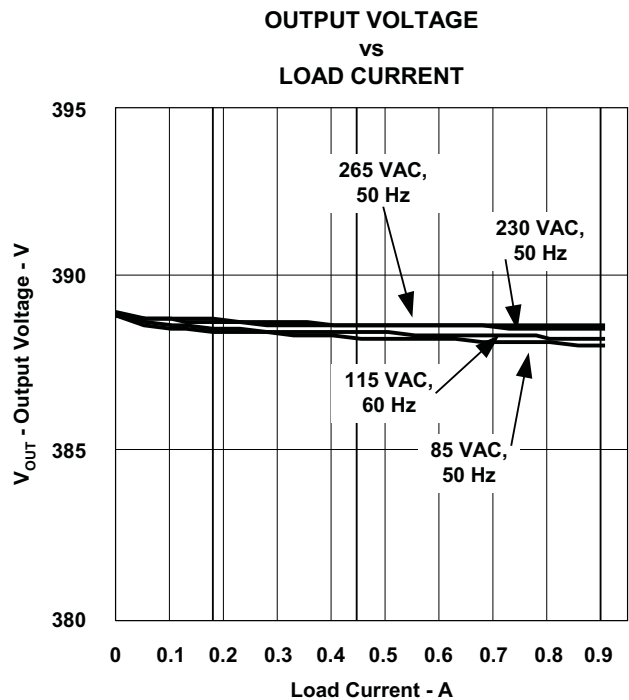

Figure 6. Output Voltage as a Function of Line Voltage and Load Current

CURRENT HARMONICS

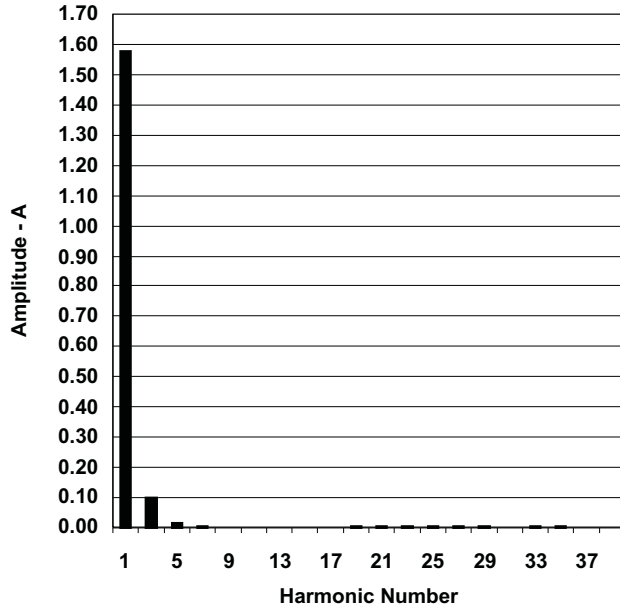

Figure 7. Current Harmonics, 230 VAC, 50 Hz input, Full Load

CURRENT HARMONICS
(230 VDC, 50 Hz full load)

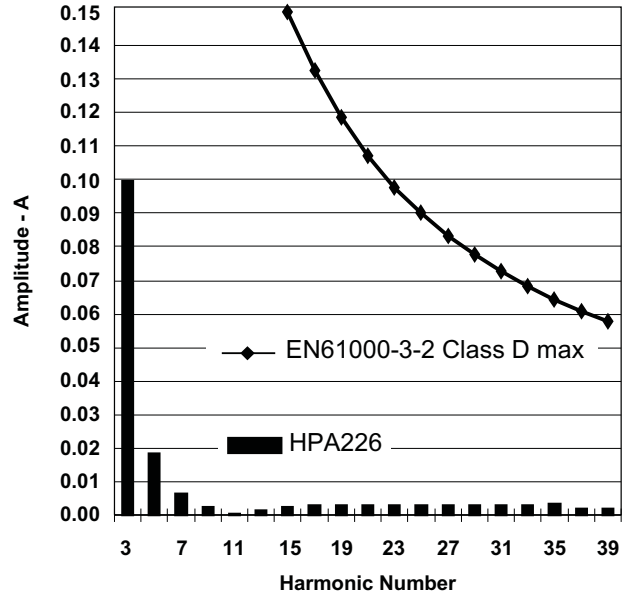

Figure 8. Current Harmonics, 230 VAC, 50 Hz Input, Full Load, Re-Scaled Without the Fundamental

INPUT VOLTAGE/CURRENT
vs
TIME

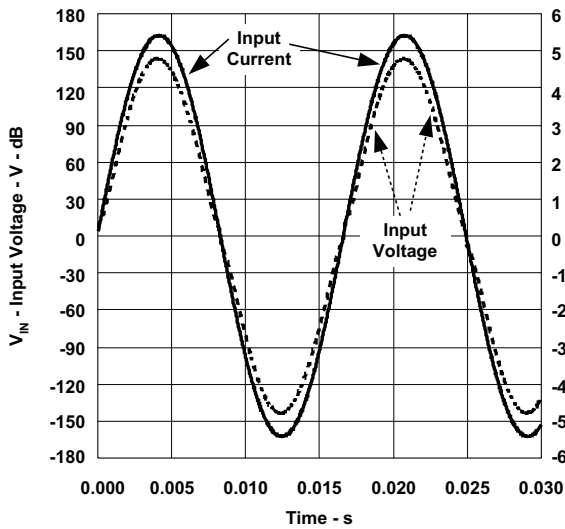

Figure 9. Input Voltage and Current Waveforms, 115 VAC, 60 Hz, Full Load

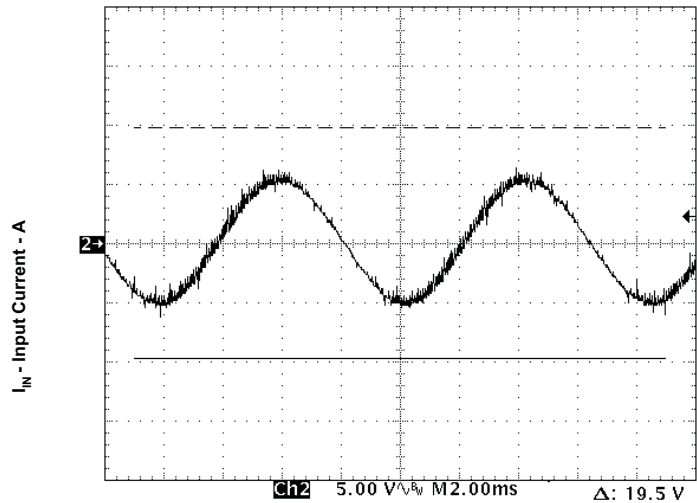

Figure 10. Line Frequency Output Voltage Ripple, 115 VAC, 60 Hz Input, Full Load

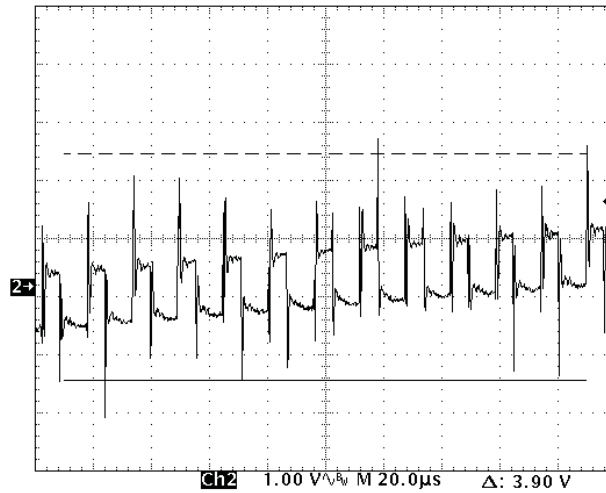

Figure 11. Switching Frequency Output Voltage Ripple, 115 VAC, 60 Hz Input, Full Load

The following figure shows the start-up waveform of the UCC28019AEVM as the 12-V bias supply is turned on. Note the constant $30\ \mu\text{A}$ of source current from VCOMP into the compensation capacitor which allows a linear voltage rise enabling a controlled increase of the input current until the output voltage reaches 95% of its regulated output voltage (370.5 VDC).

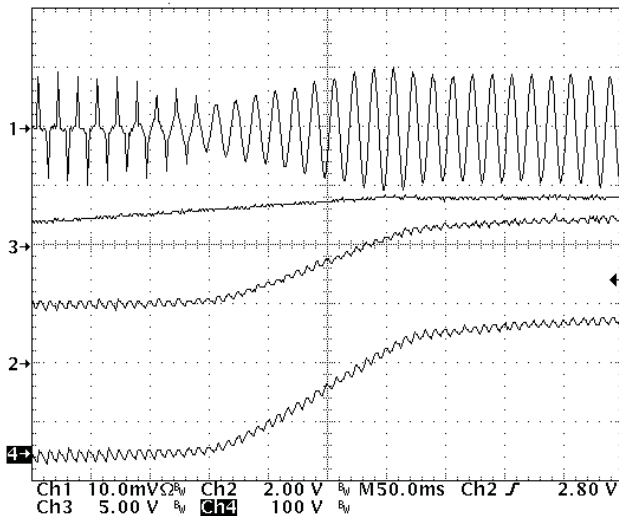

Figure 12. Start-Up Waveform (115 VAC, 60 Hz, 0.45 A load. Ch1 = I_{IN} @ 5 A/div, Ch.2 = VCOMP @ 2 V/div, Ch. 3 = VSENSE @ 5 V/div, Ch. 4 = VOUT @ 100 V/div offset by 155 VDC)

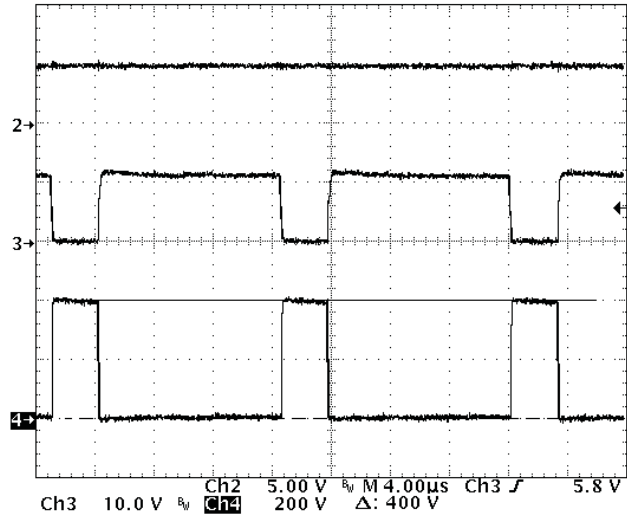

Figure 13. Switching Waveform (115 VAC, 60 Hz, full load. Ch. 2 = VCOMP @ 5 V/div, Ch. 3 = GATE @ 10 V/div, Ch. 4 = DRAIN @ 200 V/div.)

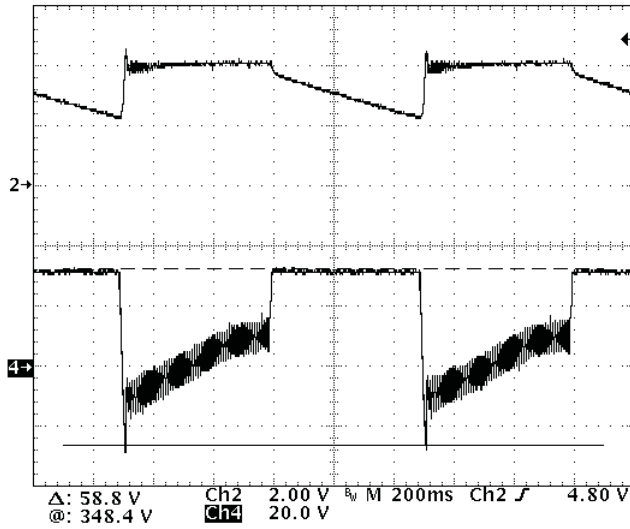

Figure 14. Load Transient (Load step: 0% to 100%. Ch. 2 = V_{COMP} @ 2 V/div., Ch. 4 = V_{OUT} @ 10 V/div. offset by 375 VDC)

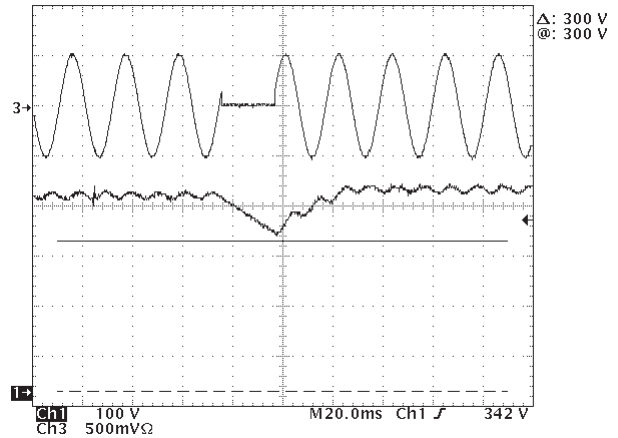

Figure 15. Line Drop Out, V_{IN} = 85 VAC, 50 Hz, Full Load (Ch. 3 = V_{IN} @ 500 mV X 200 V/div; measured with a differential probe, Ch. 1 = V_{OUT} @ 100 V/div. Drop out was one line cycle)

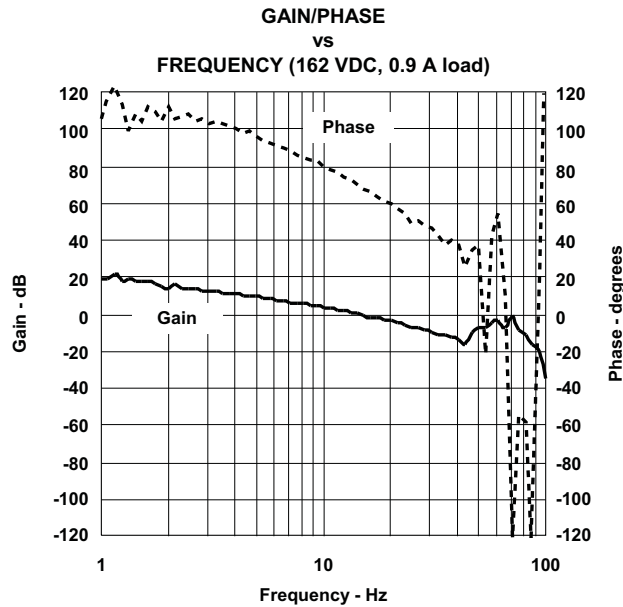

Figure 16. Bode Plot (162 VDC input, full load. Crossover frequency = 13 Hz, phase margin = 68°)

9 Board Layout Diagrams

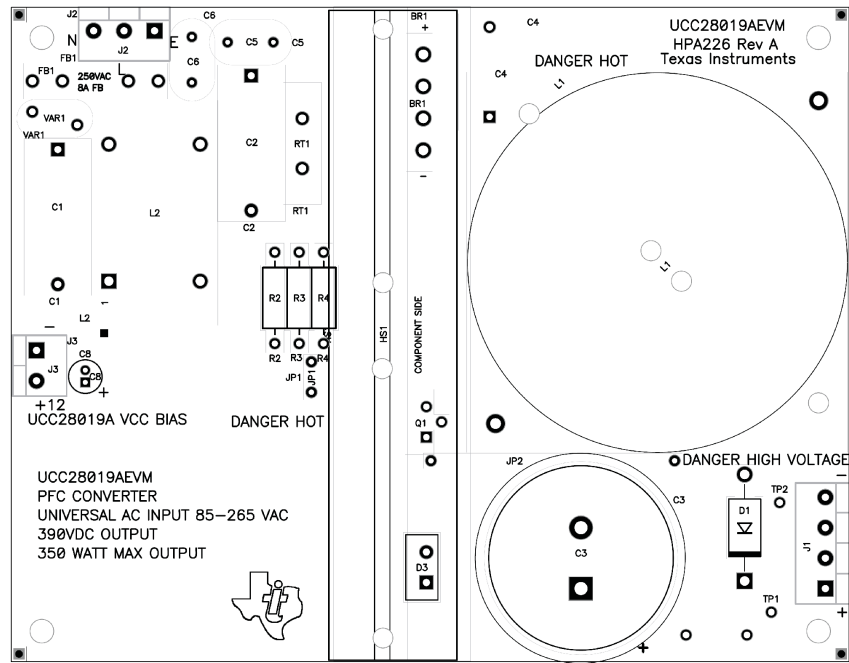

Figure 17. Top layer Component Placement

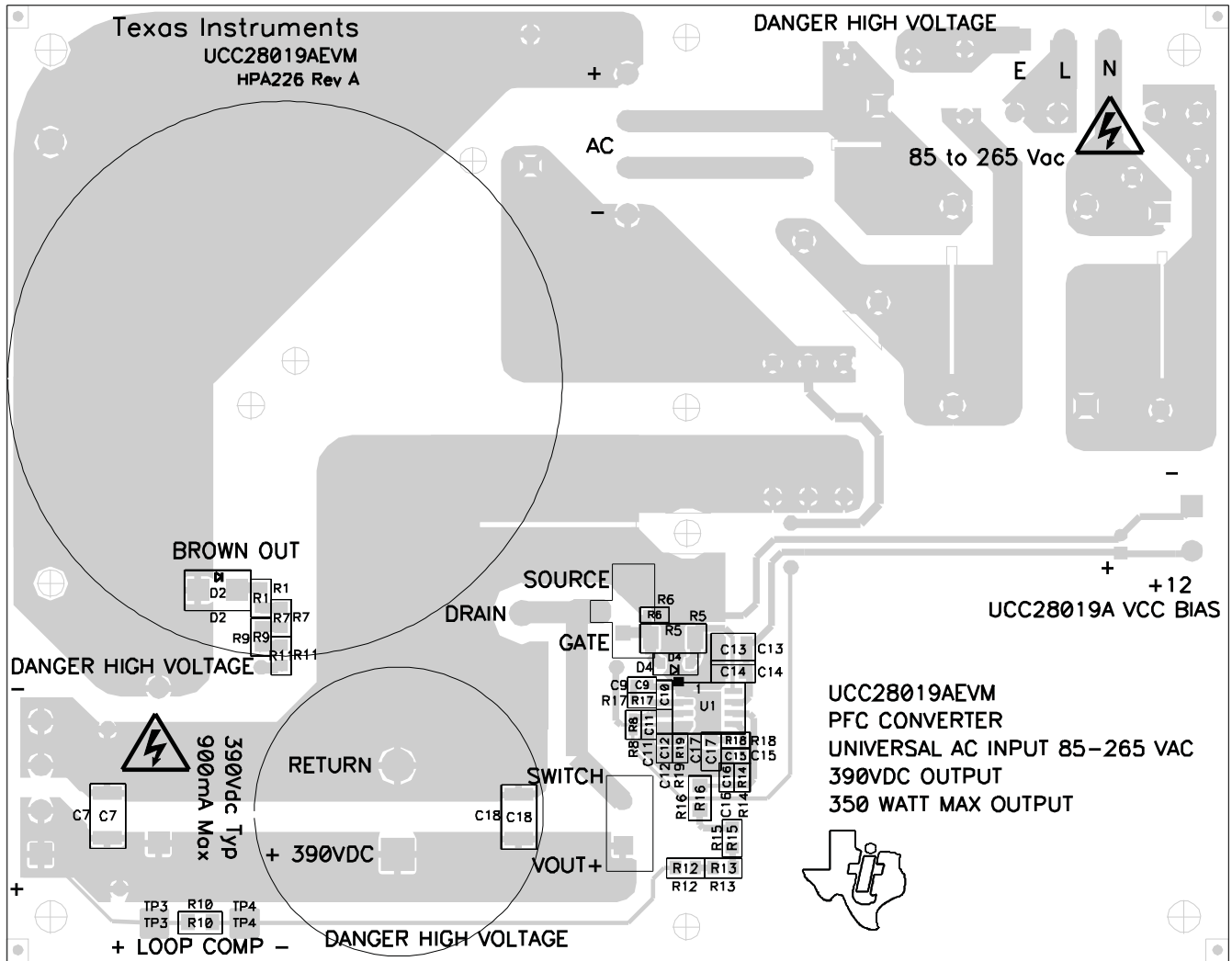

Figure 18. Bottom Layer

10 List of Materials

Table 2. List of Materials

REF DES	COUNT	DESCRIPTION	MFR	PART NUMBER
BR1	1	Diode, bridge rectifier, 8 A, 400 V, 0.880 x 0.140 inch	Diode Inc.	GBU804
C1, C2	2	Capacitor, film, 0.47 μ F, X2, 275 VAC, \pm 20%, 0.236 X 0.591 inch	Panasonic	ECQ-U2A474MG
C3	1	Capacitor, aluminum, 270 μ F, 450 VDC, \pm 20%, 30 x 30 mm	Panasonic	EETUQ2W271DA
C4	1	Capacitor, film, 0.33 μ F, X2, 275 VAC, \pm 20%, 0.690 x 0.374 inch	Panasonic	ECQ-U2A334ML
C5, C6	2	Capacitor, ceramic disc, 2200 pF, Y2, 250V, \pm 20%, 0.276 x 0.413 inch	TDK Corporation	CS11-E2GA222MYNS
C7, C18	2	Capacitor, ceramic, 0.1 μ F, 630V, X7R, \pm 10%, 1812	Std	Std
C8	1	Capacitor, aluminum, 47 μ F, 35 V, \pm 20%, 0.200 x 0.435 inch	Panasonic	ECA-1VM470
C9	0	Capacitor, ceramic, not populated, 50 V, X7R, \pm 10%, 0603	Std	not populated
C10	1	Capacitor, ceramic, 1200 pF, 50 V, X7R, \pm 10%, 0603	Std	Std
C11	1	Capacitor, ceramic, 1000 pF, 100 V, X7R, \pm 10%, 0603	Std	Std
C12	1	Capacitor, ceramic, 0.68 μ F, 10 V, X5R, \pm 10%, 0603	Std	Std
C13	1	Capacitor, ceramic, 1 μ F, 50 V, X7R, \pm 10%, 1210	Std	Std
C14	1	Capacitor, ceramic, 0.1 μ F, 50 V, X7R, \pm 10%, 1206	Std	Std
C15	1	Capacitor, ceramic, 0.22 μ F, 16 V, X7R, \pm 10%, 0603	Std	Std
C16	1	Capacitor, ceramic, 820 pF, 50 V, X7R, \pm 10%, 0603	Std	Std
C17	1	Capacitor, ceramic, 3.3 μ F, 10 V, X5R, \pm 10%, 0805	Std	Std
D1	1	Diode, standard recovery, 3 A, 600 V, DO-201AD	Micro Commercial Co.	1N5406-TP
D2	1	Diode, fast recovery, 1000 V, 1 A, SMB	Diodes Inc.	RS1MB-13-F
D3	1	Diode, silicon carbide Schottky diode, 4 A, 600 V, TO220AC	Cree	CSD04060A
D4	1	Diode, Schottky, 1 A, 40 V, SOD123	Micro Commercial Co.	MBRX140-TP
L1	1	Inductor, PFC boost, 1.25 mH, 7A, 2.50 inch dia.	Vitec	55P9354
L2	1	Inductor, 2 mH, 7.5 A, 22 m Ω , 0.800 x 1.450 inch	Vitec	54P2917
Q1	1	MOSFET, N-channel, 650 V, 20.7 A, 190 m Ω , TO-220V	Infineon Technologies	SPP20N60C3
R1, R7, R9	3	Resistor, chip, 1.80 M Ω , 1/10 W, \pm 1%, 0805	Std	Std
R2, R3, R4	3	Resistor, metal oxide, 0.2 Ω , 1 W, \pm 5%, 1 Watt	RCD Components	RSF1A-R20-JTW
R5	1	Resistor, chip, 3.3 Ω , 1/2 W, \pm 5%, 2010	Std	Std
R6	1	Resistor, chip, 10.0 k Ω , 1/16 W, \pm 1%, 0603	Std	Std
R8	1	Resistor, chip, 221 Ω , 1/16 W, \pm 1%, 0603	Std	Std
R10	1	Resistor, chip, 49.9 Ω , 1/4 W, \pm 1%, 1206	Std	Std
R11	1	Resistor, chip, 1.10 M Ω , 1/10 W, \pm 1%, 0805	Std	Std
R12, R13	2	Resistor, chip, 332 k Ω , 1/8 W, 150 V, \pm 1%, 0805	Std	Std
R14	1	Resistor, chip, 13.0 k Ω , 1/10 W, \pm 1%, 0603	Std	Std
R15	1	Resistor, chip, 340 k Ω , 1/8 W, 150 V, \pm 1%, 0805	Std	Std

Table 2. List of Materials (continued)

REF DES	COUNT	DESCRIPTION	MFR	PART NUMBER
R16	1	Resistor, metal film, 0 Ω , 1/4 W, $\pm 5\%$, 1210	Std	Std
R17	0	Resistor, chip, not populated, 1/10 W, $\pm 1\%$, 0603	Std	not populated
R18	1	Resistor, chip, 33.2 k Ω , 1/10 W, $\pm 1\%$, 0603	Std	Std
R19	1	Resistor, chip, 100 k Ω , 1/10 W, $\pm 1\%$, 0603	Std	Std
RT1	1	Thermistor, NTC, 5 Ω , 6 A, 0.220 X 0.770 inch	GE	CL-40
U1	1	Continuous Current Mode PFC Controller, SO8	Texas Instruments	UCC28019AD
VAR1	1	Varistor, 430 V, clamping max., 710 V, 25 A, 0.472 x 0.213 inch	GE	S10K275E2
F1	1	Fuse, fast acting, 8 A, 250 V, 1.400x 0.250 inch	Std	Std
HS1	1	Heatsink, vertical-mount, 782653B04250, 4.25 inches	Aavid Thermalloy	782653B04250

11 7. References

1. [UCC28019A 8-Pin Continuous Conduction Mode \(CCM\) PFC Controller data sheet, TI Literature number SLUS828](#)

IMPORTANT NOTICE

Texas Instruments Incorporated and its subsidiaries (TI) reserve the right to make corrections, modifications, enhancements, improvements, and other changes to its products and services at any time and to discontinue any product or service without notice. Customers should obtain the latest relevant information before placing orders and should verify that such information is current and complete. All products are sold subject to TI's terms and conditions of sale supplied at the time of order acknowledgment.

TI warrants performance of its hardware products to the specifications applicable at the time of sale in accordance with TI's standard warranty. Testing and other quality control techniques are used to the extent TI deems necessary to support this warranty. Except where mandated by government requirements, testing of all parameters of each product is not necessarily performed.

TI assumes no liability for applications assistance or customer product design. Customers are responsible for their products and applications using TI components. To minimize the risks associated with customer products and applications, customers should provide adequate design and operating safeguards.

TI does not warrant or represent that any license, either express or implied, is granted under any TI patent right, copyright, mask work right, or other TI intellectual property right relating to any combination, machine, or process in which TI products or services are used. Information published by TI regarding third-party products or services does not constitute a license from TI to use such products or services or a warranty or endorsement thereof. Use of such information may require a license from a third party under the patents or other intellectual property of the third party, or a license from TI under the patents or other intellectual property of TI.

Reproduction of TI information in TI data books or data sheets is permissible only if reproduction is without alteration and is accompanied by all associated warranties, conditions, limitations, and notices. Reproduction of this information with alteration is an unfair and deceptive business practice. TI is not responsible or liable for such altered documentation. Information of third parties may be subject to additional restrictions.

Resale of TI products or services with statements different from or beyond the parameters stated by TI for that product or service voids all express and any implied warranties for the associated TI product or service and is an unfair and deceptive business practice. TI is not responsible or liable for any such statements.

TI products are not authorized for use in safety-critical applications (such as life support) where a failure of the TI product would reasonably be expected to cause severe personal injury or death, unless officers of the parties have executed an agreement specifically governing such use. Buyers represent that they have all necessary expertise in the safety and regulatory ramifications of their applications, and acknowledge and agree that they are solely responsible for all legal, regulatory and safety-related requirements concerning their products and any use of TI products in such safety-critical applications, notwithstanding any applications-related information or support that may be provided by TI. Further, Buyers must fully indemnify TI and its representatives against any damages arising out of the use of TI products in such safety-critical applications.

TI products are neither designed nor intended for use in military/aerospace applications or environments unless the TI products are specifically designated by TI as military-grade or "enhanced plastic." Only products designated by TI as military-grade meet military specifications. Buyers acknowledge and agree that any such use of TI products which TI has not designated as military-grade is solely at the Buyer's risk, and that they are solely responsible for compliance with all legal and regulatory requirements in connection with such use.

TI products are neither designed nor intended for use in automotive applications or environments unless the specific TI products are designated by TI as compliant with ISO/TS 16949 requirements. Buyers acknowledge and agree that, if they use any non-designated products in automotive applications, TI will not be responsible for any failure to meet such requirements.

Following are URLs where you can obtain information on other Texas Instruments products and application solutions:

Products

Amplifiers	amplifier.ti.com
Data Converters	dataconverter.ti.com
DLP® Products	www.dlp.com
DSP	dsp.ti.com
Clocks and Timers	www.ti.com/clocks
Interface	interface.ti.com
Logic	logic.ti.com
Power Mgmt	power.ti.com
Microcontrollers	microcontroller.ti.com
RFID	www.ti-rfid.com
RF/IF and ZigBee® Solutions	www.ti.com/lprf

Applications

Audio	www.ti.com/audio
Automotive	www.ti.com/automotive
Broadband	www.ti.com/broadband
Digital Control	www.ti.com/digitalcontrol
Medical	www.ti.com/medical
Military	www.ti.com/military
Optical Networking	www.ti.com/opticalnetwork
Security	www.ti.com/security
Telephony	www.ti.com/telephony
Video & Imaging	www.ti.com/video
Wireless	www.ti.com/wireless

Mailing Address: Texas Instruments, Post Office Box 655303, Dallas, Texas 75265
Copyright © 2009, Texas Instruments Incorporated