

ROV20, ROV20H, ROV20E

20mm Series Metal Oxide Varistors

www.tycopowercomponents.com

Document: SCD 25484
Status: Released
Rev. A June 30, 2003

GENERAL DESCRIPTION

The ROV20-XXX (**R**adial-leaded Metal **O**xide **V**aristor) products are 20mm radial leaded varistor devices suitable for protection of overvoltage transients.

ROV devices can provide protection for a wide variety of power systems against overvoltage faults such as lightning, power contact and power induction. Suitable for a broad range of applications including, but not limited to security, power supplies, surge strips, etc., the ROV device helps to protect valuable equipment from potential power surge damage by clamping high energy, short duration impulses. The ROV devices have high current handling and energy absorption capability and fast response times to help protect against transient faults.

FEATURES

- Radial leaded
- Broad Varistor voltage and V_{rms} range
 - Varistor voltage : 18V - 1800V
 - V_{rms} voltage : 11V - 1000V
- Three surge capability series
 - Standard series, High surge series, Extra high surge series
- Various lead types
 - Straight, Kinked, Other
- Various packaging options
 - Bulk, Tape & Reel, Ammo Pack
- Helps designers meet the following standards
 - UL, CSA, VDE
- Fast response time
- High current and energy absorption capability

APPLICATIONS

- Power supplies and power systems
- Line voltage
- Telecommunications systems
- Automotive systems
- Appliances

TYPICAL APPLICATION SCHEMATIC

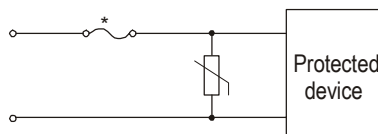

*In some applications, a polymeric PTC device such as a Tyco Electronics PolySwitch device may be used instead of a fuse to provide a preferred solution.

ROV20, ROV20H, ROV20E

20mm Series Metal Oxide Varistors

www.tycopowercomponents.com

Document: SCD 25484
Status: Released
Rev. A June 30, 2003

PART NUMBERING

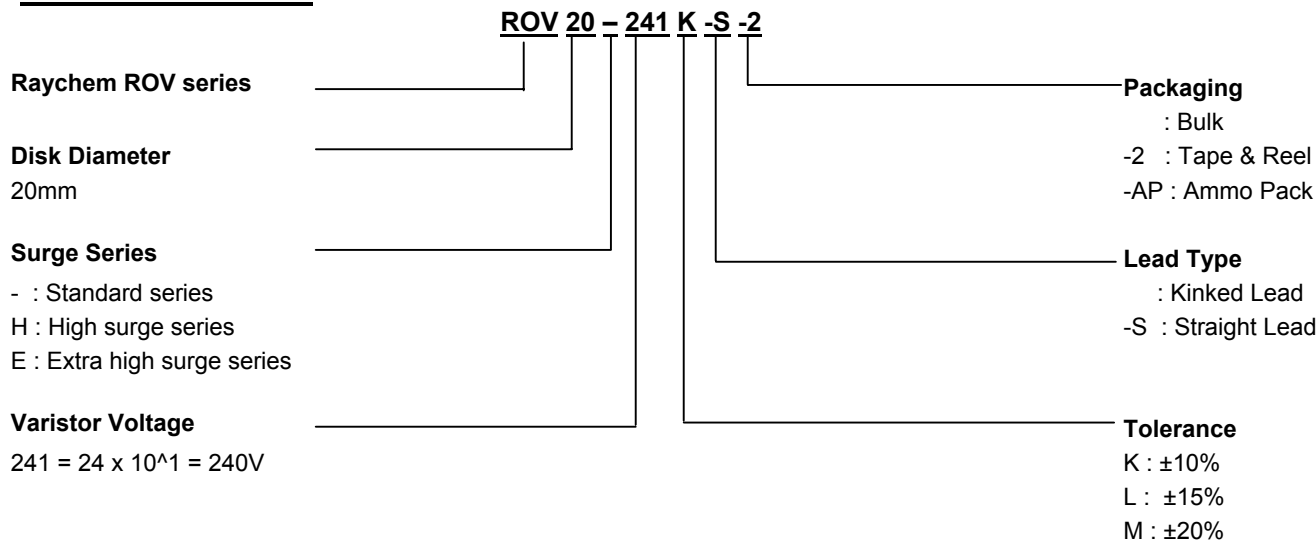

DEVICE MARKING

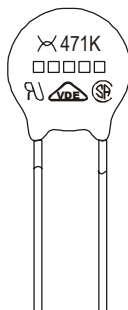
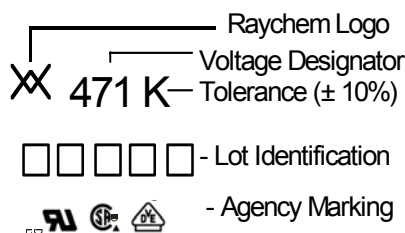

GENERAL CHARACTERISTICS

Storage temperature:	-40°C ... +125°C
Maximum operating temperature:	-40°C ... +125°C
Maximum working surface temperature:	+115°C
Temperature coefficient of voltage:	0 ... +0.05% / °C max.
Insulation resistance of coating (@ 500 V _{DC}):	Over 1000MΩ
Maximum response time:	25ns
Lead Material:	22AWG Sn/Pb Plated Copper

AGENCY RECOGNITION

Device Ratings and Characteristics Tables contain specific recognition information for each individual part. The table below details marking symbols for each agency recognition type.

UL1414	UL1449 (2nd Edition)	CSA	VDE
◆	●	▲	■

ROV20, ROV20H, ROV20E
20mm Series Metal Oxide Varistors

www.tycopowercomponents.com

Document: SCD 25484
Status: Released
Rev. A June 30, 2003

DEVICE RATINGS AND CHARACTERISTICS

STANDARD SERIES

Part Number	Varistor Voltage V@1.0mA		Maximum Allowable Voltage		Maximum Clamping Voltage V@100A	Maximum Surge Current (8x20us)		Rated Wattage	Energy (10x1000us)	Capacitance (Typical)	Certifications						
	(V _{DC})	Tolerance	V _{rms} (V _{AC})	(V _{DC})	(V _{DC})	1 Time (A)	2 Times (A)	(W)	(J)	@1kHz (pF)							
ROV20-180M	18	± 20%	11	14	36 ¹⁾	2000	1000	0.20	7.0	27100	● ■						
ROV20-220M	22		14	18	43 ¹⁾				8.0	21200	● ■						
ROV20-270M	27		17	22	53 ¹⁾				10.0	20000	● ■						
ROV20-330M	33		20	26	65 ¹⁾				12.0	17200	● ■						
ROV20-390L	39	± 15%	25	31	77 ¹⁾				6500	4000	1.00	14.0	15003	● ■			
ROV20-470L	47		30	38	93 ¹⁾							17.0	12080	● ■			
ROV20-560L	56		35	45	110 ¹⁾							20.0	11600	● ■			
ROV20-680L	68		40	56	135 ¹⁾							24.0	9600	● ■			
ROV20-820K	82	± 10%	50	65	135							6500	4000	1.00	44.0	5200	● ■
ROV20-101K	100		60	85	165										56.0	4000	● ■
ROV20-121K	120		75	100	200										64.0	3800	● ■
ROV20-151K	150		95	125	250										88.0	3000	● ■
ROV20-181K	180		115	150	300										104.0	2400	● ■
ROV20-201K	200		130	170	340										114.0	1829	◆ ● ▲ ■
ROV20-221K	220		140	180	360	124.0	1600	◆ ● ▲ ■									
ROV20-241K	240		150	200	395	134.0	1422	◆ ● ▲ ■									
ROV20-271K	270		175	225	455	158.0	1261	◆ ● ▲ ■									
ROV20-301K	300		195	250	505	168.0	1100	◆ ● ▲ ■									
ROV20-331K	330		210	275	550	184.0	1106	◆ ● ▲ ■									
ROV20-361K	360		230	300	595	208.0	987	◆ ● ▲ ■									
ROV20-391K	390		250	320	650	240.0	975	◆ ● ▲ ■									
ROV20-431K	430		275	350	710	264.0	858	◆ ● ▲ ■									
ROV20-471K	470	300	385	775	280.0	761	◆ ● ▲ ■										
ROV20-511K	510	320	418	842	296.0	792	◆ ● ▲ ■										
ROV20-561K	560	350	460	920	312.0	679	◆ ● ▲ ■										
ROV20-621K	620	385	505	1025	328.0	605	◆ ● ▲ ■										
ROV20-681K	680	420	560	1120	344.0	553	◆ ● ▲ ■										
ROV20-751K	750	460	615	1240	360.0	554	◆ ● ▲ ■										
ROV20-781K	780	485	640	1290	368.0	481	◆ ● ▲ ■										
ROV20-821K	820	510	670	1355	376.0	519	◆ ● ▲ ■										
ROV20-911K	910	550	745	1500	408.0	444	◆ ● ▲ ■										
ROV20-102K	1000	625	825	1650	448.0	400	◆ ● ▲ ■										
ROV20-112K	1100	680	895	1815	496.0	360	◆ ● ▲ ■										
ROV20-182K	1800	1000	1465	2970	695.0	260											

1) The clamping voltage for devices ROV20-180M to ROV20-680L is tested with 20A current.

ROV20, ROV20H, ROV20E
20mm Series Metal Oxide Varistors

www.tycopowercomponents.com

Document: SCD 25484
Status: Released
Rev. A June 30, 2003

PULSE LIFETIME RATING CURVES
STANDARD SERIES

V-I CHARACTERISTIC CURVES
STANDARD SERIES

ROV20-180M – ROV20-680K

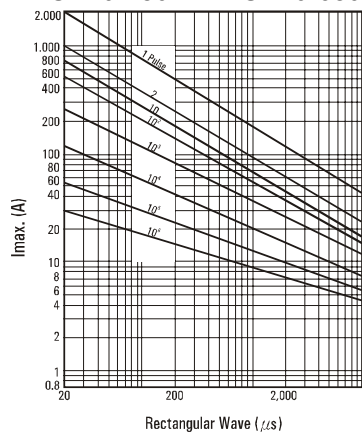

ROV20-180M – ROV20-680K

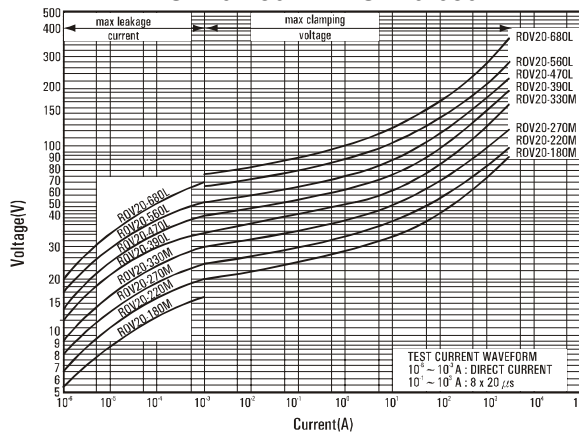

ROV20-820K – ROV20-511K

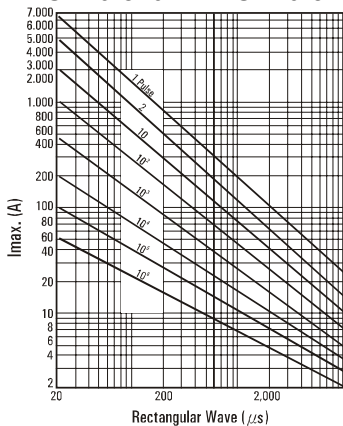

ROV20-820K – ROV20-511K

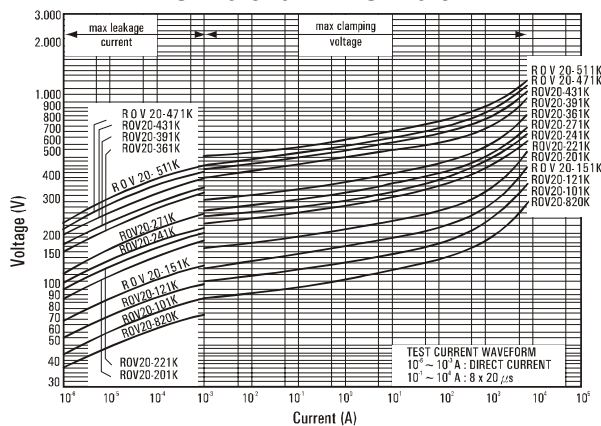

ROV20-561K – ROV20-182K

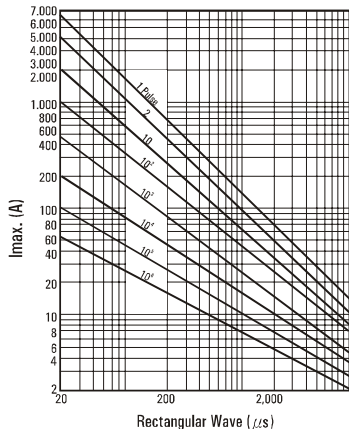

ROV20-561K – ROV20-182K

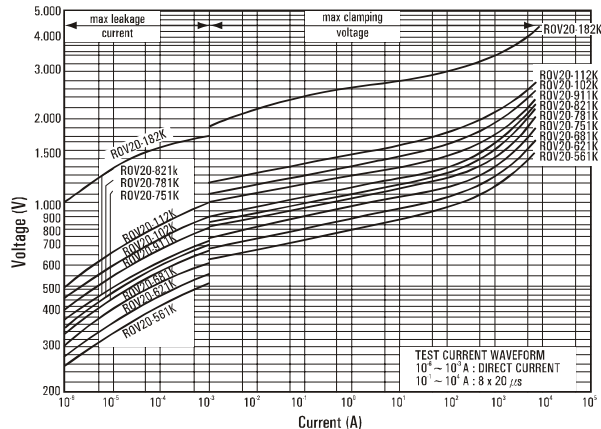

ROV20, ROV20H, ROV20E

20mm Series Metal Oxide Varistors

www.tycopowercomponents.com

Document: SCD 25484
Status: Released
Rev. A June 30, 2003

DEVICE RATINGS AND CHARACTERISTICS

HIGH SURGE SERIES

Part Number	Varistor Voltage V@1.0mA		Maximum Allowable Voltage		Maximum Clamping Voltage V@100A	Maximum Surge Current (8x20us)		Rated Wattage	Energy (10x1000us)	Capacitance (Typical)	Certifications
	(V _{DC})	Tolerance	V _{rms} (V _{AC})	(V _{DC})	(V _{DC})	1 Time (A)	2 Times (A)	(W)	(J)	@1kHz (pF)	
ROV20H180M	18	± 20%	11	14	36 ¹⁾	3000	2000	0.20	13.0	27100	● ■
ROV20H220M	22		14	18	43 ¹⁾				16.0	21200	● ■
ROV20H270M	27		17	22	53 ¹⁾				19.0	20000	● ■
ROV20H330M	33		20	26	65 ¹⁾				24.0	17200	● ■
ROV20H390L	39	± 15%	25	31	77 ¹⁾	3000	2000	0.20	28.0	15000	● ■
ROV20H470L	47		30	38	93 ¹⁾				34.0	12100	● ■
ROV20H560L	56		35	45	110 ¹⁾				41.0	11600	● ■
ROV20H680L	68		40	56	135 ¹⁾				49.0	9600	● ■
ROV20H820K	82	± 10%	50	65	135	10000	6500	1.00	56.0	5200	● ■
ROV20H101K	100		60	85	165				72.0	4000	● ■
ROV20H121K	120		75	100	200				88.0	3800	● ■
ROV20H151K	150		95	125	250				106.0	3000	● ■
ROV20H181K	180		115	150	300				130.0	2400	● ■
ROV20H201K	200		130	170	340				140.0	1830	◆ ● ▲ ■
ROV20H221K	220		140	180	360				155.0	1600	◆ ● ▲ ■
ROV20H241K	240		150	200	395				168.0	1420	◆ ● ▲ ■
ROV20H271K	270		175	225	455				190.0	1260	◆ ● ▲ ■
ROV20H301K	300		195	250	505				210.0	1100	◆ ● ▲ ■
ROV20H331K	330		210	275	550				228.0	1110	◆ ● ▲ ■
ROV20H361K	360		230	300	595				255.0	990	◆ ● ▲ ■
ROV20H391K	390		250	320	650				275.0	980	◆ ● ▲ ■
ROV20H431K	430		275	350	710				303.0	860	◆ ● ▲ ■
ROV20H471K	470		300	385	775				350.0	760	◆ ● ▲ ■
ROV20H511K	510		320	418	842				382.0	790	◆ ● ▲ ■
ROV20H561K	560	350	460	920	410.0	680	◆ ● ▲ ■				
ROV20H621K	620	385	505	1025	420.0	600	◆ ● ▲ ■				
ROV20H681K	680	420	560	1120	430.0	550	◆ ● ▲ ■				
ROV20H751K	750	460	615	1240	440.0	550	◆ ● ▲ ■				
ROV20H781K	780	485	640	1290	450.0	480	◆ ● ▲ ■				
ROV20H821K	820	510	670	1355	460.0	520	◆ ● ▲ ■				
ROV20H911K	910	550	745	1500	510.0	440	◆ ● ▲ ■				
ROV20H102K	1000	625	825	1650	566.0	400	◆ ● ▲ ■				
ROV20H112K	1100	680	895	1815	620.0	360	◆ ● ▲ ■				

1) The clamping voltage for devices ROV20H180M to ROV20H680L is tested with 20A current.

ROV20, ROV20H, ROV20E
20mm Series Metal Oxide Varistors

www.tycopowercomponents.com

Document: SCD 25484
Status: Released
Rev. A June 30, 2003

PULSE LIFETIME RATING CURVES
HIGH SURGE SERIES

V-I CHARACTERISTIC CURVES
HIGH SURGE SERIES

ROV20H180M – ROV20H680K

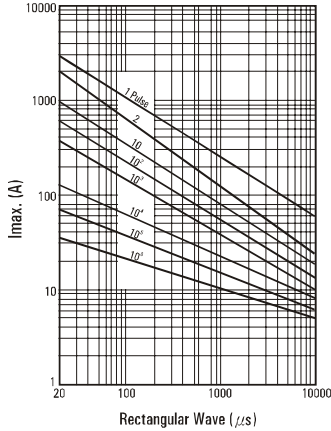

ROV20H180M – ROV20H680K

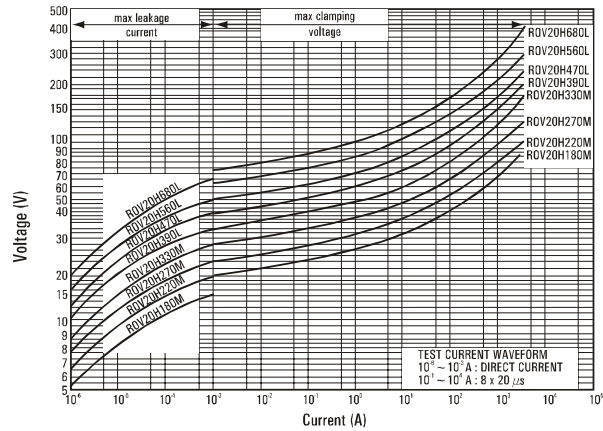

ROV20H820K – ROV20H511K

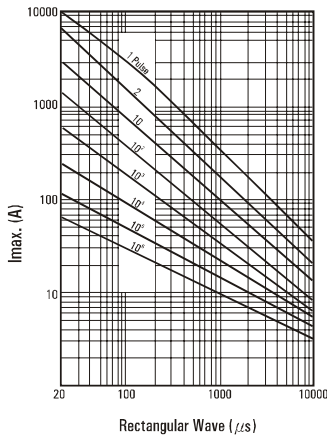

ROV20H820K – ROV20H511K

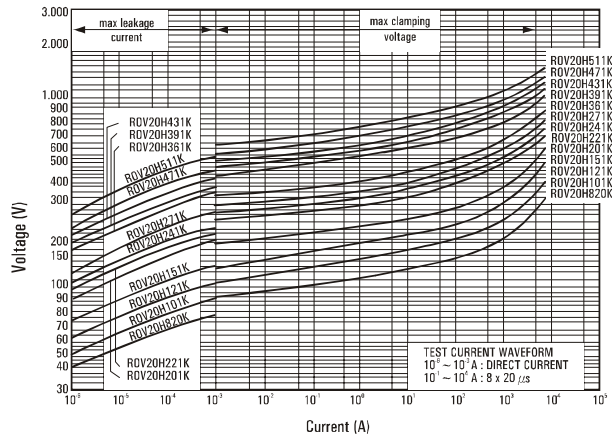

ROV20H561K – ROV20H182K

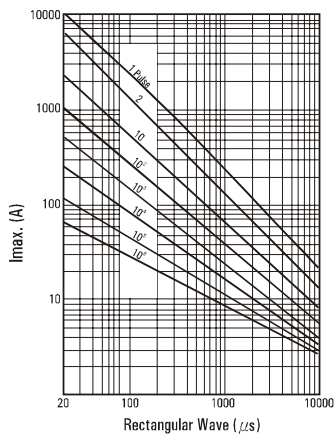

ROV20H561K – ROV20H182K

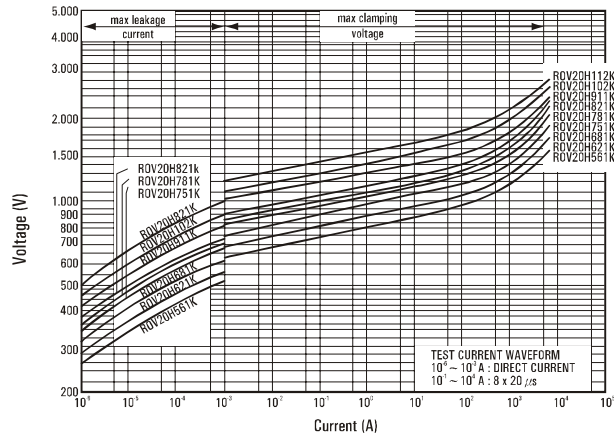

ROV20, ROV20H, ROV20E
20mm Series Metal Oxide Varistors

www.tycopowercomponents.com

Document: SCD 25484
Status: Released
Rev. A June 30, 2003

DEVICE RATINGS AND CHARACTERISTICS

EXTRA HIGH SURGE SERIES

Part Number	Varistor Voltage V@1.0mA		Maximum Allowable Voltage		Maximum Clamping Voltage V@100A	Maximum Surge Current (8x20us)		Rated Wattage	Energy (10x1000us)	Capacitance (Typical)	Certifications
	(V _{DC})	Tolerance	V _{rms} (V _{AC})	(V _{DC})	(V _{DC})	1 Time (A)	2 Times (A)	(W)	(J)	@1kHz (pF)	
ROV20E201K	200	± 10%	130	170	340	12500	10000	1.00	168.0	1830	● ▲
ROV20E221K	220		140	180	360				186.0	1600	● ▲
ROV20E241K	240		150	200	395				202.0	1420	● ▲
ROV20E271K	270		175	225	455				227.0	-----	
ROV20E301K	300		195	250	505				252.0	-----	
ROV20E331K	330		210	275	550				277.0	-----	
ROV20E361K	360		230	300	595				302.0	-----	

ROV20, ROV20H, ROV20E
20mm Series Metal Oxide Varistors

www.tycopowercomponents.com

Document: SCD 25484
Status: Released
Rev. A June 30, 2003

DIMENSIONS

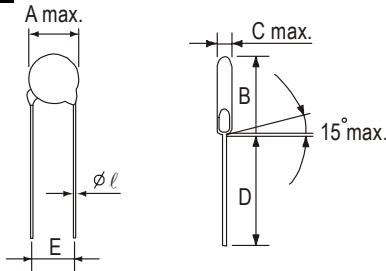

KINKED LEAD TYPE
Dimension Table

A max.	23.0
$\ell \pm 0.05$	1.0
$E \pm 1.0$	10.0
B max.	28.0
D_1 min.	25.0
D min.	24.0

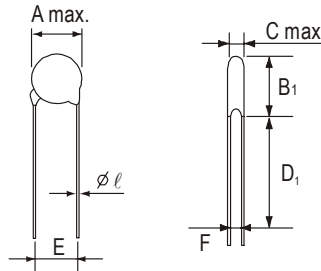

STRAIGHT LEAD TYPE (-S)
Table of C max., F, and B₁ max.

Type No.	C max.	F ± 0.8	B ₁ max.
180M	5.2	0.9	26.5
220L	5.3	1.0	26.5
270K	5.4	1.1	26.5
330K	5.4	1.2	26.5
390K	5.4	1.4	26.5
470K	5.6	1.4	26.5
560K	5.6	1.6	26.5
680K	6.1	1.9	26.5
820K	4.9	1.2	26.5
101K	5.1	1.2	26.5
121K	5.3	1.3	26.5
151K	5.6	1.6	26.5
181K	5.2	1.4	26.5
201K	5.3	1.4	26.5
221K	5.4	1.5	26.5
241K	5.5	1.7	26.5
271K	5.7	1.9	26.5
301K	5.9	2.1	26.5
331K	6.0	2.1	26.5
361K	6.2	2.3	26.5
391K	6.4	2.4	26.5
431K	7.2	2.7	26.5
471K	7.5	2.9	27.0
511K	7.7	3.3	27.0
561K	8.0	3.6	27.0
621K	8.3	4.1	27.0
681K	8.7	4.4	27.0
751K	9.1	4.5	27.0
781K	9.3	4.8	27.0
821K	9.5	4.8	27.0
911K	10.1	5.7	27.0
102K	10.7	5.8	27.0
112K	11.2	6.3	27.0
182K	13.5	10.4	29.0

ROV20, ROV20H, ROV20E

20mm Series Metal Oxide Varistors

www.tycopowercomponents.com

Document: SCD 25484
Status: Released
Rev. A June 30, 2003

PACKAGING

in mm

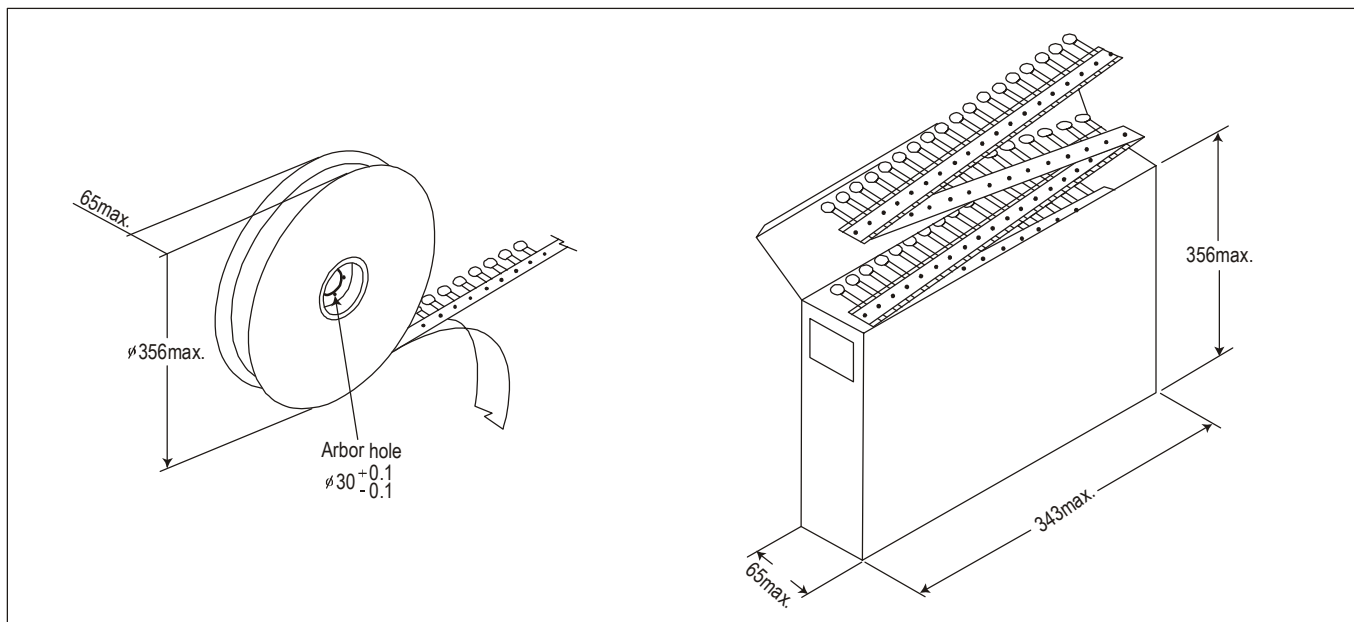

Packaging	Bulk (box)	Reel	Ammo
Box size (mm)	290 x 155 x 110	350 x 350 x 74	350 x 260 x 65
Carton size (mm)	310 x 328 x 250	370 x 370 x 468	365 x 535 x 275
One carton with	4 Boxes	6 Boxes (6 reels)	8 Boxes

Part Number	Bulk (box)	Reel	Ammo
ROV20-180M to ROV20-470K ROV20H180M to ROV20H470K	750	500	500
ROV20-560K to ROV20-680K, ROV20H560K to ROV20H680K	750	500	500
ROV20-820K to ROV20-331K, ROV20H820K to ROV20H331K	750	500	500
ROV20-361K to ROV20-391K, ROV20H361K to ROV20H391K	750	500	500
ROV20-431K to ROV20-471K, ROV20H431K to ROV20H471K	750	500	500
ROV20-511K to ROV20-751K, ROV20H511K to ROV20H751K	450	500	500
ROV20-781K to ROV20-182K, ROV20H781K to ROV20H112K	450	500	500

ROV20, ROV20H, ROV20E
20mm Series Metal Oxide Varistors

www.tycopowercomponents.com

Document: SCD 25484
Status: Released
Rev. A June 30, 2003

TAPE AND REEL DIMENSIONS

1/2" Pitch

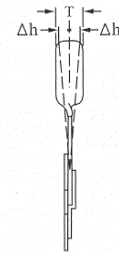
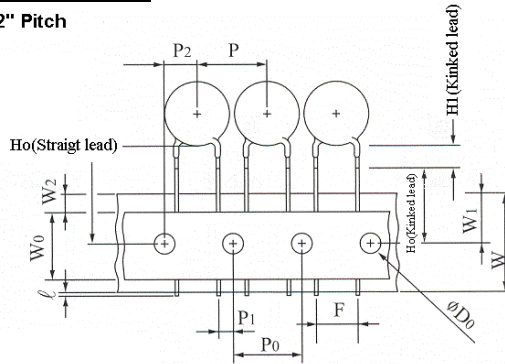

1.0" Pitch

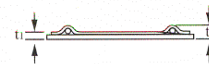
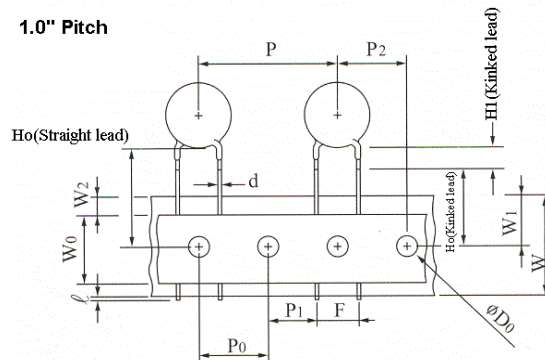

Symbols	Item	Value
l	Cut out length	1.1mm max.
H ₁ (Kinked type)	Height of kink	3.5mm max.
H ₀ (Kinked type)	Height to seating plane	16.0 ± 0.5mm
H ₀ (Straight type)	Height of component from hole center	16.0-21.0mm
Δh	Front to back deviation	0.0 ± 2.0mm
W	Carrier tape width	18.0 ^{+1.0} _{-0.5} mm
W ₀	Hold down tape width	12.0mm
W ₁	Sprocket hole position	9.0 ^{+0.75} _{-0.5} mm
W ₂	Adhesive tape position	3.0mm max.
F	Component lead spacing	10.0 ^{+0.8} _{-0.2} mm
P	Pitch of component	25.4 ± 1.0mm
P ₀	Sprocket hole pitch	12.7 ± 0.3mm
P ₁	Lead length from hole center to lead	7.7 ± 0.7mm, 8.95 ± 0.7mm
P ₂	Length from hole center to disk center	12.7 ± 1.3mm
D ₀	Sprocket hole diameter	4.0 ± 0.2mm
d	Lead wire diameter	0.8 ± 0.05mm, 1.0 ± 0.05mm
T	Disk thickness	See C. max table
t ₁	Total thickness tape	0.7 ± 0.05mm
t ₂	Total thickness	1.8mm max.



ROV20, ROV20H, ROV20E 20mm Series Metal Oxide Varistors

www.tycopowercomponents.com

Document: SCD 25484
Status: Released
Rev. A June 30, 2003

Information furnished is believed to be accurate and reliable. However, users should independently evaluate the suitability of each product for their applications. Tyco Electronics Corporation assumes no responsibility for the use of its product or for any infringement of patents or other rights of third parties resulting from the use of its product. No license is granted by implication or otherwise under any patent or proprietary right of Tyco Electronics except the right to use such product for the purpose for which it is sold. Tyco Electronics reserves the right to change or update, without notice, any information contained in this publication; to change, without notice, the design, construction, processing, or specification of any product; and to discontinue or limit production or distribution of any product. This publication supersedes and replaces all information previously supplied. Without express written consent by an officer of Tyco Electronics, Tyco Electronics does not authorize the use of any its products as components in nuclear facility applications, aerospace, or in critical life support devices or systems. Tyco Electronics' only obligations are those in the Tyco Electronics Standard Terms and Conditions of Sale and in no case will Tyco Electronics be liable for any incidental, indirect, or consequential damages arising from the sale, resale, use, or misuse of its products.

Raychem is a trademark of Tyco Electronics Corporation

© 2003 Tyco Electronics Corporation