

Model 23

4mm Square

Sealed Single Turn

Surface Mount

Cermet Trimming Potentiometer



ELECTRICAL

Standard Resistance Range	100 Ohms to 2 Megohms
Standard Resistance Tolerance	±20%
Input Voltage	200 Vdc Max. or rms not to exceed power rating
Power Rating	0.25 Watts at 70°C derating to 0 at 125°C
End Resistance	1% or 3 Ohms Max., whichever is greater
Actual Electrical Travel	200° nominal
Dielectric Strength	500 Vrms
Insulation Resistance	100 Megohms Min.
Resolution	Essentially infinite
Contact Resistance Variation	2% or 3 Ohms Max., whichever is greater

ENVIRONMENTAL

Seal	85°C Fluorinert® (No Leaks)
Temperature Coefficient	±100 ppm/°C (<200 Ohms or >1Meg = ±250 ppm/°C)
Operating Temperature Range	-55°C to +125°C
Thermal Shock	Five cycles -55°C to +125°C (2% ΔRT, 2% ΔVR)
Moisture Resistance	Ten 24 hour cycles (3% ΔRT)
Shock	6 ms sawtooth, 100 G's (1% ΔRT, 1% ΔVR)
Vibration	20 G's, 10 to 2,000 Hz (1% ΔRT, 1% ΔVR)
High Temperature Exposure	250 hours at 125°C (2% ΔRT, 2% ΔVR)
Rotational Life	100 cycles (5% ΔRT)
Load Life	1,000 hours at 70°C & 0.25 Watts (3% ΔRT, 1% ΔVR)
Resistance to Solder Heat	260°C for 10 sec. (1% ΔRT)

MECHANICAL

Mechanical Stops	Solid
Stop Strength	4 oz.-in. Min. (300 g-cm)
Torque	2 oz.-in. Max. (150 g-cm)
Weight	0.005 oz. nominal (0.14 grams)

*Specifications subject to change without notice.
Fluorinert® is a registered trademark of 3M Company.*

Model 23

STANDARD RESISTANCE VALUES

100	1K	10K	100K	1Meg
200	2K	20K	200K	2Meg
500	5K	50K	500K	

CIRCUIT DIAGRAM

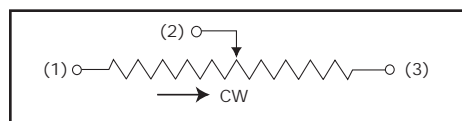

PACKAGING

Standard (no code): Boxes. Capacity = 100 units.

Option (TR code): Tape & Reel. All units oriented with #2 (slider) pin adjacent to sprocket holes.

	Pin Style	A,B	S
Tape	Width =	12 mm	12 mm
	Sprocket =	4 mm pitch	4 mm pitch
	Capacity =	500 units	750 units
Reel	Diameter =	7" (178 mm)	10" (254 mm)

ORDERING INFORMATION

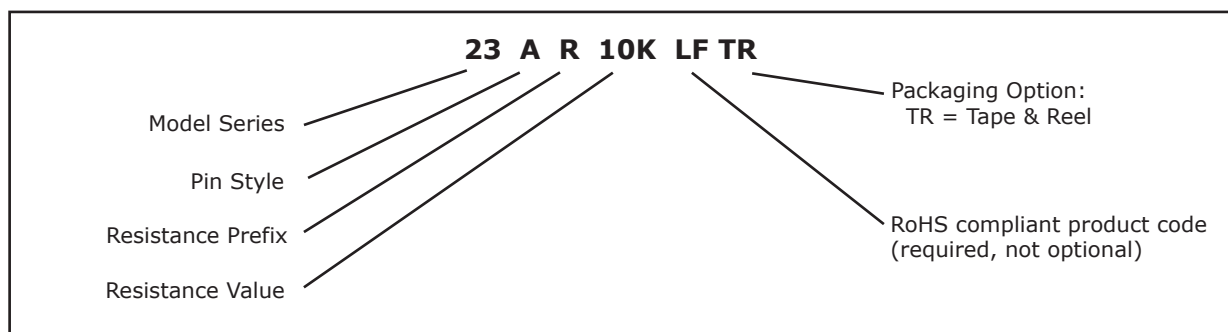

RECOMMENDED PCB LAYOUT

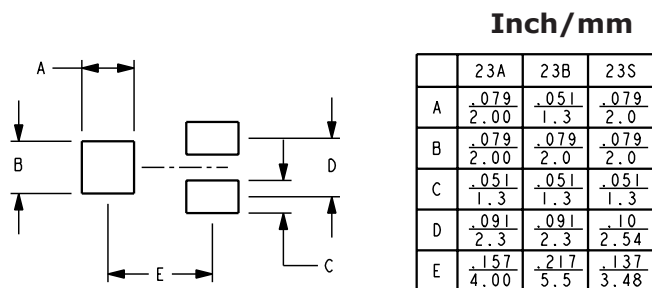

THROUGH HOLE

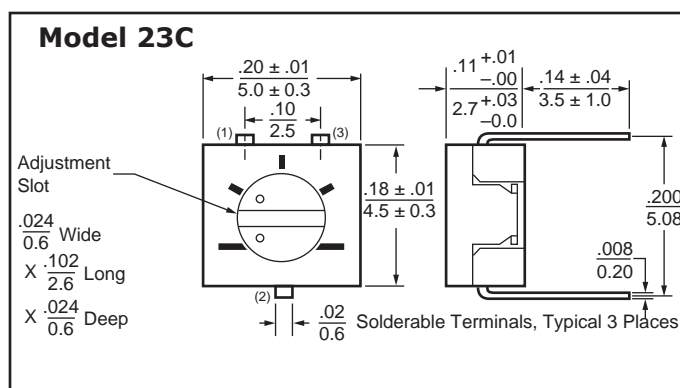

Model 23

TOP ADJUSTMENT

Model 23A - J Hook

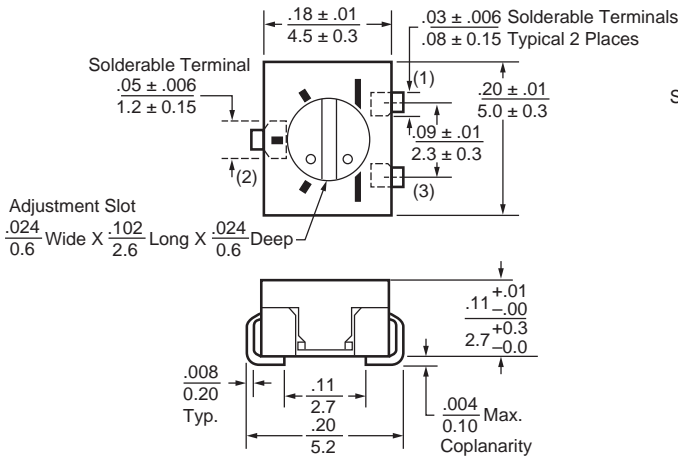

Model 23B - Gull Wing

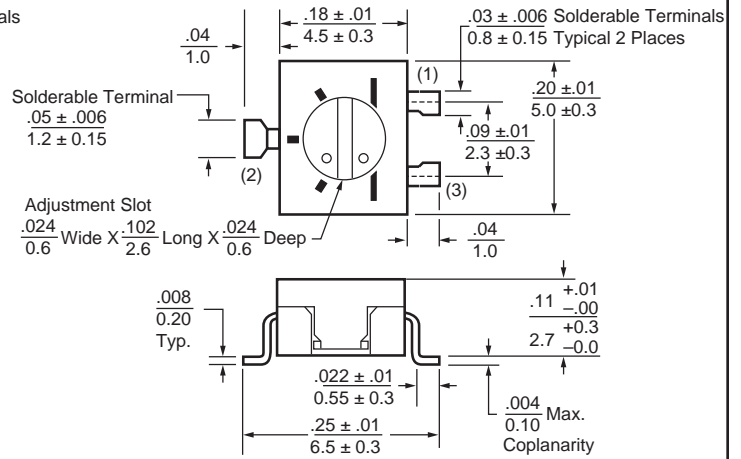

SIDE ADJUSTMENT

Model 23S

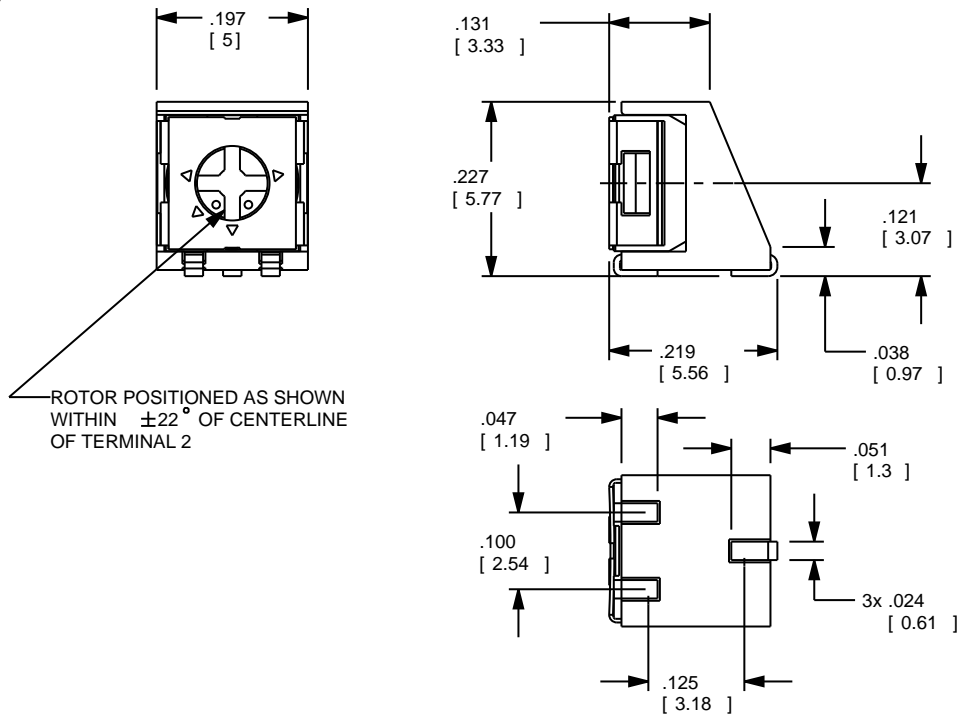

1. Dimensions in inch/mm
2. Tolerances ± 0.01 inch (0.3 mm) unless otherwise specified