



**MCP1630**  
**Input Boost Converter**  
**Demo Board**  
**User's Guide**

---

**Note the following details of the code protection feature on Microchip devices:**

- Microchip products meet the specification contained in their particular Microchip Data Sheet.
- Microchip believes that its family of products is one of the most secure families of its kind on the market today, when used in the intended manner and under normal conditions.
- There are dishonest and possibly illegal methods used to breach the code protection feature. All of these methods, to our knowledge, require using the Microchip products in a manner outside the operating specifications contained in Microchip's Data Sheets. Most likely, the person doing so is engaged in theft of intellectual property.
- Microchip is willing to work with the customer who is concerned about the integrity of their code.
- Neither Microchip nor any other semiconductor manufacturer can guarantee the security of their code. Code protection does not mean that we are guaranteeing the product as "unbreakable."

Code protection is constantly evolving. We at Microchip are committed to continuously improving the code protection features of our products. Attempts to break Microchip's code protection feature may be a violation of the Digital Millennium Copyright Act. If such acts allow unauthorized access to your software or other copyrighted work, you may have a right to sue for relief under that Act.

---

Information contained in this publication regarding device applications and the like is provided only for your convenience and may be superseded by updates. It is your responsibility to ensure that your application meets with your specifications. MICROCHIP MAKES NO REPRESENTATIONS OR WARRANTIES OF ANY KIND WHETHER EXPRESS OR IMPLIED, WRITTEN OR ORAL, STATUTORY OR OTHERWISE, RELATED TO THE INFORMATION, INCLUDING BUT NOT LIMITED TO ITS CONDITION, QUALITY, PERFORMANCE, MERCHANTABILITY OR FITNESS FOR PURPOSE. Microchip disclaims all liability arising from this information and its use. Use of Microchip devices in life support and/or safety applications is entirely at the buyer's risk, and the buyer agrees to defend, indemnify and hold harmless Microchip from any and all damages, claims, suits, or expenses resulting from such use. No licenses are conveyed, implicitly or otherwise, under any Microchip intellectual property rights.

**Trademarks**

The Microchip name and logo, the Microchip logo, Accuron, dsPIC, KEELOQ, KEELOQ logo, microID, MPLAB, PIC, PICmicro, PICSTART, PRO MATE, rfPIC and SmartShunt are registered trademarks of Microchip Technology Incorporated in the U.S.A. and other countries.

AmpLab, FilterLab, Linear Active Thermistor, Migratable Memory, MXDEV, MXLAB, SEEVAL, SmartSensor and The Embedded Control Solutions Company are registered trademarks of Microchip Technology Incorporated in the U.S.A.

Analog-for-the-Digital Age, Application Maestro, CodeGuard, dsPICDEM, dsPICDEM.net, dsPICworks, ECAN, ECONOMONITOR, FanSense, FlexROM, fuzzyLAB, In-Circuit Serial Programming, ICSP, ICEPIC, Mindi, MiWi, MPASM, MPLAB Certified logo, MPLIB, MPLINK, PICkit, PICDEM, PICDEM.net, PICLAB, PICtail, PowerCal, PowerInfo, PowerMate, PowerTool, REAL ICE, rFLAB, Select Mode, Smart Serial, SmartTel, Total Endurance, UNI/O, WiperLock and ZENA are trademarks of Microchip Technology Incorporated in the U.S.A. and other countries.

SQTP is a service mark of Microchip Technology Incorporated in the U.S.A.

All other trademarks mentioned herein are property of their respective companies.

© 2007, Microchip Technology Incorporated, Printed in the U.S.A., All Rights Reserved.

 Printed on recycled paper.

**QUALITY MANAGEMENT SYSTEM**  
**CERTIFIED BY DNV**  
**== ISO/TS 16949:2002 ==**

*Microchip received ISO/TS-16949:2002 certification for its worldwide headquarters, design and wafer fabrication facilities in Chandler and Tempe, Arizona; Gresham, Oregon and design centers in California and India. The Company's quality system processes and procedures are for its PIC® MCUs and dsPIC® DSCs, KEELOQ® code hopping devices, Serial EEPROMs, microperipherals, nonvolatile memory and analog products. In addition, Microchip's quality system for the design and manufacture of development systems is ISO 9001:2000 certified.*



# MCP1630 AUTOMOTIVE INPUT BOOST CONVERTER DEMO BOARD USER'S GUIDE

## Table of Contents

<b>Preface</b> .....	<b>1</b>
Introduction.....	1
Document Layout .....	1
Conventions Used in this Guide .....	2
Recommended Reading.....	2
The Microchip Web Site .....	3
Customer Support .....	3
Document Revision History .....	3
<b>Chapter 1. Product Overview</b>	
1.1 Introduction.....	5
1.2 What is the MCP1630 Automotive Input Boost Converter Demo Board? .....	6
1.3 What the MCP1630 Automotive Input Boost Converter Demo Board Kit Includes .....	6
<b>Chapter 2. Installation and Operation</b>	
2.1 Introduction.....	7
2.2 Features .....	7
2.3 Getting Started .....	8
<b>Appendix A. Schematic and Layouts</b>	
A.1 Introduction .....	11
A.2 Board – Schematic.....	12
A.3 Board – Top Silk Layer .....	13
A.4 Board – Top Metal Layer .....	14
A.5 Board – Bottom Metal Layer .....	15
<b>Appendix B. Bill Of Materials (BOM)</b>	
<b>Appendix C. Demo Board Firmware</b>	
C.1 Device Firmware.....	19
<b>Worldwide Sales and Service</b> .....	<b>20</b>

# **MCP1630 Automotive Input Boost Converter Demo Board User's Guide**

---

---

NOTES:



# MCP1630 AUTOMOTIVE INPUT BOOST CONVERTER DEMO BOARD USER'S GUIDE

## Preface

### NOTICE TO CUSTOMERS

All documentation becomes dated, and this manual is no exception. Microchip tools and documentation are constantly evolving to meet customer needs, so some actual dialogs and/or tool descriptions may differ from those in this document. Please refer to our web site ([www.microchip.com](http://www.microchip.com)) to obtain the latest documentation available.

Documents are identified with a “DS” number. This number is located on the bottom of each page, in front of the page number. The numbering convention for the DS number is “DSXXXXA”, where “XXXX” is the document number and “A” is the revision level of the document.

For the most up-to-date information on development tools, see the MPLAB® IDE on-line help. Select the Help menu, and then Topics to open a list of available on-line help files.

## INTRODUCTION

This chapter contains general information that will be useful to know before using the MCP1630 Automotive Input Boost Converter Demo Board. Items discussed in this chapter include:

- Document Layout
- Conventions Used in this Guide
- Recommended Reading
- The Microchip Web Site
- Customer Support
- Document Revision History

## DOCUMENT LAYOUT

This document describes how to use the MCP1630 Automotive Input Boost Converter Demo Board. The manual layout is as follows:

- **Chapter 1. “Product Overview”** – Important information about the MCP1630 Automotive Input Boost Converter Demo Board.
- **Chapter 2. “Installation and Operation”** – Includes instructions on how to get started with this user’s guide and a description of the user’s guide.
- **Appendix A. “Schematic and Layouts”** – Shows the schematic and layout diagrams for the MCP1630 Automotive Input Boost Converter Demo Board.
- **Appendix B. “Bill Of Materials (BOM)”** – Lists the parts used to build the MCP1630 Automotive Input Boost Converter Demo Board.
- **Appendix C. “Demo Board Firmware”** – Provides information about the application firmware and where the source code can be found.

## CONVENTIONS USED IN THIS GUIDE

This manual uses the following documentation conventions:

### DOCUMENTATION CONVENTIONS

Description	Represents	Examples
<b>Arial font:</b>		
Italic characters	Referenced books	<i>MPLAB<sup>®</sup> IDE User's Guide</i>
	Emphasized text	...is the <i>only</i> compiler...
Initial caps	A window	the Output window
	A dialog	the Settings dialog
	A menu selection	select Enable Programmer
Quotes	A field name in a window or dialog	"Save project before build"
Underlined, italic text with right angle bracket	A menu path	<u><i>File&gt;Save</i></u>
Bold characters	A dialog button	Click <b>OK</b>
	A tab	Click the <b>Power</b> tab
N'Rnnnn	A number in verilog format, where N is the total number of digits, R is the radix and n is a digit.	4'b0010, 2'hF1
Text in angle brackets < >	A key on the keyboard	Press <Enter>, <F1>
<b>Courier New font:</b>		
Plain Courier New	Sample source code	#define START
	Filenames	autoexec.bat
	File paths	c:\mcc18\h
	Keywords	_asm, _endasm, static
	Command-line options	-Opa+, -Opa-
	Bit values	0, 1
	Constants	0xFF, 'A'
Italic Courier New	A variable argument	<i>file.o</i> , where <i>file</i> can be any valid filename
Square brackets [ ]	Optional arguments	mcc18 [options] <i>file</i> [options]
Curly brackets and pipe character: {   }	Choice of mutually exclusive arguments; an OR selection	errorlevel {0 1}

## RECOMMENDED READING

This user's guide describes how to use MCP1630 Automotive Input Boost Converter Demo Board. The following Microchip documents are available and recommended as supplemental reference resources.

### **MCP1630/MCP1630V Data Sheet, "High-Speed, Microcontroller-Adaptable, Pulse Width Modulator" (DS21896)**

This data sheet provides detailed information regarding the MCP1630/MCP1630V product family.

### **PIC12F683 Data Sheet, "8-Pin Flash-Based, 8-Bit CMOS Microcontrollers with Nano Watt Technology" (DS41211)**

This data sheet provides detailed information regarding the PIC12F683 product family.

## THE MICROCHIP WEB SITE

Microchip provides online support via our web site at [www.microchip.com](http://www.microchip.com). This web site is used as a means to make files and information easily available to customers. Accessible by using your favorite Internet browser, the web site contains the following information:

- **Product Support** – Data sheets and errata, application notes and sample programs, design resources, user's guides and hardware support documents, latest software releases and archived software
- **General Technical Support** – Frequently Asked Questions (FAQs), technical support requests, online discussion groups, Microchip consultant program member listing
- **Business of Microchip** – Product selector and ordering guides, latest Microchip press releases, listing of seminars and events, listings of Microchip sales offices, distributors and factory representatives

## CUSTOMER SUPPORT

Users of Microchip products can receive assistance through several channels:

- Distributor or Representative
- Local Sales Office
- Field Application Engineer (FAE)
- Technical Support

Customers should contact their distributor, representative or field application engineer (FAE) for support. Local sales offices are also available to help customers. A listing of sales offices and locations is included in the back of this document.

Technical support is available through the web site at: <http://support.microchip.com>

## DOCUMENT REVISION HISTORY

### Revision B (June 2007)

- Updated Bill of Materials (BOM) for C12, C13, and L1
- Add disclaimer to Bill of Materials regarding RoHS-Compliant part numbers.

### Revision A (April 2006)

- Initial Release of this Document.

# **MCP1630 Automotive Input Boost Converter Demo Board User's Guide**

---

---

NOTES:



## Chapter 1. Product Overview

### 1.1 INTRODUCTION

The proliferation of distributed power supplies is expected to accelerate their use in future generation cars. Distributed power supplies or "point-of-load" power supplies are being used increasingly throughout. These Power Supply Units (PSUs) are responsible for stepping up (or down) a 12V nominal bus, to power a multitude of subsystems. These include telematics/navigation systems, power seats and doors, interior and exterior lighting, electronic braking and engine management control.

Many automotive and industrial applications require higher voltages than are available on the input power supply rail. Supply voltages required for these systems can range from 36V (power seats and windows) to 1.8V (to drive low-voltage microprocessors). In addition, depending on where the PSU operates on the automotive power bus, it may be required to perform under very stringent power requirements.

Automotive subsystems with their inherent high voltage transients and high efficiency requirements place increasing demands on power supply designs. These supplies must provide high power, high efficiency and low noise from a very compact footprint and must maintain a high efficiency over a wide range of operational input voltages.

The MCP1630/V high-speed, microcontroller-adaptable Pulse Width Modulator (PWM) is capable of maintaining output regulation with no adverse effects on system performance or reliability. The MCP1630 Automotive Input Boost Converter Demo Board provides a better choice for automotive application design and high efficiency.

This chapter covers the following topics.

- What is the MCP1630 Automotive Input Boost Converter Demo Board?
- What the MCP1630 Automotive Input Boost Converter Demo Board Kit includes.

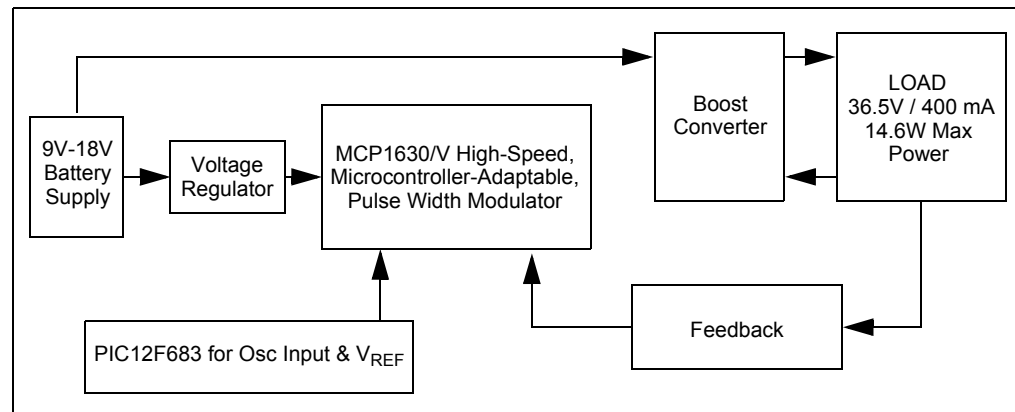

**FIGURE 1-1:** MCP1630 Automotive Input Boost Converter Demo Board Block Diagram.

## 1.2 WHAT IS THE MCP1630 AUTOMOTIVE INPUT BOOST CONVERTER DEMO BOARD?

The MCP1630 Automotive Input Boost Converter Demo Board demonstrates the use of a conventional boost topology with automotive input. The board also serves as a platform to evaluate the MCP1630/V devices.

The MCP1630/V inputs were developed to be easily attached to the I/O of a microcontroller. The Microcontroller Unit (MCU) supplies the oscillator pulses and reference voltage ( $V_{REF}$ ) to the MCP1630/V devices to provide the most flexible and adaptable power system. The power system switching frequency and maximum duty cycle are set using the I/O of the MCU. The reference input to the high-speed PWM can be external, a D/A Converter (DAC) output or as simple as an I/O output from the MCU. This enables the power system to adapt to many external signals and variables in order to optimize performance and facilitate calibration.

This board utilizes Microchip's MCP1630/V (high-speed PICmicro<sup>®</sup> MCU PWM) integrated with PIC12F683 (Flash MCU SOIC8) in automotive input application. Under normal operation, the vehicle voltage at the supply lines ranges between 9V-18V (12V system). The converter is capable of delivering an output voltage of 36.5V at 400 mA load current with maximum power of 14.6W. The line and load regulation is within the regulation band of 3%.

## 1.3 WHAT THE MCP1630 AUTOMOTIVE INPUT BOOST CONVERTER DEMO BOARD KIT INCLUDES

This MCP1630 Automotive Input Boost Converter Demo Board kit includes:

- MCP1630 Automotive Input Boost Converter Demo Board (102-00095)
- Analog and Interface Products Demonstration Boards CD-ROM (DS21912)
  - MCP1630 Automotive Input Boost Converter Demo Board User's Guide (DS51608)



# MCP1630 AUTOMOTIVE INPUT BOOST CONVERTER DEMO BOARD USER'S GUIDE

---

---

## Chapter 2. Installation and Operation

---

---

### 2.1 INTRODUCTION

The MCP1630 Automotive Input Boost Converter Demo Board demonstrates Microchip's high-speed pulse width modulator used for automotive applications. When used in conjunction with a microcontroller, the MCP1630/V devices will control the power system duty cycle to provide regulated output voltage. The PIC12F683 microcontroller is used to provide oscillator pulses at switching frequency of 500 kHz and set maximum duty cycle. The MCP1630/V devices generate duty cycles based on various external inputs. External signals include the input oscillator pulses from PIC12F683, the reference voltage and the feedback voltage. The output signal is a square wave pulse given to drive the MOSFET.

The PIC12F683 microcontroller is programmable, allowing the user to modify or develop their own firmware routines to further evaluate the MCP1630/V devices in this application.

### 2.2 FEATURES

The MCP1630 Automotive Input Boost Converter Demo Board has the following features:

- Compact size for an output power of 14.6W
- Tight line and load regulation and high efficiency over entire operating input voltage range
- PIC12F683 is used to generate reference voltage and oscillator signal at 500 kHz frequency at maximum duty cycle
- Proprietary features can be added by modifying the firmware contained in the PIC12F683
- Factory programmed source code is available

## 2.3 GETTING STARTED

The MCP1630 Automotive Input Boost Converter Demo Board is fully assembled and tested for automotive input. The board requires the use of an external input voltage source (+9V to 18V) and external load.

### 2.3.1 Power Input and Output Connection

#### 2.3.1.1 POWERING THE MCP1630 AUTOMOTIVE INPUT BOOST CONVERTER DEMO BOARD

1. Connect the positive side of the input source (+) to TP1.
2. Connect the negative or return side (-) of the input source to TP2. Refer to Figure 2-1. The input voltage source should be limited to the 0V to +18V range. For normal operation, the input voltage should be between +9V to +18V. The input voltage must not exceed an absolute maximum of +20V.

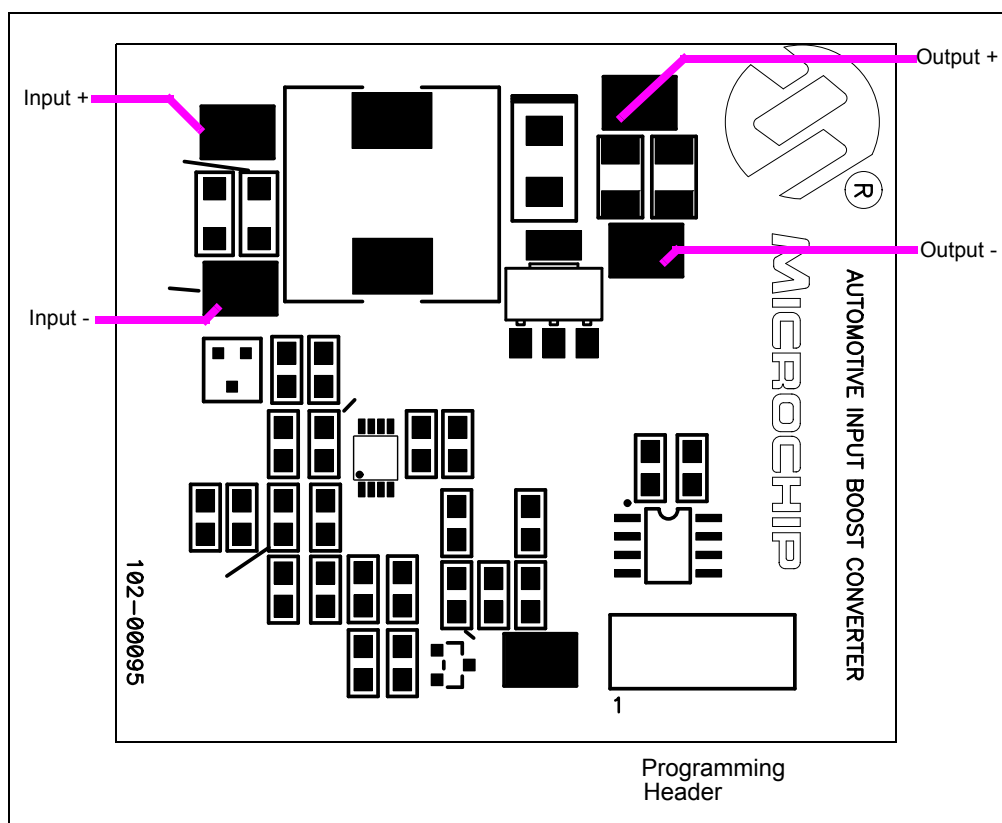

**FIGURE 2-1:** Set-up Configuration Diagram.

## 2.3.1.2 APPLY LOAD TO MCP1630 AUTOMOTIVE INPUT BOOST CONVERTER DEMO BOARD

A variable resistive load can be used to verify the line and load regulation. The load resistance is connected between the points TP3 and TP4. To measure the output voltage, connect the common point of a multimeter to TP4 and the positive terminal to TP3. By varying the load, the load regulation can be verified by measuring the output voltage over the entire load range of 0 mA to 400 mA. Similarly, the line regulation can be calculated by varying the line voltage from 9V to 18V and checking the output voltage.

### Evaluating the Application

The best way to evaluate the MCP1630 is to dig into the circuit and measure voltages and currents with a Digital Voltage Meter (DVM) and probe the board with an oscilloscope.

The firmware program in the PIC12F683 can also be edited to modify the operation of the application.

### Firmware

The PIC12F683 comes pre-programmed with firmware to operate the system as described above. The file listing and firmware flow diagram are shown in **Appendix C. "Demo Board Firmware"**.

The program is fairly simple and straight forward. There is an initialization routine at the beginning of the program.

The TRISIO register controls the direction of GPIO pins, and is configured to set GP2 (oscillator pulses to the MCP1630/V) and GP5 ( $V_{REF}$  voltage to MCP1630/V) as an output port.

The Capture/Compare/PWM (CCP) module contains a 16-bit register which can operate in PWM mode. The PWM period can be calculated by writing to the PR2 register. The PWM duty cycle is specified by writing to the CCPR1L register and to the CCP1CON <5:4> bits. Up to 10-bit resolution is available. The CCPR1L contains the eight MSbs and the CCP1CON <5:4> contains the two LSbs. This 10-bit value is represented by CCPR1L:CCP1CON<5:4>. The switching frequency is set to 500 kHz.

The user can obtain different output voltages by programming the MCU to obtain different  $V_{REF}$  voltages.

### Programming

Header J1 is provided for in-circuit programming. This is an optional feature since the MCP1630 Automotive Input Boost Converter Demo Board comes pre-programmed with firmware to operate the system. The PIC12F683 can be reprogrammed with the Baseline Flash Microcontroller Programmer (BFMP).

# **MCP1630 Automotive Input Boost Converter Demo Board User's Guide**

---

---

NOTES:



# MCP1630 AUTOMOTIVE INPUT BOOST CONVERTER DEMO BOARD USER'S GUIDE

---

---

## Appendix A. Schematic and Layouts

---

---

### A.1 INTRODUCTION

This appendix contains the following schematics and layouts for the MCP1630 Automotive Input Boost Converter Demo Board:

- Board – Schematic
- Board – Top Silk Layer
- Board – Top Metal Layer
- Board – Bottom Metal Layer

## A.2 BOARD – SCHEMATIC

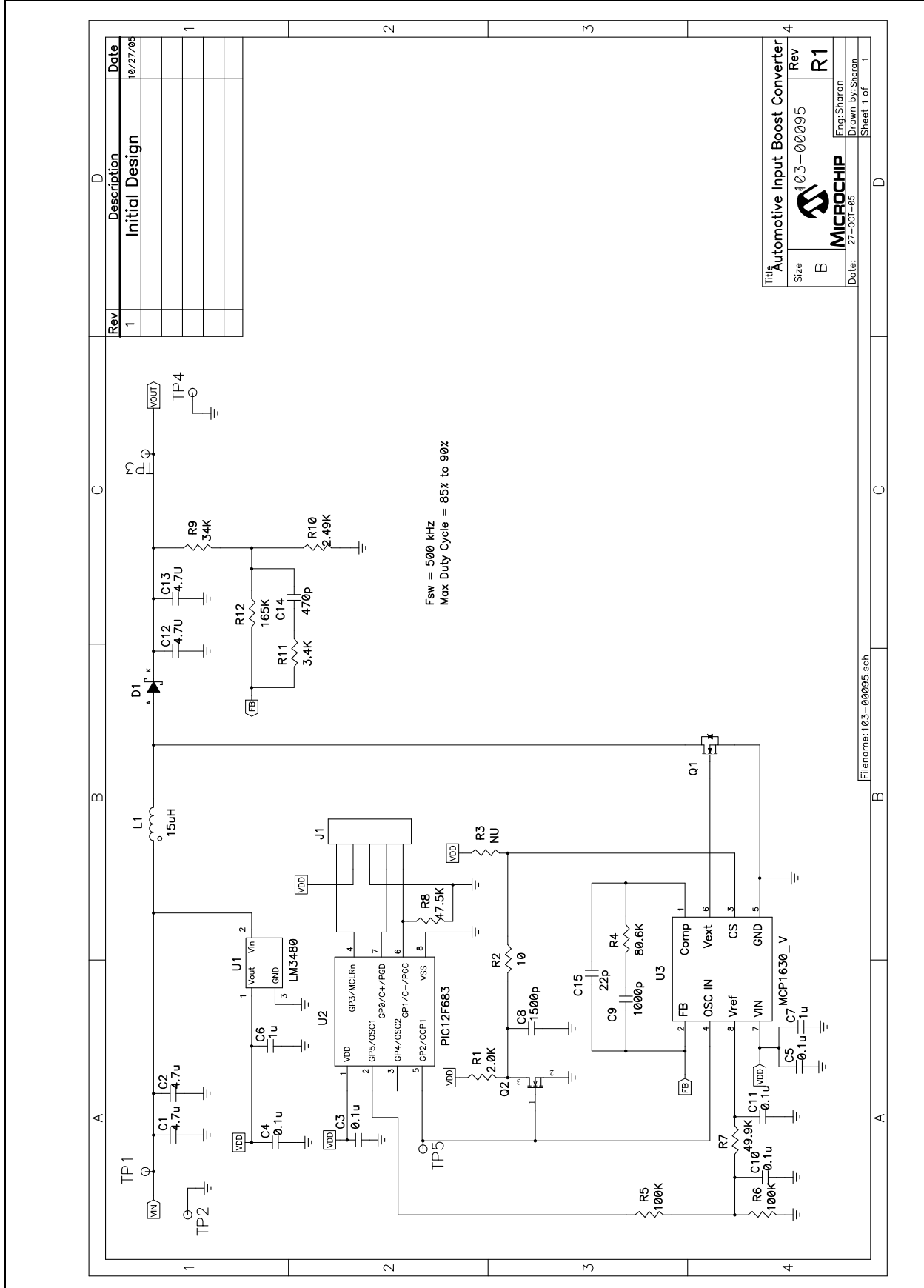



## A.3 BOARD – TOP SILK LAYER

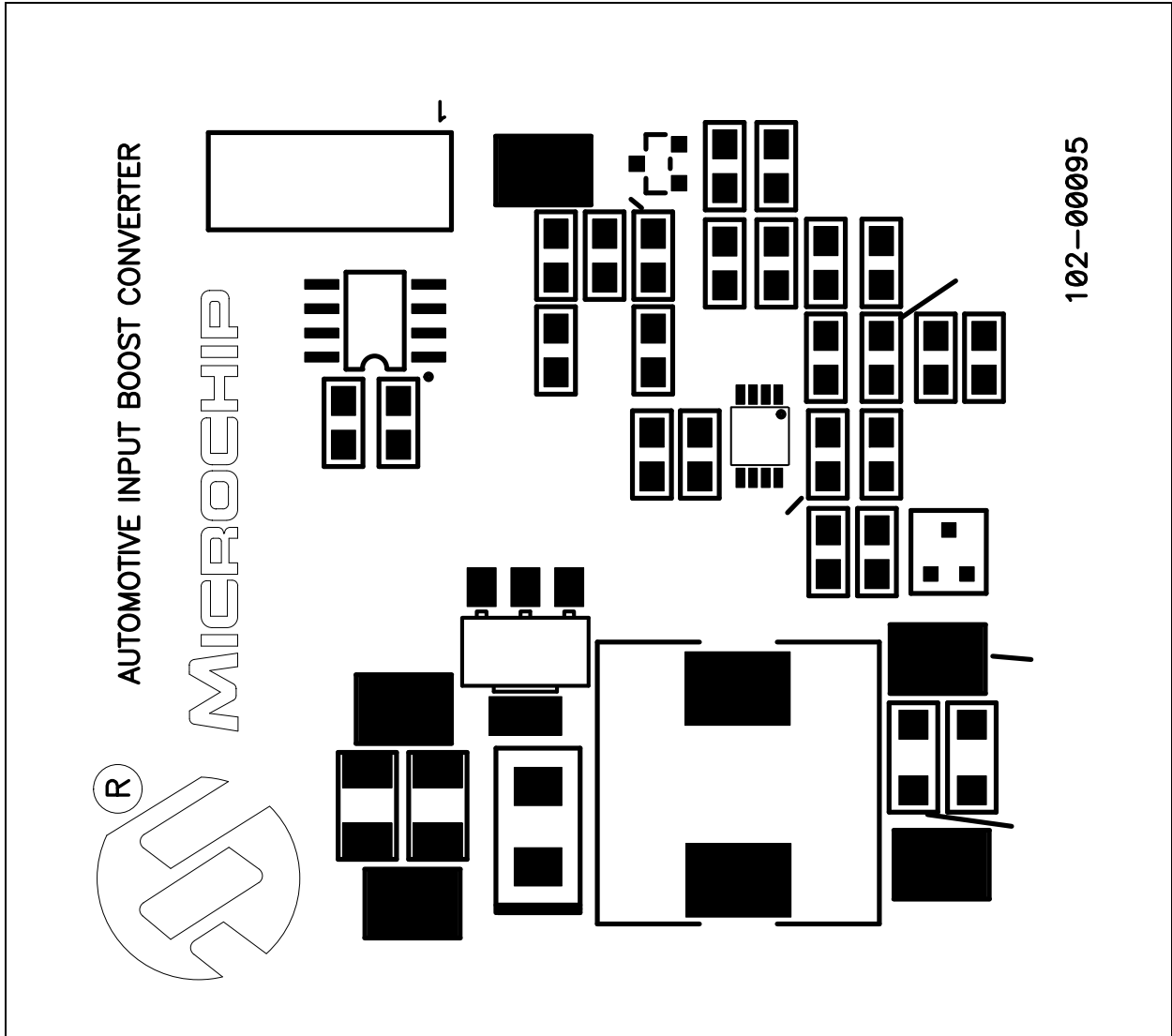

**A.4 BOARD – TOP METAL LAYER**

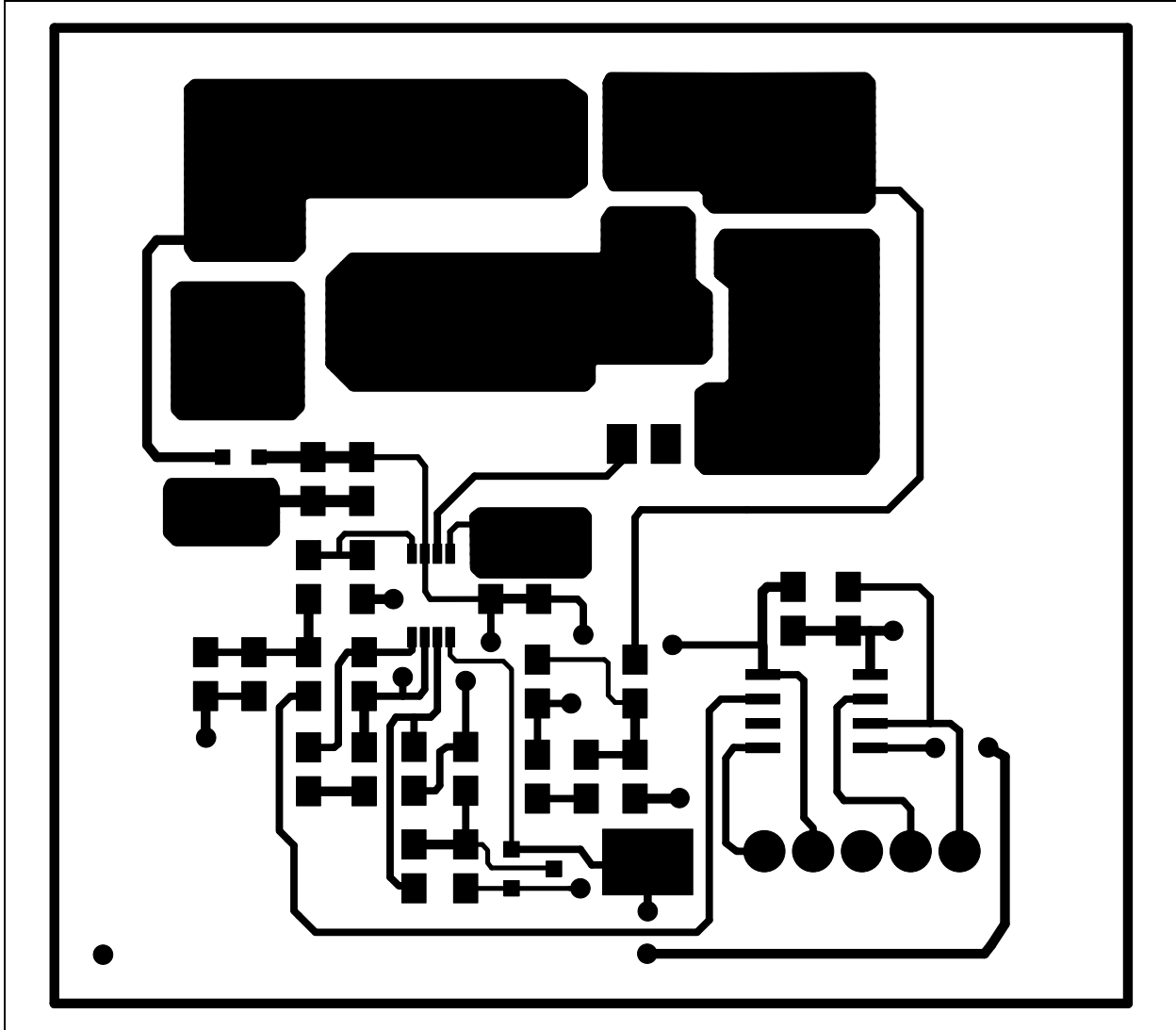

## A.5 BOARD – BOTTOM METAL LAYER

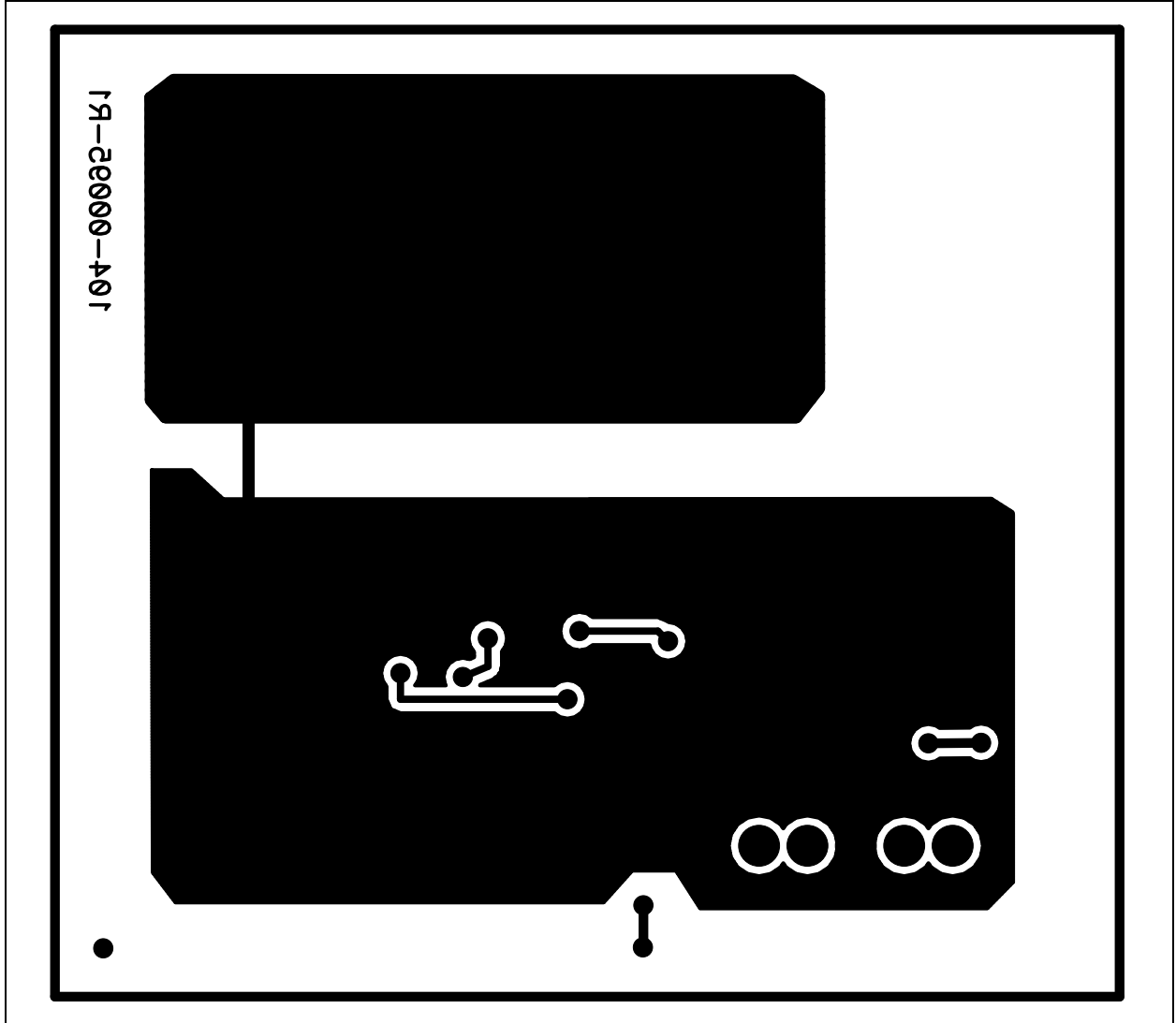

# **MCP1630 Automotive Input Boost Converter Demo Board User's Guide**

---

---

NOTES:

**Appendix B. Bill Of Materials (BOM)**

**TABLE B-1: BILL OF MATERIALS (BOM)**

Qty	Reference	Description	Manufacturer	Part Number
2	C1, C2	Cap 4.7uF 25V Ceramic X5R 1206	Panasonic® - ECG	ECJ-3YB1E475M
5	C3, C4, C5, C10, C11	Cap 0.1uF 16V Ceramic X7R 0805	Panasonic - ECG	ECJ-2VB1C104K
2	C6, C7	Cap 1uF 16V Ceramic X7R 0805	Panasonic - ECG	ECJ-2FB1C105K
1	C8	Cap 1500pF 100V Ceramic X7R 0805	Panasonic - ECG	ECJ-2VB2A152K
1	C9	Cap 1000pF 50V Cerm Chip 0805	Panasonic - ECG	ECJ-2VC1H102J
2	C12, C13	Cap Cer 4.7uF 50V 10% X7R 1210	Murata	GRM32ER71H475KA88L
1	C14	Cap 470pF 50V Cerm Chip 0805 SMD	Panasonic - ECG	ECJ-2VC1H471J
1	C15	Cap 22pF 50V Cerm Chip 0805 SMD	Panasonic - ECG	ECJ-2VC1H220J
1	D1	Diode Schottky 60V 1A SMB	International Rectifier	10BQ060
1	J1	Conn Header 5 Pos.100 Vert Tin	Molex	22-03-2051
1	L1	Inductor Shielded Drum Power 15uH SMD	Coiltronics	DR125-150-R
1	Q1	MOSFET N-CH 55V 3.1A SOT-23	International Rectifier	IRLL024N
1	Q2	MOSFET N-CH 60V 280mA SOT-33	Fairchild Semiconductor®	NDS7002A
1	R1	Res 2.00K Ohm 1/8W 1% 0805 SMD	Panasonic - ECG	ERJ-6ENF2001V
1	R2	Res 10.0K Ohm 1/8W 1% 0805 SMD	Panasonic - ECG	ERJ-6ENF10R0V
1	R3	Not Used	—	—
1	R4	Res 80.6K Ohm 1/8W 1% 0805 SMD	Panasonic - ECG	ERJ-6ENF8062V
2	R5, R6	Res 100K Ohm 1/8W 1% 0805 SMD	Panasonic - ECG	ERJ-6ENF1003V
1	R7	Res 49.9K Ohm 1/8W 1% 0805 SMD	Panasonic - ECG	ERJ-6ENF4992V
1	R8	Res 47.5K Ohm 1/8W 1% 0805 SMD	Panasonic - ECG	ERJ-6ENF4752V
1	R9	Res 34.0K Ohm 1/8W 1% 0805 SMD	Panasonic - ECG	ERJ-6ENF3402V
1	R10	Res 2.49K Ohm 1/8W 1% 0805 SMD	Panasonic - ECG	ERJ-6ENF2491V
1	R11	Res 3.40K Ohm 1/8W 1% 0805 SMD	Panasonic - ECG	ERJ-6ENF3401V
1	R12	Res 165K Ohm 1/8W 1% 0805 SMD	Panasonic - ECG	ERJ-6ENF1653V
5	TP1,TP2, TP3,TP4, TP5	PC Test point compact SMT	Keystone Electronics®	5016
1	U1	IC 5.0 100 mA LDO Vreg SOT23	National Semiconductor®	LM3480IM3-5.0
1	U2	IC MCU Flash 2KX14 8SOIC	Microchip Technology Inc	PIC12F683-I/SN
1	U3	IC PWM HS MCU-Adaptable 8MSOP	Microchip Technology Inc	MCP1630V-E/MS

**Note 1:** The components listed in this Bill of Materials are representative of the PCB assembly. The released BOM used in manufacturing uses all RoHS-compliant components.

NOTES:

---

---

**Appendix C. Demo Board Firmware**

---

---

**C.1 DEVICE FIRMWARE**

For the latest copy of the MCP1630 Automotive Input Boost Converter Demo Board User's Guide firmware, visit our web site at [www.microchip.com](http://www.microchip.com)

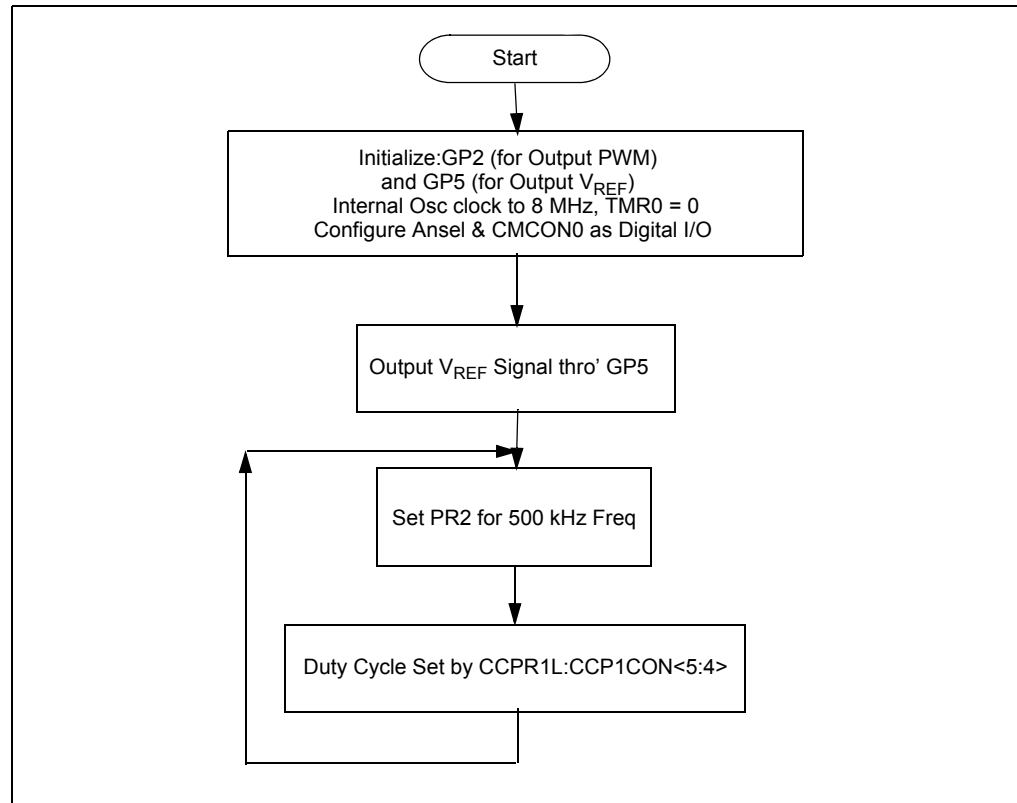

**FIGURE C-1:** *Firmware Flowchart.*



---

---

## WORLDWIDE SALES AND SERVICE

---

---

### AMERICAS

**Corporate Office**  
2355 West Chandler Blvd.  
Chandler, AZ 85224-6199  
Tel: 480-792-7200  
Fax: 480-792-7277  
Technical Support:  
<http://support.microchip.com>  
Web Address:  
[www.microchip.com](http://www.microchip.com)

**Atlanta**  
Duluth, GA  
Tel: 678-957-9614  
Fax: 678-957-1455

**Boston**  
Westborough, MA  
Tel: 774-760-0087  
Fax: 774-760-0088

**Chicago**  
Itasca, IL  
Tel: 630-285-0071  
Fax: 630-285-0075

**Dallas**  
Addison, TX  
Tel: 972-818-7423  
Fax: 972-818-2924

**Detroit**  
Farmington Hills, MI  
Tel: 248-538-2250  
Fax: 248-538-2260

**Kokomo**  
Kokomo, IN  
Tel: 765-864-8360  
Fax: 765-864-8387

**Los Angeles**  
Mission Viejo, CA  
Tel: 949-462-9523  
Fax: 949-462-9608

**Santa Clara**  
Santa Clara, CA  
Tel: 408-961-6444  
Fax: 408-961-6445

**Toronto**  
Mississauga, Ontario,  
Canada  
Tel: 905-673-0699  
Fax: 905-673-6509

### ASIA/PACIFIC

**Asia Pacific Office**  
Suites 3707-14, 37th Floor  
Tower 6, The Gateway  
Harbour City, Kowloon  
Hong Kong  
Tel: 852-2401-1200  
Fax: 852-2401-3431

**Australia - Sydney**  
Tel: 61-2-9868-6733  
Fax: 61-2-9868-6755

**China - Beijing**  
Tel: 86-10-8528-2100  
Fax: 86-10-8528-2104

**China - Chengdu**  
Tel: 86-28-8665-5511  
Fax: 86-28-8665-7889

**China - Fuzhou**  
Tel: 86-591-8750-3506  
Fax: 86-591-8750-3521

**China - Hong Kong SAR**  
Tel: 852-2401-1200  
Fax: 852-2401-3431

**China - Qingdao**  
Tel: 86-532-8502-7355  
Fax: 86-532-8502-7205

**China - Shanghai**  
Tel: 86-21-5407-5533  
Fax: 86-21-5407-5066

**China - Shenyang**  
Tel: 86-24-2334-2829  
Fax: 86-24-2334-2393

**China - Shenzhen**  
Tel: 86-755-8203-2660  
Fax: 86-755-8203-1760

**China - Shunde**  
Tel: 86-757-2839-5507  
Fax: 86-757-2839-5571

**China - Wuhan**  
Tel: 86-27-5980-5300  
Fax: 86-27-5980-5118

**China - Xian**  
Tel: 86-29-8833-7250  
Fax: 86-29-8833-7256

### ASIA/PACIFIC

**India - Bangalore**  
Tel: 91-80-4182-8400  
Fax: 91-80-4182-8422

**India - New Delhi**  
Tel: 91-11-4160-8631  
Fax: 91-11-4160-8632

**India - Pune**  
Tel: 91-20-2566-1512  
Fax: 91-20-2566-1513

**Japan - Yokohama**  
Tel: 81-45-471-6166  
Fax: 81-45-471-6122

**Korea - Gumi**  
Tel: 82-54-473-4301  
Fax: 82-54-473-4302

**Korea - Seoul**  
Tel: 82-2-554-7200  
Fax: 82-2-558-5932 or  
82-2-558-5934

**Malaysia - Penang**  
Tel: 60-4-646-8870  
Fax: 60-4-646-5086

**Philippines - Manila**  
Tel: 63-2-634-9065  
Fax: 63-2-634-9069

**Singapore**  
Tel: 65-6334-8870  
Fax: 65-6334-8850

**Taiwan - Hsin Chu**  
Tel: 886-3-572-9526  
Fax: 886-3-572-6459

**Taiwan - Kaohsiung**  
Tel: 886-7-536-4818  
Fax: 886-7-536-4803

**Taiwan - Taipei**  
Tel: 886-2-2500-6610  
Fax: 886-2-2508-0102

**Thailand - Bangkok**  
Tel: 66-2-694-1351  
Fax: 66-2-694-1350

### EUROPE

**Austria - Wels**  
Tel: 43-7242-2244-39  
Fax: 43-7242-2244-393

**Denmark - Copenhagen**  
Tel: 45-4450-2828  
Fax: 45-4485-2829

**France - Paris**  
Tel: 33-1-69-53-63-20  
Fax: 33-1-69-30-90-79

**Germany - Munich**  
Tel: 49-89-627-144-0  
Fax: 49-89-627-144-44

**Italy - Milan**  
Tel: 39-0331-742611  
Fax: 39-0331-466781

**Netherlands - Drunen**  
Tel: 31-416-690399  
Fax: 31-416-690340

**Spain - Madrid**  
Tel: 34-91-708-08-90  
Fax: 34-91-708-08-91

**UK - Wokingham**  
Tel: 44-118-921-5869  
Fax: 44-118-921-5820