



**TAOS Inc.**

**is now**

**ams AG**

The technical content of this TAOS datasheet is still valid.

**Contact information:**

**Headquarters:**

ams AG

Tobelbaderstrasse 30

8141 Unterpremstaetten, Austria

Tel: +43 (0) 3136 500 0

e-Mail: [ams\\_sales@ams.com](mailto:ams_sales@ams.com)

Please visit our website at [www.ams.com](http://www.ams.com)

## Features

- **Red, Green, Blue (RGB), and Clear Light Sensing with IR Blocking Filter**
  - Programmable Analog Gain and Integration Time
  - 3,800,000:1 Dynamic Range
  - Very High Sensitivity — Ideally Suited for Operation Behind Dark Glass
- **Maskable Interrupt**
  - Programmable Upper and Lower Thresholds with Persistence Filter
- **Power Management**
  - Low Power — 2.5- $\mu$ A Sleep State
  - 65- $\mu$ A Wait State with Programmable Wait State Time from 2.4 ms to > 7 Seconds
- **I<sup>2</sup>C Fast Mode Compatible Interface**
  - Data Rates up to 400 kbit/s
  - Input Voltage Levels Compatible with  $V_{DD}$  or 1.8 V Bus
- **Register Set and Pin Compatible with the TCS3x71 Series**
- **Small 2 mm  $\times$  2.4 mm Dual Flat No-Lead (FN) Package**

PACKAGE FN  
DUAL FLAT NO-LEAD  
(TOP VIEW)

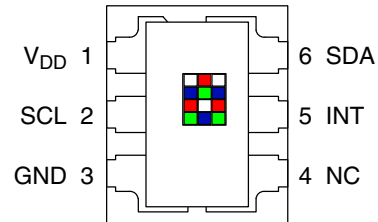

Package Drawing Not to Scale

## Applications

- RGB LED Backlight Control
- Light Color Temperature Measurement
- Ambient Light Sensing for Display Backlight Control
- Fluid and Gas Analysis
- Product Color Verification and Sorting

## End Products and Market Segments

- TVs, Mobile Handsets, Tablets, Computers, and Monitors
- Consumer and Commercial Printing
- Medical and Health Fitness
- Solid State Lighting (SSL) and Digital Signage
- Industrial Automation

## Description

The TCS3472 device provides a digital return of red, green, blue (RGB), and clear light sensing values. An IR blocking filter, integrated on-chip and localized to the color sensing photodiodes, minimizes the IR spectral component of the incoming light and allows color measurements to be made accurately. The high sensitivity, wide dynamic range, and IR blocking filter make the TCS3472 an ideal color sensor solution for use under varying lighting conditions and through attenuating materials.

The TCS3472 color sensor has a wide range of applications including RGB LED backlight control, solid-state lighting, health/fitness products, industrial process controls and medical diagnostic equipment. In addition, the IR blocking filter enables the TCS3472 to perform ambient light sensing (ALS). Ambient light sensing is widely used in display-based products such as cell phones, notebooks, and TVs to sense the lighting environment and enable automatic display brightness for optimal viewing and power savings. The TCS3472, itself, can enter a lower-power wait state between light sensing measurements to further reduce the average power consumption.

**TCS3472**  
**COLOR LIGHT-TO-DIGITAL CONVERTER**  
**with IR FILTER**  
 TAOS135 – AUGUST 2012

**Functional Block Diagram**

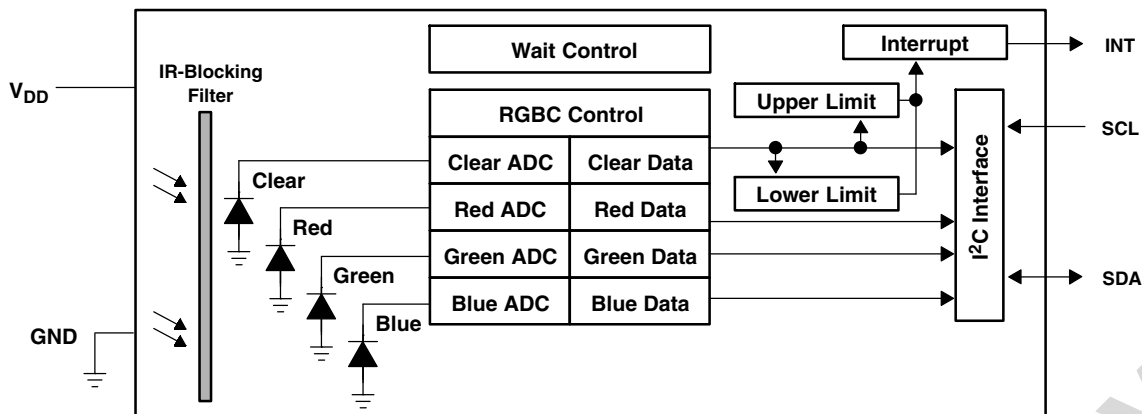

**Detailed Description**

The TCS3472 light-to-digital converter contains a 3 × 4 photodiode array, four analog-to-digital converters (ADC) that integrate the photodiode current, data registers, a state machine, and an I<sup>2</sup>C interface. The 3 × 4 photodiode array is composed of red-filtered, green-filtered, blue-filtered, and clear (unfiltered) photodiodes. In addition, the photodiodes are coated with an IR-blocking filter. The four integrating ADCs simultaneously convert the amplified photodiode currents to a 16-bit digital value. Upon completion of a conversion cycle, the results are transferred to the data registers, which are double-buffered to ensure the integrity of the data. All of the internal timing, as well as the low-power wait state, is controlled by the state machine.

Communication of the TCS3472 data is accomplished over a fast, up to 400 kHz, two-wire I<sup>2</sup>C serial bus. The industry standard I<sup>2</sup>C bus facilitates easy, direct connection to microcontrollers and embedded processors.

In addition to the I<sup>2</sup>C bus, the TCS3472 provides a separate interrupt signal output. When interrupts are enabled, and user-defined thresholds are exceeded, the active-low interrupt is asserted and remains asserted until it is cleared by the controller. This interrupt feature simplifies and improves the efficiency of the system software by eliminating the need to poll the TCS3472. The user can define the upper and lower interrupt thresholds and apply an interrupt persistence filter. The interrupt persistence filter allows the user to define the number of consecutive out-of-threshold events necessary before generating an interrupt. The interrupt output is open-drain, so it can be wire-ORed with other devices.

**Terminal Functions**

TERMINAL NAME	NO.	TYPE	DESCRIPTION
GND	3		Power supply ground. All voltages are referenced to GND.
INT	5	O	Interrupt — open drain (active low).
NC	4	O	No connect — do not connect.
SCL	2	I	I <sup>2</sup> C serial clock input terminal — clock signal for I <sup>2</sup> C serial data.
SDA	6	I/O	I <sup>2</sup> C serial data I/O terminal — serial data I/O for I <sup>2</sup> C .
V <sub>DD</sub>	1		Supply voltage.

**Available Options**

DEVICE	ADDRESS	PACKAGE – LEADS	INTERFACE DESCRIPTION	ORDERING NUMBER
TCS34721†	0x39	FN–6	I <sup>2</sup> C V <sub>bus</sub> = V <sub>DD</sub> Interface	TCS34721FN
TCS34723†	0x39	FN–6	I <sup>2</sup> C V <sub>bus</sub> = 1.8 V Interface	TCS34723FN
TCS34725	0x29	FN–6	I <sup>2</sup> C V <sub>bus</sub> = V <sub>DD</sub> Interface	TCS34725FN
TCS34727	0x29	FN–6	I <sup>2</sup> C V <sub>bus</sub> = 1.8 V Interface	TCS34727FN

† Contact TAOS for availability.

**Absolute Maximum Ratings over operating free-air temperature range (unless otherwise noted)†**

Supply voltage, V <sub>DD</sub> (Note 1)	3.8 V
Input terminal voltage	–0.5 V to 3.8 V
Output terminal voltage	–0.5 V to 3.8 V
Output terminal current	–1 mA to 20 mA
Storage temperature range, T <sub>stg</sub>	–40°C to 85°C
ESD tolerance, human body model	2000 V

† Stresses beyond those listed under “absolute maximum ratings” may cause permanent damage to the device. These are stress ratings only, and functional operation of the device at these or any other conditions beyond those indicated under “recommended operating conditions” is not implied. Exposure to absolute-maximum-rated conditions for extended periods may affect device reliability.

NOTE 1: All voltages are with respect to GND.

**Recommended Operating Conditions**

	MIN	NOM	MAX	UNIT
Supply voltage, V <sub>DD</sub> (TCS34721 & TCS34725) (I <sup>2</sup> C V <sub>bus</sub> = V <sub>DD</sub> )	2.7	3	3.6	V
Supply voltage, V <sub>DD</sub> (TCS34723 & TCS34727) (I <sup>2</sup> C V <sub>bus</sub> = 1.8 V)	2.7	3	3.3	V
Operating free-air temperature, T <sub>A</sub>	–30		70	°C

**TCS3472**  
**COLOR LIGHT-TO-DIGITAL CONVERTER**  
**with IR FILTER**

TAOS135 – AUGUST 2012

**Operating Characteristics,  $V_{DD} = 3\text{ V}$ ,  $T_A = 25^\circ\text{C}$  (unless otherwise noted)**

PARAMETER		TEST CONDITIONS	MIN	TYP	MAX	UNIT
$I_{DD}$	Supply current	Active		235	330	$\mu\text{A}$
		Wait state		65		
		Sleep state — no $I^2C$ activity		2.5	10	
$V_{OL}$	INT, SDA output low voltage	3 mA sink current	0		0.4	V
		6 mA sink current	0		0.6	
$I_{LEAK}$	Leakage current, SDA, SCL, INT pins		-5		5	$\mu\text{A}$
$I_{LEAK}$	Leakage current, LDR pin		-5		5	$\mu\text{A}$
$V_{IH}$	SCL, SDA input high voltage	TCS34721 & TCS34725	0.7 $V_{DD}$			V
		TCS34723 & TCS34727	1.25			
$V_{IL}$	SCL, SDA input low voltage	TCS34721 & TCS34725	0.3 $V_{DD}$			V
		TCS34723 & TCS34727	0.54			

**Optical Characteristics,  $V_{DD} = 3\text{ V}$ ,  $T_A = 25^\circ\text{C}$ , **AGAIN = 16x**, **ATIME = 0xF6** (unless otherwise noted) (Note 1)**

PARAMETER	TEST CONDITIONS	Red Channel			Green Channel			Blue Channel			Clear Channel			UNIT
		MIN	TYP	MAX	MIN	TYP	MAX	MIN	TYP	MAX	MIN	TYP	MAX	
$R_e$ Irradiance responsivity	$\lambda_D = 465\text{ nm}$ Note 2	0%		15%	10%		42%	65%		88%	11.0	13.8	16.6	counts/ $\mu\text{W}/\text{cm}^2$
	$\lambda_D = 525\text{ nm}$ Note 3	4%		25%	60%		85%	10%		45%	13.2	16.6	20.0	
	$\lambda_D = 615\text{ nm}$ Note 4	80%		110%	0%		14%	5%		24%	15.6	19.5	23.4	

- NOTES: 1. The percentage shown represents the ratio of the respective red, green, or blue channel value to the clear channel value.  
2. The 465 nm input irradiance is supplied by an InGaN light-emitting diode with the following characteristics: dominant wavelength  $\lambda_D = 465\text{ nm}$ , spectral halfwidth  $\Delta\lambda_{1/2} = 22\text{ nm}$ .  
3. The 525 nm input irradiance is supplied by an InGaN light-emitting diode with the following characteristics: dominant wavelength  $\lambda_D = 525\text{ nm}$ , spectral halfwidth  $\Delta\lambda_{1/2} = 35\text{ nm}$ .  
4. The 615 nm input irradiance is supplied by a AlInGaP light-emitting diode with the following characteristics: dominant wavelength  $\lambda_D = 615\text{ nm}$ , spectral halfwidth  $\Delta\lambda_{1/2} = 15\text{ nm}$ .

**RGBC Characteristics,  $V_{DD} = 3\text{ V}$ ,  $T_A = 25^\circ\text{C}$ , **AGAIN = 16x**, **AEN = 1** (unless otherwise noted)**

PARAMETER	TEST CONDITIONS	MIN	TYP	MAX	UNIT
Dark ADC count value	$E_e = 0$ , AGAIN = 60x, ATIME = 0xD6 (100 ms)	0	1	5	counts
ADC integration time step size	ATIME = 0xFF	2.27	2.4	2.56	ms
ADC number of integration steps (Note 5)		1		256	steps
ADC counts per step (Note 5)		0		1024	counts
ADC count value (Note 5)	ATIME = 0xC0 (153.6 ms)	0		65535	counts
Gain scaling, relative to 1x gain setting	4x	3.8	4	4.2	x
	16x	15	16	16.8	
	60x	58	60	63	

NOTE 5: Parameter ensured by design and is not tested.

**Wait Characteristics,  $V_{DD} = 3\text{ V}$ ,  $T_A = 25^\circ\text{C}$ , WEN = 1 (unless otherwise noted)**

PARAMETER	TEST CONDITIONS	CHANNEL	MIN	TYP	MAX	UNIT
Wait step size	WTIME = 0xFF		2.27	2.4	2.56	ms
Wait number of integration steps (Note 1)			1		256	steps

NOTE 1: Parameter ensured by design and is not tested.

**AC Electrical Characteristics,  $V_{DD} = 3\text{ V}$ ,  $T_A = 25^\circ\text{C}$  (unless otherwise noted)**

PARAMETER†	TEST CONDITIONS	MIN	TYP	MAX	UNIT
$f_{(SCL)}$ Clock frequency (I <sup>2</sup> C only)		0		400	kHz
$t_{(BUF)}$ Bus free time between start and stop condition		1.3			$\mu\text{s}$
$t_{(HDSTA)}$ Hold time after (repeated) start condition. After this period, the first clock is generated.		0.6			$\mu\text{s}$
$t_{(SUSTA)}$ Repeated start condition setup time		0.6			$\mu\text{s}$
$t_{(SUSTO)}$ Stop condition setup time		0.6			$\mu\text{s}$
$t_{(HDDAT)}$ Data hold time		0			$\mu\text{s}$
$t_{(SUDAT)}$ Data setup time		100			ns
$t_{(LOW)}$ SCL clock low period		1.3			$\mu\text{s}$
$t_{(HIGH)}$ SCL clock high period		0.6			$\mu\text{s}$
$t_F$ Clock/data fall time				300	ns
$t_R$ Clock/data rise time				300	ns
$C_i$ Input pin capacitance				10	pF

† Specified by design and characterization; not production tested.

**PARAMETER MEASUREMENT INFORMATION**

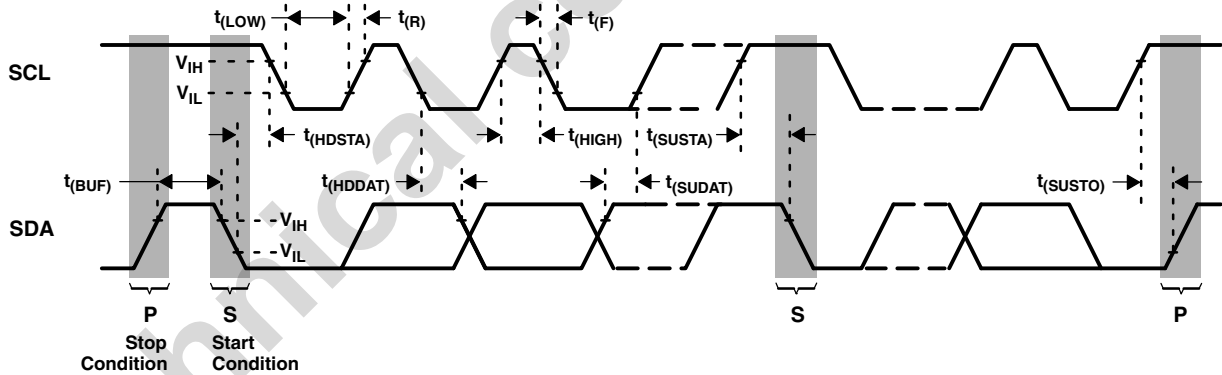
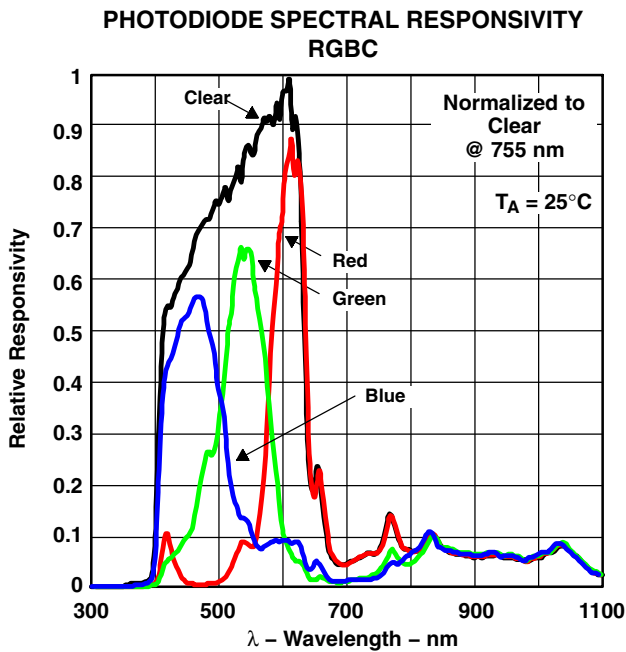
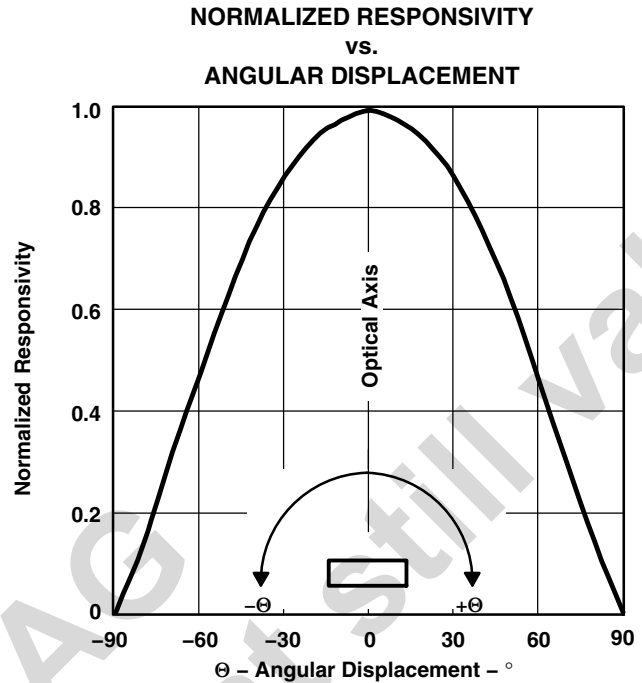

Figure 1. Timing Diagrams

**TYPICAL CHARACTERISTICS**



**Figure 2**



**Figure 3**

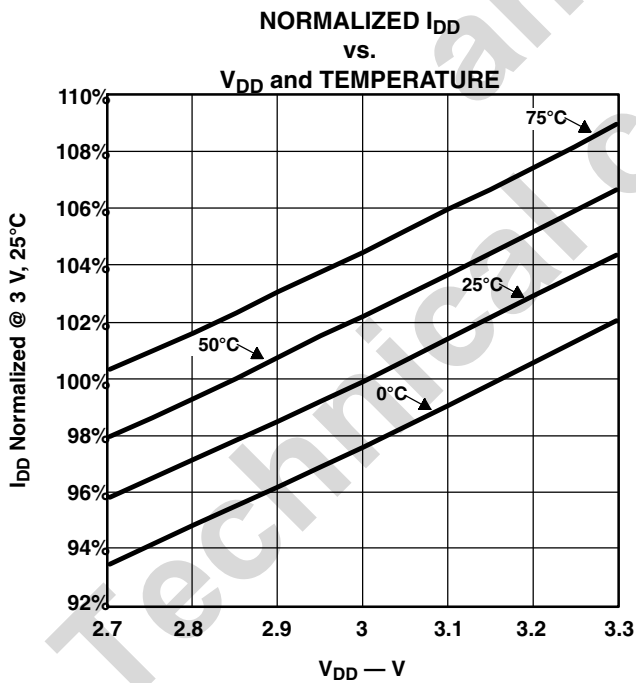

**Figure 4**

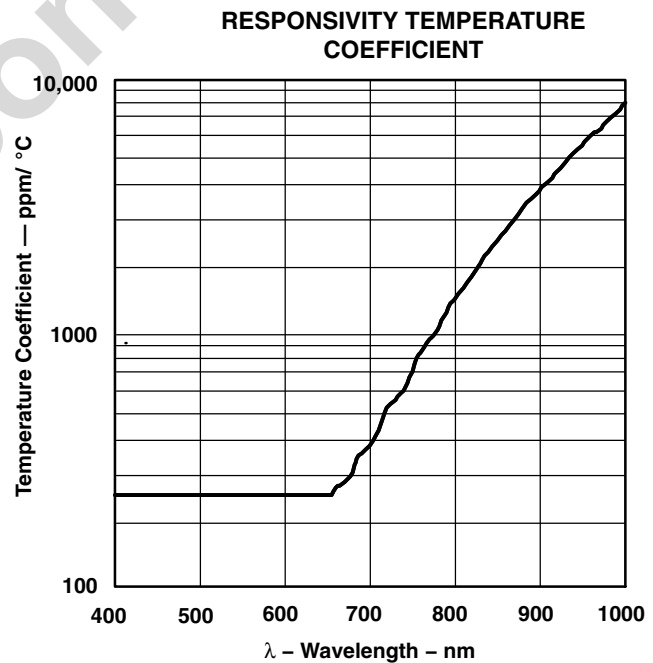

**Figure 5**

## PRINCIPLES OF OPERATION

### System States

An internal state machine provides system control of the RGBC and power management features of the device. At power up, an internal power-on-reset initializes the device and puts it in a low-power Sleep state.

When a start condition is detected on the I<sup>2</sup>C bus, the device transitions to the Idle state where it checks the Enable Register (0x00) PON bit. If PON is disabled, the device will return to the Sleep state to save power. Otherwise, the device will remain in the Idle state until the RGBC function is enabled (AEN). Once enabled, the device will execute the Wait and RGBC states in sequence as indicated in Figure 5. Upon completion and return to Idle, the device will automatically begin a new Wait-RGBC cycle as long as PON and AEN remain enabled.

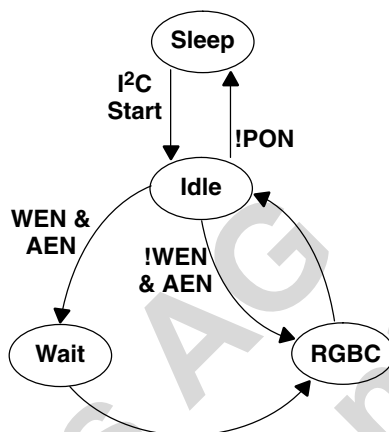

Figure 6. Simplified State Diagram





**TCS3472**  
**COLOR LIGHT-TO-DIGITAL CONVERTER**  
**with IR FILTER**

TAOS135 – AUGUST 2012

**RGBC Operation**

The RGBC engine contains RGBC gain control (AGAIN) and four integrating analog-to-digital converters (ADC) for the RGBC photodiodes. The RGBC integration time (ATIME) impacts both the resolution and the sensitivity of the RGBC reading. Integration of all four channels occurs simultaneously and upon completion of the conversion cycle, the results are transferred to the color data registers. This data is also referred to as channel count.

The transfers are double-buffered to ensure that invalid data is not read during the transfer. After the transfer, the device automatically moves to the next state in accordance with the configured state machine.

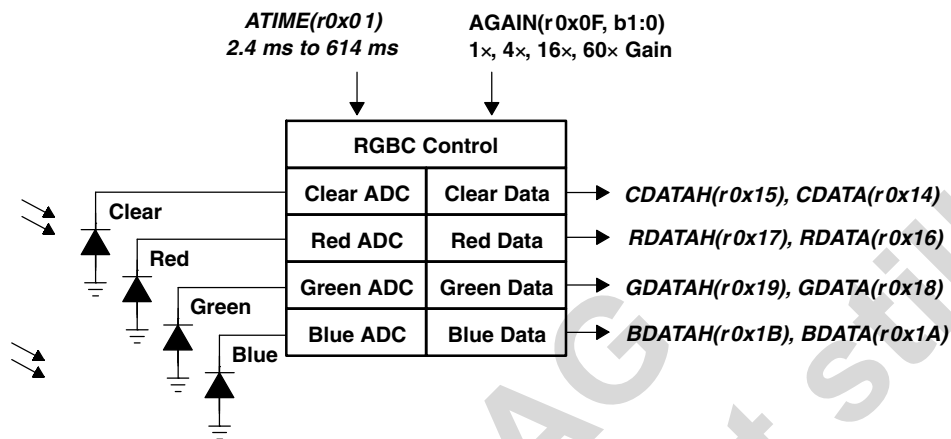

**Figure 7. RGBC Operation**

**NOTE:** In this document, the nomenclature uses the bit field name in italics followed by the register address and bit number to allow the user to easily identify the register and bit that controls the function. For example, the power on (PON) is in register 0x00, bit 0. This is represented as *PON (r0x00:b0)*.

The registers for programming the integration and wait times are a 2's compliment values. The actual time can be calculated as follows:

$$ATIME = 256 - \text{Integration Time} / 2.4 \text{ ms}$$

Inversely, the time can be calculated from the register value as follows:

$$\text{Integration Time} = 2.4 \text{ ms} \times (256 - ATIME)$$

For example, if a 100-ms integration time is needed, the device needs to be programmed to:

$$256 - (100 / 2.4) = 256 - 42 = 214 = 0xD6$$

Conversely, the programmed value of 0xC0 would correspond to:

$$(256 - 0xC0) \times 2.4 = 64 \times 2.4 = 154 \text{ ms.}$$

## Interrupts

The interrupt feature simplifies and improves system efficiency by eliminating the need to poll the sensor for light intensity values outside of a user-defined range. While the interrupt function is always enabled and its status is available in the status register (0x13), the output of the interrupt state can be enabled using the RGBC interrupt enable (AIEN) field in the enable register (0x00).

Two 16-bit interrupt threshold registers allow the user to set limits below and above a desired light level. An interrupt can be generated when the Clear data (CDATA) is less than the Clear interrupt low threshold (AILTx) or is greater than the Clear interrupt high threshold (AIHTx).

It is important to note that the thresholds are evaluated in sequence, first the low threshold, then the high threshold. As a result, if the low threshold is set above the high threshold, the high threshold is ignored and only the low threshold is evaluated.

To further control when an interrupt occurs, the device provides a persistence filter. The persistence filter allows the user to specify the number of consecutive out-of-range Clear occurrences before an interrupt is generated. The persistence filter register (0x0C) allows the user to set the Clear persistence filter (APERS) value. See the persistence filter register for details on the persistence filter value. Once the persistence filter generates an interrupt, it will continue until a special function interrupt clear command is received (see command register).

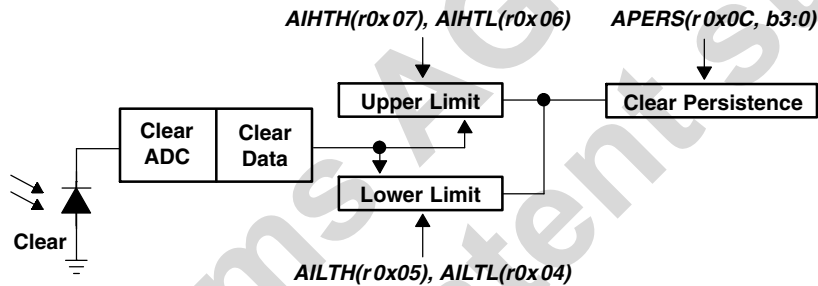

Figure 8. Programmable Interrupt

**TCS3472**  
**COLOR LIGHT-TO-DIGITAL CONVERTER**  
**with IR FILTER**

TAOS135 – AUGUST 2012

**System Timing**

The system state machine shown in Figure 5 provides an overview of the states and state transitions that provide system control of the device. This section highlights the programmable features, which affect the state machine cycle time, and provides details to determine system level timing.

When the power management feature is enabled (WEN), the state machine will transition to the Wait state. The wait time is determined by WLONG, which extends normal operation by 12X when asserted, and WTIME. The formula to determine the wait time is given in the box associated with the Wait state in Figure 9.

When the RGBC feature is enabled (AEN), the state machine will transition through the RGBC Init and RGBC ADC states. The RGBC Init state takes 2.4 ms, while the RGBC ADC time is dependent on the integration time (ATIME). The formula to determine RGBC ADC time is given in the associated box in Figure 9. If an interrupt is generated as a result of the RGBC cycle, it will be asserted at the end of the RGBC ADC.

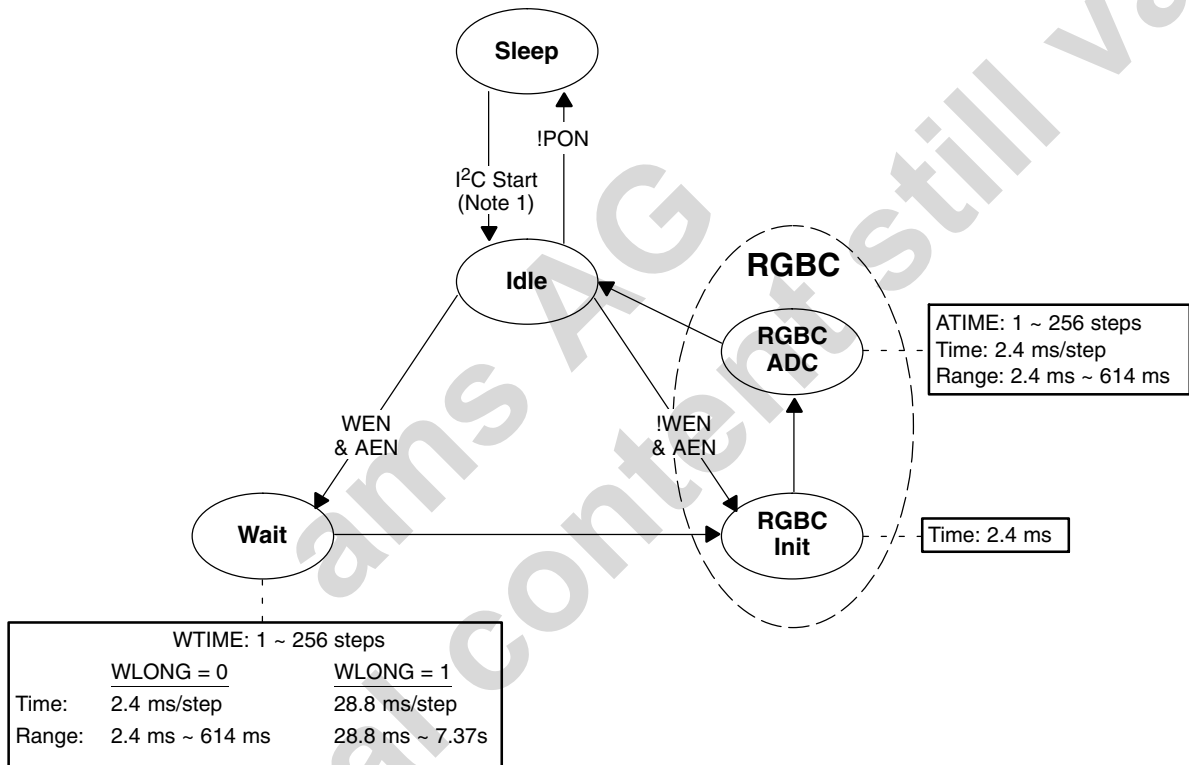

- Notes: 1. There is a 2.4 ms warm-up delay if PON is enabled. If PON is not enabled, the device will return to the Sleep state as shown.  
 2. PON, WEN, and AEN are fields in the Enable register (0x00).

**Figure 9. Detailed State Diagram**

## Power Management

Power consumption can be managed with the Wait state, because the Wait state typically consumes only 65  $\mu\text{A}$  of  $I_{DD}$  current. An example of the power management feature is given below. With the assumptions provided in the example, average  $I_{DD}$  is estimated to be 152  $\mu\text{A}$ .

**Table 1. Power Management**

SYSTEM STATE MACHINE STATE	PROGRAMMABLE PARAMETER	PROGRAMMED VALUE	DURATION	TYPICAL CURRENT
Wait	WTIME	0xEE	43.2 ms	0.065 mA
	WLONG	0		
RGBC Init			2.40 ms	0.235 mA
RGBC ADC	ATIME	0xEE	43.2 ms	0.235 mA

$$\text{Average } I_{DD} \text{ Current} = ((43.2 \times 0.065) + (43.2 \times 0.235) + (2.40 \times 0.235)) / 89 \approx 152 \mu\text{A}$$

Keeping with the same programmed values as the example, Table 2 shows how the average  $I_{DD}$  current is affected by the Wait state time, which is determined by WEN, WTIME, and WLONG. Note that the worst-case current occurs when the Wait state is not enabled.

**Table 2. Average  $I_{DD}$  Current**

WEN	WTIME	WLONG	WAIT STATE	AVERAGE $I_{DD}$ CURRENT
0	n/a	n/a	0 ms	291 $\mu\text{A}$
1	0xFF	0	2.40 ms	280 $\mu\text{A}$
1	0xEE	0	43.2 ms	152 $\mu\text{A}$
1	0x00	0	614 ms	82 $\mu\text{A}$
1	0x00	1	7.37 s	67 $\mu\text{A}$



**TCS3472**  
**COLOR LIGHT-TO-DIGITAL CONVERTER**  
**with IR FILTER**

TAOS135 – AUGUST 2012

**I<sup>2</sup>C Protocol**

Interface and control are accomplished through an I<sup>2</sup>C serial compatible interface (standard or fast mode) to a set of registers that provide access to device control functions and output data. The devices support the 7-bit I<sup>2</sup>C addressing protocol.

The I<sup>2</sup>C standard provides for three types of bus transaction: read, write, and a combined protocol (Figure 10). During a write operation, the first byte written is a command byte followed by data. In a combined protocol, the first byte written is the command byte followed by reading a series of bytes. If a read command is issued, the register address from the previous command will be used for data access. Likewise, if the MSB of the command is not set, the device will write a series of bytes at the address stored in the last valid command with a register address. The command byte contains either control information or a 5-bit register address. The control commands can also be used to clear interrupts.

The I<sup>2</sup>C bus protocol was developed by Philips (now NXP). For a complete description of the I<sup>2</sup>C protocol, please review the NXP I<sup>2</sup>C design specification at <http://www.i2c-bus.org/references/>.

- A** Acknowledge (0)
- N** Not Acknowledged (1)
- P** Stop Condition
- R** Read (1)
- S** Start Condition
- Sr** Repeated Start Condition
- W** Write (0)
- ...** Continuation of protocol
- Master-to-Slave
- Slave-to-Master

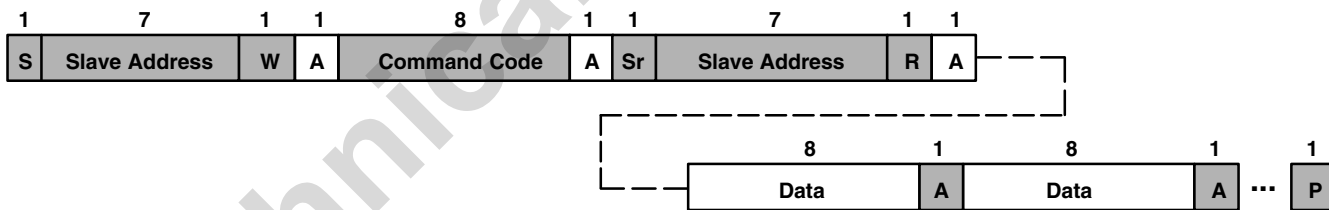
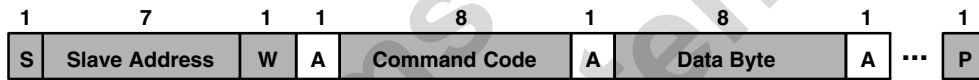

**Figure 10. I<sup>2</sup>C Protocols**

## Register Set

The TCS3472 is controlled and monitored by data registers and a command register accessed through the serial interface. These registers provide for a variety of control functions and can be read to determine results of the ADC conversions. The register set is summarized in Table 3.

**Table 3. Register Address**

ADDRESS	REGISTER NAME	R/W	REGISTER FUNCTION	RESET VALUE
--	COMMAND	W	Specifies register address	0x00
0x00	ENABLE	R/W	Enables states and interrupts	0x00
0x01	ATIME	R/W	RGBC time	0xFF
0x03	WTIME	R/W	Wait time	0xFF
0x04	AILTL	R/W	Clear interrupt low threshold low byte	0x00
0x05	AILTH	R/W	Clear interrupt low threshold high byte	0x00
0x06	AIHTL	R/W	Clear interrupt high threshold low byte	0x00
0x07	AIHTH	R/W	Clear interrupt high threshold high byte	0x00
0x0C	PERS	R/W	Interrupt persistence filter	0x00
0x0D	CONFIG	R/W	Configuration	0x00
0x0F	CONTROL	R/W	Control	0x00
0x12	ID	R	Device ID	ID
0x13	STATUS	R	Device status	0x00
0x14	CDATAL	R	Clear data low byte	0x00
0x15	CDATAH	R	Clear data high byte	0x00
0x16	RDATAL	R	Red data low byte	0x00
0x17	RDATAH	R	Red data high byte	0x00
0x18	GDATAL	R	Green data low byte	0x00
0x19	GDATAH	R	Green data high byte	0x00
0x1A	BDATAL	R	Blue data low byte	0x00
0x1B	BDATAH	R	Blue data high byte	0x00

The mechanics of accessing a specific register depends on the specific protocol used. See the section on I<sup>2</sup>C protocols on the previous pages. In general, the COMMAND register is written first to specify the specific control-status-data register for subsequent read/write operations.



**TCS3472**  
**COLOR LIGHT-TO-DIGITAL CONVERTER**  
**with IR FILTER**

TAOS135 – AUGUST 2012

**Command Register**

The command register specifies the address of the target register for future write and read operations.

**Table 4. Command Register**

		7	6	5	4	3	2	1	0	
COMMAND	CMD	TYPE						ADDR/SF		--
FIELD	BITS	DESCRIPTION								
CMD	7	Select Command Register. Must write as 1 when addressing COMMAND register.								
TYPE	6:5	Selects type of transaction to follow in subsequent data transfers:								
		FIELD VALUE	INTEGRATION TIME							
		00	Repeated byte protocol transaction							
		01	Auto-increment protocol transaction							
		10	Reserved — Do not use							
		11	Special function — See description below							
		Byte protocol will repeatedly read the same register with each data access. Block protocol will provide auto-increment function to read successive bytes.								
ADDR/SF	4:0	Address field/special function field. Depending on the transaction type, see above, this field either specifies a special function command or selects the specific control-status-data register for subsequent read and write transactions. The field values listed below only apply to special function commands:								
		FIELD VALUE	READ VALUE							
		00110	Clear channel interrupt clear							
		other	Reserved — Do not write							
		The Clear channel interrupt clear special function clears any pending interrupt and is self-clearing.								

## Enable Register (0x00)

The Enable register is used primarily to power the TCS3472 device on and off, and enable functions and interrupts as shown in Table 5.

**Table 5. Enable Register**

	7	6	5	4	3	2	1	0		
<b>ENABLE</b>	Reserved			AIEN	WEN	Reserved		AEN	PON	<b>Address 0x00</b>

FIELD	BITS	DESCRIPTION
Reserved	7:5	Reserved. Write as 0.
AIEN	4	RGBC interrupt enable. When asserted, permits RGBC interrupts to be generated.
WEN	3	Wait enable. This bit activates the wait feature. Writing a 1 activates the wait timer. Writing a 0 disables the wait timer.
Reserved	2	Reserved. Write as 0.
AEN	1	RGBC enable. This bit activates the two-channel ADC. Writing a 1 activates the RGBC. Writing a 0 disables the RGBC.
PON <sup>1,2</sup>	0	Power ON. This bit activates the internal oscillator to permit the timers and ADC channels to operate. Writing a 1 activates the oscillator. Writing a 0 disables the oscillator.

- NOTES: 1. See Power Management section for more information.  
2. A minimum interval of 2.4 ms must pass after PON is asserted before an RGBC can be initiated.



**TCS3472**  
**COLOR LIGHT-TO-DIGITAL CONVERTER**  
**with IR FILTER**

TAOS135 – AUGUST 2012

**RGBC Timing Register (0x01)**

The RGBC timing register controls the internal integration time of the RGBC clear and IR channel ADCs in 2.4-ms increments. Max RGBC Count = (256 – ATIME) × 1024 up to a maximum of 65535.

**Table 6. RGBC Timing Register**

FIELD	BITS	DESCRIPTION			
		VALUE	INTEG_CYCLES	TIME	MAX COUNT
ATIME	7:0	0xFF	1	2.4 ms	1024
		0xF6	10	24 ms	10240
		0xD5	42	101 ms	43008
		0xC0	64	154 ms	65535
		0x00	256	700 ms	65535

**Wait Time Register (0x03)**

Wait time is set 2.4 ms increments unless the WLONG bit is asserted, in which case the wait times are 12× longer. WTIME is programmed as a 2's complement number.

**Table 7. Wait Time Register**

FIELD	BITS	DESCRIPTION			
		REGISTER VALUE	WAIT TIME	TIME (WLONG = 0)	TIME (WLONG = 1)
WTIME	7:0	0xFF	1	2.4 ms	0.029 sec
		0xAB	85	204 ms	2.45 sec
		0x00	256	614 ms	7.4 sec

### RGBC Interrupt Threshold Registers (0x04 – 0x07)

The RGBC interrupt threshold registers provides the values to be used as the high and low trigger points for the comparison function for interrupt generation. If the value generated by the clear channel crosses below the lower threshold specified, or above the higher threshold, an interrupt is asserted on the interrupt pin.

**Table 8. RGBC Interrupt Threshold Registers**

REGISTER	ADDRESS	BITS	DESCRIPTION
AILTL	0x04	7:0	RGBC clear channel low threshold lower byte
AILTH	0x05	7:0	RGBC clear channel low threshold upper byte
AIHTL	0x06	7:0	RGBC clear channel high threshold lower byte
AIHTH	0x07	7:0	RGBC clear channel high threshold upper byte

### Persistence Register (0x0C)

The persistence register controls the filtering interrupt capabilities of the device. Configurable filtering is provided to allow interrupts to be generated after each integration cycle or if the integration has produced a result that is outside of the values specified by the threshold register for some specified amount of time.

**Table 9. Persistence Register**

	7	6	5	4	3	2	1	0	Address 0x0C
PERS	Reserved						APERS		
FIELD	BITS		DESCRIPTION						
PPERS	7:4		Reserved						
APERS	3:0		Interrupt persistence. Controls rate of interrupt to the host processor.						
			FIELD VALUE	MEANING	INTERRUPT PERSISTENCE FUNCTION				
			0000	Every	Every RGBC cycle generates an interrupt				
			0001	1	1 clear channel value outside of threshold range				
			0010	2	2 clear channel consecutive values out of range				
			0011	3	3 clear channel consecutive values out of range				
			0100	5	5 clear channel consecutive values out of range				
			0101	10	10 clear channel consecutive values out of range				
			0110	15	15 clear channel consecutive values out of range				
			0111	20	20 clear channel consecutive values out of range				
			1000	25	25 clear channel consecutive values out of range				
			1001	30	30 clear channel consecutive values out of range				
			1010	35	35 clear channel consecutive values out of range				
			1011	40	40 clear channel consecutive values out of range				
			1100	45	45 clear channel consecutive values out of range				
1101	50	50 clear channel consecutive values out of range							
1110	55	55 clear channel consecutive values out of range							
1111	60	60 clear channel consecutive values out of range							

**TCS3472**  
**COLOR LIGHT-TO-DIGITAL CONVERTER**  
**with IR FILTER**

TAOS135 – AUGUST 2012

**Configuration Register (0x0D)**

The configuration register sets the wait long time.

**Table 10. Configuration Register**

	7	6	5	4	3	2	1	0	
CONFIG	Reserved						WLONG	Reserved	Address 0x0D
FIELD	BITS		DESCRIPTION						
Reserved	7:2		Reserved. Write as 0.						
WLONG	1		Wait Long. When asserted, the wait cycles are increased by a factor 12X from that programmed in the WTIME register.						
Reserved	0		Reserved. Write as 0.						

**Control Register (0x0F)**

The Control register provides eight bits of miscellaneous control to the analog block. These bits typically control functions such as gain settings and/or diode selection.

**Table 11. Control Register**

	7	6	5	4	3	2	1	0	
CONTROL	Reserved						AGAIN	Address 0x0F	
FIELD	BITS		DESCRIPTION						
Reserved	7:2		Reserved. Write bits as 0						
AGAIN	1:0		RGBC Gain Control.						
			FIELD VALUE		RGBC GAIN VALUE				
			00		1X gain				
			01		4X gain				
			10		16X gain				
11		60X gain							

**ID Register (0x12)**

The ID Register provides the value for the part number. The ID register is a read-only register.

**Table 12. ID Register**

	7	6	5	4	3	2	1	0	
ID	ID								Address 0x12
FIELD	BITS		DESCRIPTION						
ID	7:0		Part number identification					0x44 = TCS34721 and TCS34725	
								0x4D = TCS34723 and TCS34727	

## Status Register (0x13)

The Status Register provides the internal status of the device. This register is read only.

**Table 13. Status Register**

	7	6	5	4	3	2	1	0	
<b>STATUS</b>	Reserved			AINT	Reserved			AVALID	Address 0x13

FIELD	BIT	DESCRIPTION
Reserved	7:5	Reserved.
AINT	4	RGBC clear channel Interrupt.
Reserved	3:1	Reserved.
AVALID	0	RGBC Valid. Indicates that the RGBC channels have completed an integration cycle.

## RGBC Channel Data Registers (0x14 – 0x1B)

Clear, red, green, and blue data is stored as 16-bit values. To ensure the data is read correctly, a two-byte read I<sup>2</sup>C transaction should be used with a read word protocol bit set in the command register. With this operation, when the lower byte register is read, the upper eight bits are stored into a shadow register, which is read by a subsequent read to the upper byte. The upper register will read the correct value even if additional ADC integration cycles end between the reading of the lower and upper registers.

**Table 14. ADC Channel Data Registers**

REGISTER	ADDRESS	BITS	DESCRIPTION
CDATA	0x14	7:0	Clear data low byte
CDATAH	0x15	7:0	Clear data high byte
RDATA	0x16	7:0	Red data low byte
RDATAH	0x17	7:0	Red data high byte
GDATA	0x18	7:0	Green data low byte
GDATAH	0x19	7:0	Green data high byte
BDATA	0x1A	7:0	Blue data low byte
BDATAH	0x1B	7:0	Blue data high byte



**APPLICATION INFORMATION: HARDWARE**

**PCB Pad Layout**

Suggested PCB pad layout guidelines for the Dual Flat No-Lead (FN) surface mount package are shown in Figure 11.

Note: Pads can be extended further if hand soldering is needed.

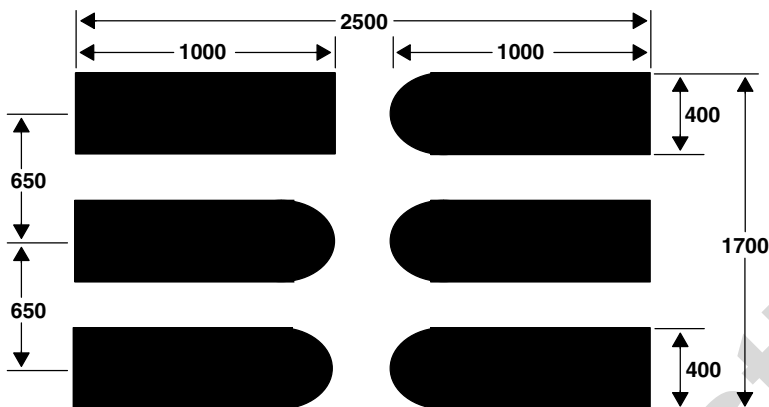

- NOTES: A. All linear dimensions are in micrometers.  
 B. This drawing is subject to change without notice.

**Figure 11. Suggested FN Package PCB Layout**

**PACKAGE INFORMATION**

**PACKAGE FN**

**Dual Flat No-Lead**

**TOP VIEW**

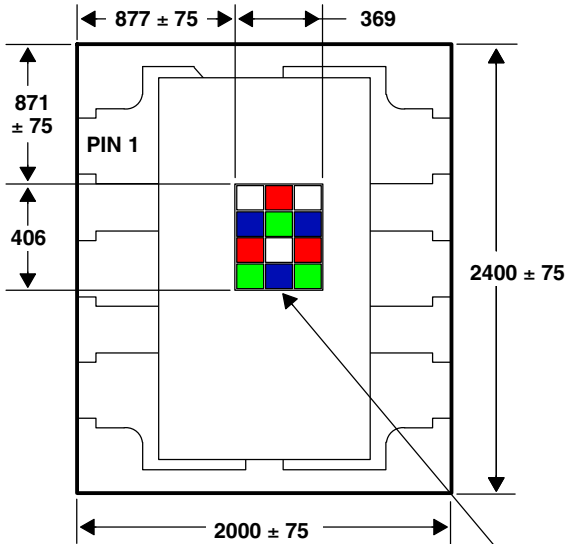

**PIN OUT  
 TOP VIEW**

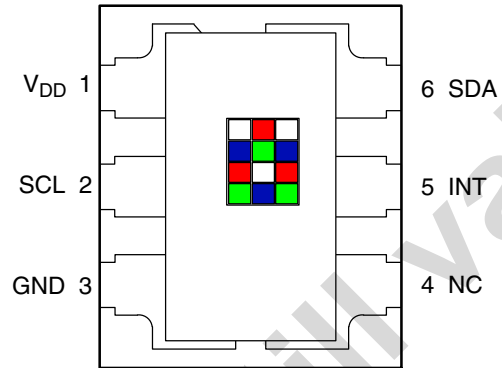

**END VIEW**

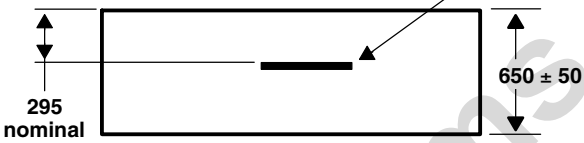

**SIDE VIEW**

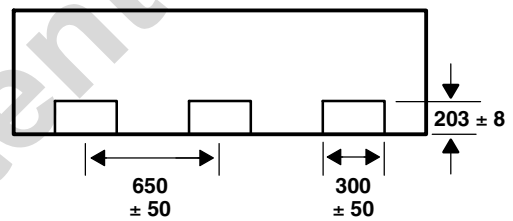

**BOTTOM VIEW**

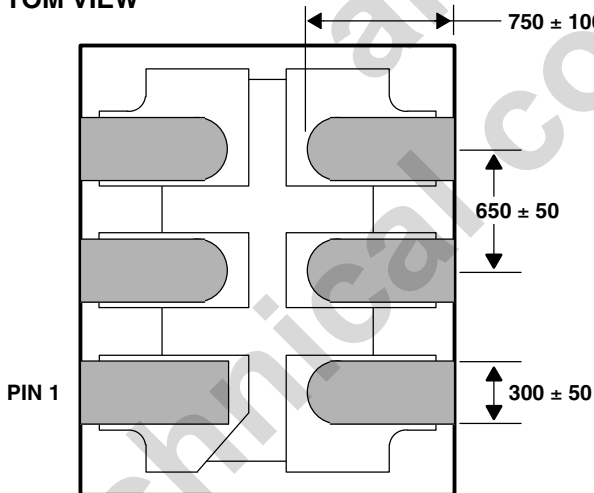

**Lead Free**

- NOTES: A. All linear dimensions are in micrometers. Dimension tolerance is  $\pm 20 \mu\text{m}$  unless otherwise noted.  
 B. The die is centered within the package within a tolerance of  $\pm 3$  mils.  
 C. Package top surface is molded with an electrically nonconductive clear plastic compound having an index of refraction of 1.55.  
 D. Contact finish is copper alloy A194 with pre-plated NiPdAu lead finish.  
 E. This package contains no lead (Pb).  
 F. This drawing is subject to change without notice.

**Figure 12. Package FN — Dual Flat No-Lead Packaging Configuration**



**CARRIER TAPE AND REEL INFORMATION**

**TOP VIEW**

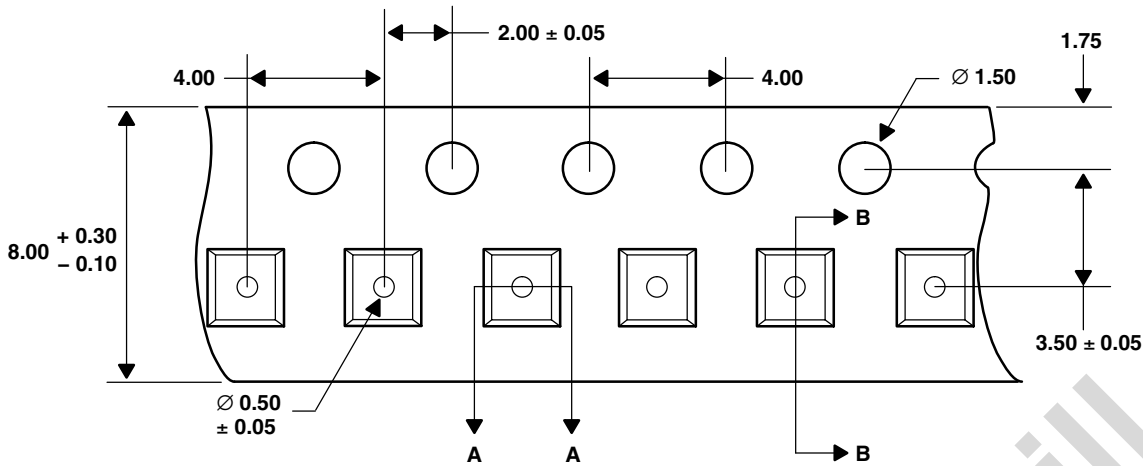

**DETAIL A**

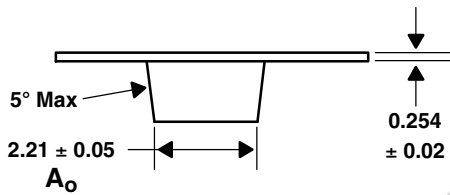

**DETAIL B**

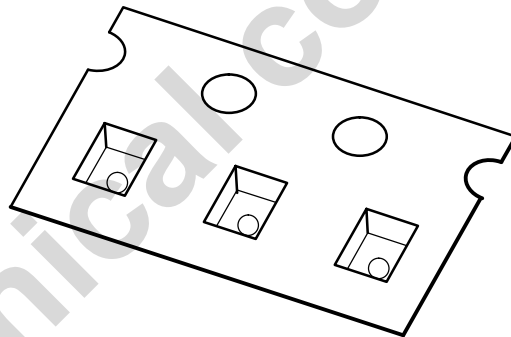
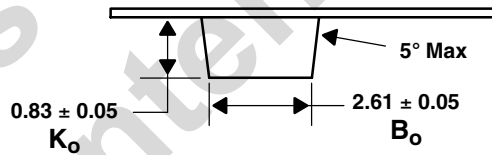

- NOTES: A. All linear dimensions are in millimeters. Dimension tolerance is  $\pm 0.10$  mm unless otherwise noted.  
 B. The dimensions on this drawing are for illustrative purposes only. Dimensions of an actual carrier may vary slightly.  
 C. Symbols on drawing  $A_o$ ,  $B_o$ , and  $K_o$  are defined in ANSI EIA Standard 481-B 2001.  
 D. Each reel is 178 millimeters in diameter and contains 3500 parts.  
 E. TAOS packaging tape and reel conform to the requirements of EIA Standard 481-B.  
 F. In accordance with EIA standard, device pin 1 is located next to the sprocket holes in the tape.  
 G. This drawing is subject to change without notice.

**Figure 13. Package FN Carrier Tape**

### SOLDERING INFORMATION

The FN package has been tested and has demonstrated an ability to be reflow soldered to a PCB substrate. The process, equipment, and materials used in these test are detailed below.

The solder reflow profile describes the expected maximum heat exposure of components during the solder reflow process of product on a PCB. Temperature is measured on top of component. The components should be limited to a maximum of three passes through this solder reflow profile.

**Table 15. Solder Reflow Profile**

PARAMETER	REFERENCE	DEVICE
Average temperature gradient in preheating		2.5°C/sec
Soak time	$t_{\text{soak}}$	2 to 3 minutes
Time above 217°C (T1)	$t_1$	Max 60 sec
Time above 230°C (T2)	$t_2$	Max 50 sec
Time above $T_{\text{peak}} - 10^\circ\text{C}$ (T3)	$t_3$	Max 10 sec
Peak temperature in reflow	$T_{\text{peak}}$	260°C
Temperature gradient in cooling		Max -5°C/sec

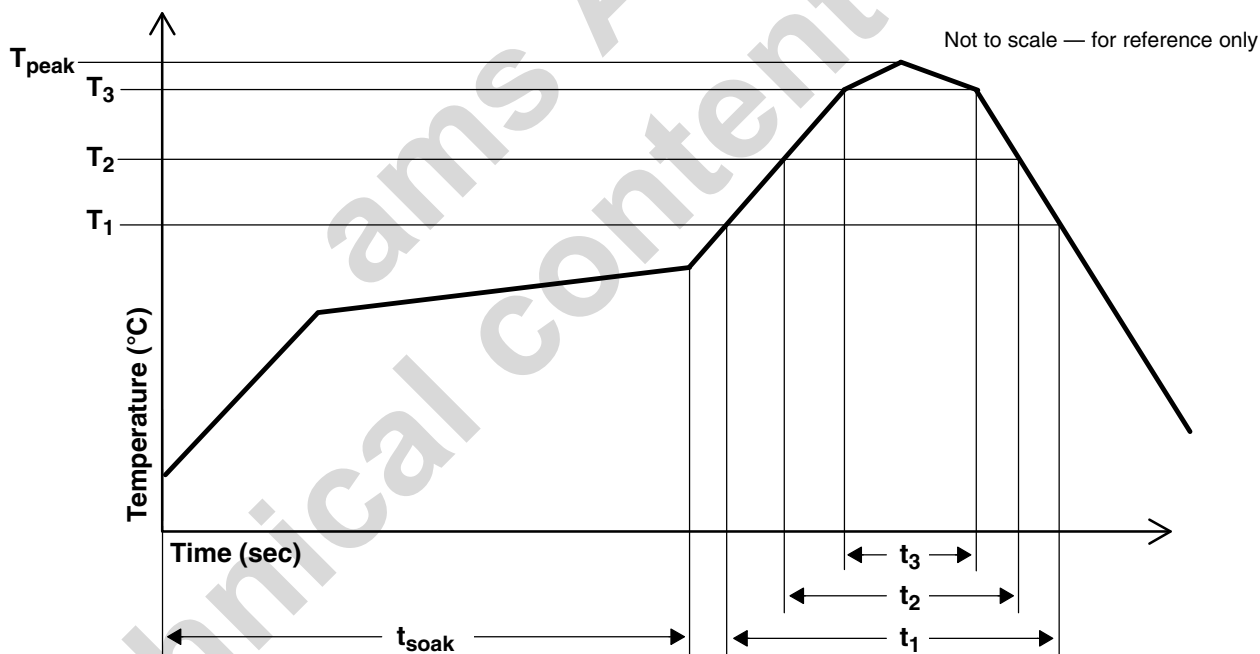

**Figure 14. Solder Reflow Profile Graph**



---

## STORAGE INFORMATION

### Moisture Sensitivity

Optical characteristics of the device can be adversely affected during the soldering process by the release and vaporization of moisture that has been previously absorbed into the package. To ensure the package contains the smallest amount of absorbed moisture possible, each device is dry-baked prior to being packed for shipping. Devices are packed in a sealed aluminized envelope called a moisture barrier bag with silica gel to protect them from ambient moisture during shipping, handling, and storage before use.

The Moisture Barrier Bags should be stored under the following conditions:

Temperature Range	< 40°C
Relative Humidity	< 90%
Total Time	No longer than 12 months from the date code on the aluminized envelope if unopened.

Rebaking of the reel will be required if the devices have been stored unopened for more than 12 months and the Humidity Indicator Card shows the parts to be out of the allowable moisture region.

Opened reels should be used within 168 hours if exposed to the following conditions:

Temperature Range	< 30°C
Relative Humidity	< 60%

If rebaking is required, it should be done at 50°C for 12 hours.

The FN package has been assigned a moisture sensitivity level of MSL 3.

**PRODUCTION DATA** — information in this document is current at publication date. Products conform to specifications in accordance with the terms of Texas Advanced Optoelectronic Solutions, Inc. standard warranty. Production processing does not necessarily include testing of all parameters.

### **LEAD-FREE (Pb-FREE) and GREEN STATEMENT**

**Pb-Free (RoHS)** TAOS' terms *Lead-Free* or *Pb-Free* mean semiconductor products that are compatible with the current RoHS requirements for all 6 substances, including the requirement that lead not exceed 0.1% by weight in homogeneous materials. Where designed to be soldered at high temperatures, TAOS Pb-Free products are suitable for use in specified lead-free processes.

**Green (RoHS & no Sb/Br)** TAOS defines *Green* to mean Pb-Free (RoHS compatible), and free of Bromine (Br) and Antimony (Sb) based flame retardants (Br or Sb do not exceed 0.1% by weight in homogeneous material).

**Important Information and Disclaimer** The information provided in this statement represents TAOS' knowledge and belief as of the date that it is provided. TAOS bases its knowledge and belief on information provided by third parties, and makes no representation or warranty as to the accuracy of such information. Efforts are underway to better integrate information from third parties. TAOS has taken and continues to take reasonable steps to provide representative and accurate information but may not have conducted destructive testing or chemical analysis on incoming materials and chemicals. TAOS and TAOS suppliers consider certain information to be proprietary, and thus CAS numbers and other limited information may not be available for release.

### **NOTICE**

Texas Advanced Optoelectronic Solutions, Inc. (TAOS) reserves the right to make changes to the products contained in this document to improve performance or for any other purpose, or to discontinue them without notice. Customers are advised to contact TAOS to obtain the latest product information before placing orders or designing TAOS products into systems.

TAOS assumes no responsibility for the use of any products or circuits described in this document or customer product design, conveys no license, either expressed or implied, under any patent or other right, and makes no representation that the circuits are free of patent infringement. TAOS further makes no claim as to the suitability of its products for any particular purpose, nor does TAOS assume any liability arising out of the use of any product or circuit, and specifically disclaims any and all liability, including without limitation consequential or incidental damages.

TEXAS ADVANCED OPTOELECTRONIC SOLUTIONS, INC. PRODUCTS ARE NOT DESIGNED OR INTENDED FOR USE IN CRITICAL APPLICATIONS IN WHICH THE FAILURE OR MALFUNCTION OF THE TAOS PRODUCT MAY RESULT IN PERSONAL INJURY OR DEATH. USE OF TAOS PRODUCTS IN LIFE SUPPORT SYSTEMS IS EXPRESSLY UNAUTHORIZED AND ANY SUCH USE BY A CUSTOMER IS COMPLETELY AT THE CUSTOMER'S RISK.

LUMENOLOGY, TAOS, the TAOS logo, and Texas Advanced Optoelectronic Solutions are registered trademarks of Texas Advanced Optoelectronic Solutions Incorporated.

ams AG  
Technical content still valid