

DETAILS

Ordering Number	F13402_ANGELINA-W
Family	ANGELINA
Type	Reflector
Color	metal
Diameter	82 mm
Height	31 mm
Style	round
Optic Material	PC
Holder Material	
Fastening	
Status	ready
ROHS Compliant	Yes
Date Updated	28/04/2014



OPTICAL PROPERTIES

LED	Viewing Angle	Light Beam	Efficiency	cd/lm	connector
PrevaLED Core Z3 LES9	38 degrees		93 %	1.280	Z50 Optic Clip part n r. 2213194-1 TE
CXA1816	39 degrees		94 %	1.280	50-2101CR + Angela(50 -2100AN) IDEAL
NSBxL121A	39 degrees		91 %	1.230	50-2100NC + Angela(50 -2100AN) IDEAL
PrevaLED Core AC (LEP-800)	40 degrees		93 %	1.260	Z50 Optic Clip part n r. 2213194-1 TE
LUXEON CoB 1204/1205	40 degrees		93 %	1.240	50-2100SH + Angela(50 -2100AN) IDEAL
COB 10W/13W/17W/24W	40 degrees		93 %	1.250	50-2100LG + Angela(50 -2100AN) IDEAL
BXRA ES Rectangle	43 degrees		93 %	1.210	50-2100BL + Angela(50 -2100AN) IDEAL
Mega Zenigata (GW6DME)	43 degrees		93 %	1.180	50-2100SH + Angela(50 -2100AN) IDEAL
CLL03x	43 degrees		93 %	1.190	50-2103CT + Angela(50 -2100AN) IDEAL
NSCxJ216A	43 degrees		94 %	1.190	50-2103NC + Angela(50 -2100AN) IDEAL

D

C

B

A

4

4

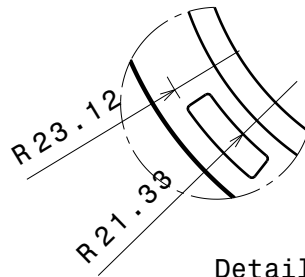
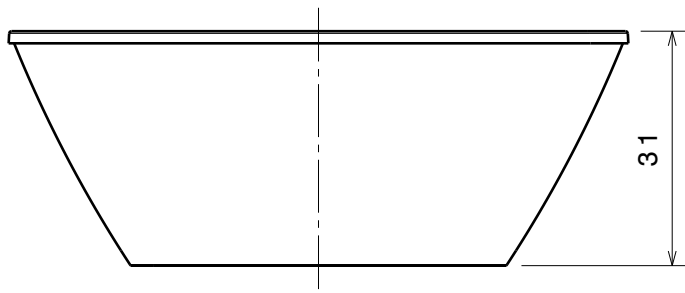

Detail B
Scale: 2:1

3

3

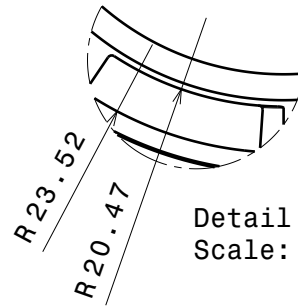
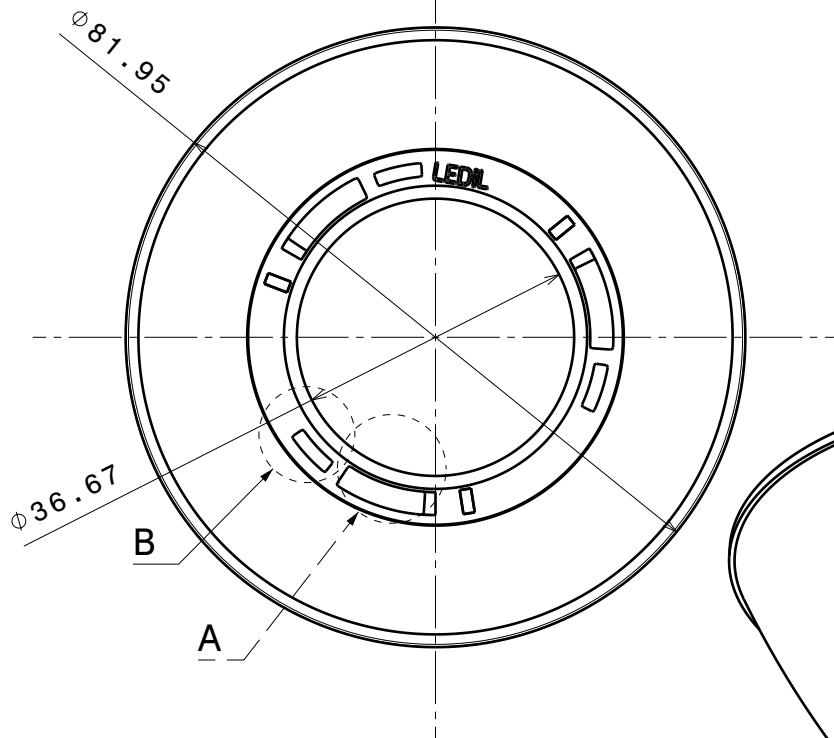

Detail A
Scale: 2:1

2

2

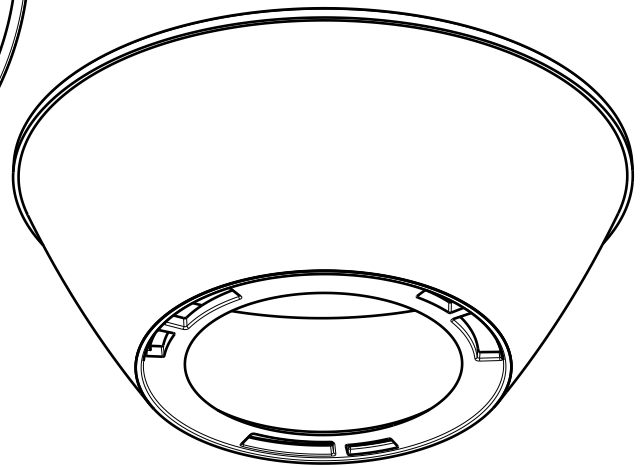

1

1

INDEX	PART NO	DESCRIPTION	MATERIAL	COLOUR
1		ANGELINA	PC	metal

Tolerances if not otherwise shown
According to DIN ISO 2768-1
Linear measures:
Up to 30mm class F, otherwise class M.
According to DIN ISO 2768-2
Form and position: class K



Ledil Oy
Salorankatu 10
FIN 24240 SALO
Finland

THIRD ANGLE PROJECTION:

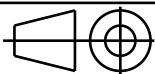

DRAWING TITLE

ANGELINA series Reflector

This drawing is the property of LEDiL Oy. It may not be reproduced, copied or communicated without a written agreement with LEDiL Oy."

SIZE	PART NUMBER
A4	-

SCALE	1:1	WEIGHT	-	SHEET	1/1
-------	-----	--------	---	-------	-----

D

A

Luminaire: LEDiL Oy F13402_ANGELINA-W_(PrevaLED_LES9) Eff. 93%
Lamps: 1 x PrevaLED_LES9_(PL-CORE-1100-830-Z3)_507.9lm@100mA_P=4.5039W_I=100.1mA

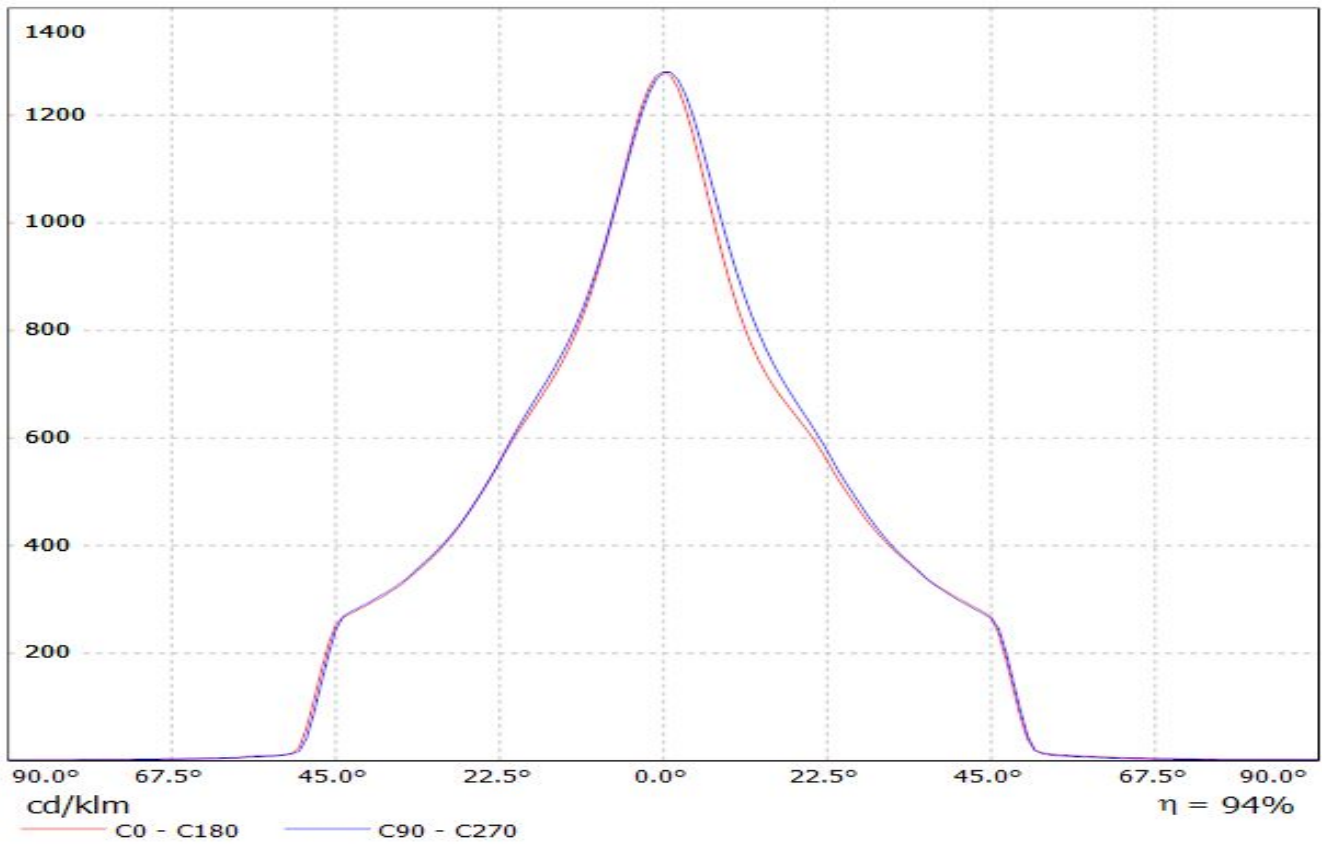

Luminaire: LEDiL Oy F13402_ANGELINA-W_(CXA1816) Eff. 94%
Lamps: 1 x CREE_CXA1816_1042.78lm@250mA_P=8.65157W_I=249.9mA

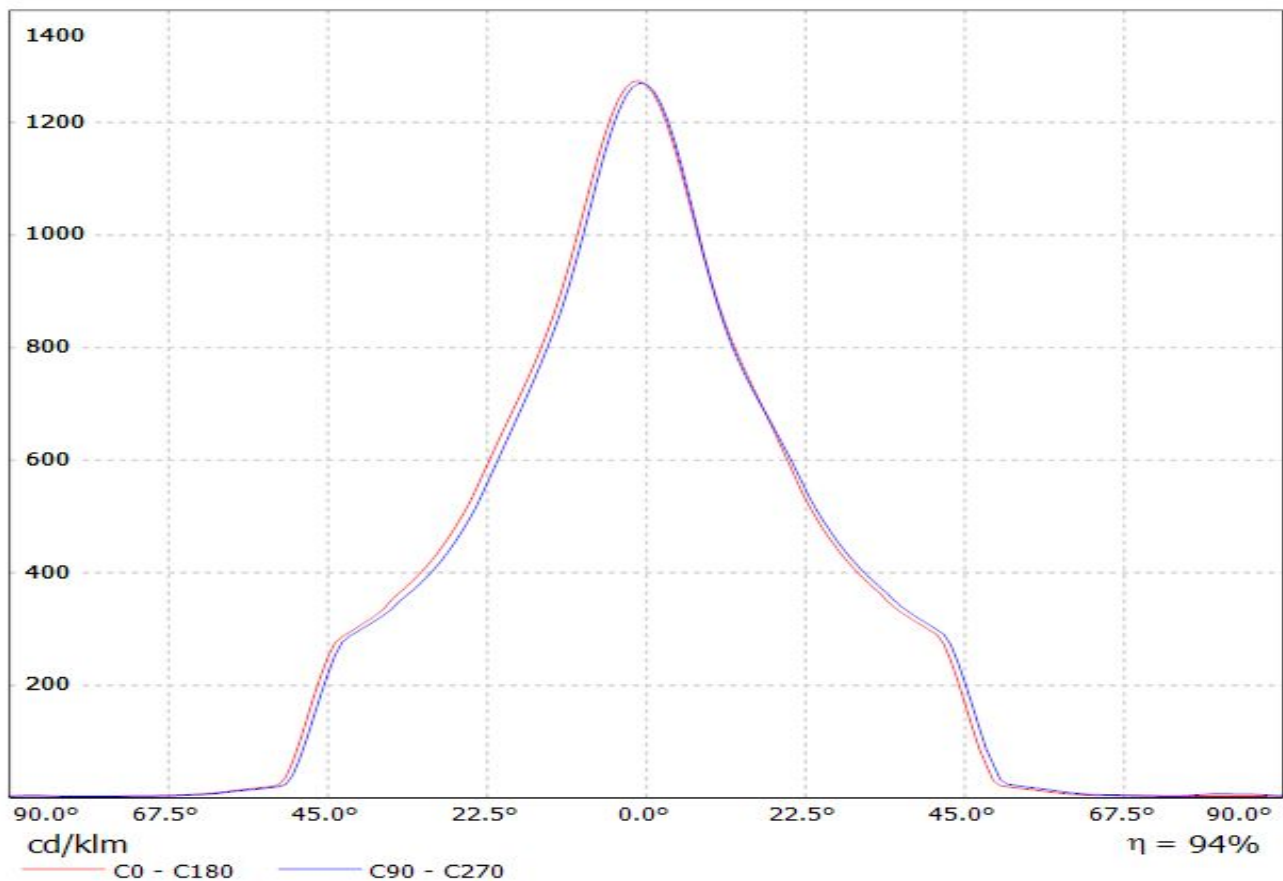

Luminaire: LEDiL Oy F13402_ANGELINA-W_(NSBxL121A) Eff.90.9%
Lamps: 1 x NICHIA_NSBxL121A_(NSBLL121AE)_805.561lm@250mA_CCT=3000K_P=7.3681W_I=249.8mA

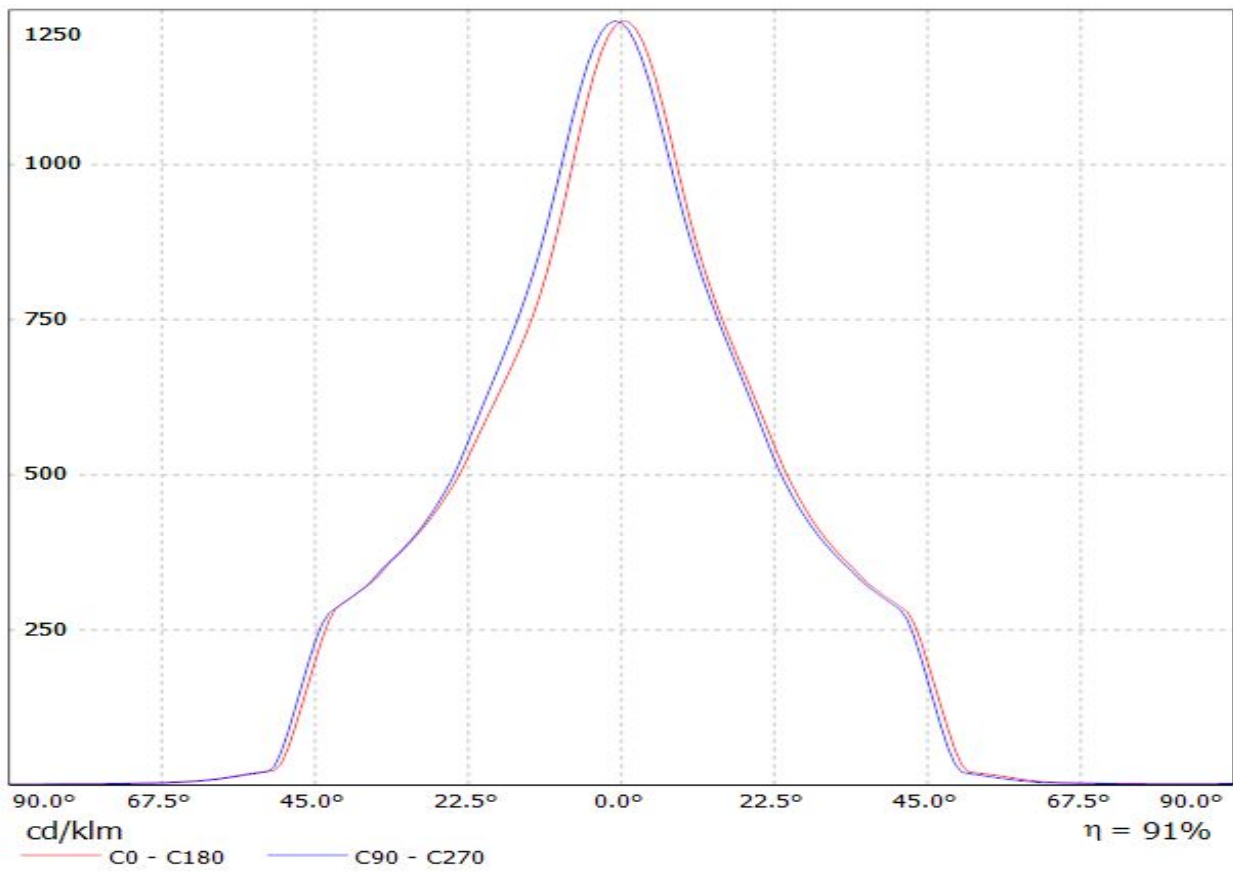

Luminaire: LEDiL Oy F13402_ANGELINA-W (LEP-800-827-C-AC)

Lamps: 1 x OSRAM PrevaLED Core AC (LEP-800-827-C-AC) 910lm@60mA U:230V P:14W

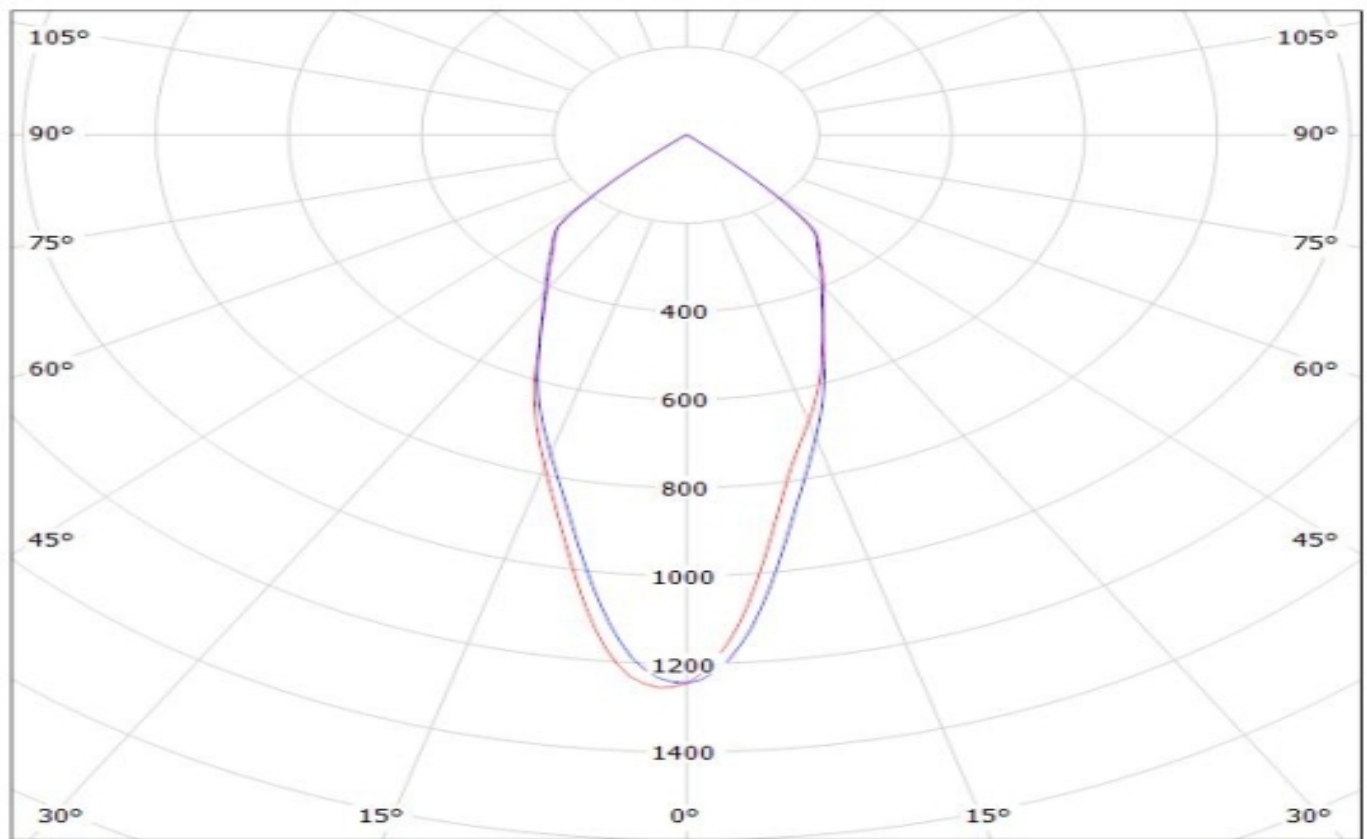

cd/klm
— C0 - C180 — C90 - C270

$\eta = 93\%$

Luminaire: LEDiL Oy F13402_ANGELINA-W_(LUXEON_COB_1205) Eff.93.0%
Lamps: 1 x LUXEON_COB_1205_(LHC1-3080-1205)_1084.49lm@250mA_CCT=3000K_P=8.31784W_I=249.8mA

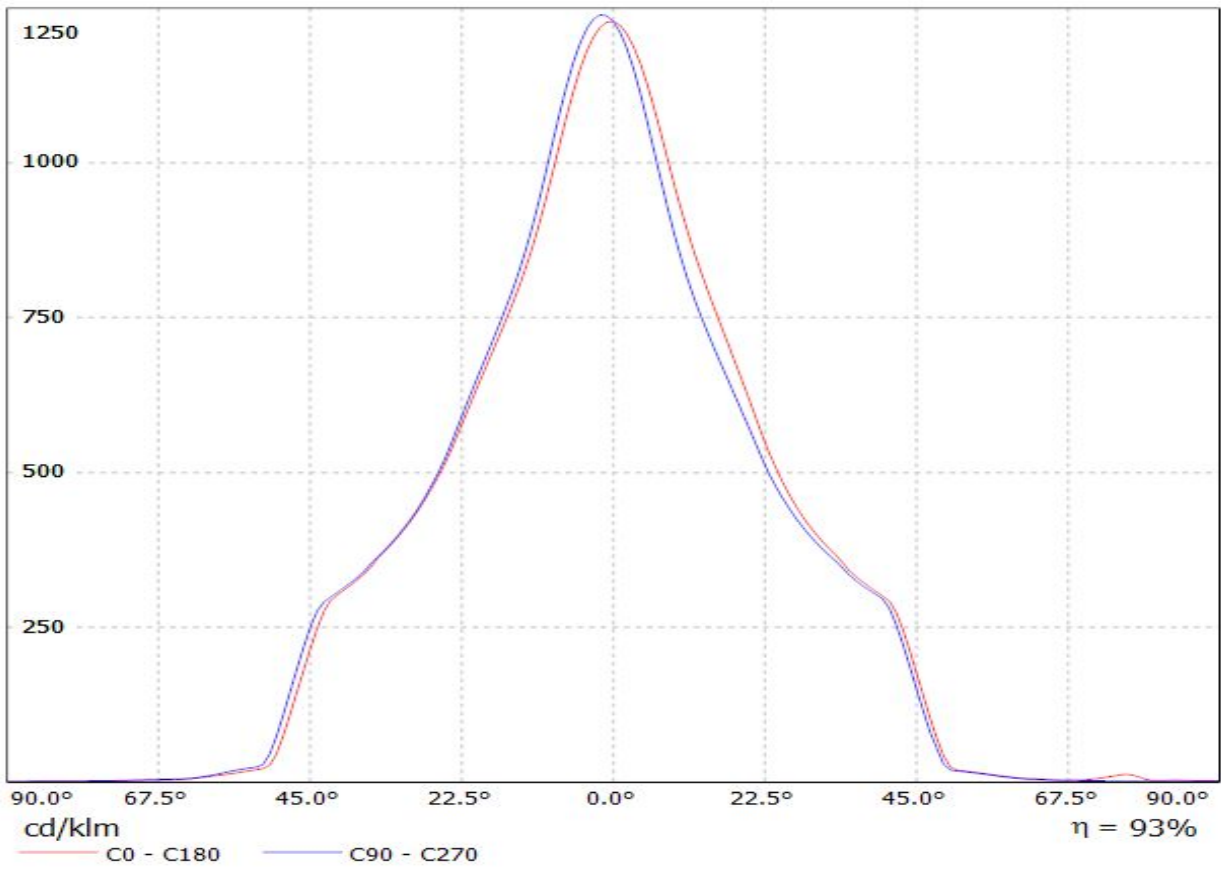

Luminaire: LEDiL Oy F13402_ANGELINA-W_(LG_COB-10W) Eff.93.1%
Lamps: 1 x LG_COB-10W_1024lm@250mA_CCT=5090K_P=9W_I=250mA

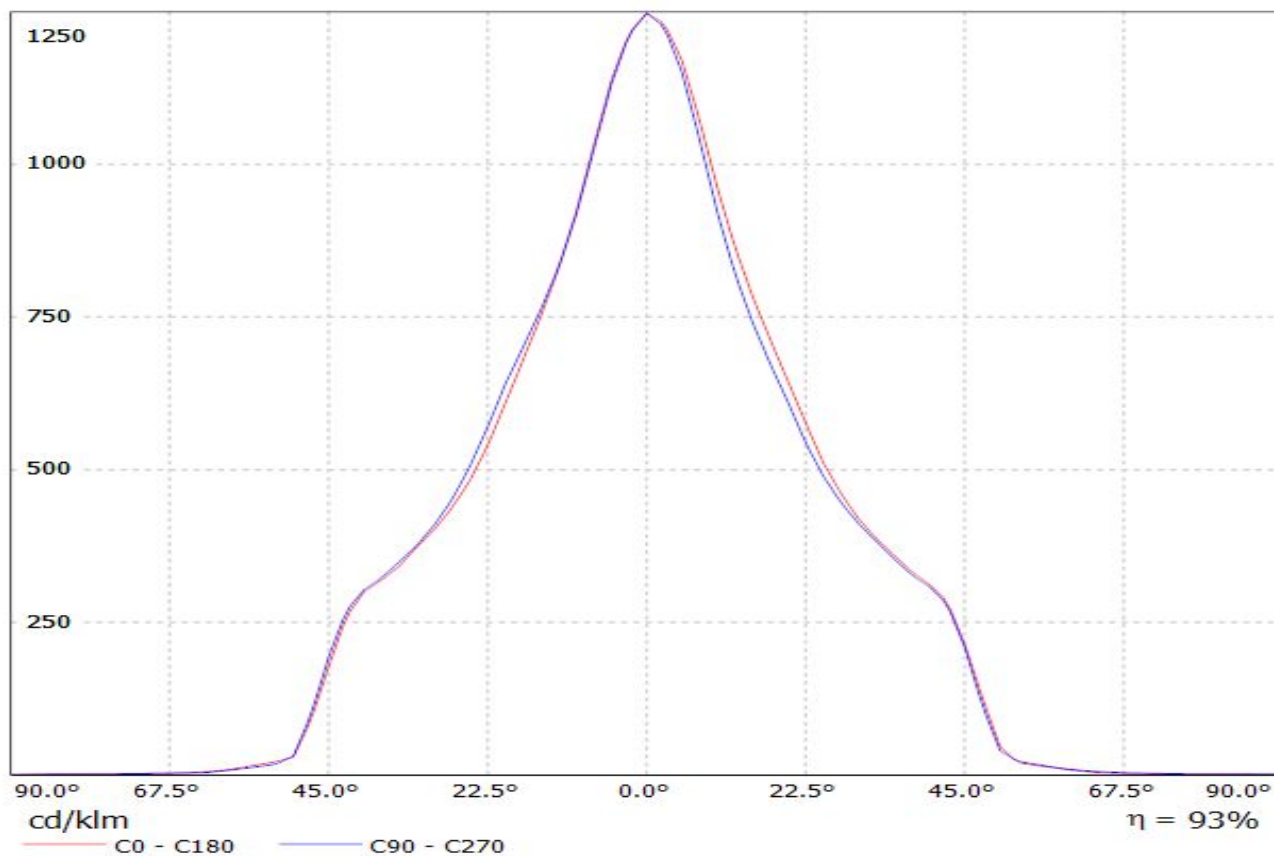

Luminaire: LEDiL Oy F13402_ANGELINA-W_(MEGAZENIGATA) Eff.93.0%
Lamps: 1 x SHARP_MEGAZENIGATA_(GW6DME30NFC)_1238.26lm@250mA_CCT=3000K_P=11.1211W_I=249.8mA

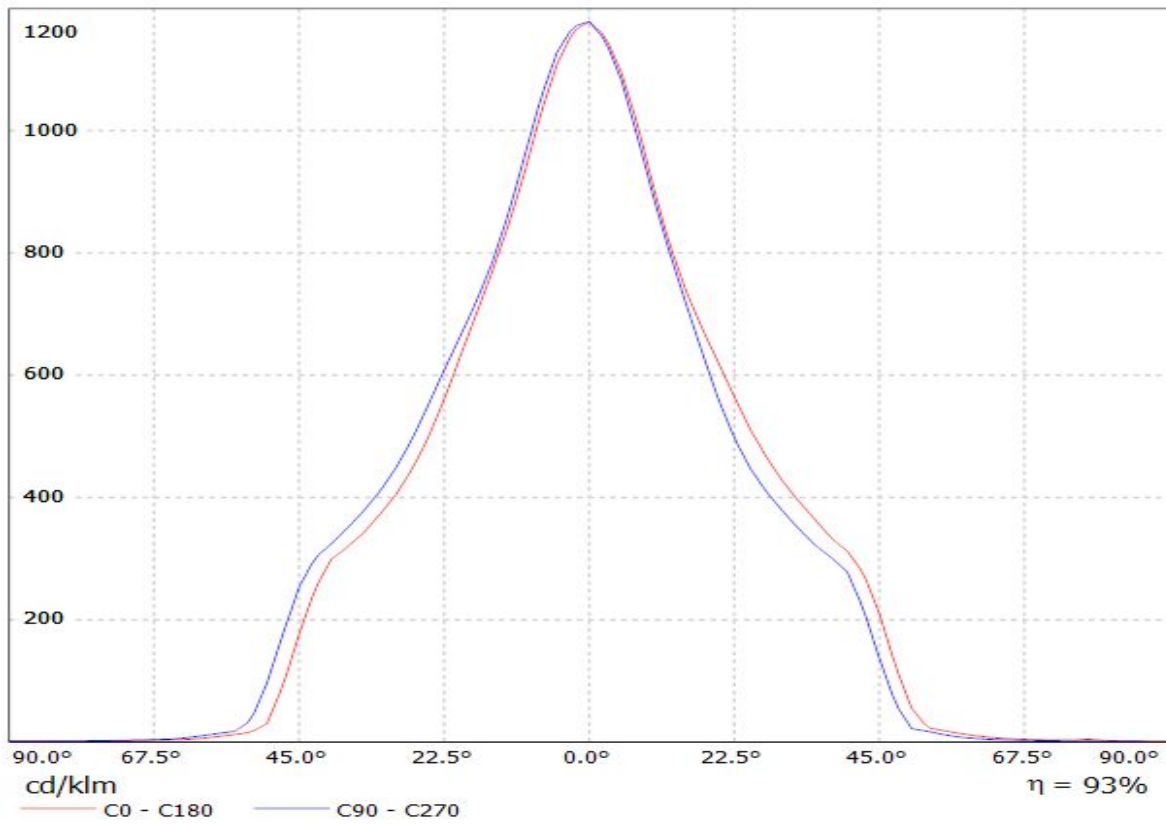

Luminaire: LEDiL Oy F13402_ANGELINA-W_(MEGAZENIGATA) Eff.93.0%
Lamps: 1 x SHARP_MEGAZENIGATA_(GW6DME30NFC)_1238.26lm@250mA_CCT=3000K_P=11.1211W_I=249.8mA

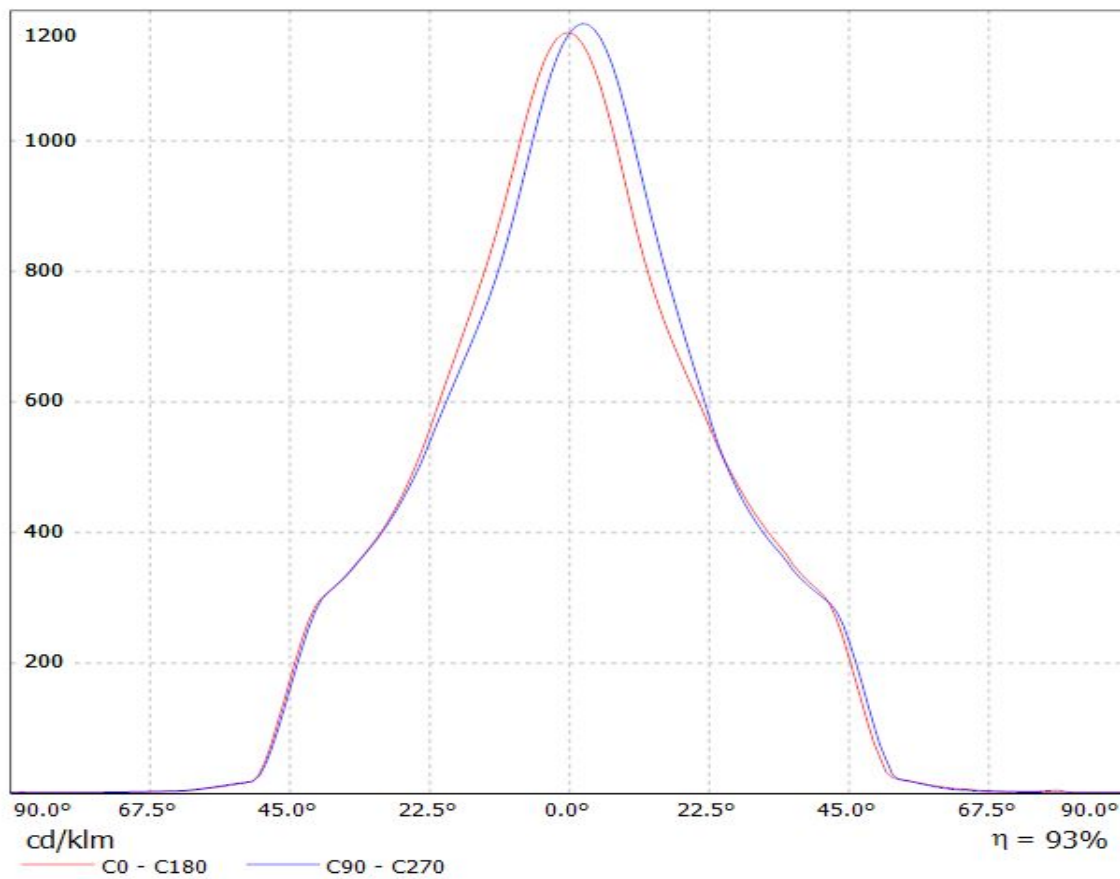

Luminaire: LEDiL Oy F13402_ANGELINA-W_(CLL030) Eff 92.6%

Lamps: 1 x CITIZEN_CLL030_(CLL030-1205A5-303H1A7)_758.588lm@250mA_CCT=5090K_P=8.61086W_I=249.8mA

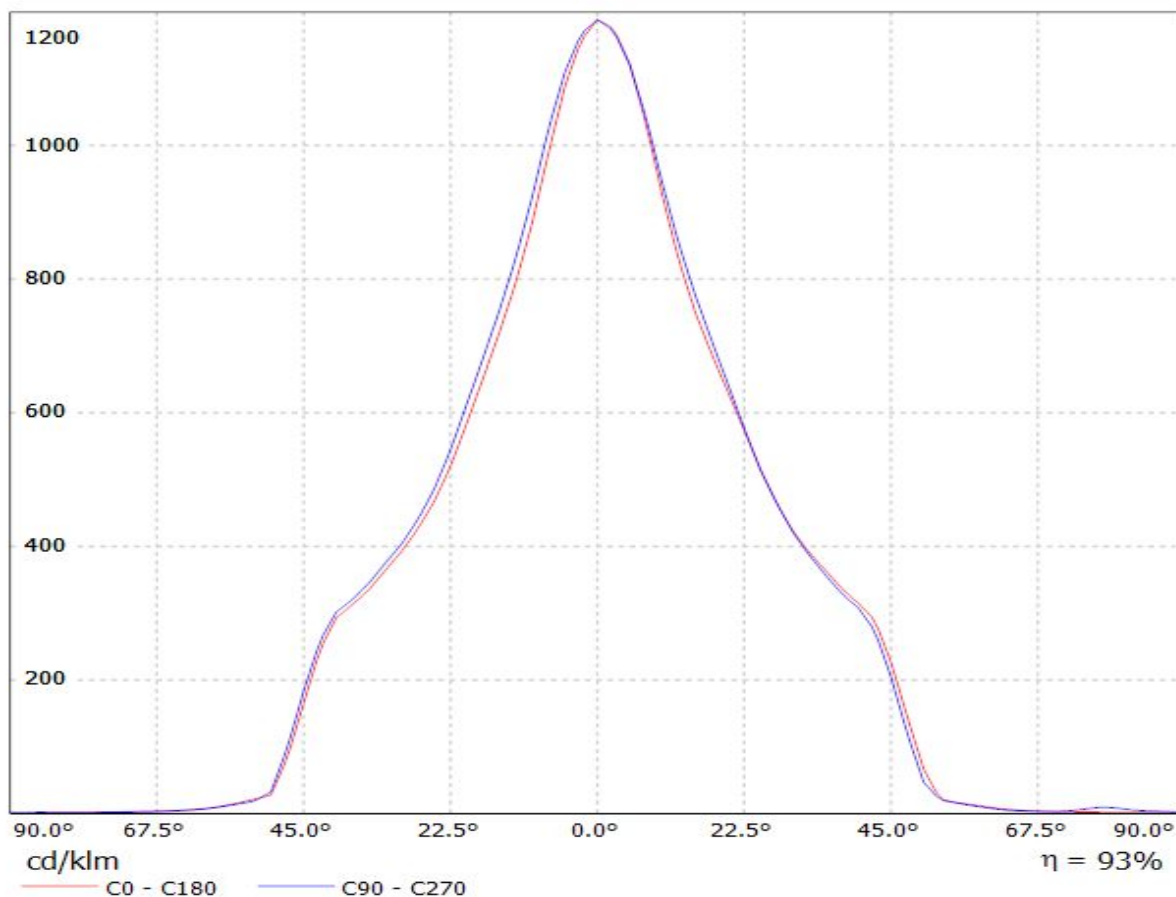

Luminaire: LEDiL Oy F13402_ANGELINA-W_(NSCxJ216A) Eff.93.9%
Lamps: 1 x NICHIA_NSCxJ216A_(NSCLJ216AE)_949.847lm@250mA_CCT=3000K_P=7.96937W_I=249.8mA

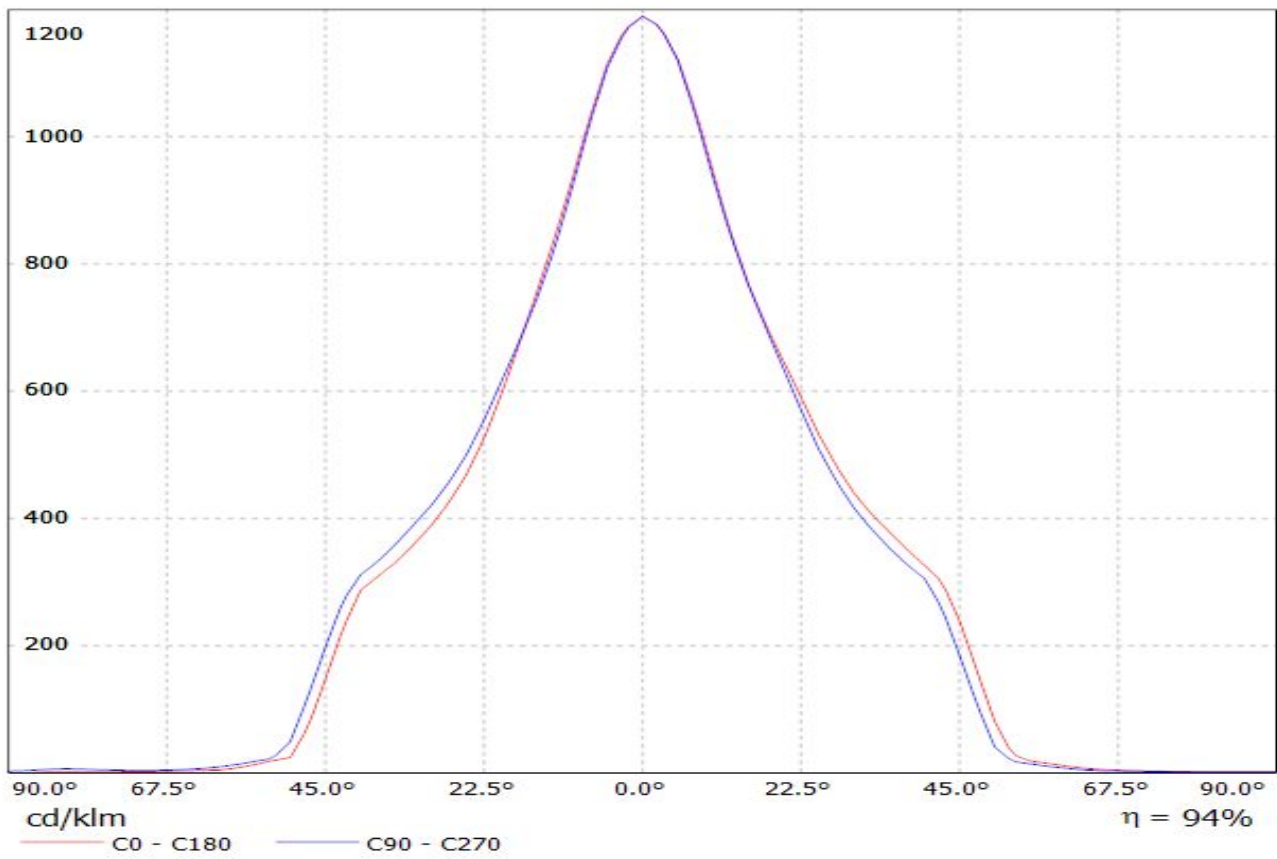

Luminaire: LEDiL Oy F13402_ANGELINA-W_(LUXEON_COB_1208) Eff 93.3%
Lamps: 1 x LUXEON_COB_1208_(LHC1-3080-1208)_1015.13lm@250mA_CCT=3000K_P=8.15972W_I=249.8mA

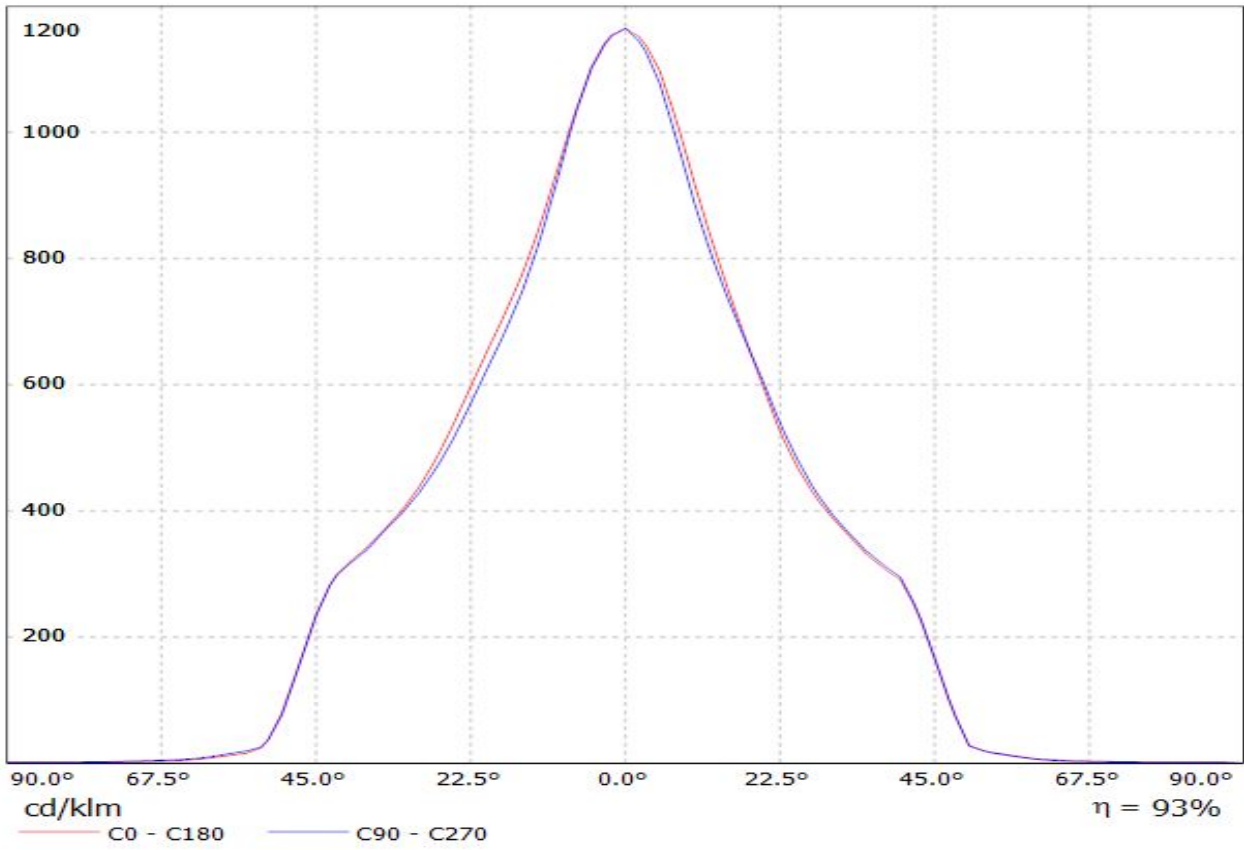

LEDiL Oy C13402_ANGELINA-W_(LUXEON_K12) Eff.94.0% / LDC (Linear)

Luminaire: LEDiL Oy C13402_ANGELINA-W_(LUXEON_K12) Eff.94.0%
Lamps: 1 x LUXEON_K12 (929.543lm@250mA)

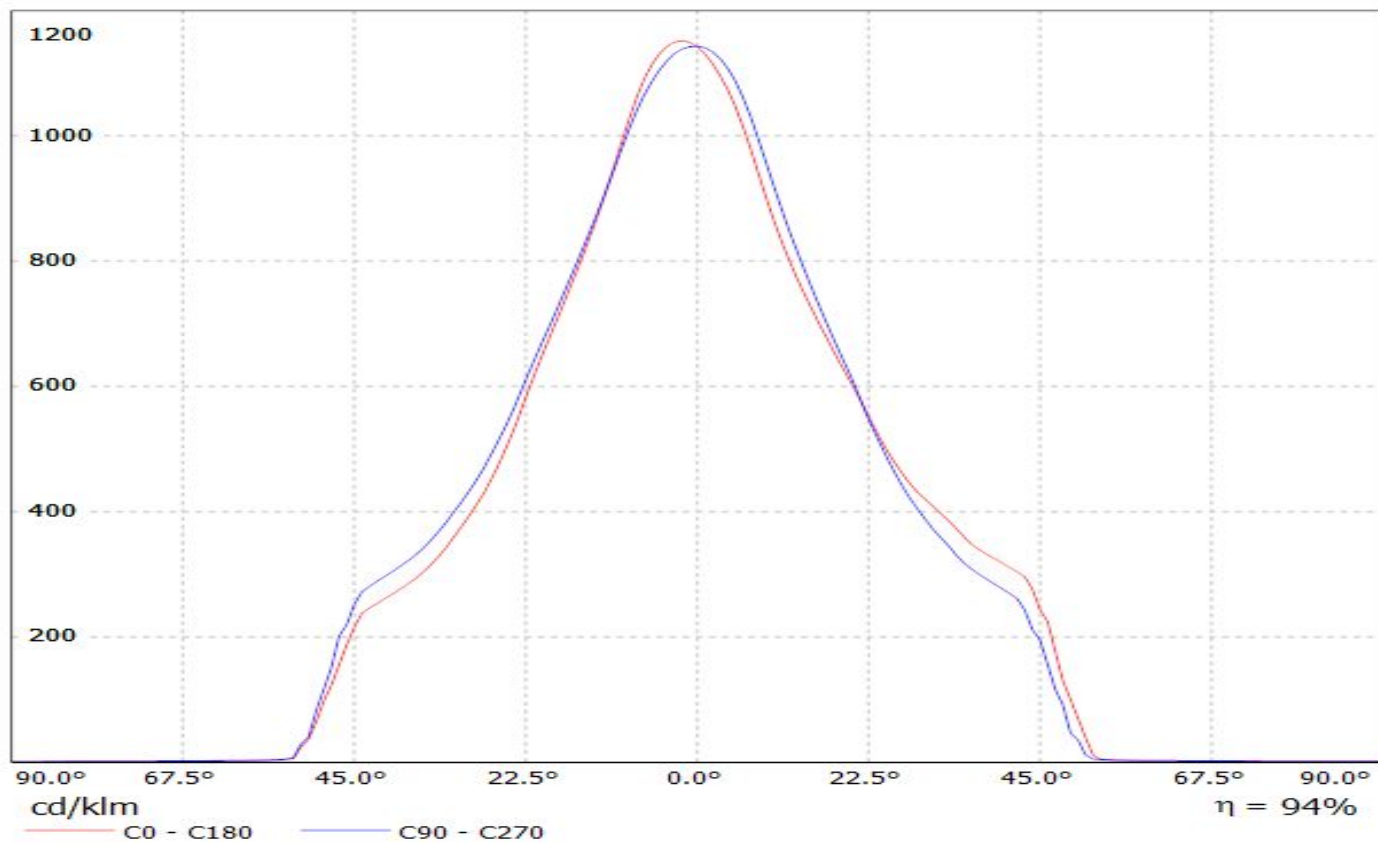

Luminaire: LEDiL Oy F13402_ANGELINA-W_(LUXEON_CoB_1205) Eff: 94 %
Lamps: 1 x LUXEON CoB 1205 (LHC1-3080-1205) 1082lm@250mA CCT=3000K P=8.3W I=250mA

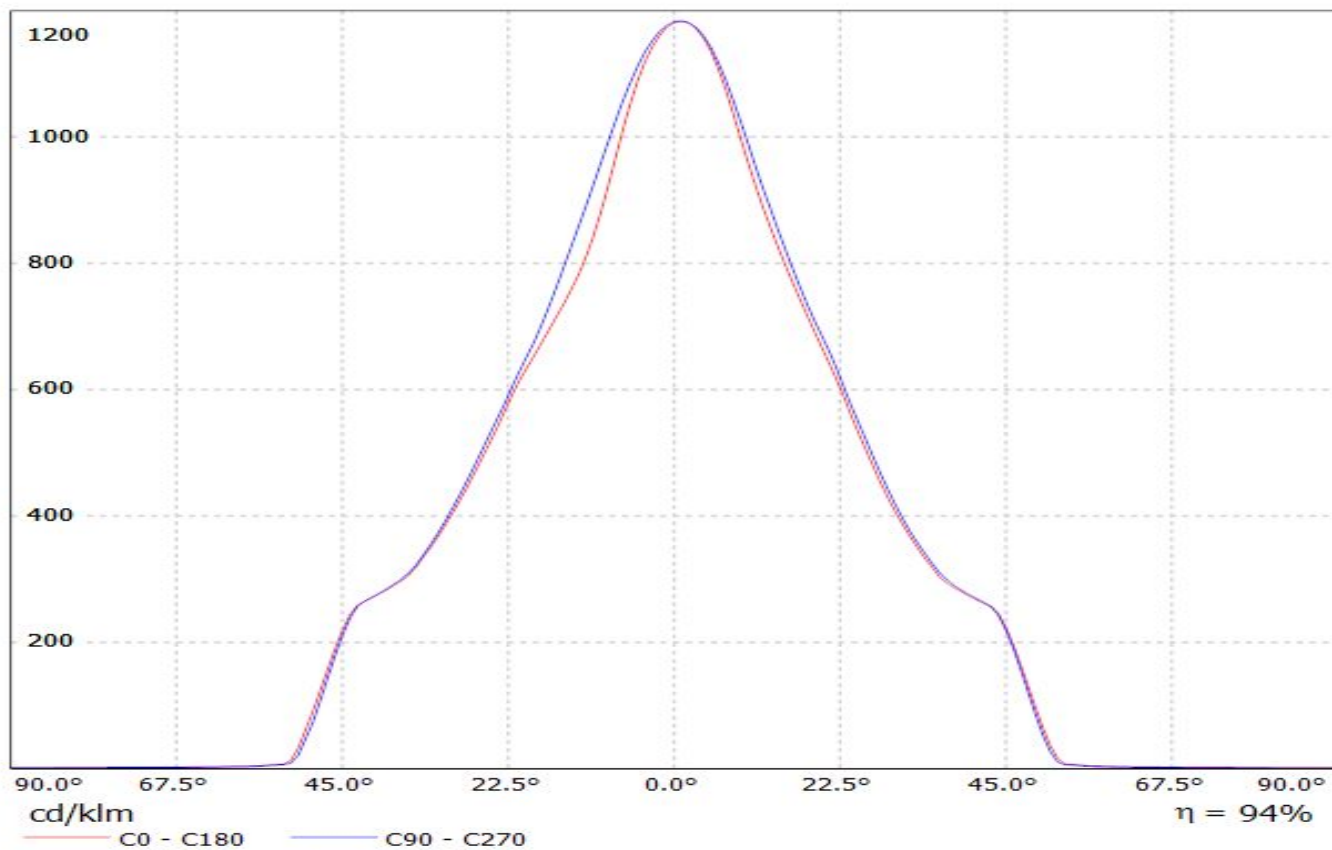

Luminaire: LEDil Oy F13402_ANGELINA-W_(Soleriq_S13) Efficiency=94%
Lamps: 1 x Osram Soleriq S13 (GW KAGHB1.EM) 855lm @ 250mA CCT=3100K P=7.5W I=250mA

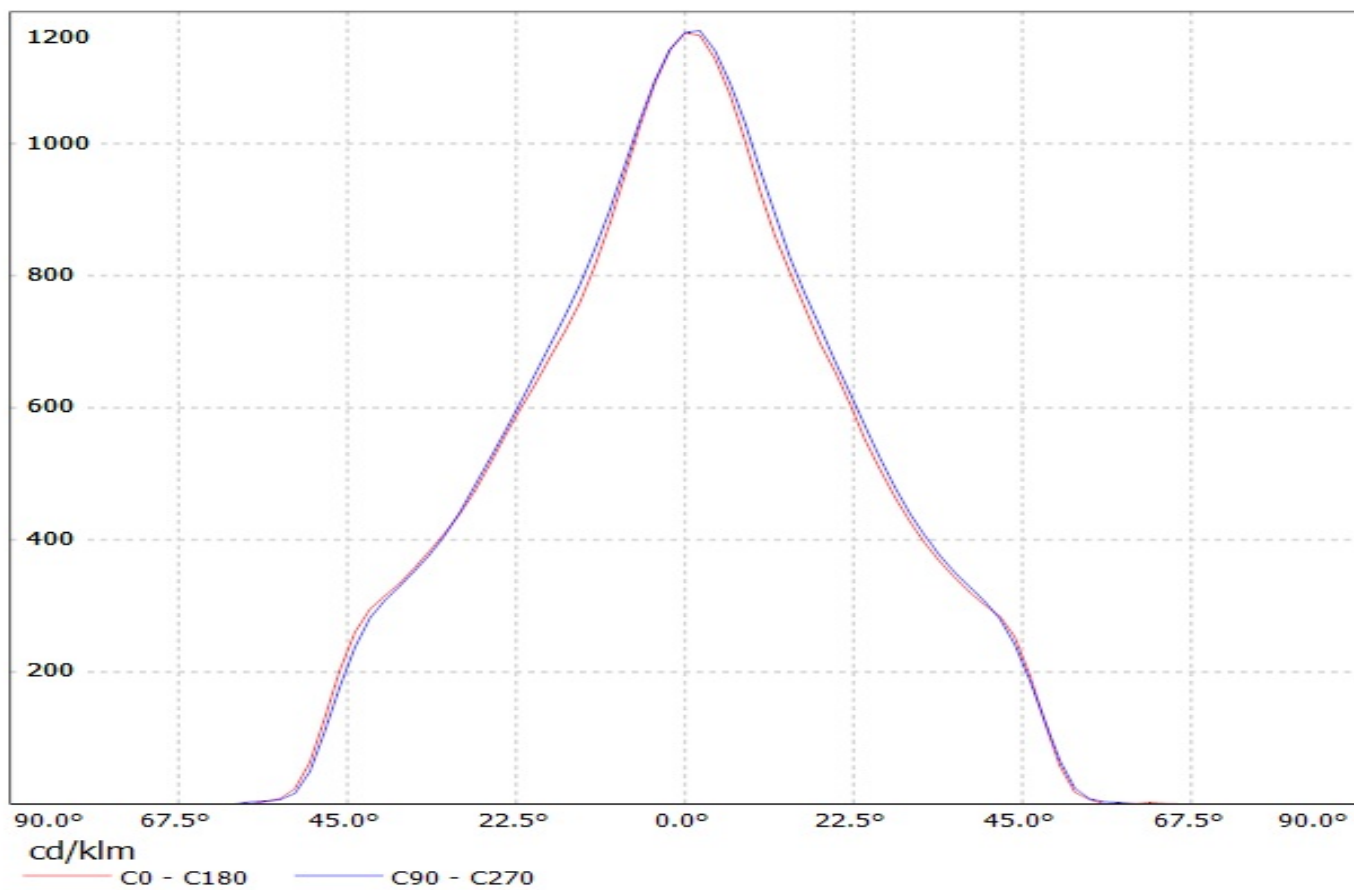

Luminaire: LEDiL Oy F13402_ANGELINA-W_(MegaZenigata) Eff.92.3%
Lamps: 1 x MegaZenigata_GW6DME (518.495lm@100mA)

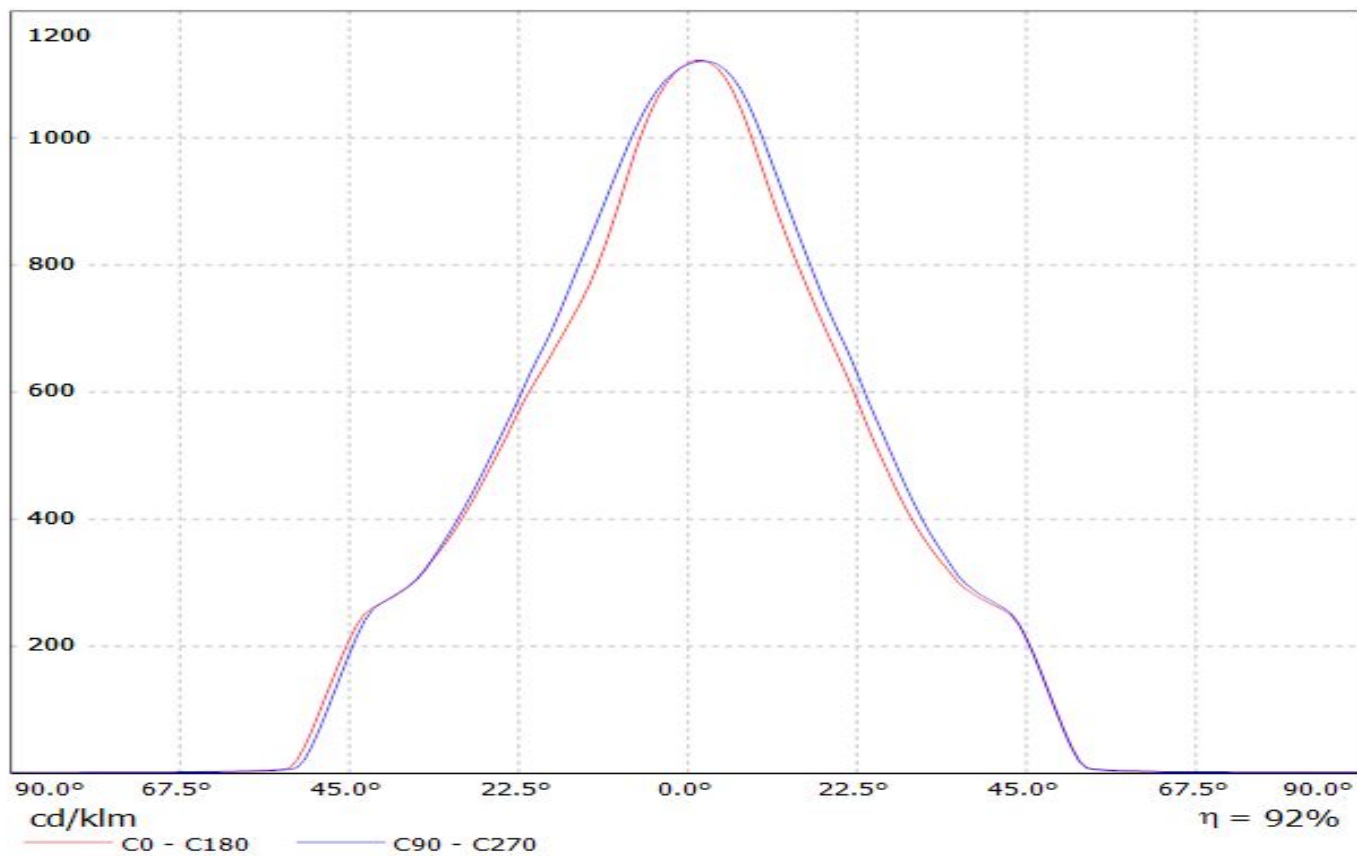

Luminaire: LEDiL Oy F13402_ANGELINA-W_(PrevaLED_Z4) Eff. 93%
Lamps: 1 x Osram_PrevaLED_CORE_Z4_(PL-CORE-3000-830-Z4)_1423.93lm@250mA_P=10.7652W_I=249.9mA

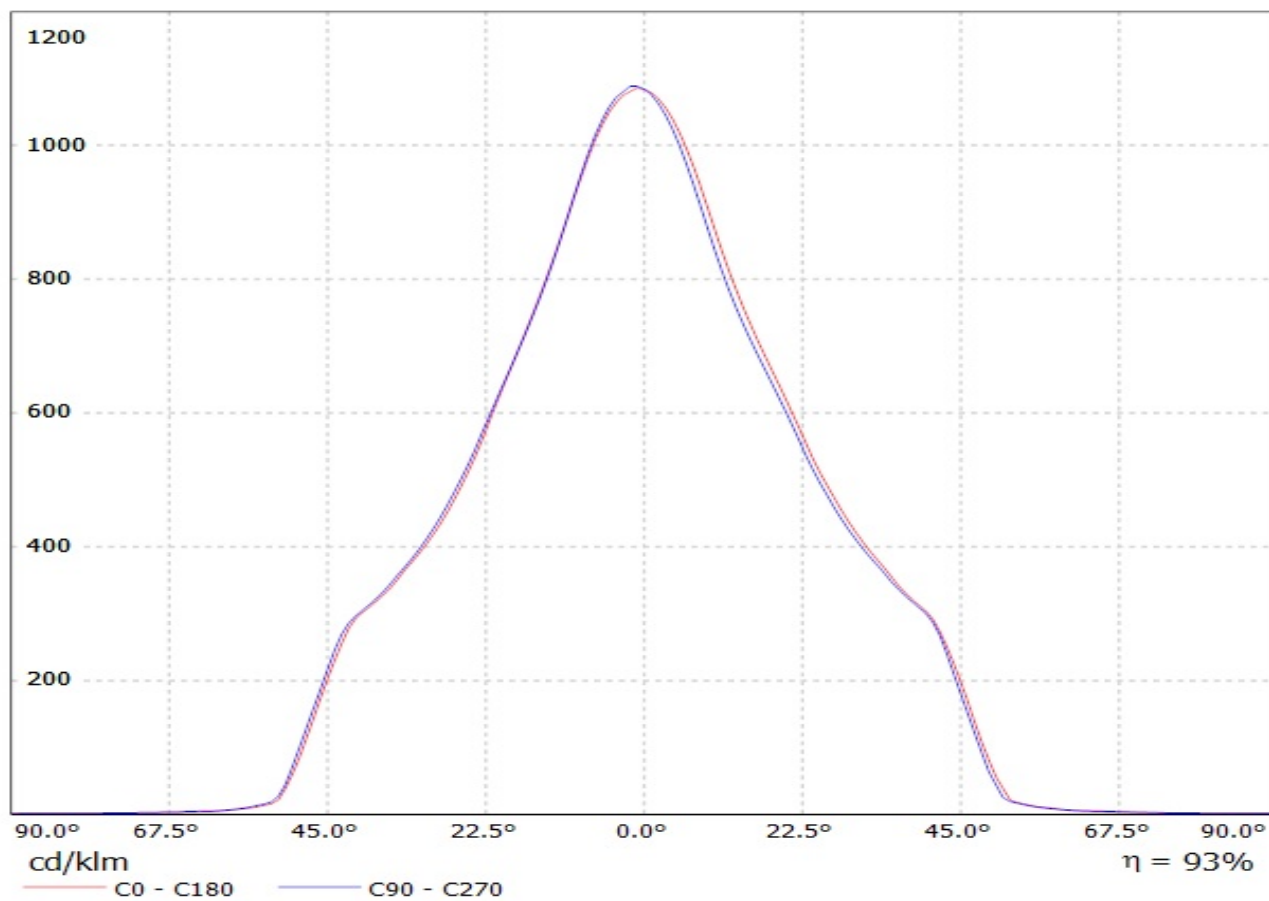

Luminaire: LEDiL Oy F13402_ANGELINA-W_(CXA25) Eff.93.9%
Lamps: 1 x CREE_CXA25_(CXA2530-7C0-T2-N0H)_1151.98lm@250mA_CCT=3000K_P=8.4892W_I=249.8mA

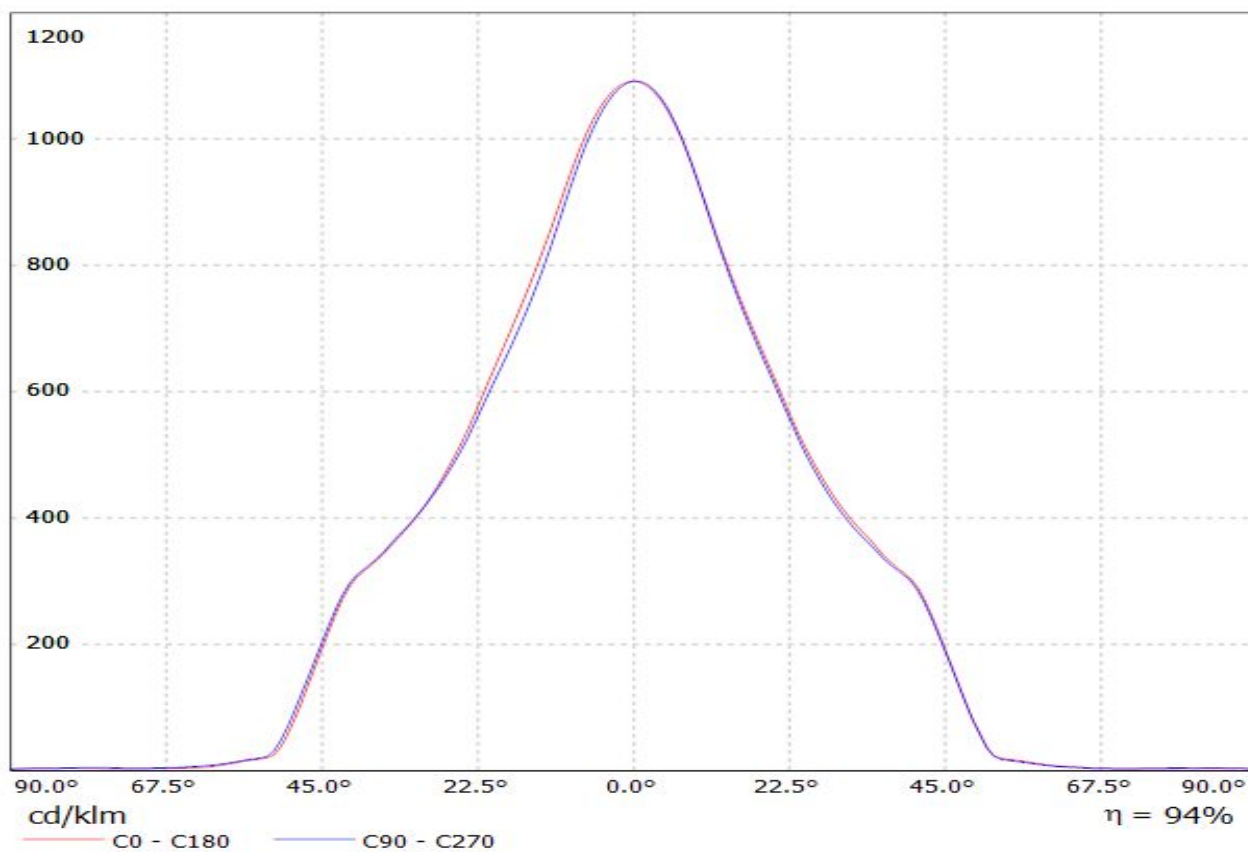

LEDiL Oy C13402_ANGELINA-W_(LUXEON_K16) Eff.93.7% / LDC (Linear)

Luminaire: LEDiL Oy C13402_ANGELINA-W_(LUXEON_K16) Eff.93.7%
Lamps: 1 x LUXEON_K16 (1204.33lm@250mA)

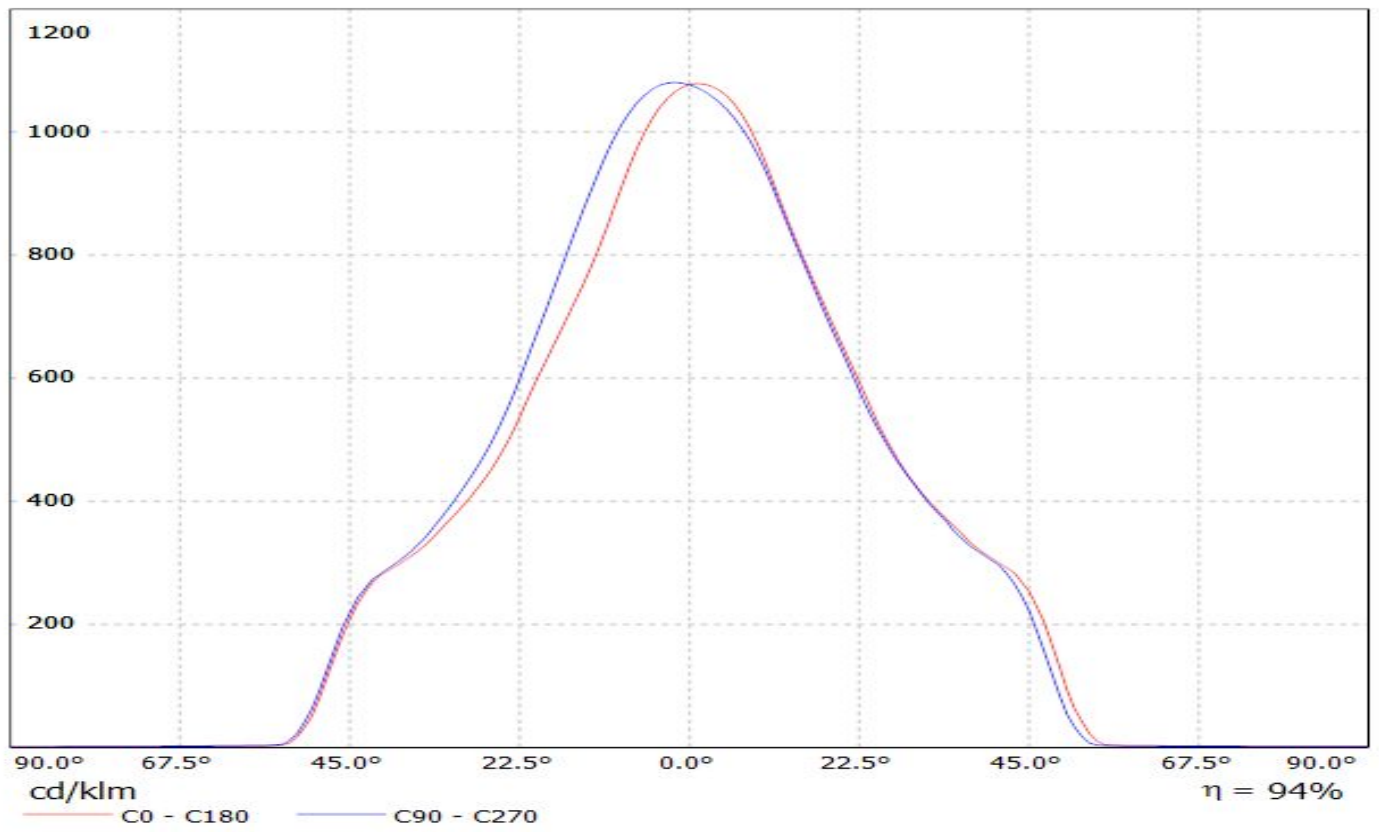

Luminaire: LEDiL Oy F13402_ANGELINA-W_(CXM-14)
Lamps: 1 x LUMINUS_CXM-14_1114.36lm@250mA_P=8.36106W_I=249.8mA

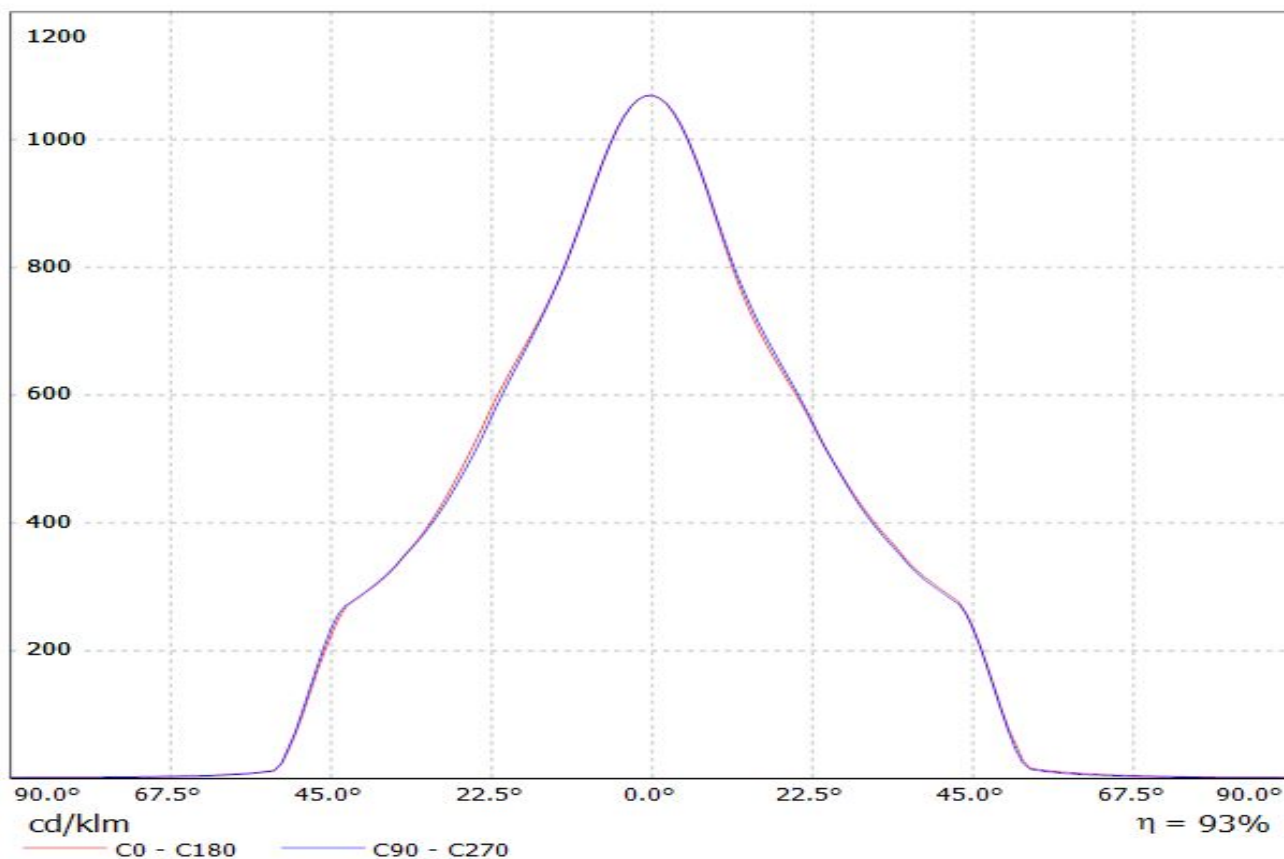

Luminaire: LEDiL F13402_ANGELINA-W

Lamps: 1 x CLL030 740lm@250mA (CLL030-1205A5-303H1A7) CCT:3000K P:8.6W

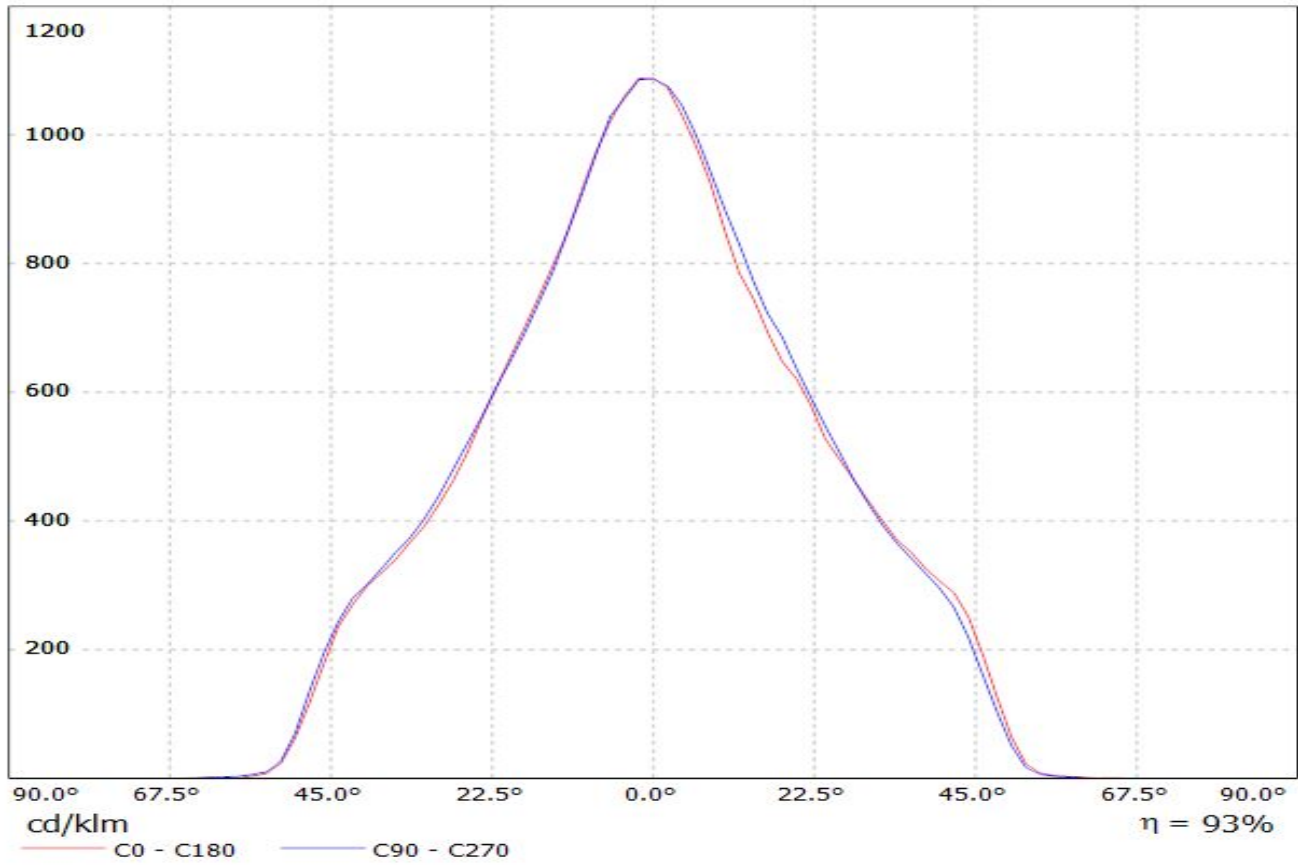

Luminaire: LEDiL Oy F13402_ANGELINA-W_(Luxeon-CoB-1208) Eff: 93 %
Lamps: 1 x Luxeon CoB 1208 (LHC1-3080-1208) 1029lm@250mA CCT=3000K P=8.2W I=250mA

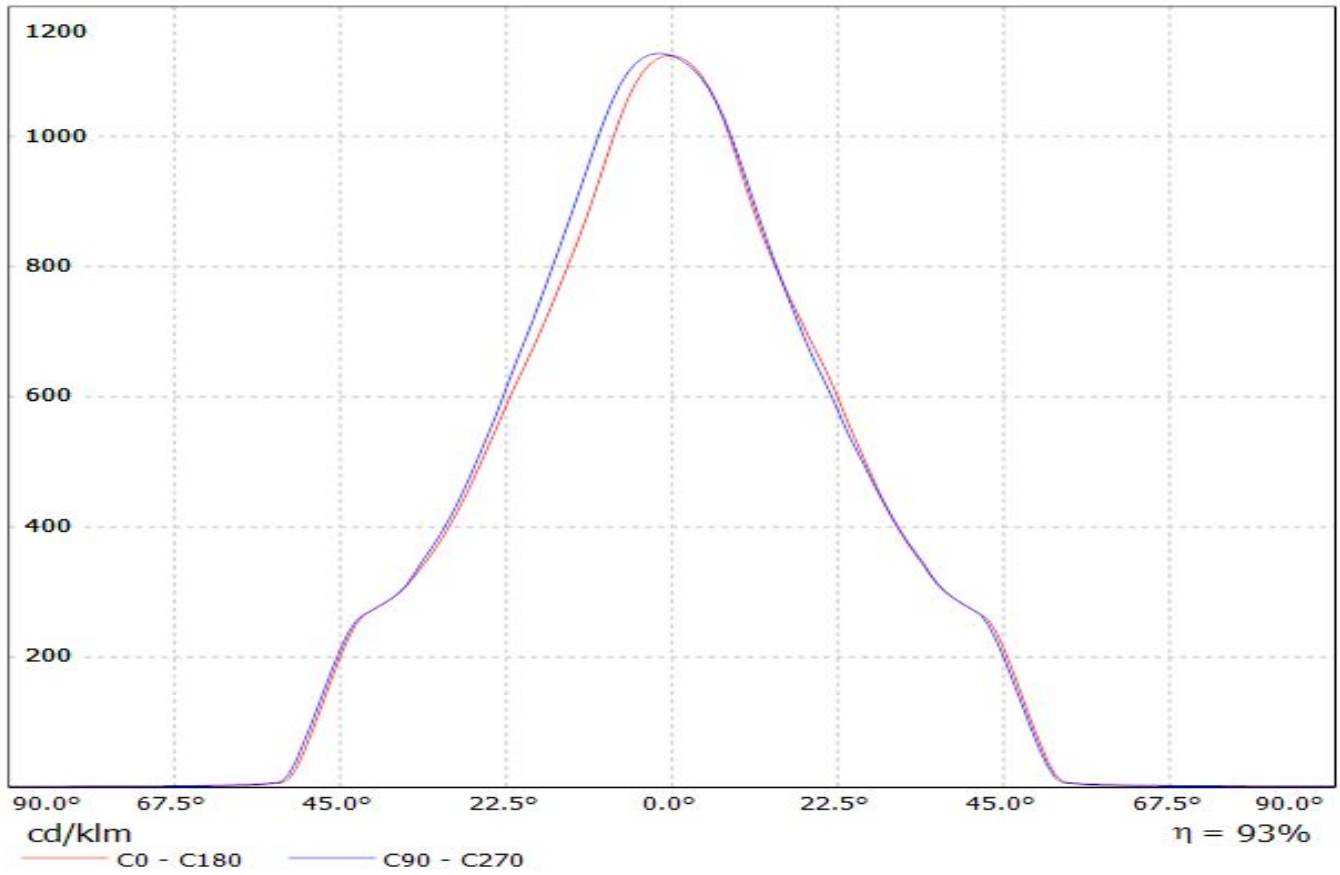

Luminaire: LEDiL Oy F13402_ANGELINA-W_(STARK_SLE_G2_LES19) Eff.91.5%
Lamps: 1 x TRIDONIC STARK SLE G2 LES19 830 CLA 964.643lm@250mA CCT=3000K P=8W I=250mA

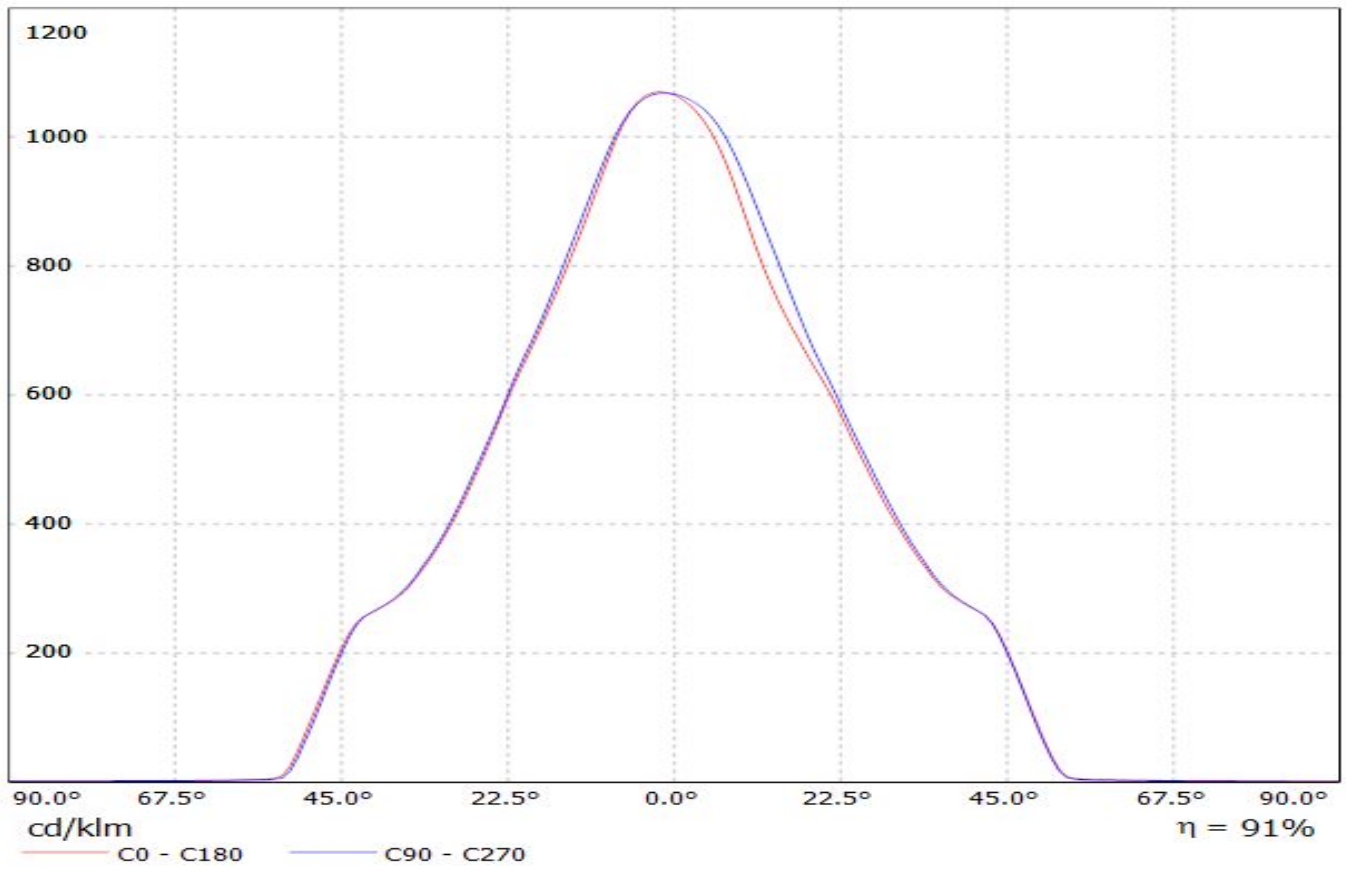

Luminaire: LEDiL Oy F13402_ANGELINA-W_(SOLERIQ_S19_&_TE_2213407-2)
Lamps: 1 x OSRAM_SOLERIQ_S19_(GW_KAHJB1.EM)_1393.62lm@250mA_CCT=3000K_P=10.5683W_I=249.8mA

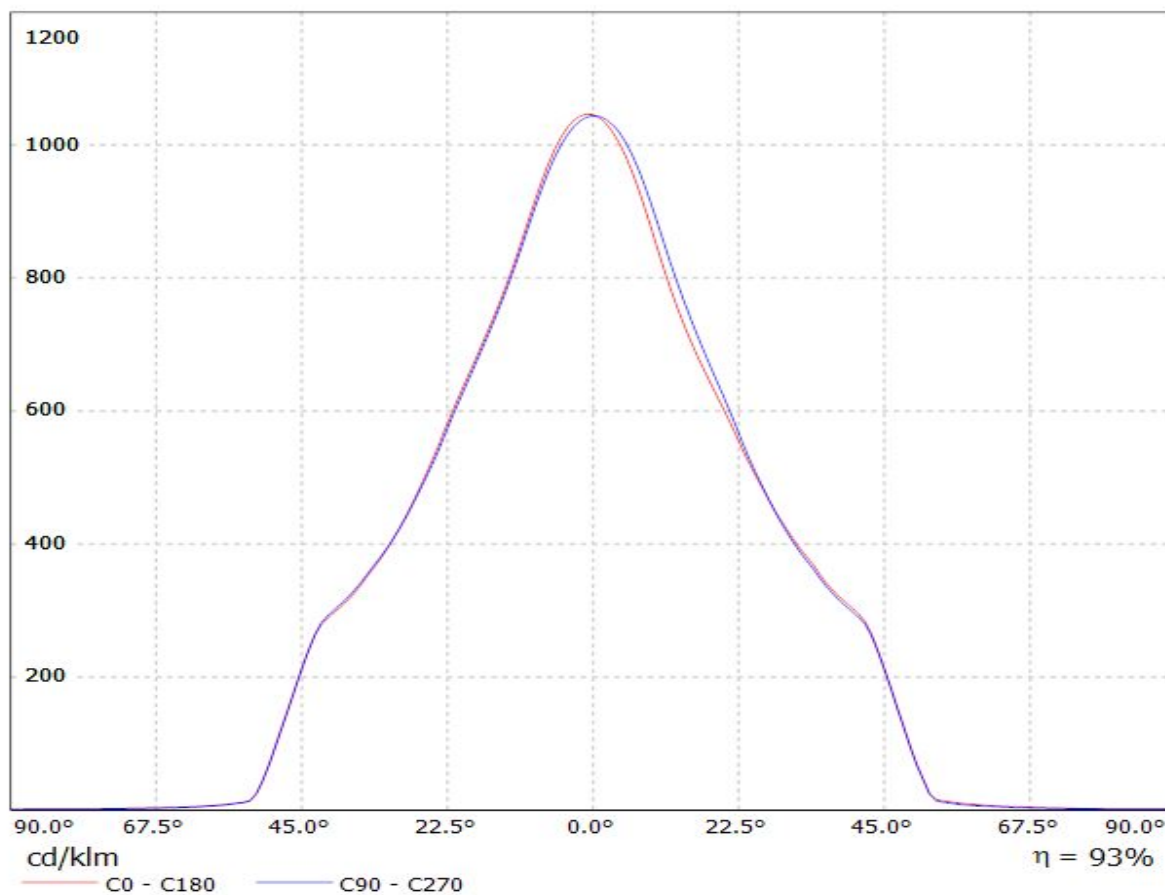

Luminaire: LEDiL Oy F13402_ANGELINA-W (LEP-2000-827-C-AC)
Lamps: 1 x OSRAM PrevaLED Core AC (LEP-2000-827-C-AC)

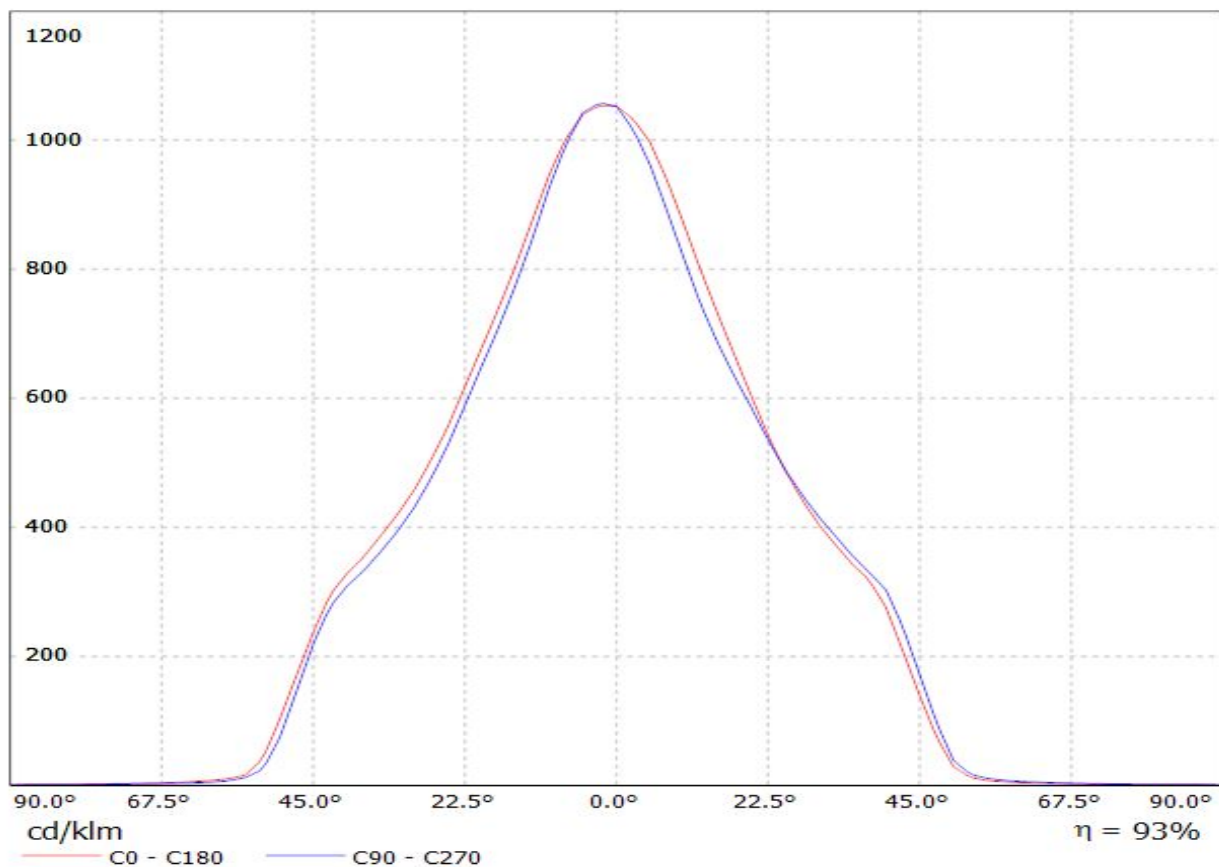

Luminaire: LEDiL Oy F13402_ANGELINA-W_(FORTIMO_2000) Eff.90.5%
Lamps: 1 x PHILIPS Fortimo LED SLM 3000 28W/830 L19 G3 665.774lm@250mA CCT=3000K P=6W I=250mA

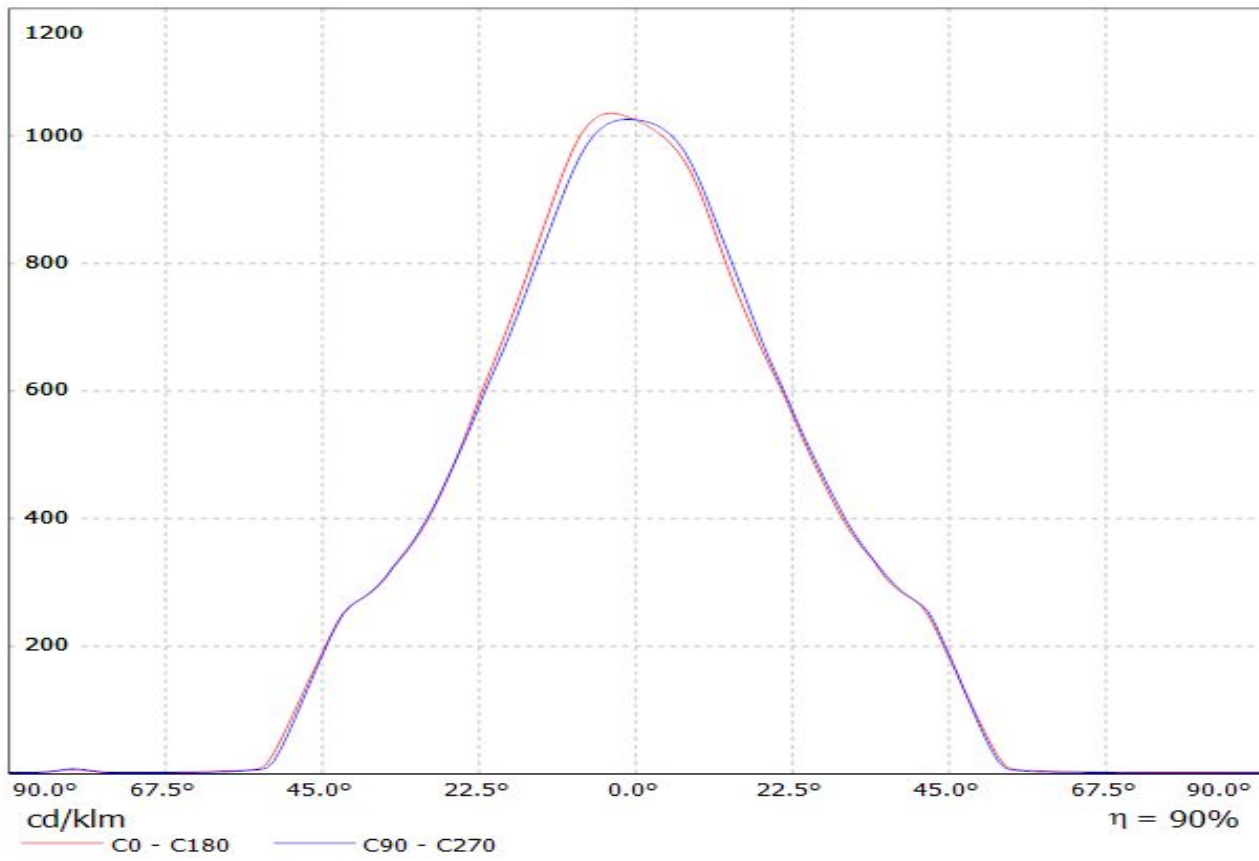

Luminaire: LEDiL Oy F13402_ANGELINA-W_(FORTIMO_3000) Eff.90.2%
Lamps: 1 x PHILIPS Fortimo LED SLM 3000 28W/830 L19 G3 1046.76lm@250mA CCT=3000K P=9W I=250mA

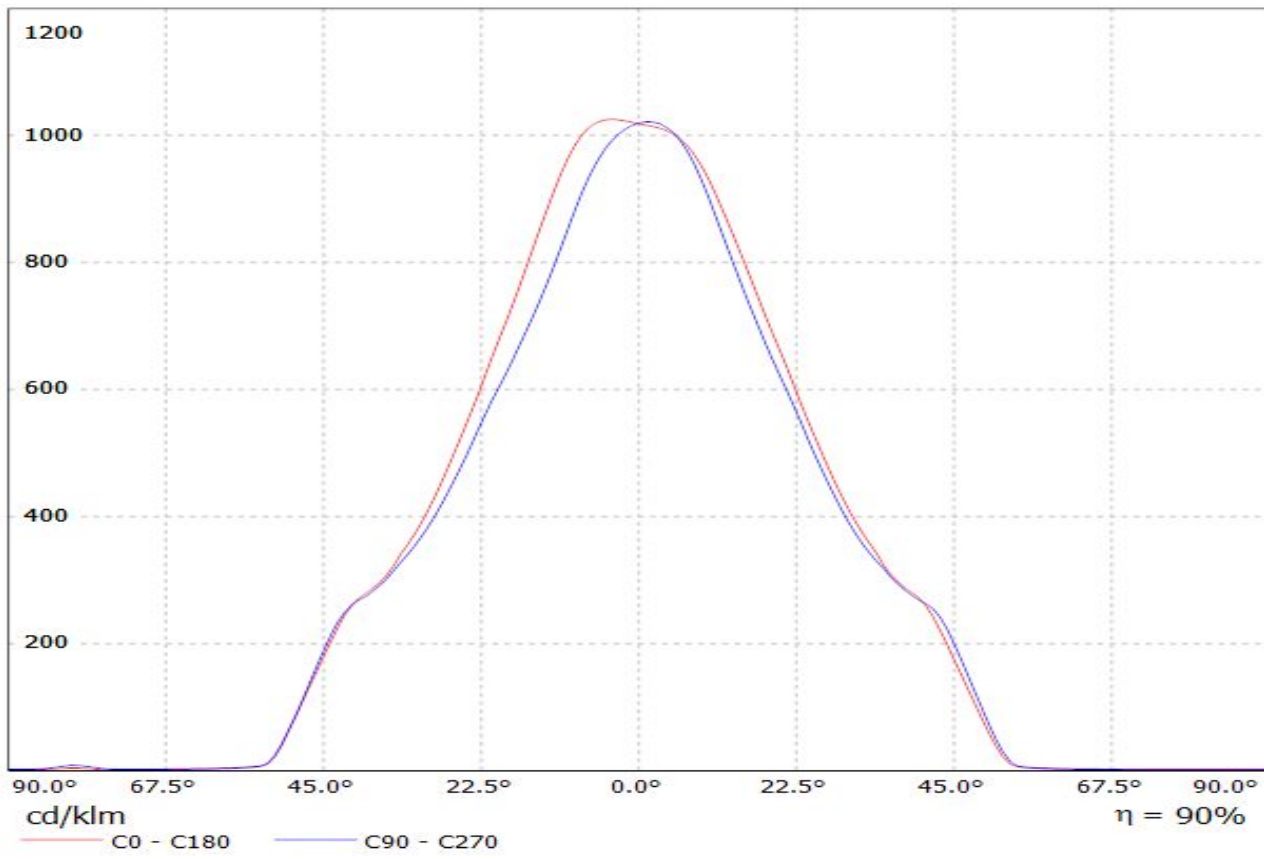

Luminaire: LEDiL Oy F13402_ANGELINA-W_(PrevaLED_LES19)

Lamps: 1 x PrevaLED_LES19_(PL-CORE-2000-830-Z3)_1333.47lm@250mA_P=10.4584W_I=249.8mA

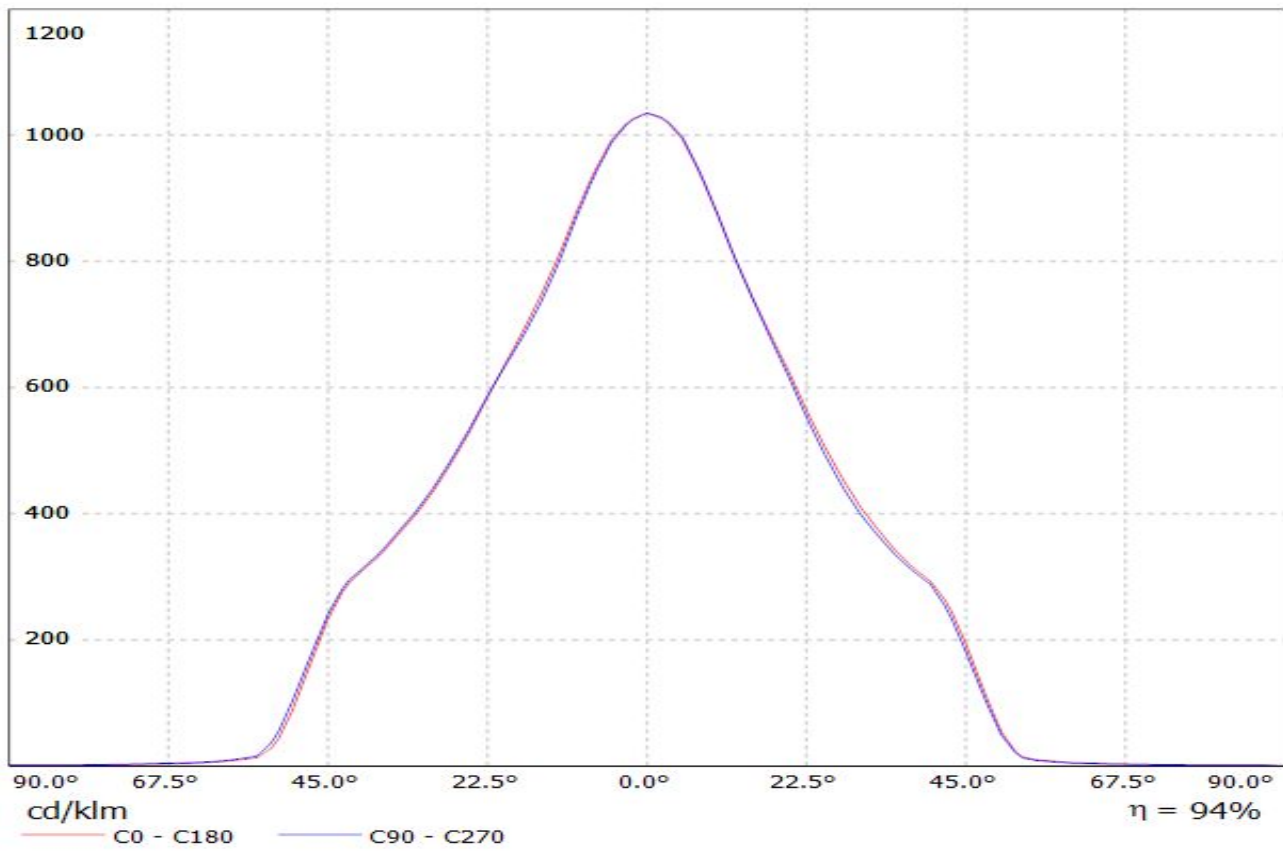

Luminaire: LEDiL Oy F13402_ANGELINA-W_(WU-M-461-827)

Lamps: 1 x Vossloh_WU-M-461-827_773.276lm@250mA_P=6.27423W_I=249.8mA

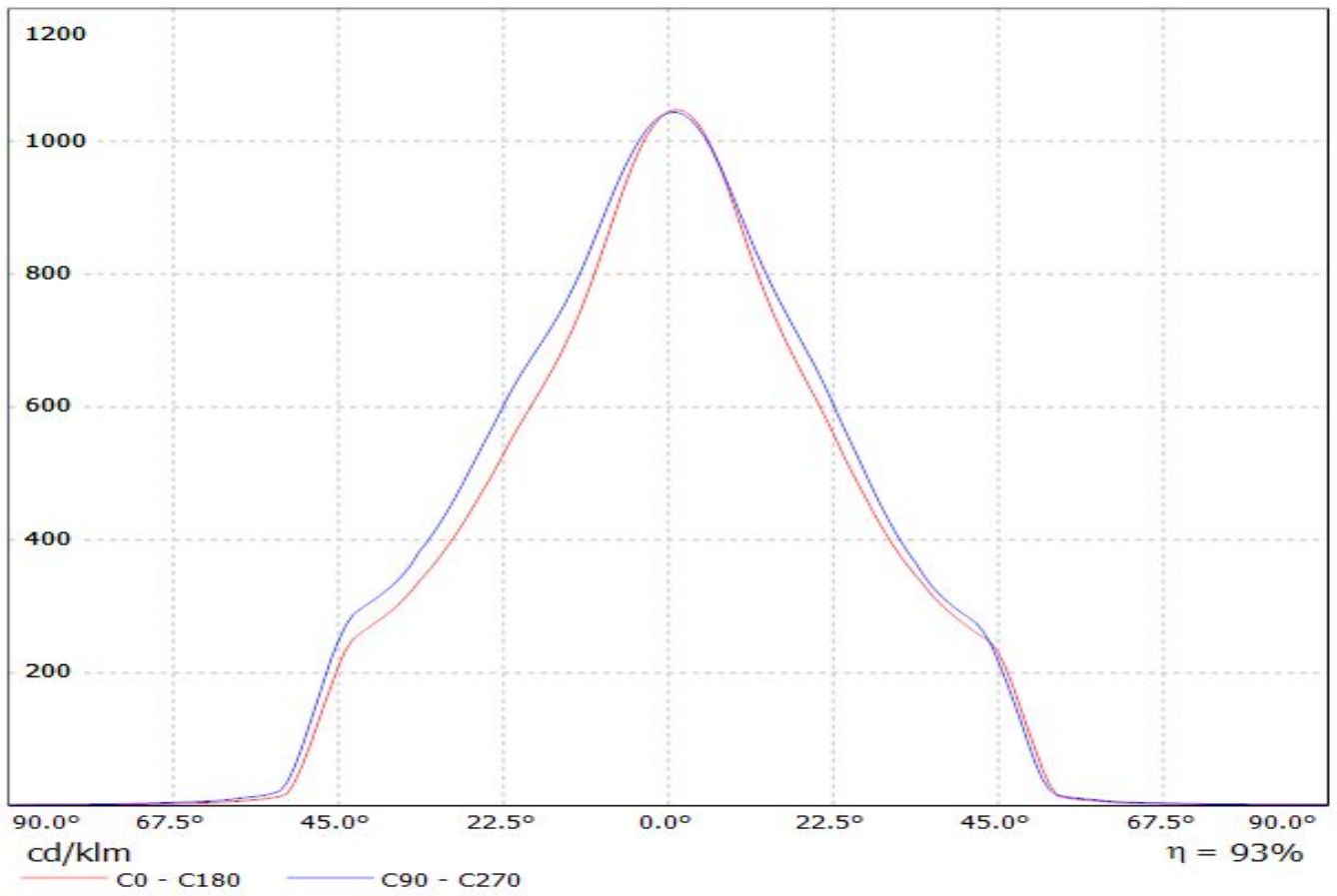

Luminaire: LEDiL Oy F13402_ANGELINA-W_(WU-M-484)

Lamps: 1 x Vossloh_Schwabe-WU-M-484_(WU-M-484-830)_657.125lm@250mA_P=5.59976W_I=249.9mA

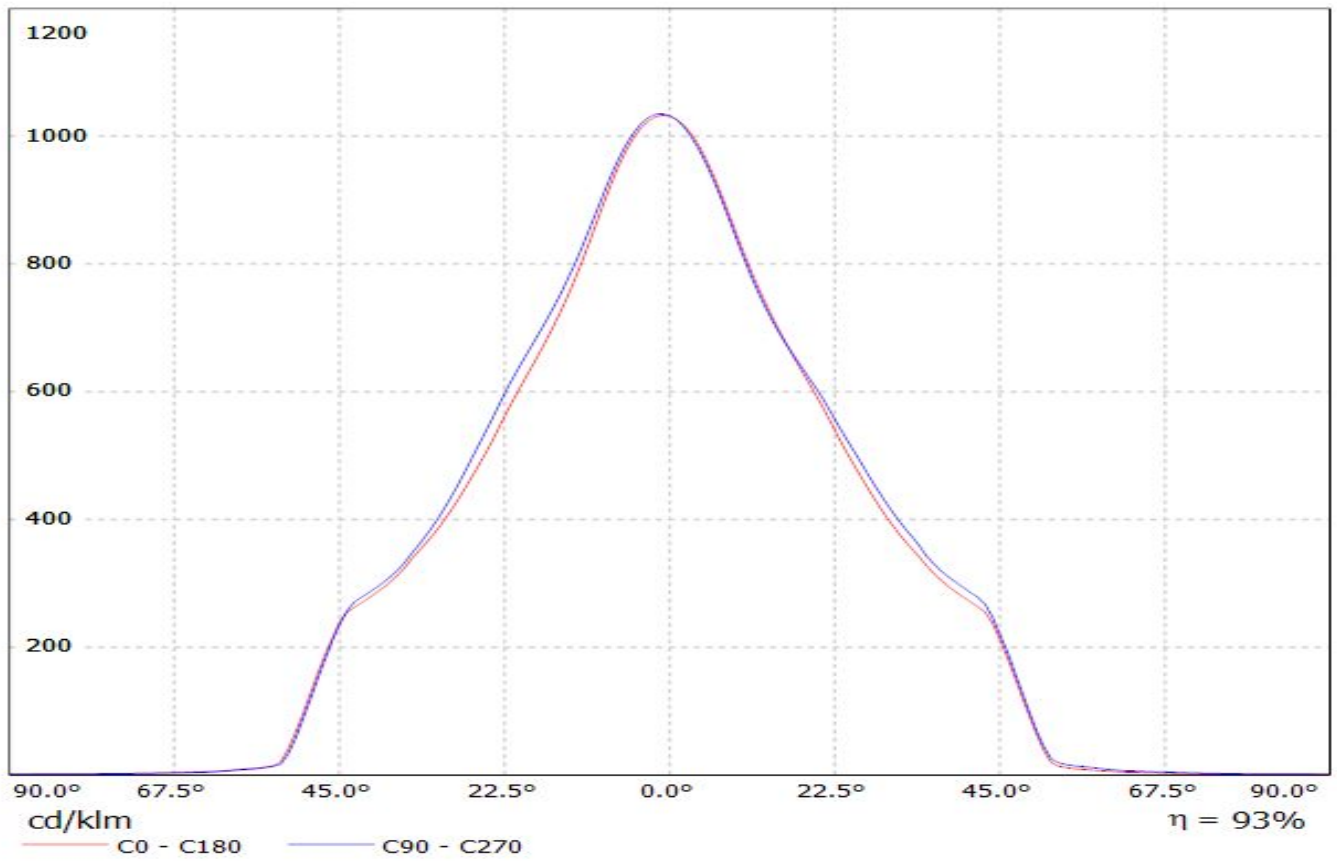

Luminaire: LEDiL Oy F13402_ANGELINA-W_(COB-LC026B) Eff.92.4%
Lamps: 1 x SAMSUNG_COB-LC026B_(SPHWWTHDNC25YHV52F)_1136.23lm@250mA_P=8.23191W_I=249.8mA

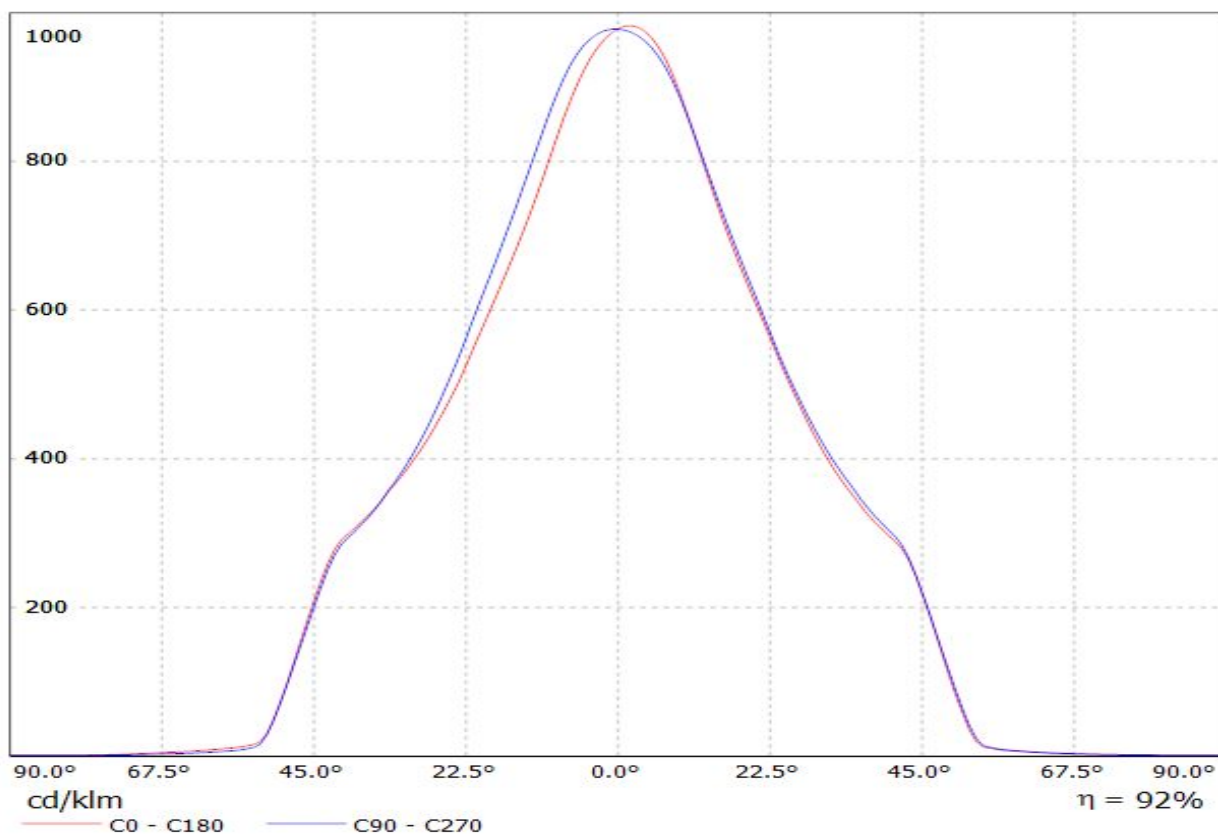

Luminaire: LEDiL Oy F13402_ANGELINA-W_(SLE_G3_LES19) Eff.92.2%

Lamps: 1 x TRIDONIC_STARK_SLE_G3_LES19_(STARK-SLE-G3-LES19-2000-840-CLA)_1058.33lm@250mA_P=8.32833W_I=249.8mA

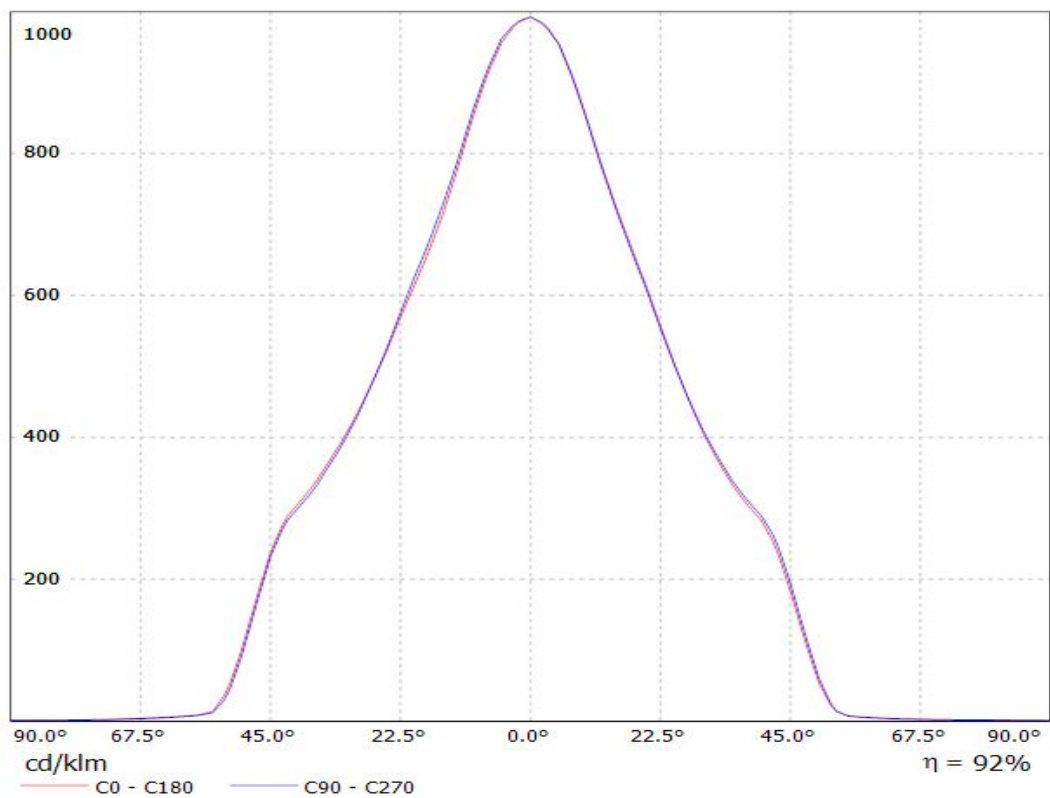

Luminaire: LEDiL Oy F13402_ANGELINA-W_(NSBxL121A)
Lamps: 1 x Nichia_NSBxL121A_914.478lm@250mA_P=7.56872W_I=249.9mA

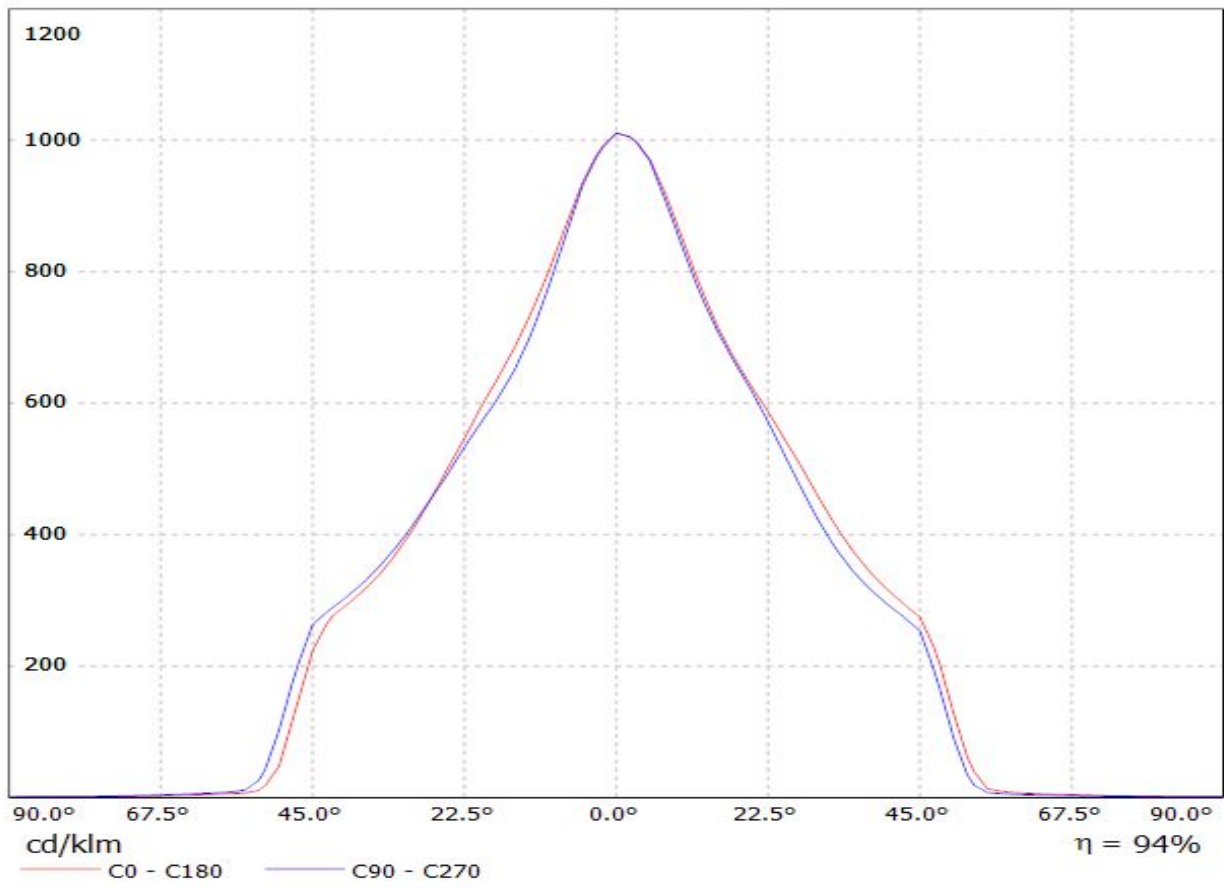

Luminaire: LEDiL Oy F13402_ANGELINA-W_(CXA30) Eff. 93%
Lamps: 1 x CREE_CXA30_(CXA3050-3C0-Y2-N0H)_1340.66lm@250mA_P=8.16471W_CCT=5000K_I=249.8mA

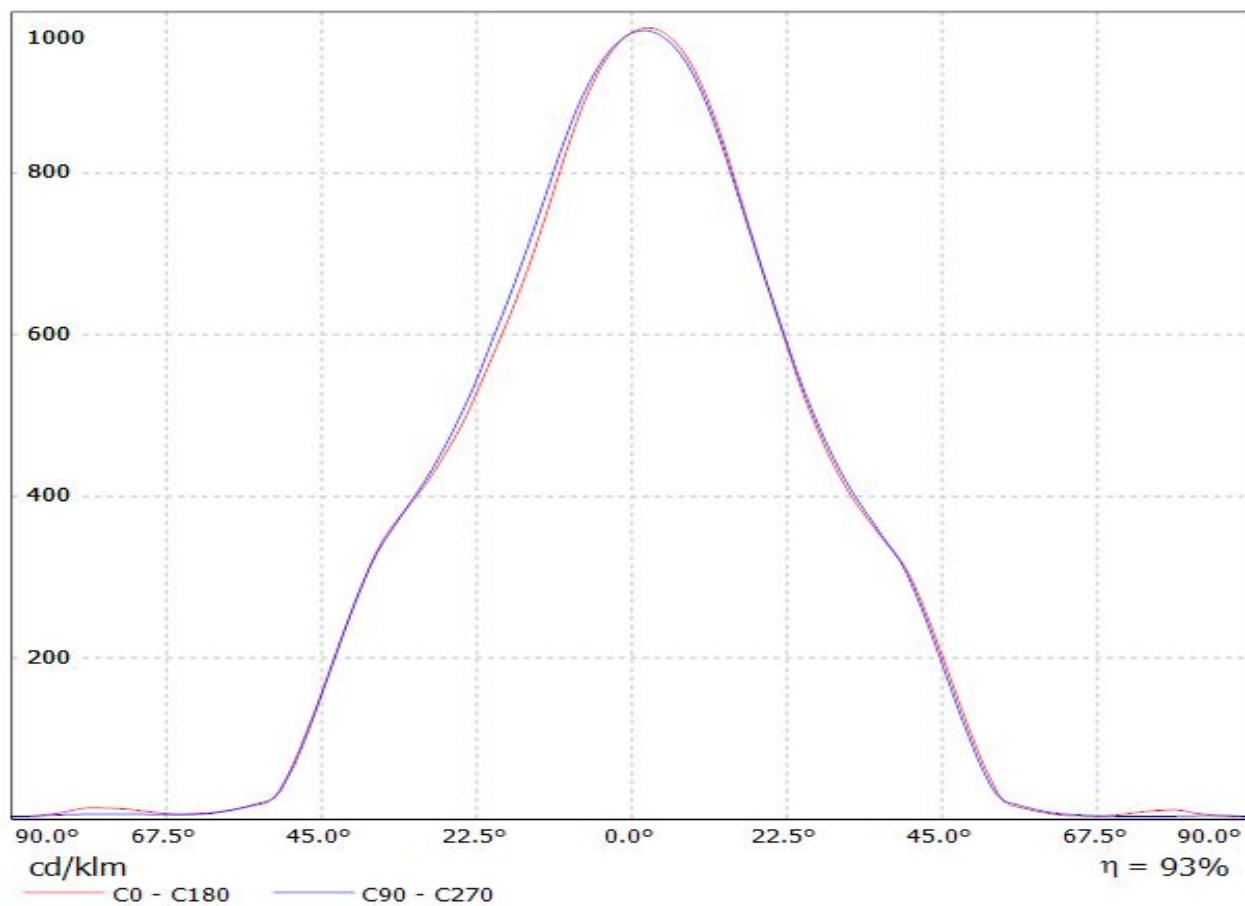

Luminaire: LEDiL Oy F13402_ANGELINA-W_(STARK_SLE_G2_LES23) Eff 90.2%
Lamps: 1 x TRIDONIC STARK SLE G2 LES23 830 CLA 982.73lm@250mA CCT=3000K P=8W I=250mA

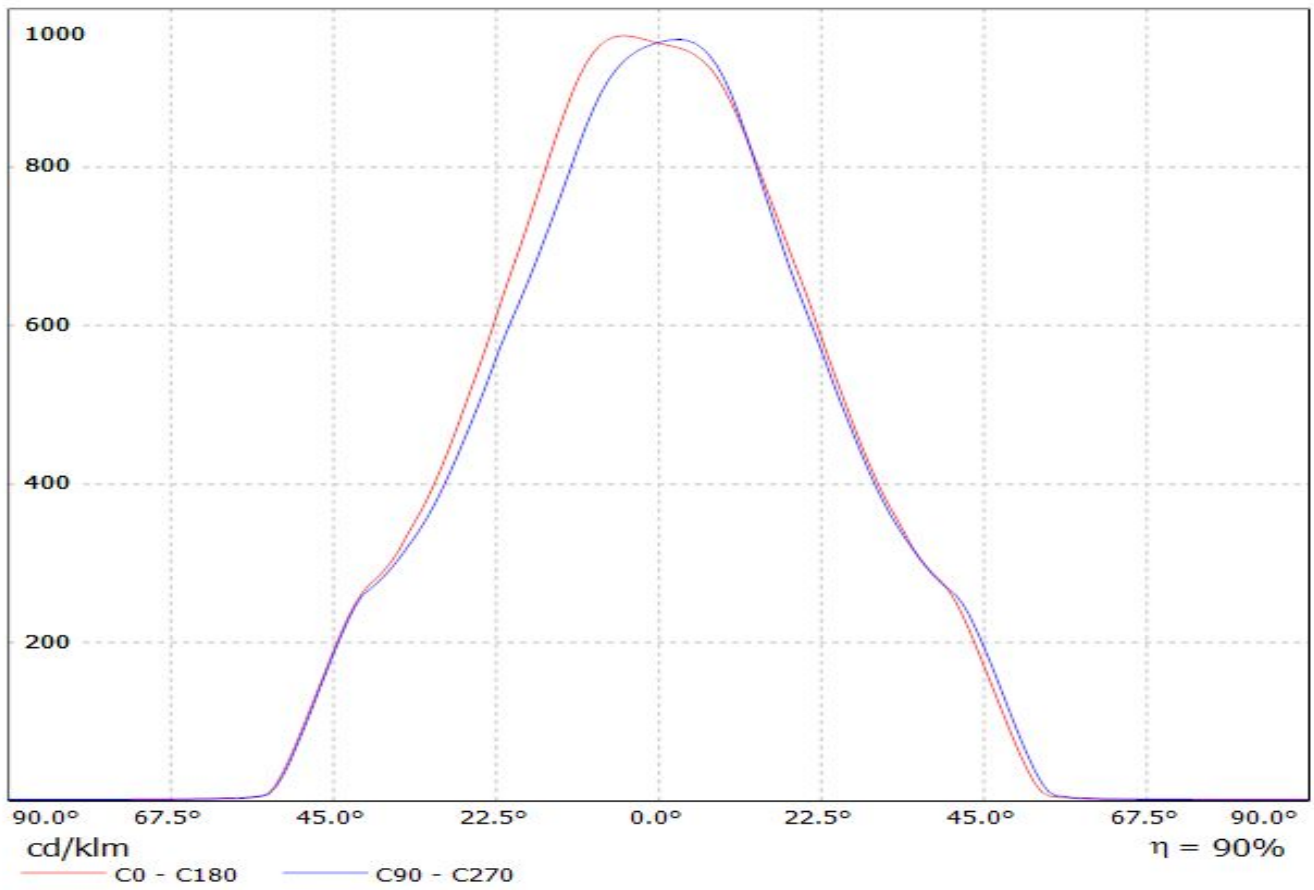

Luminaire: LEDiL Oy F13402_ANGELINA-W_(FORTIMO_4500) Eff.89.0%
Lamps: 1 x PHILIPS Fortimo 4500

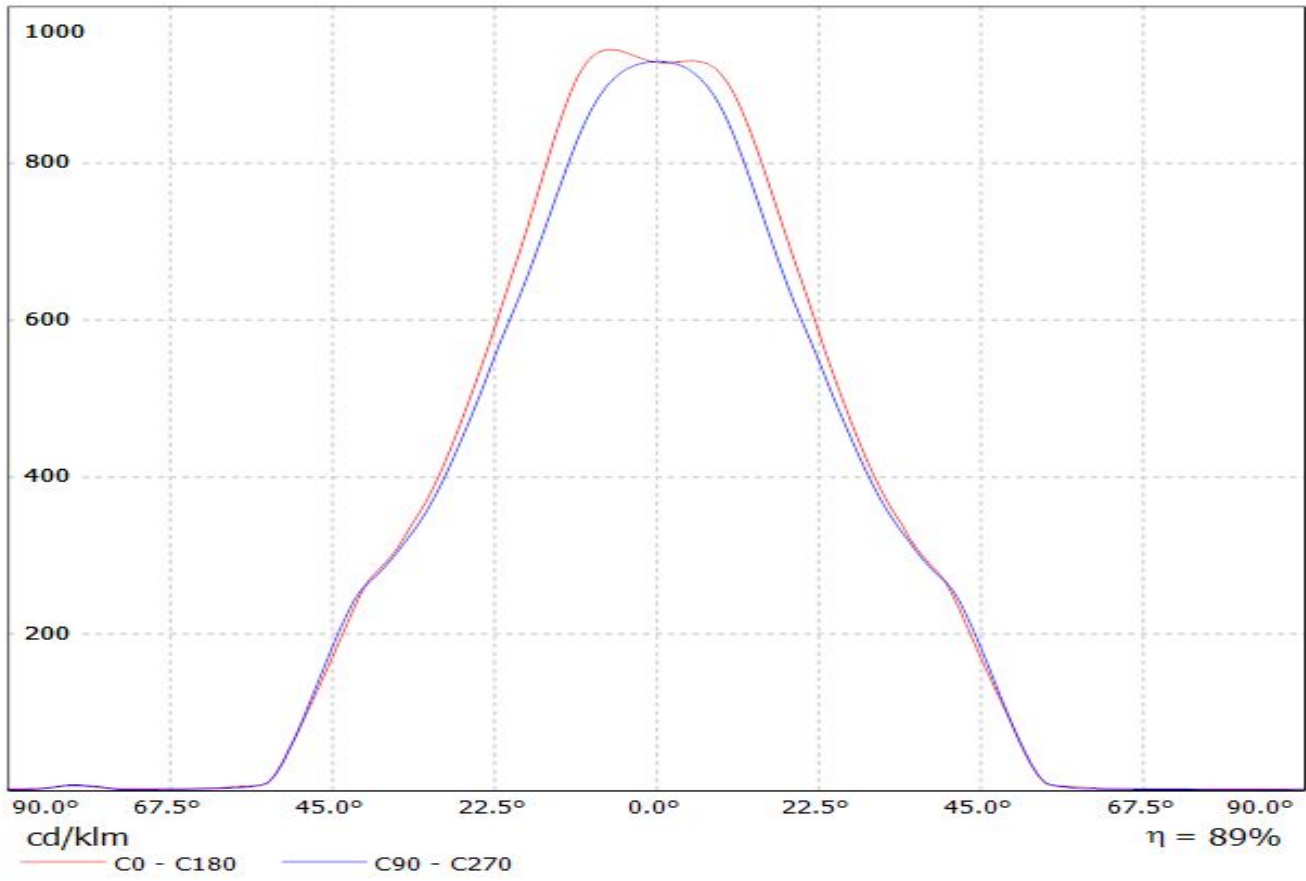

Luminaire: LEDiL Oy F13402_ANGELINA-W_(STARK_SLE_G2_LES26) Eff.89.0%
Lamps: 1 x TRIDONIC STARK SLE G2 LES26 830 CLA 1095.88lm@250mA CCT=3000K P=8W I=250mA

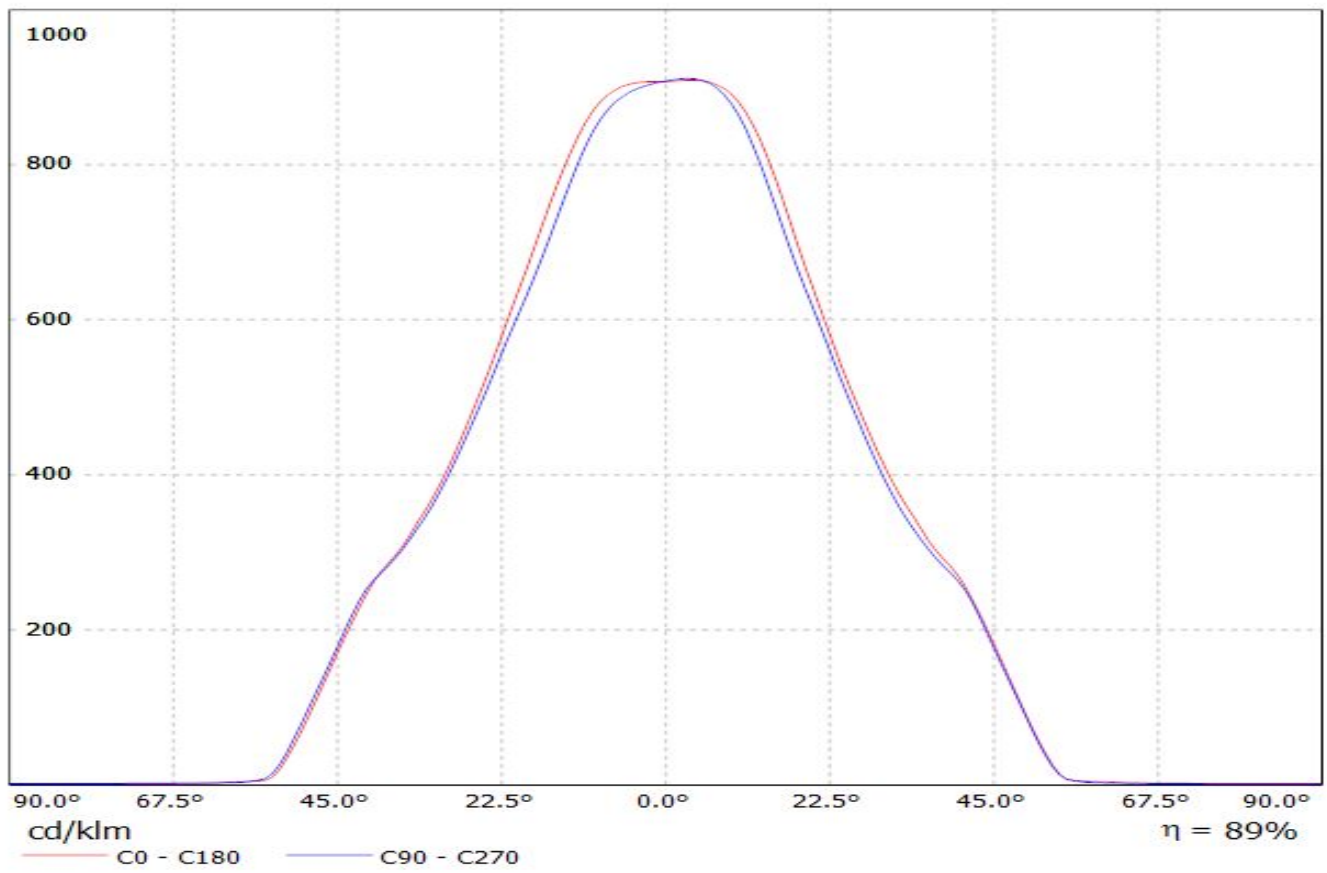

Luminaire: LEDiL Oy F13402_ANGELINA-W_(PrevaLED_LES23) Eff. 94%
Lamps: 1 x OSRAM PrevaLED_LES23_(PL-CORE-5000-930-Z3)_1102.2lm@250mA_P=9.93654W_I=249.8mA

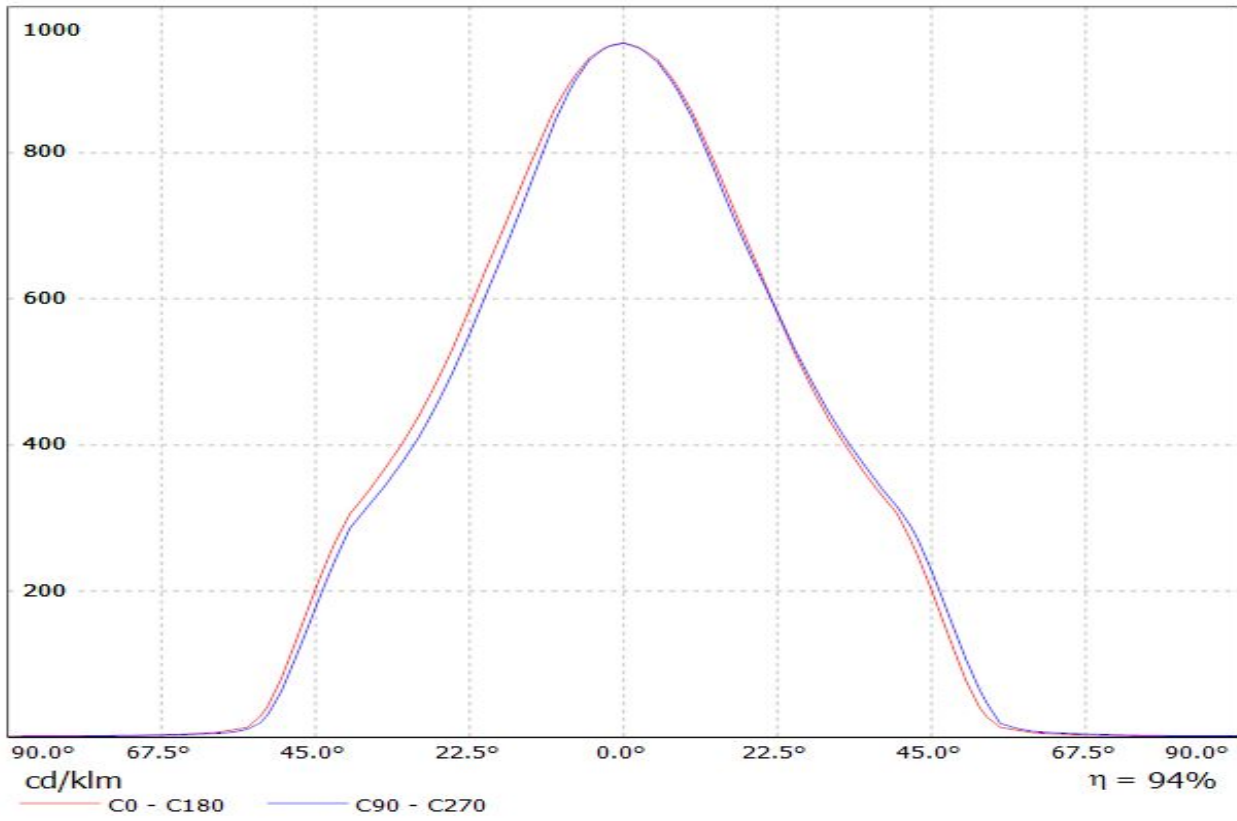

Luminaire: LEDiL Oy F13402_ANGELINA-W_(WU-M-462-827)

Lamps: 1 x Vossloh_WU-M-462-827_1116.7lm@250mA_P=8.9943W_I=249.8mA

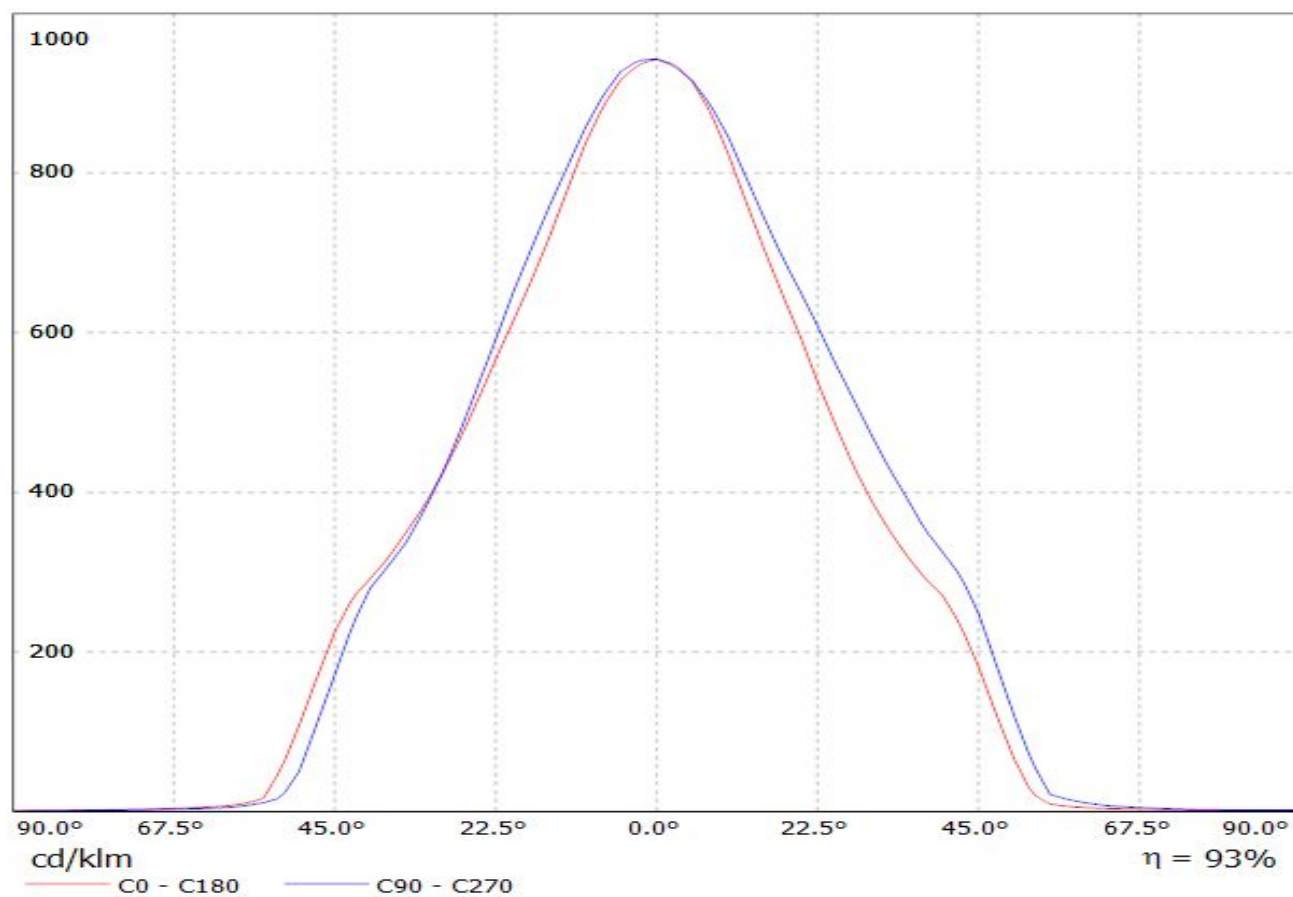

Luminaire: LEDiL Oy F13402_ANGELINA-W_(WU-M-464-827)
Lamps: 1 x Vossloh_WU-M-464-827_1452.93lm@250mA_P=11.6939W_I=249.8mA

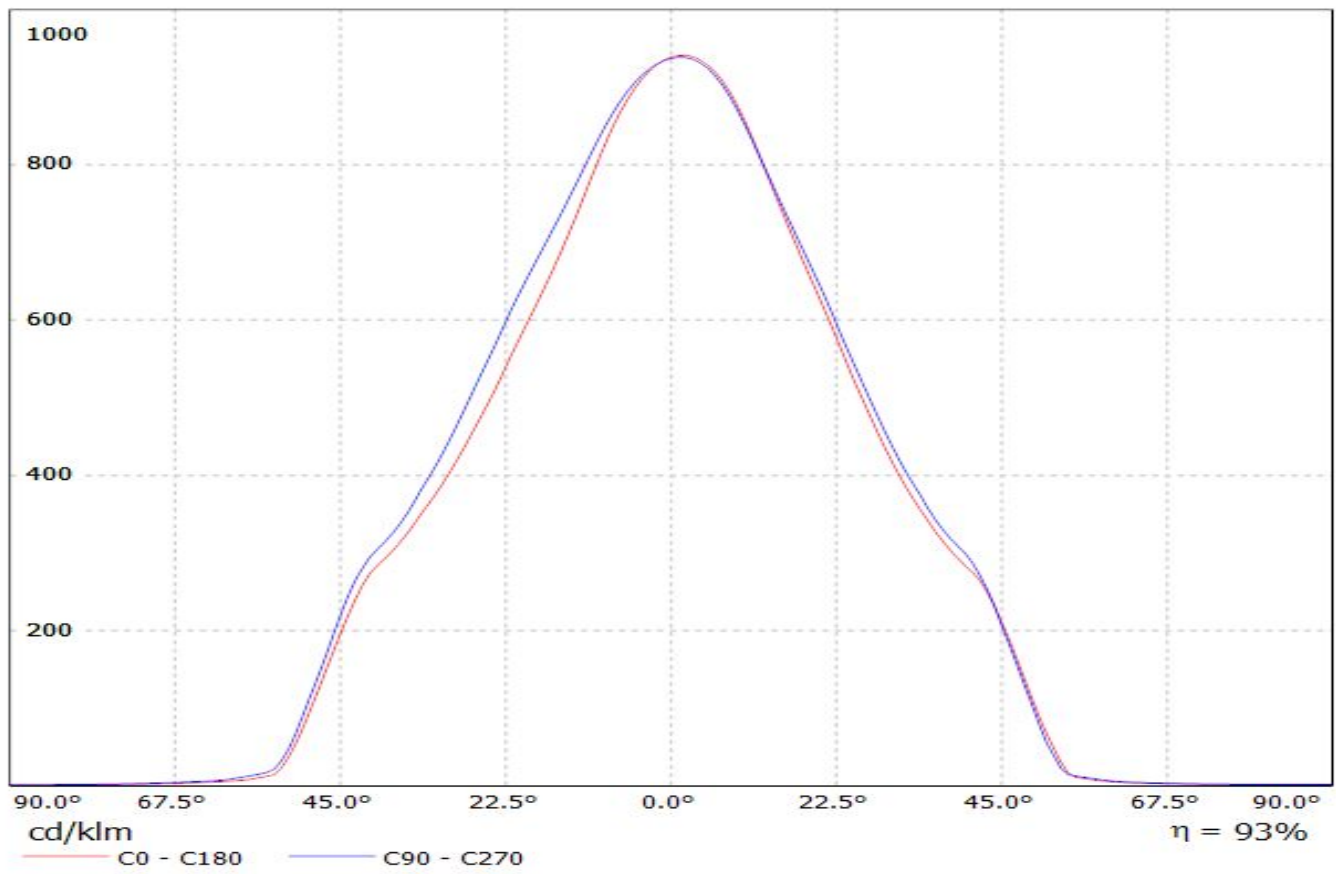

Luminaire: LEDiL Oy F13402_ANGELINA-W_(WU-M-486) Eff.92.5%
Lamps: 1 x Vossloh_Schwabe-WU-M-486_(WU-M-486-830)
_1474.55lm@250mA_P=10.4456W_I=249.8mA

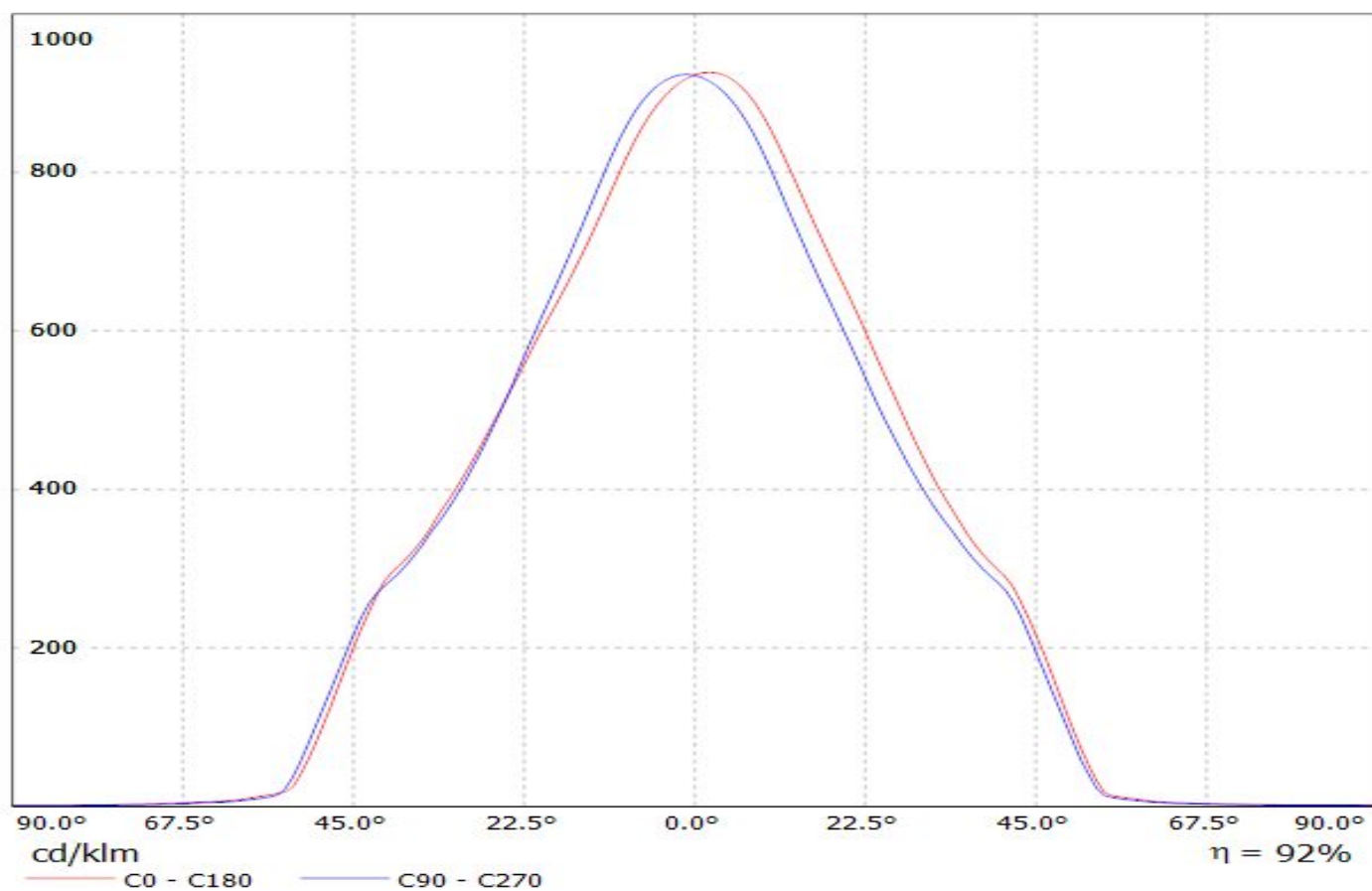

Luminaire: LEDiL Oy F13402_ANGELINA-W_(SLE_G3_LES23) Eff 90.3%

Lamps: 1 x TRIDONIC_STARK_SLE_G3_LES23_(STARK-SLE-PURE_G3-23-3000-930-SEL)_813.196lm@250mA_CCT=3000K_P=8.20018W_I=249.8mA

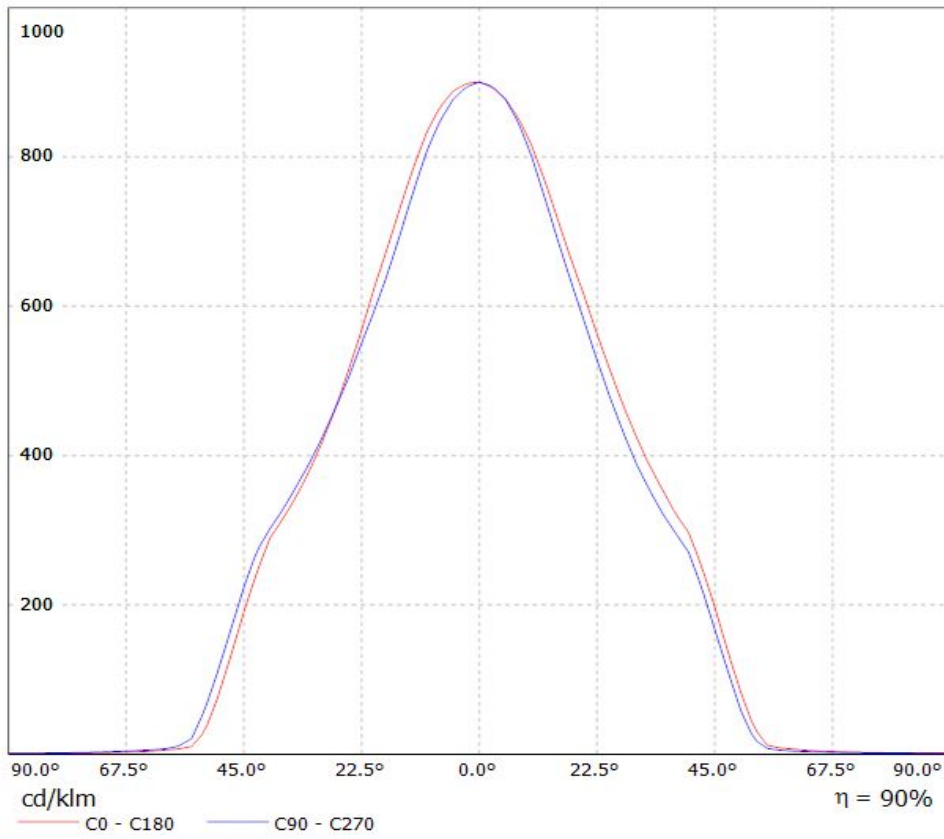

Luminaire: LEDiL Oy F13402_ANGELINA-W_(WU-M-484)

Lamps: 1 x Vossloh_Schwabe-WU-M-485_(WU-M-485-830)_1209.62lm@250mA_P=8.43849W_I=249.8mA

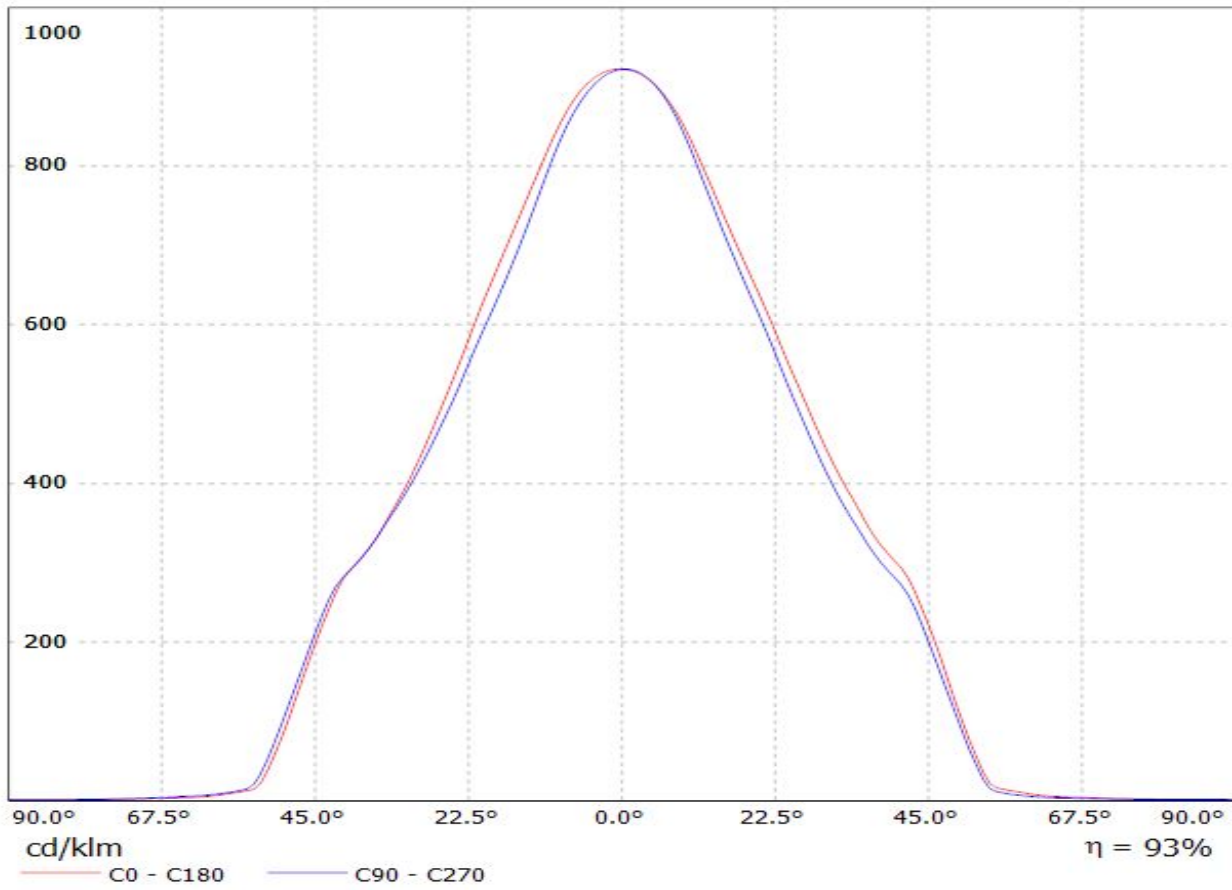

Luminaire: LEDiL Oy F13402_ANGELINA-W_(PrevaLED_LES9) Eff. 93%

Lamps: 1 x PrevaLED_LES9_(PL-CORE-1100-830-Z3)_507.9lm@100mA_P=4.5039W_I=100.1mA

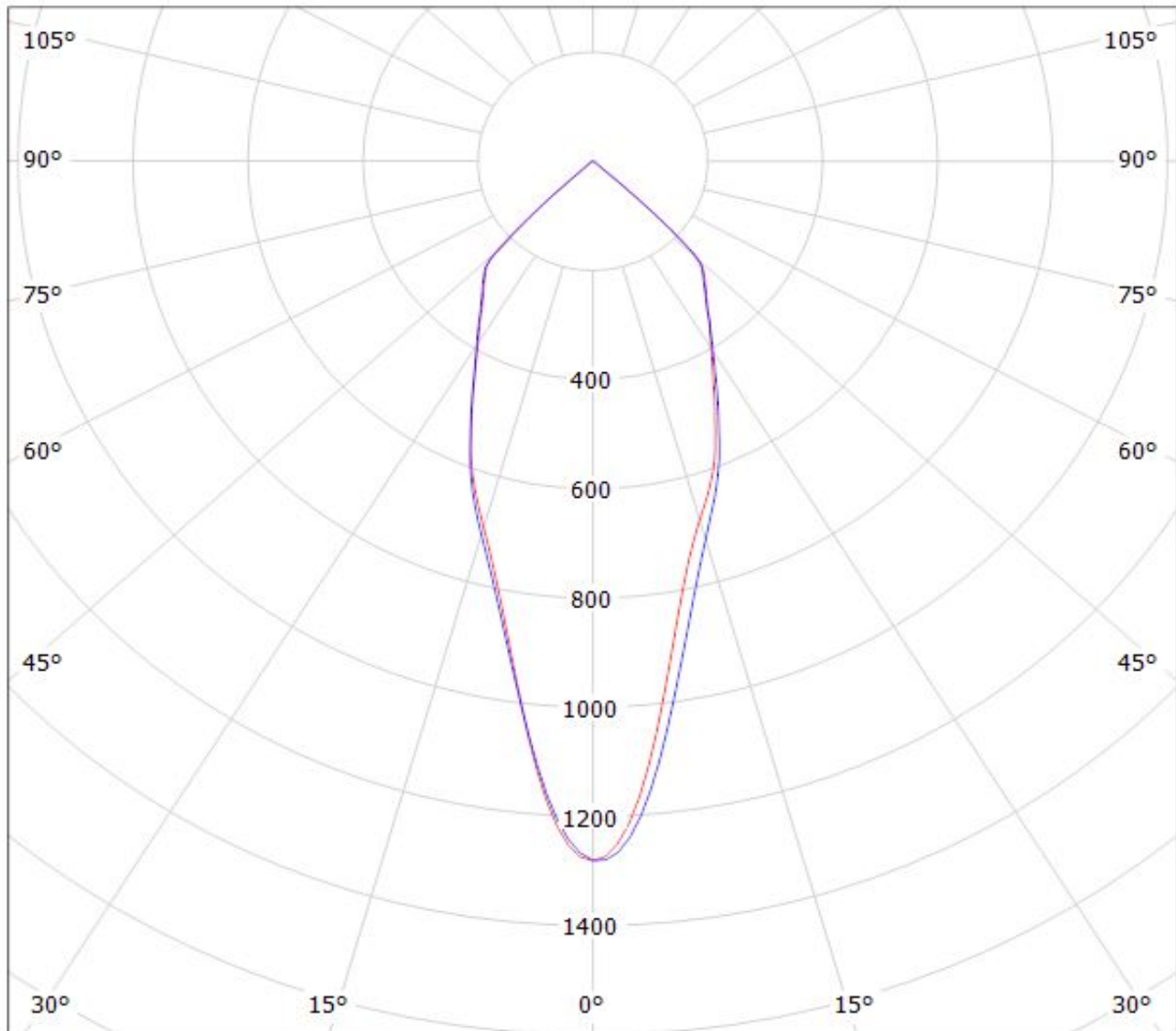

cd/klm

$\eta = 94\%$

— C0 - C180

— C90 - C270

Luminaire: LEDiL Oy F13402_ANGELINA-W_(CXA1816) Eff. 94%
Lamps: 1 x CREE_CXA1816_1042.78lm@250mA_P=8.65157W_I=249.9mA

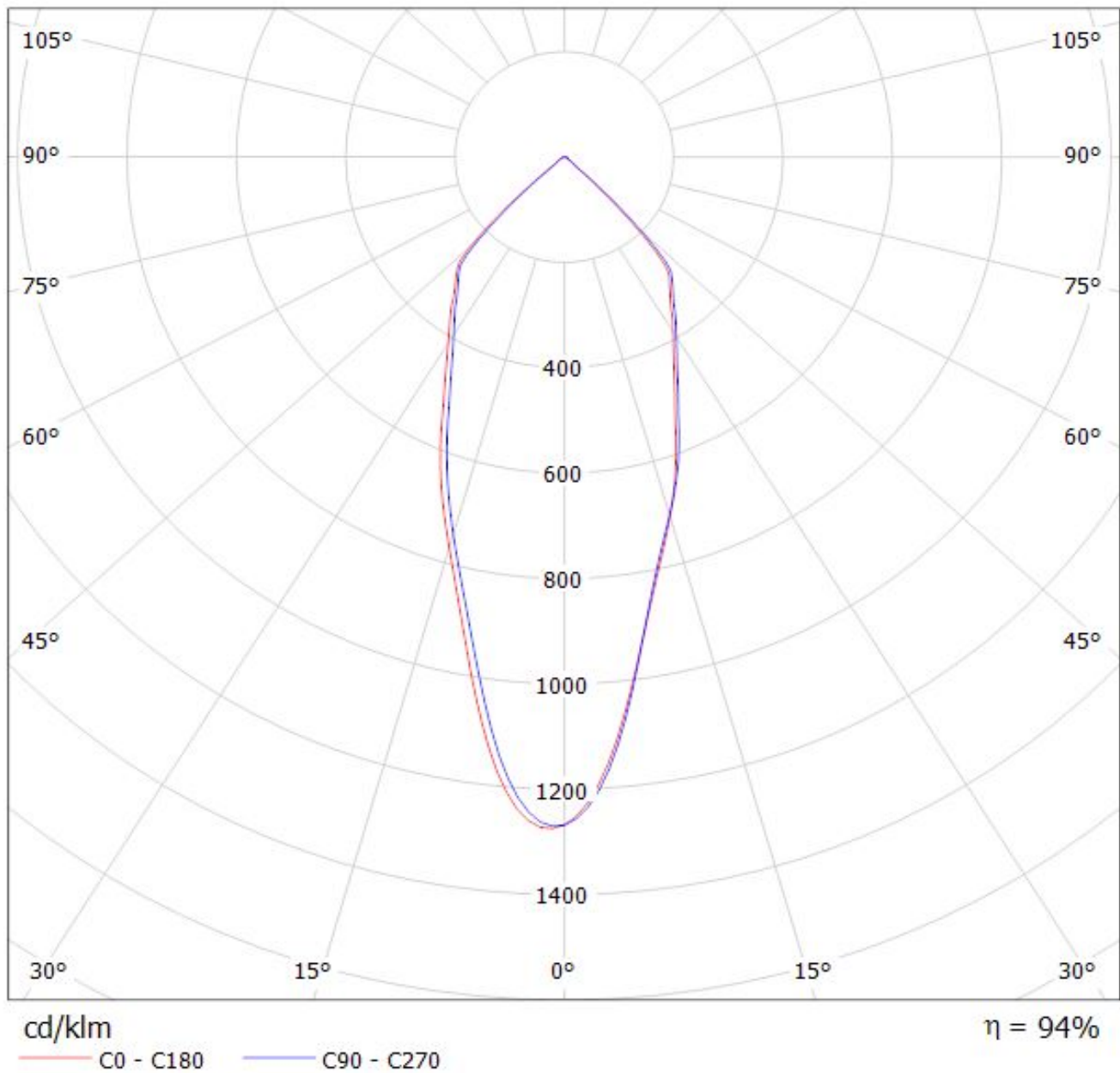

Luminaire: LEDiL Oy F13402_ANGELINA-W_(NSBxL121A) Eff.90.9%

Lamps: 1 x NICHIA_NSBxL121A_(NSBLL121AE)_805.561lm@250mA_CCT=3000K_P=7.3681W_I=249.8mA

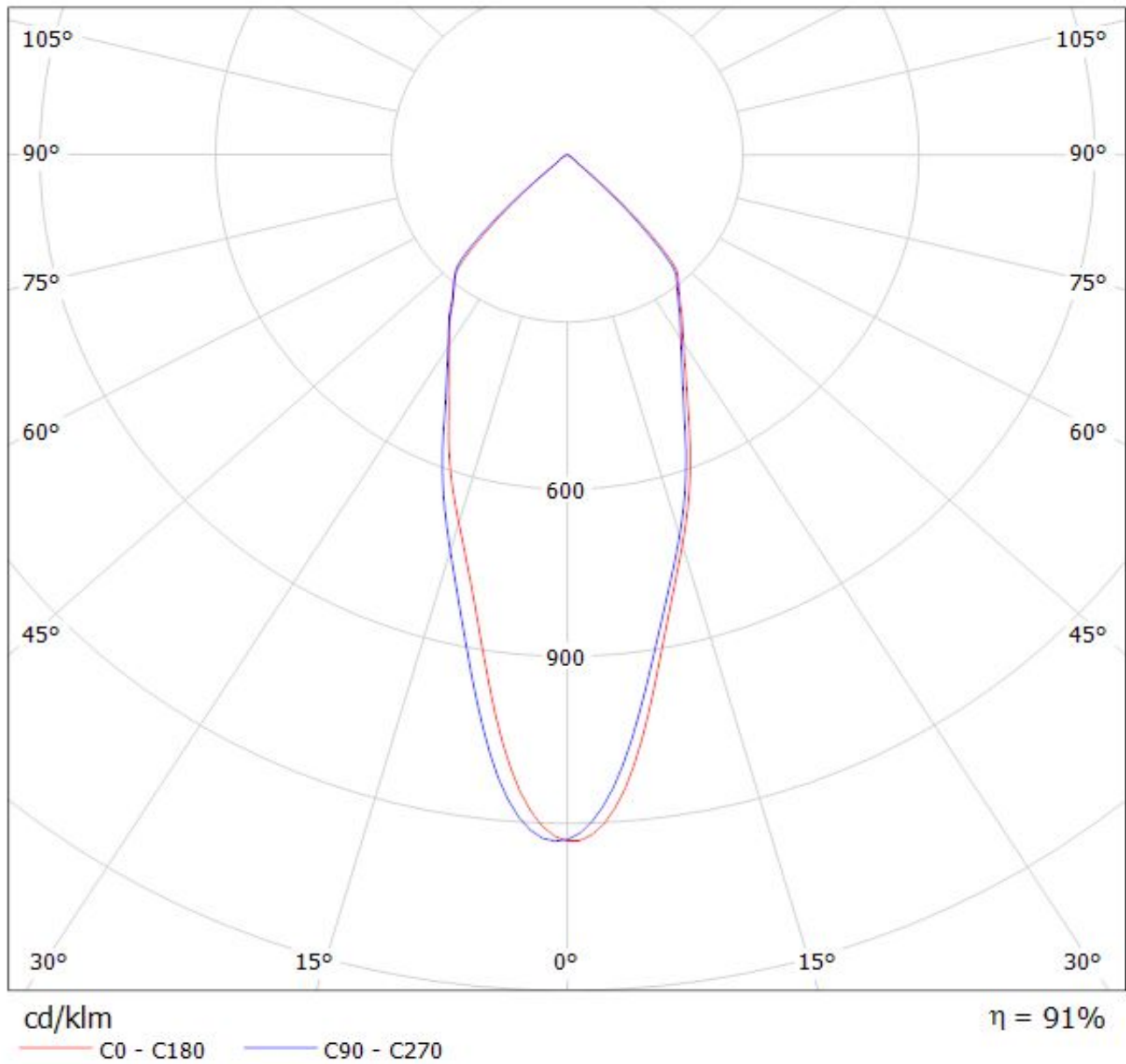

Luminaire: LEDiL Oy F13402_ANGELINA-W_(LEP-800-827-C-AC)

Lamps: 1 x OSRAM PrevaLED Core AC (LEP-800-827-C-AC) 910lm@60mA U:230V P:14W

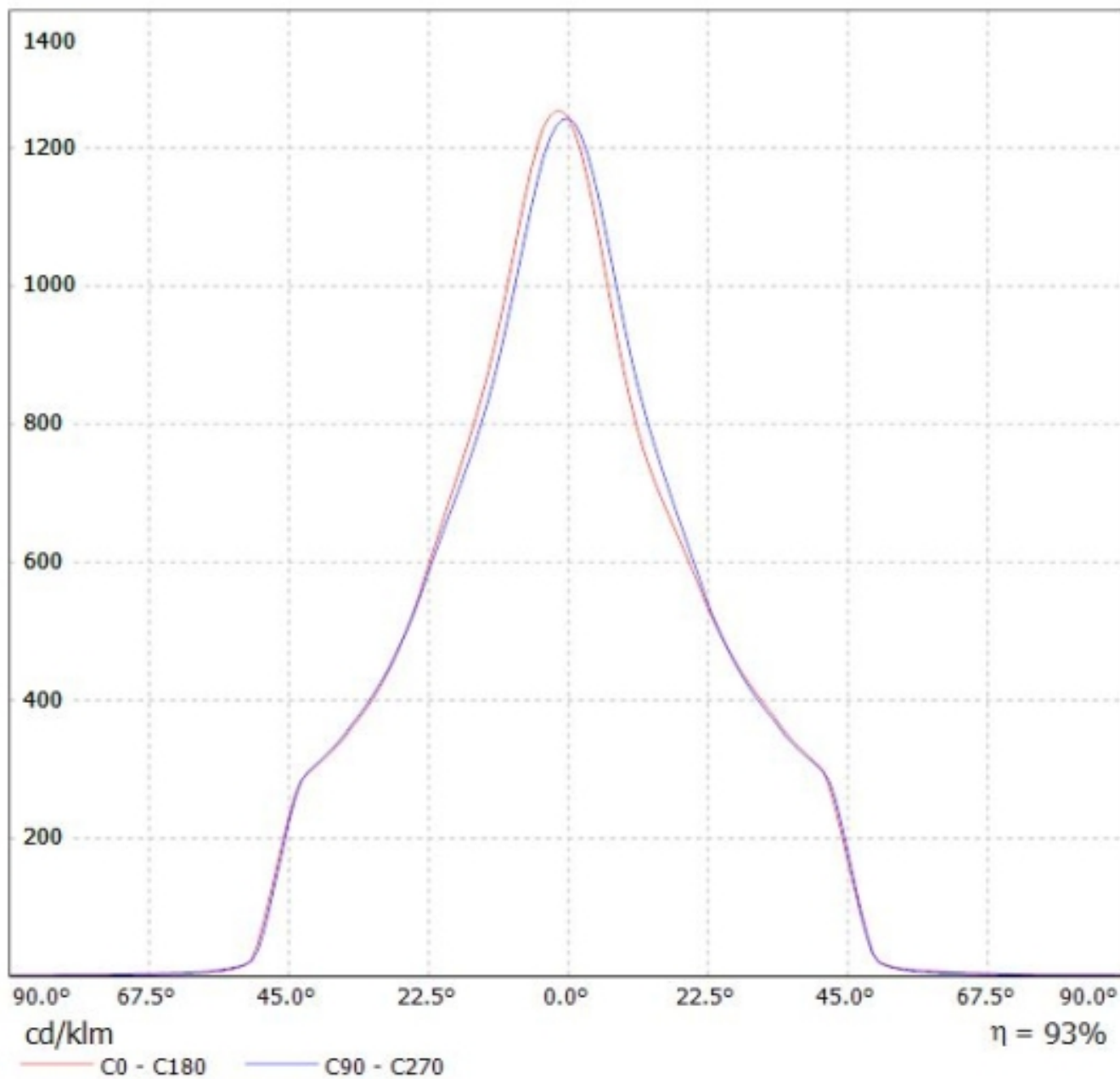

Luminaire: LEDiL Oy F13402_ANGELINA-W_(LUXEON_COB_1205) Eff.93.0%
Lamps: 1 x LUXEON_COB_1205_(LHC1-3080-1205)_1084.49lm@250mA_CCT=3000K_P=8.31784W_I=249.8mA

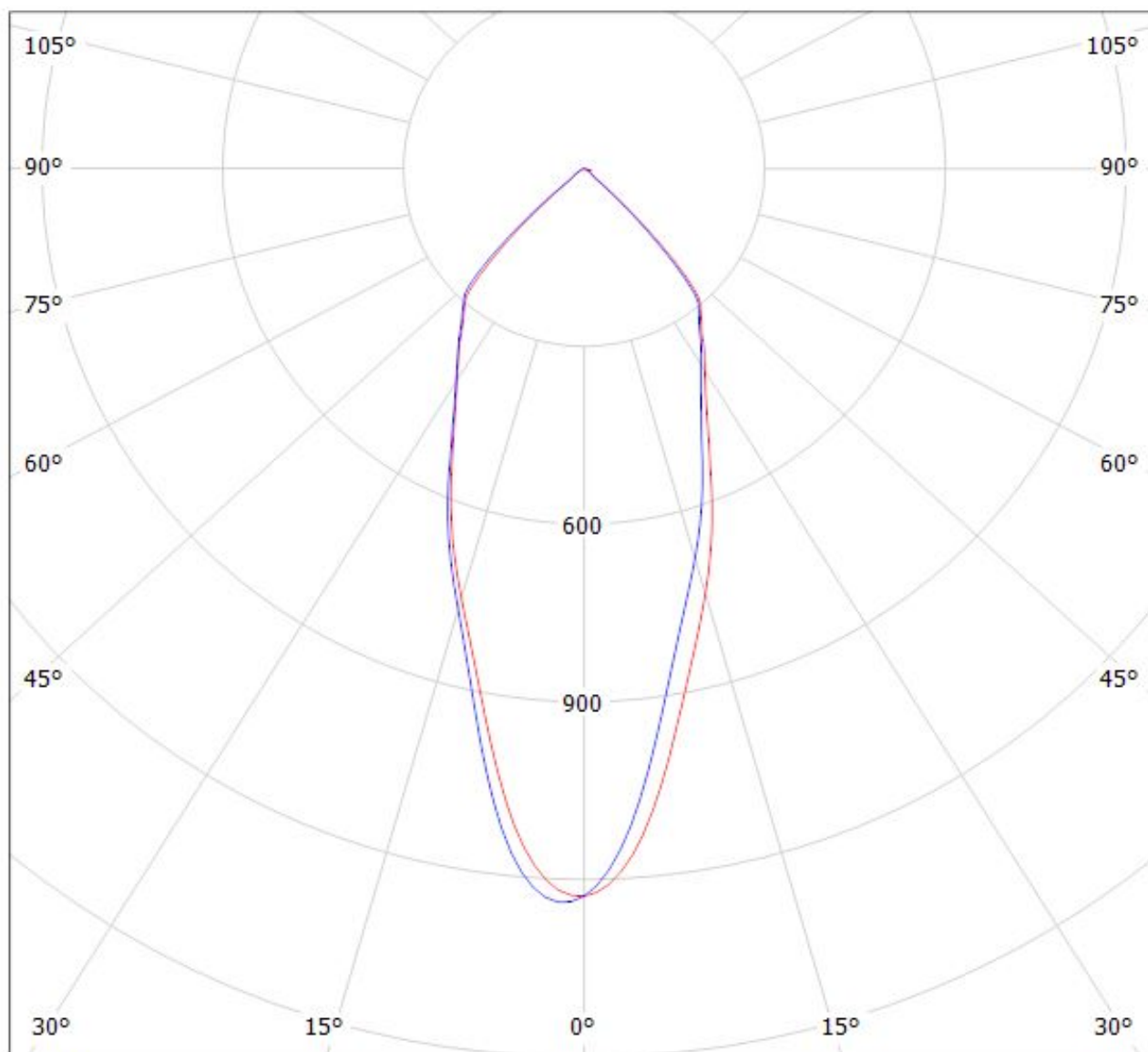

cd/klm

$\eta = 93\%$

— C0 - C180 — C90 - C270

Luminaire: LEDiL Oy F13402_ANGELINA-W_(LG_COB-10W) Eff.93.1%
Lamps: 1 x LG_COB-10W_1024lm@250mA_CCT=5090K_P=9W_I=250mA

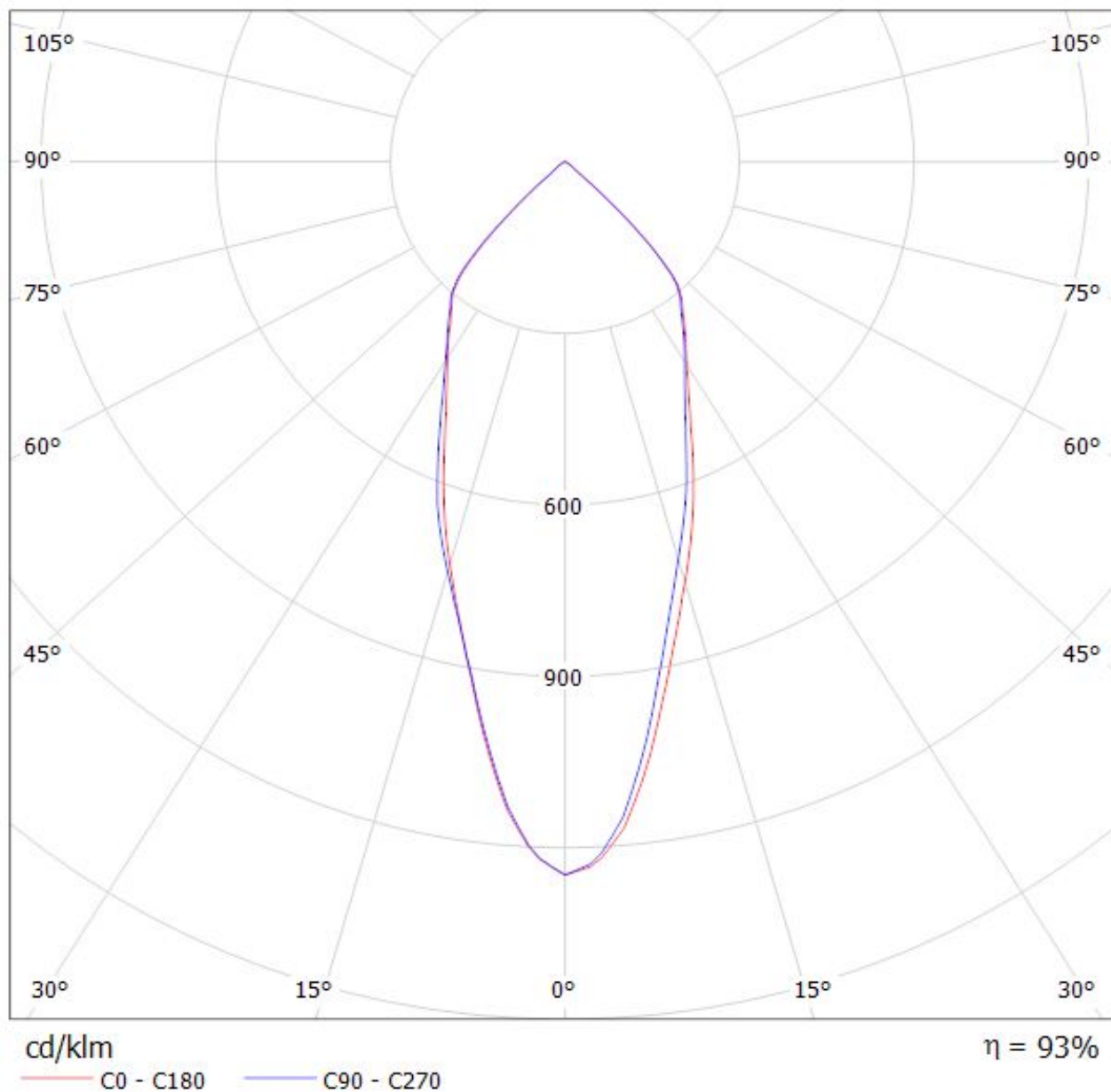

Luminaire: LEDiL Oy F13402_ANGELINA-W_(MEGAZENIGATA) Eff.93.0%

Lamps: 1 x SHARP_MEGAZENIGATA_(GW6DME30NFC)_1238.26lm@250mA_CCT=3000K_P=11.1211W_I=249.8n

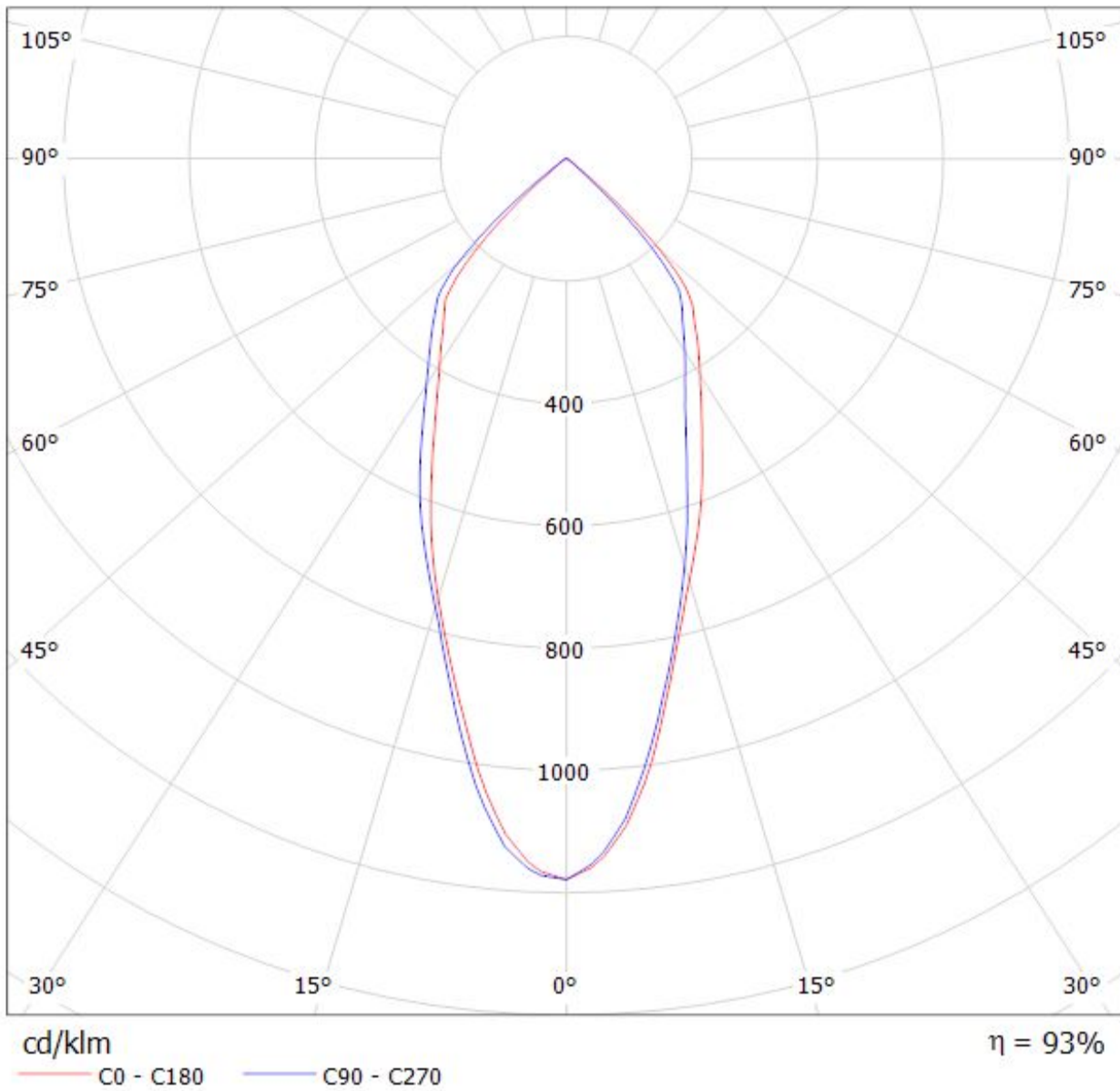

Luminaire: LEDiL Oy F13402_ANGELINA-W_(MEGAZENIGATA) Eff.93.0%
Lamps: 1 x SHARP_MEGAZENIGATA_(GW6DME30NFC)_1238.26lm@250mA_CCT=3000K_P=11.1211W_I=249.8mA

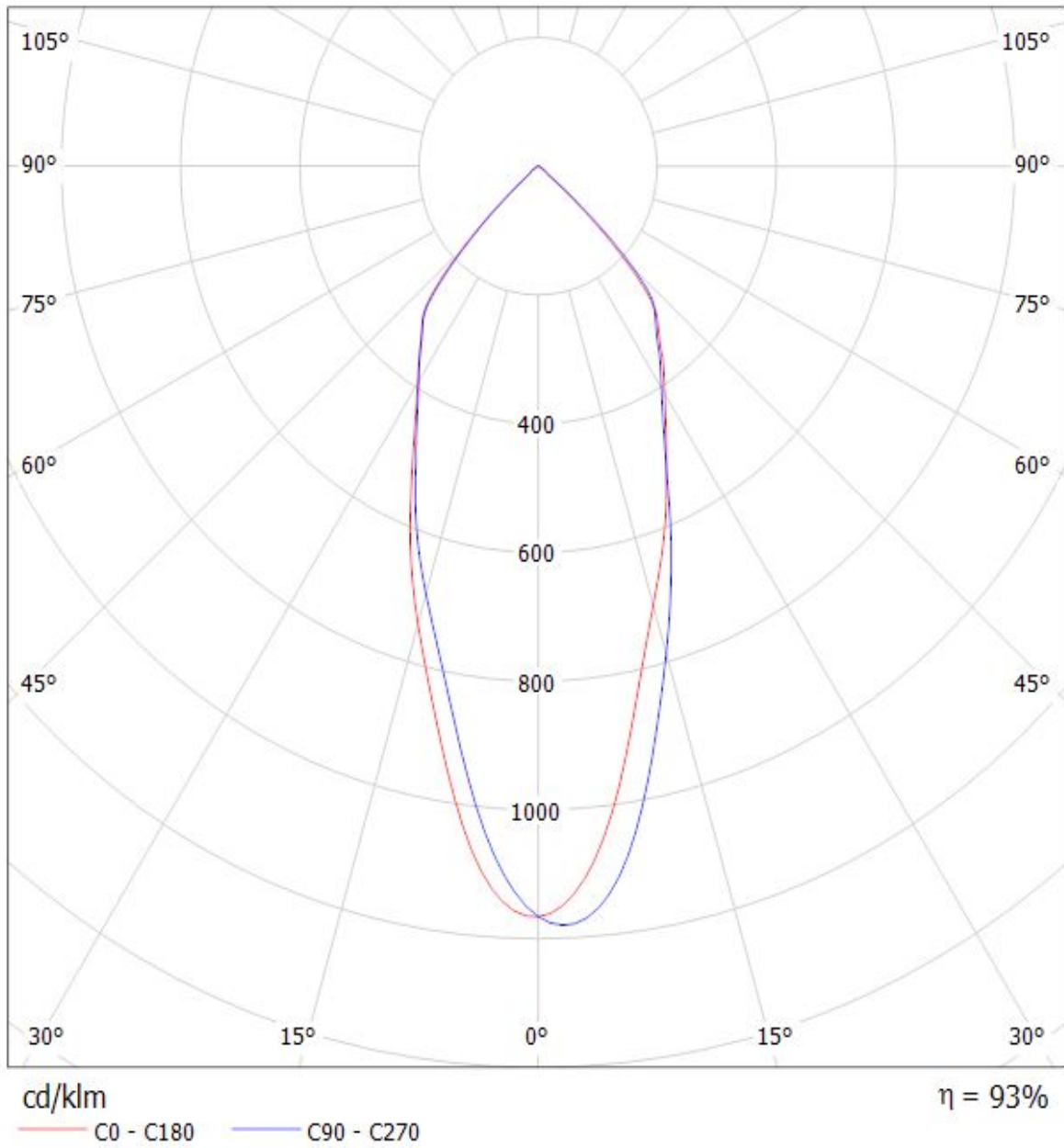

Luminaire: LEDiL Oy F13402_ANGELINA-W_(CLL030) Eff.92.6%

Lamps: 1 x CITIZEN CLL030_(CLL030-1205A5-303H1A7)_758.588lm@250mA_CCT=5090K_P=8.61086W_I=249.8mA

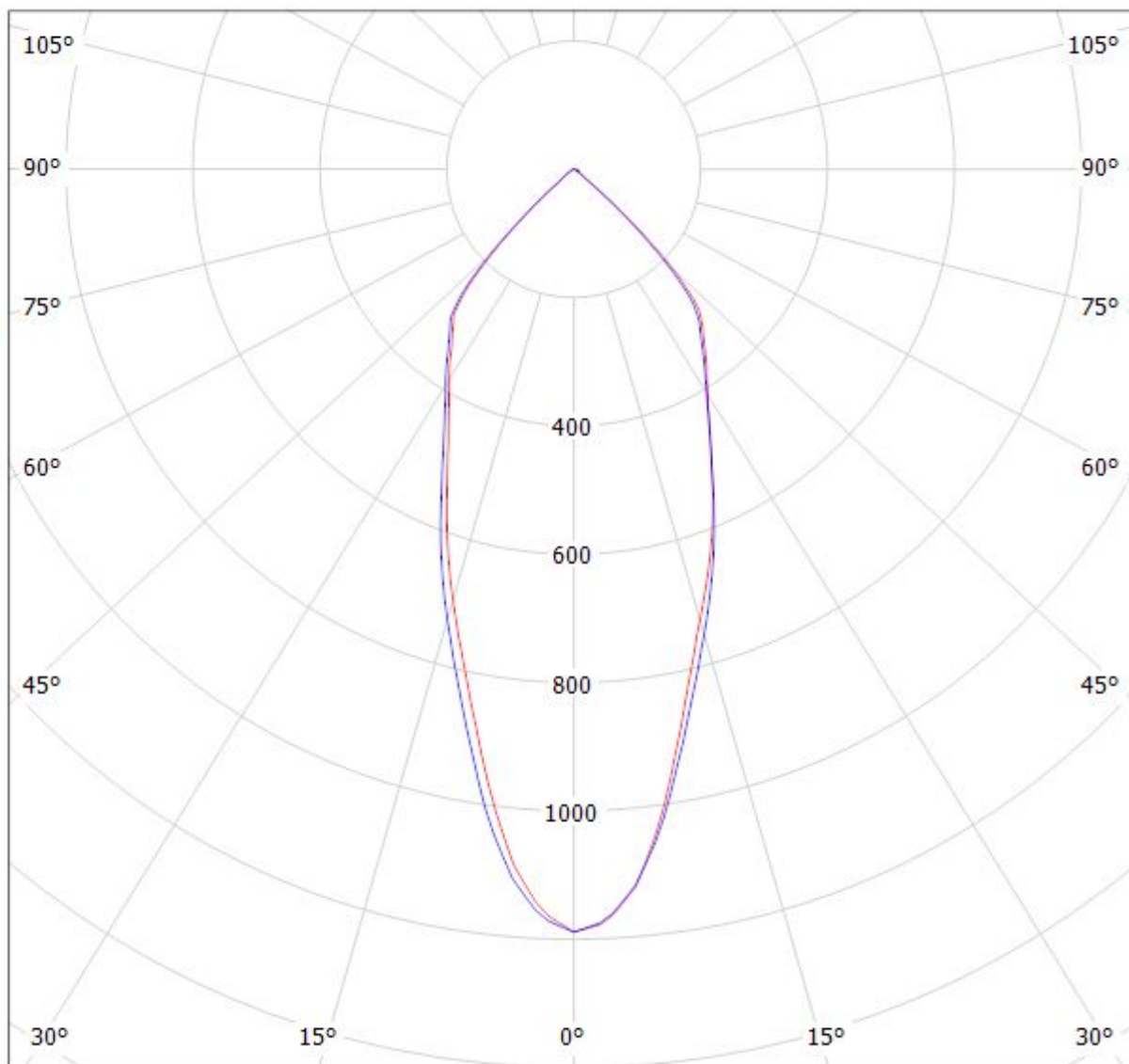

cd/klm

— C0 - C180

— C90 - C270

$\eta = 93\%$

Luminaire: LEDiL Oy F13402_ANGELINA-W_(NSCxJ216A) Eff.93.9%
Lamps: 1 x NICHIA_NSCxJ216A_(NSCLJ216AE)_949.847lm@250mA_CCT=3000K_P=7.96937W_I=249.8mA

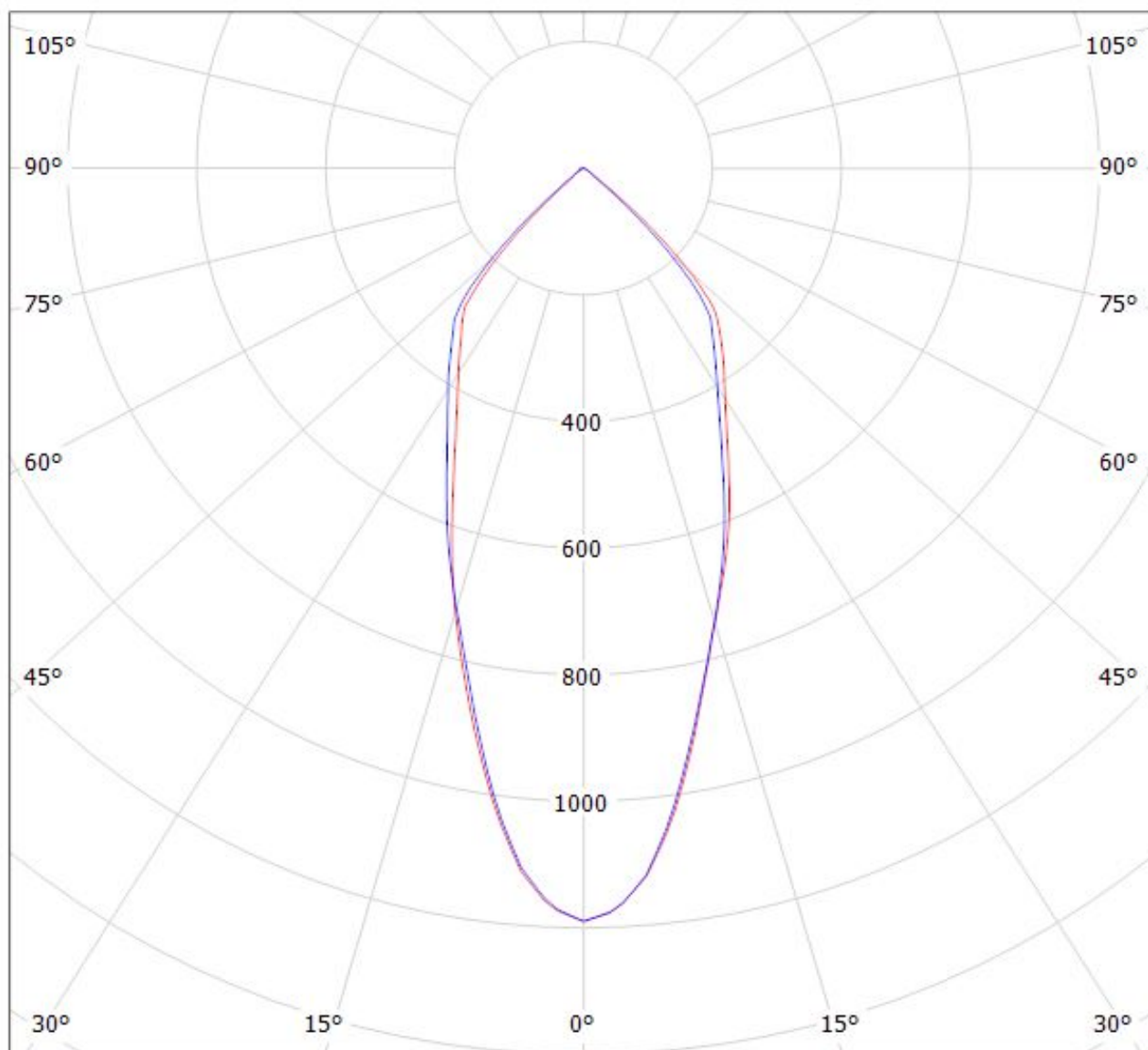

cd/klm

— C0 - C180

— C90 - C270

$\eta = 94\%$

Luminaire: LEDiL Oy F13402_ANGELINA-W_(LUXEON_COB_1208) Eff.93.3%
Lamps: 1 x LUXEON_COB_1208_(LHC1-3080-1208)_1015.13lm@250mA_CCT=3000K_P=8.15972W_I=249.8mA

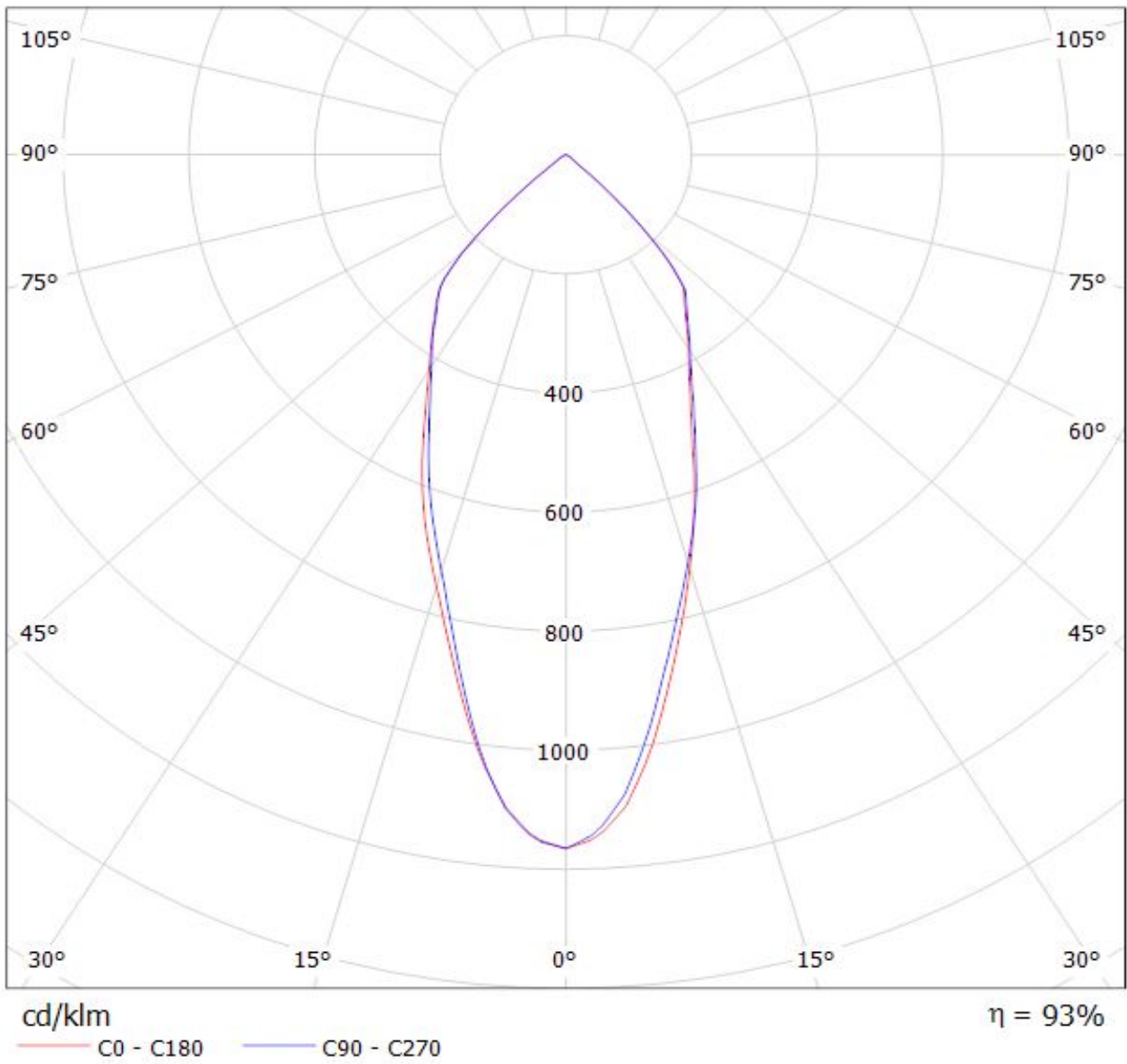

LEDiL Oy C13402_ANGELINA-W_(LUXEON_K12) Eff.94.0% / LDC (Polar)

Luminaire: LEDiL Oy C13402_ANGELINA-W_(LUXEON_K12) Eff.94.0%

Lamps: 1 x LUXEON_K12 (929.543lm@250mA)

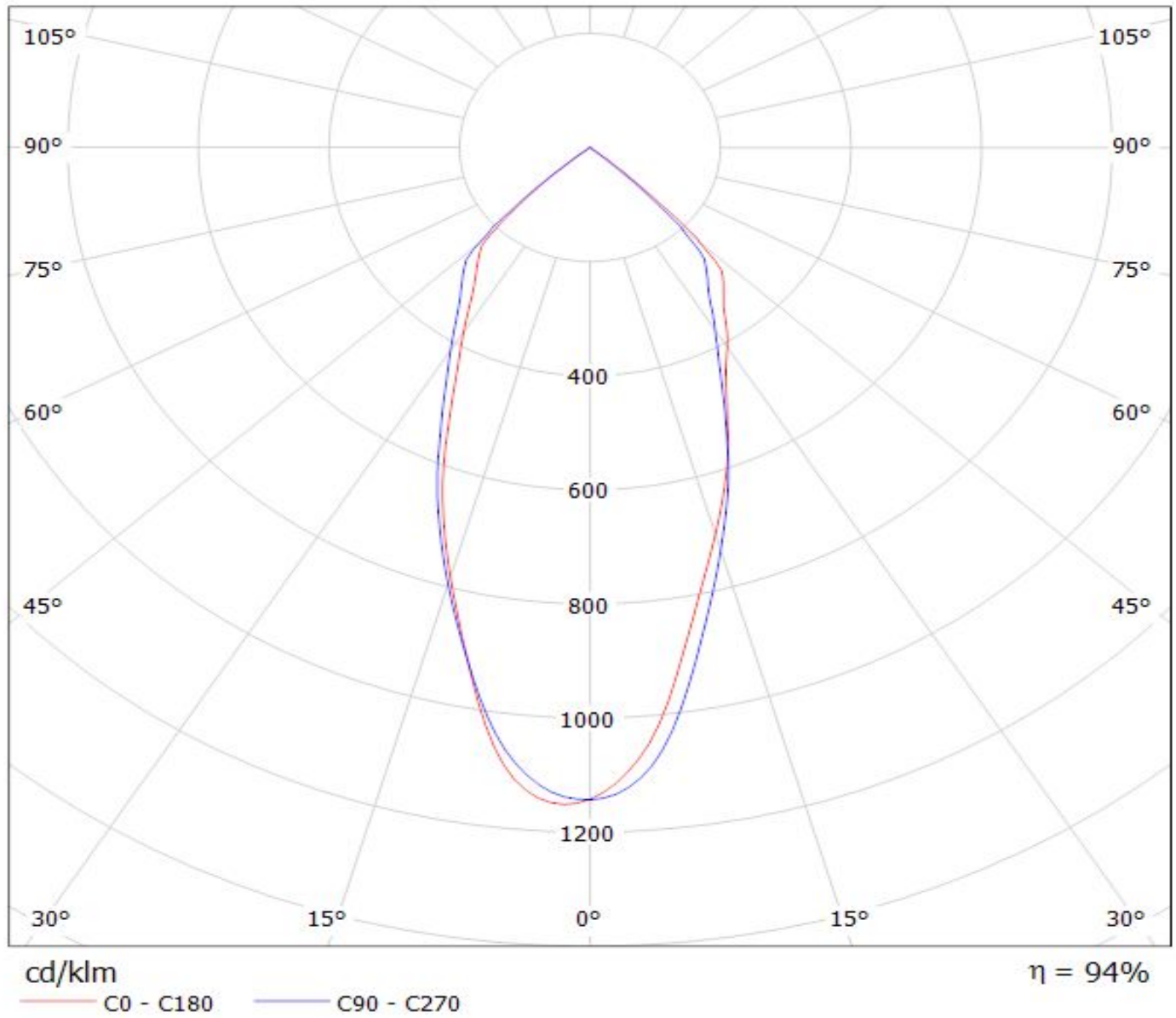

Luminaire: LEDiL Oy F13402_ANGELINA-W_(LUXEON_CoB_1205) Eff: 94 %

Lamps: 1 x LUXEON CoB 1205 (LHC1-3080-1205) 1082lm@250mA CCT=3000K P=8.3W I=250mA

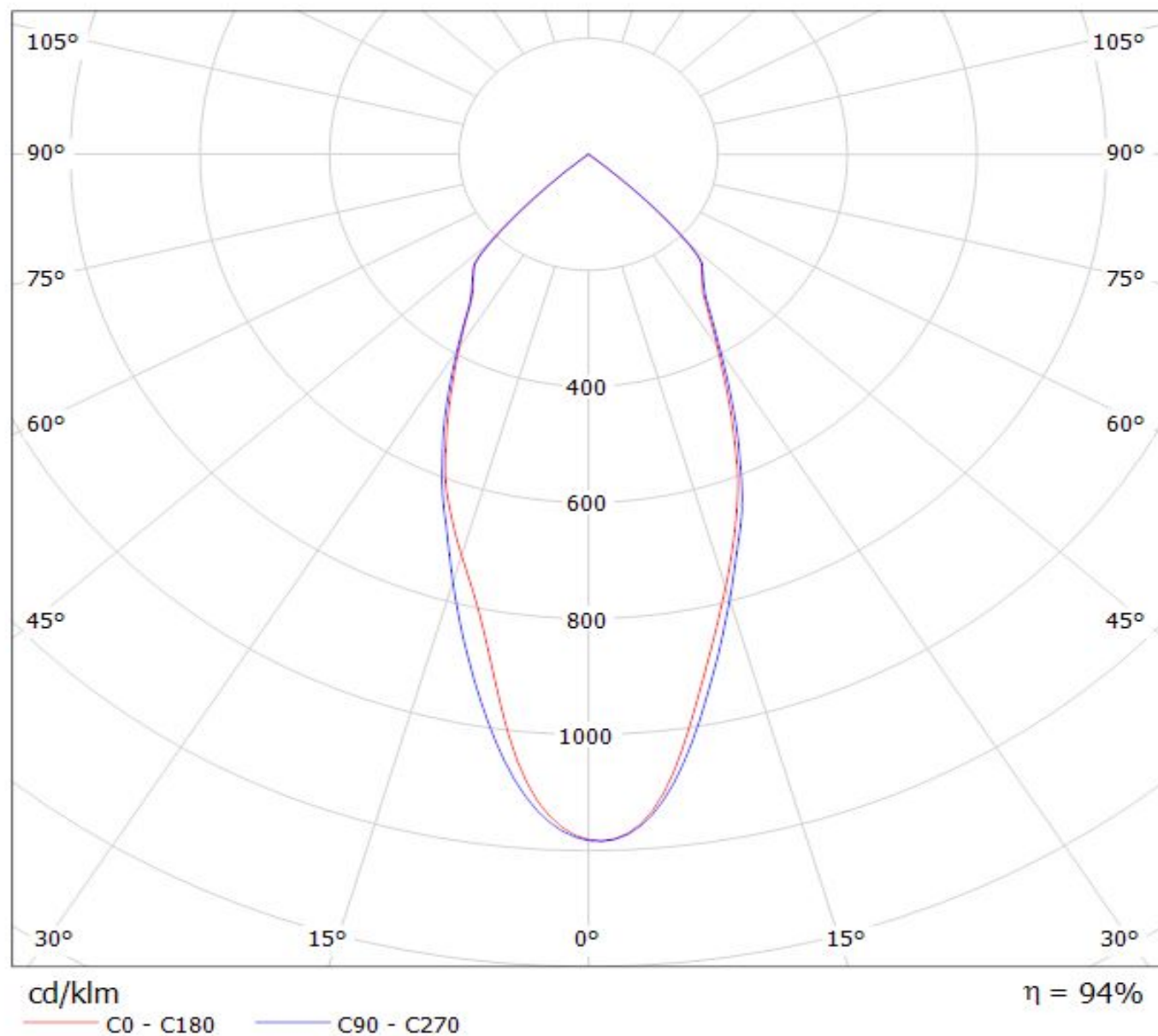

Luminaire: LEDil Oy F13402_ANGELINA-W_(Soleriq_S13) Efficiency=94%
Lamps: 1 x Osram Soleriq S13 (GW KAGHB1.EM) 855lm @ 250mA CCT=3100K P=7.5W I=250mA

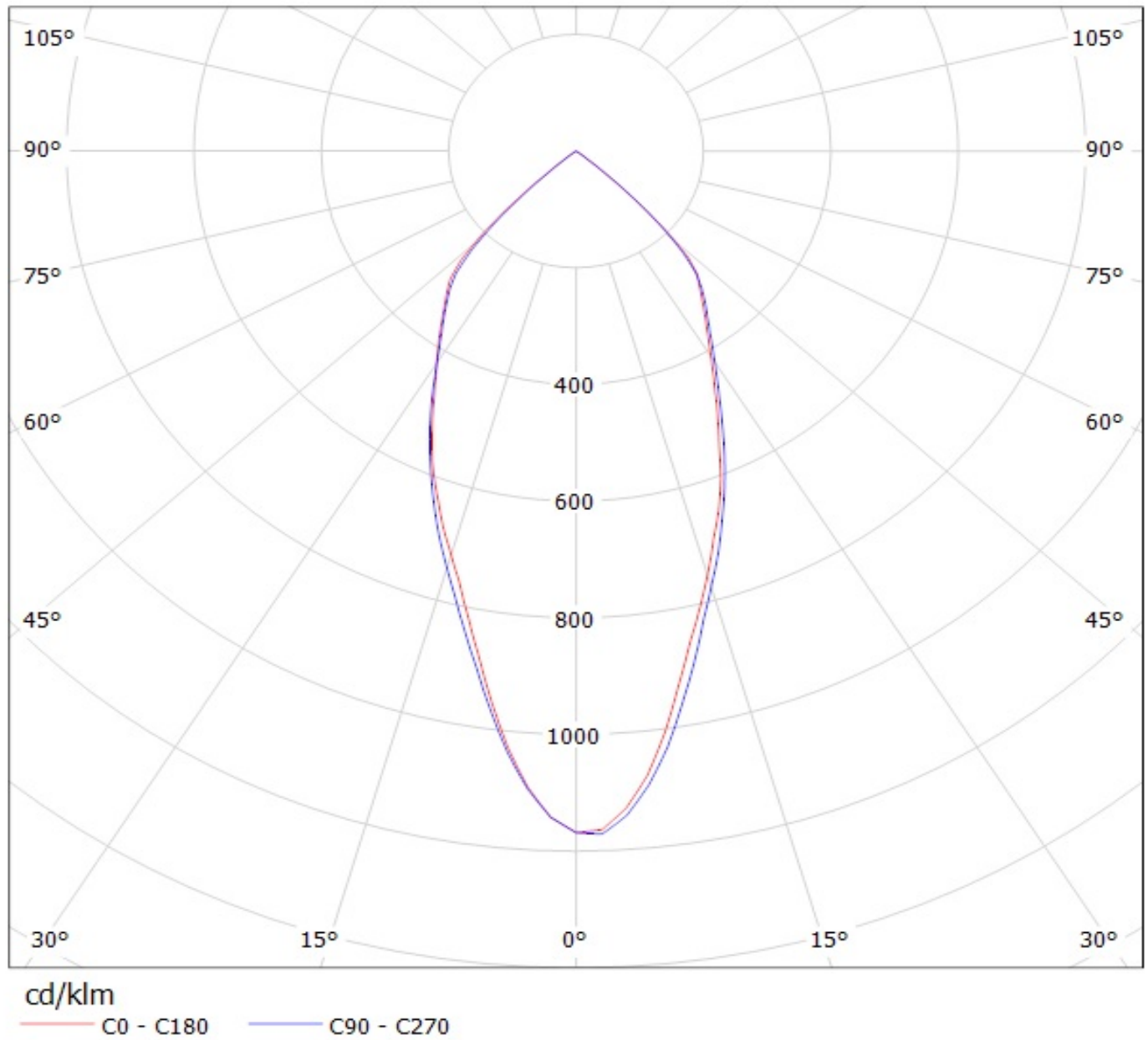

Luminaire: LEDiL Oy F13402_ANGELINA-W_(MegaZenigata) Eff.92.3%
Lamps: 1 x MegaZenigata_GW6DME (518.495lm@100mA)

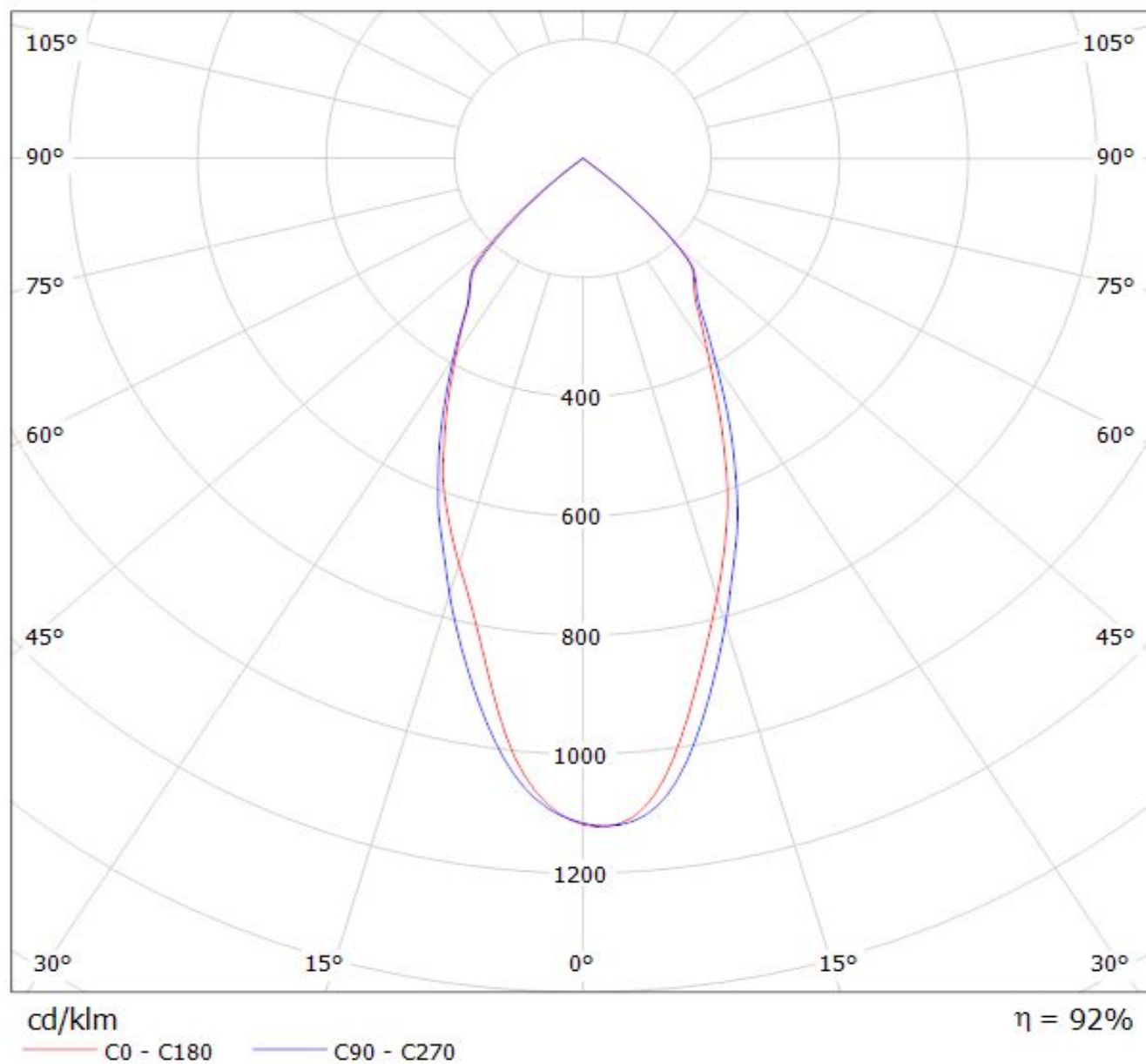

Luminaire: LEDiL Oy F13402_ANGELINA-W_(PrevaLED_Z4) Eff: 93%
Lamps: 1 x Osram_PrevaLED_CORE_Z4_(PL-CORE-3000-830-Z4)_1423.93lm@250mA_P=10.7652W_I=249.9mA

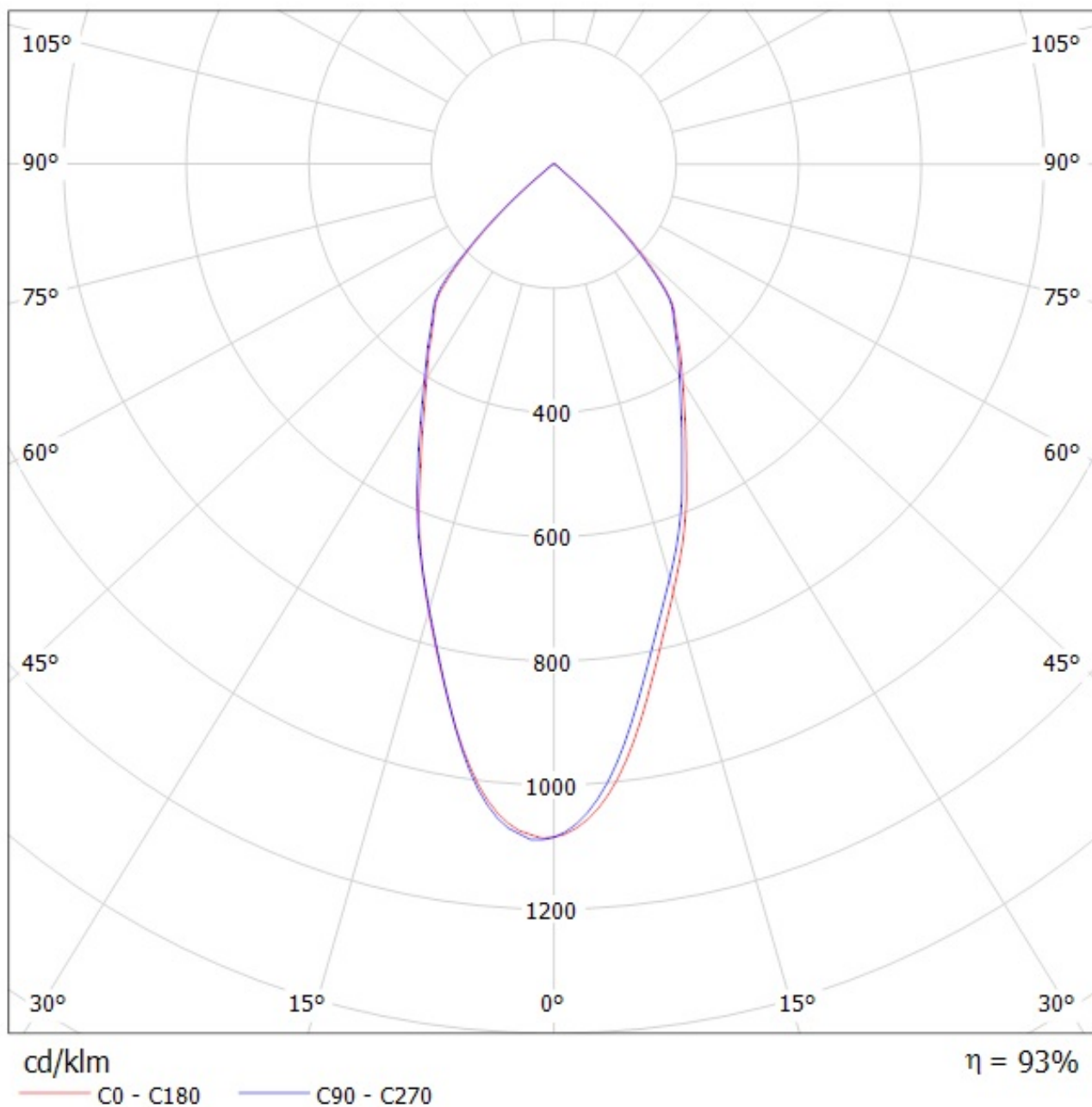

Luminaire: LEDiL Oy F13402_ANGELINA-W_(CXA25) Eff.93.9%

Lamps: 1 x CREE_CXA25_(CXA2530-7C0-T2-N0H)_1151.98lm@250mA_CCT=3000K_P=8.4892W_I=249.8mA

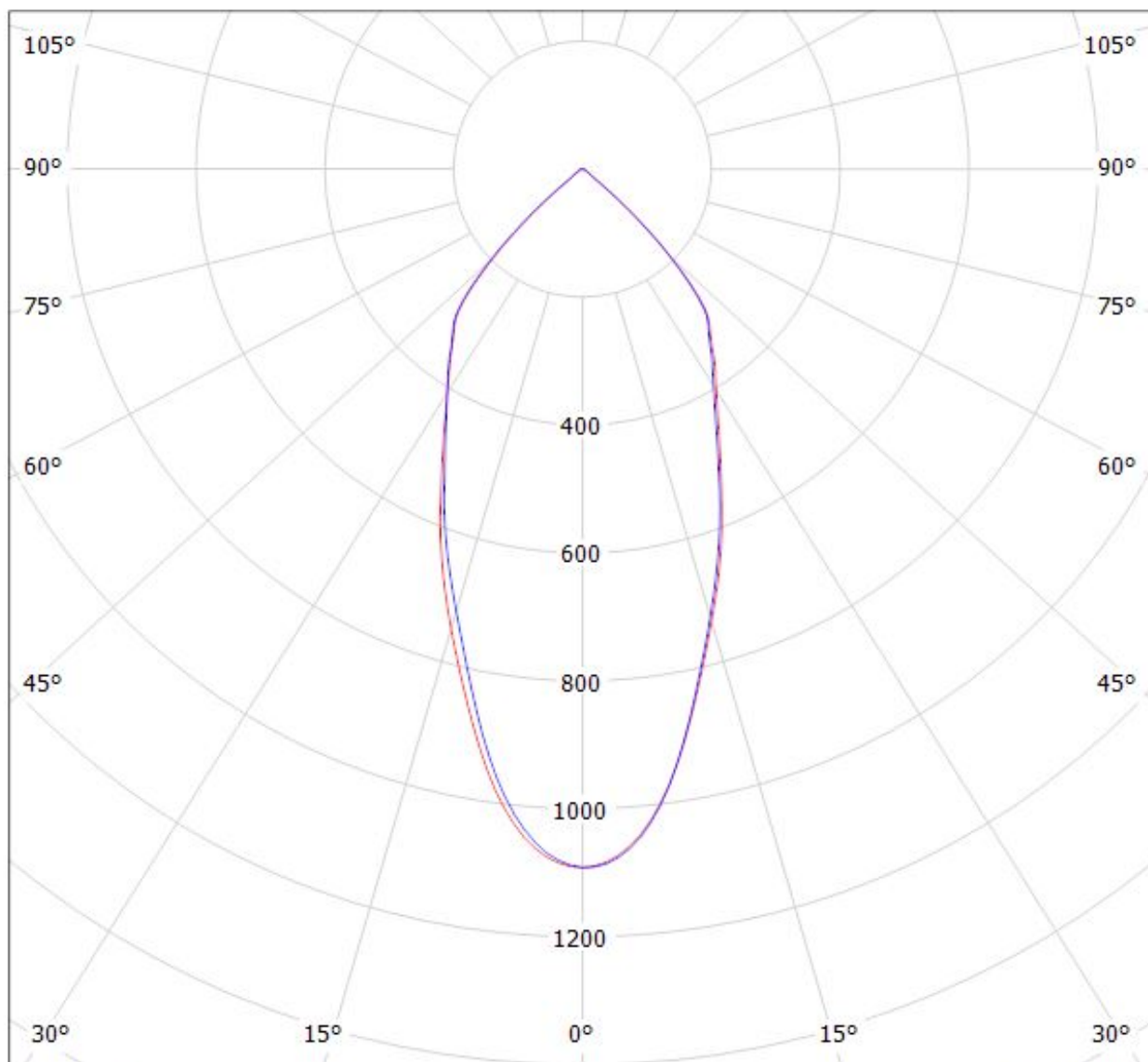

cd/klm

— C0 - C180

— C90 - C270

$\eta = 94\%$

LEDiL Oy C13402_ANGELINA-W_(LUXEON_K16) Eff.93.7% / LDC (Polar)

Luminaire: LEDiL Oy C13402_ANGELINA-W_(LUXEON_K16) Eff.93.7%
Lamps: 1 x LUXEON_K16 (1204.33lm@250mA)

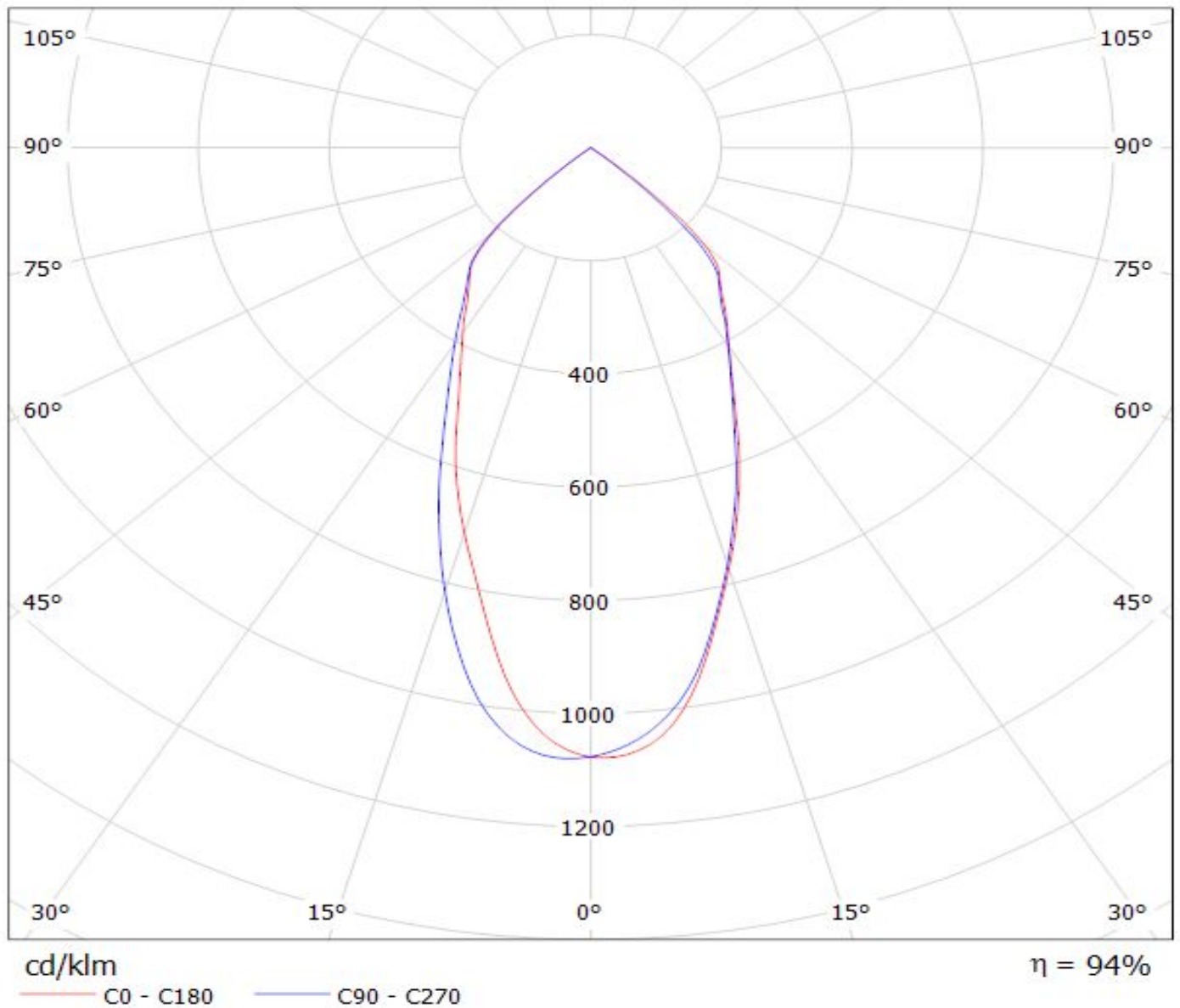

Luminaire: LEDiL Oy F13402_ANGELINA-W_(CXM-14)

Lamps: 1 x LUMINUS_CXM-14_1114.36lm@250mA_P=8.36106W_I=249.8mA

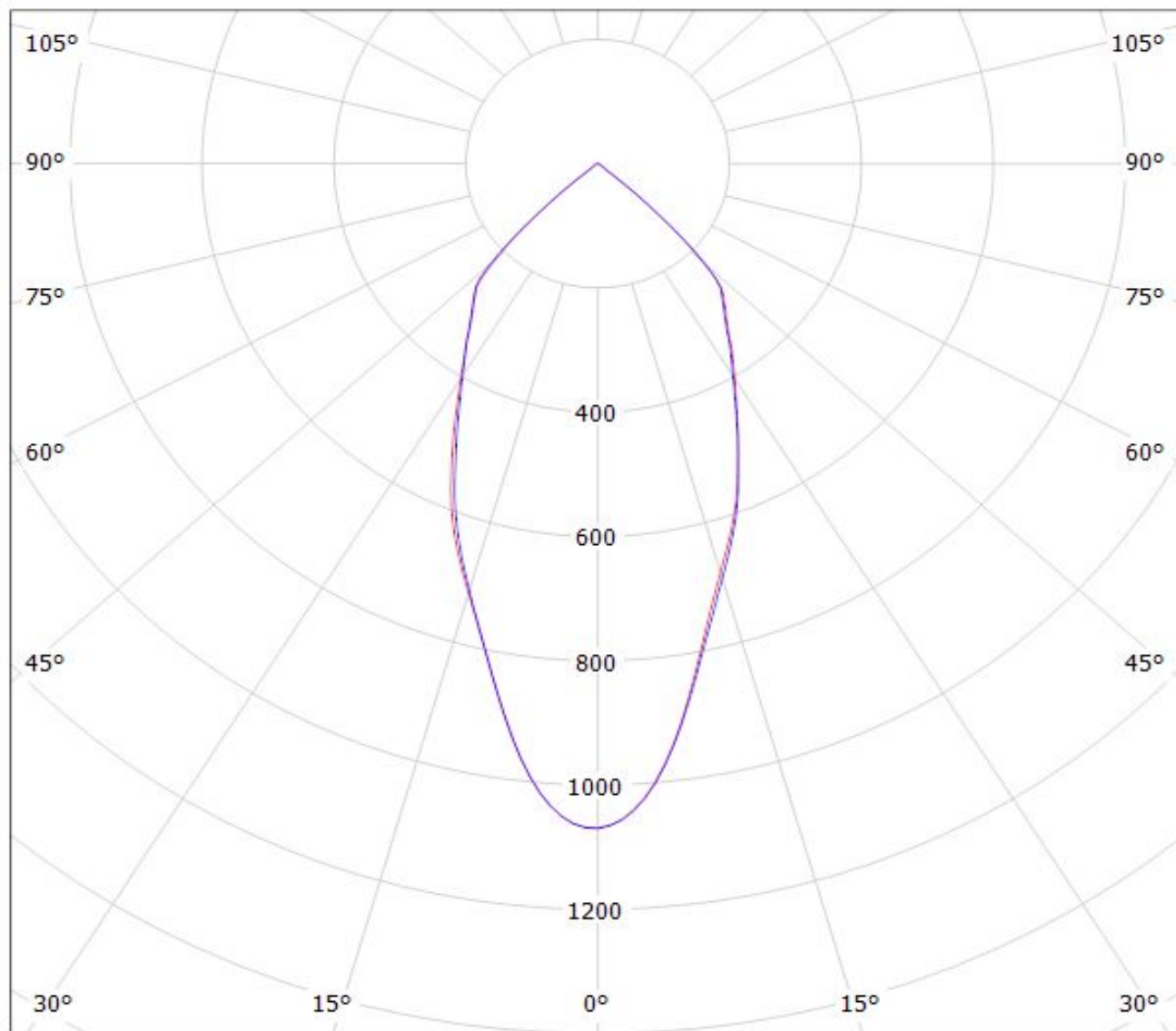

cd/klm

$\eta = 93\%$

— C0 - C180

— C90 - C270

Luminaire: LEDiL F13402_ANGELINA-W

Lamps: 1 x CLL030 740lm@250mA (CLL030-1205A5-303H1A7) CCT:3000K P:8.6W

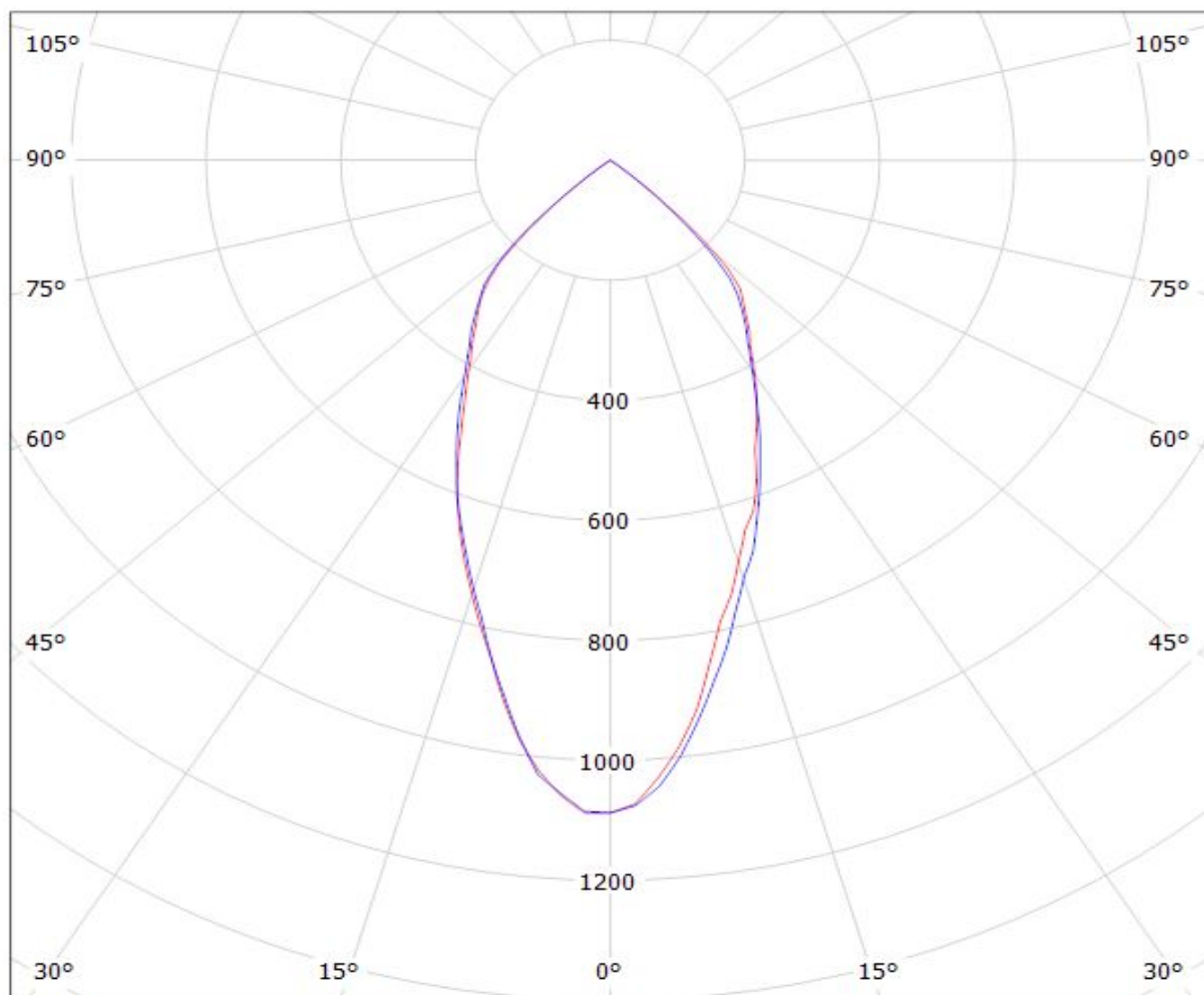

cd/klm

— C0 - C180

— C90 - C270

$\eta = 93\%$

Luminaire: LEDiL Oy F13402_ANGELINA-W_(Luxeon-CoB-1208) Eff: 93 %
Lamps: 1 x Luxeon CoB 1208 (LHC1-3080-1208) 1029lm@250mA CCT=3000K P=8.2W I=250mA

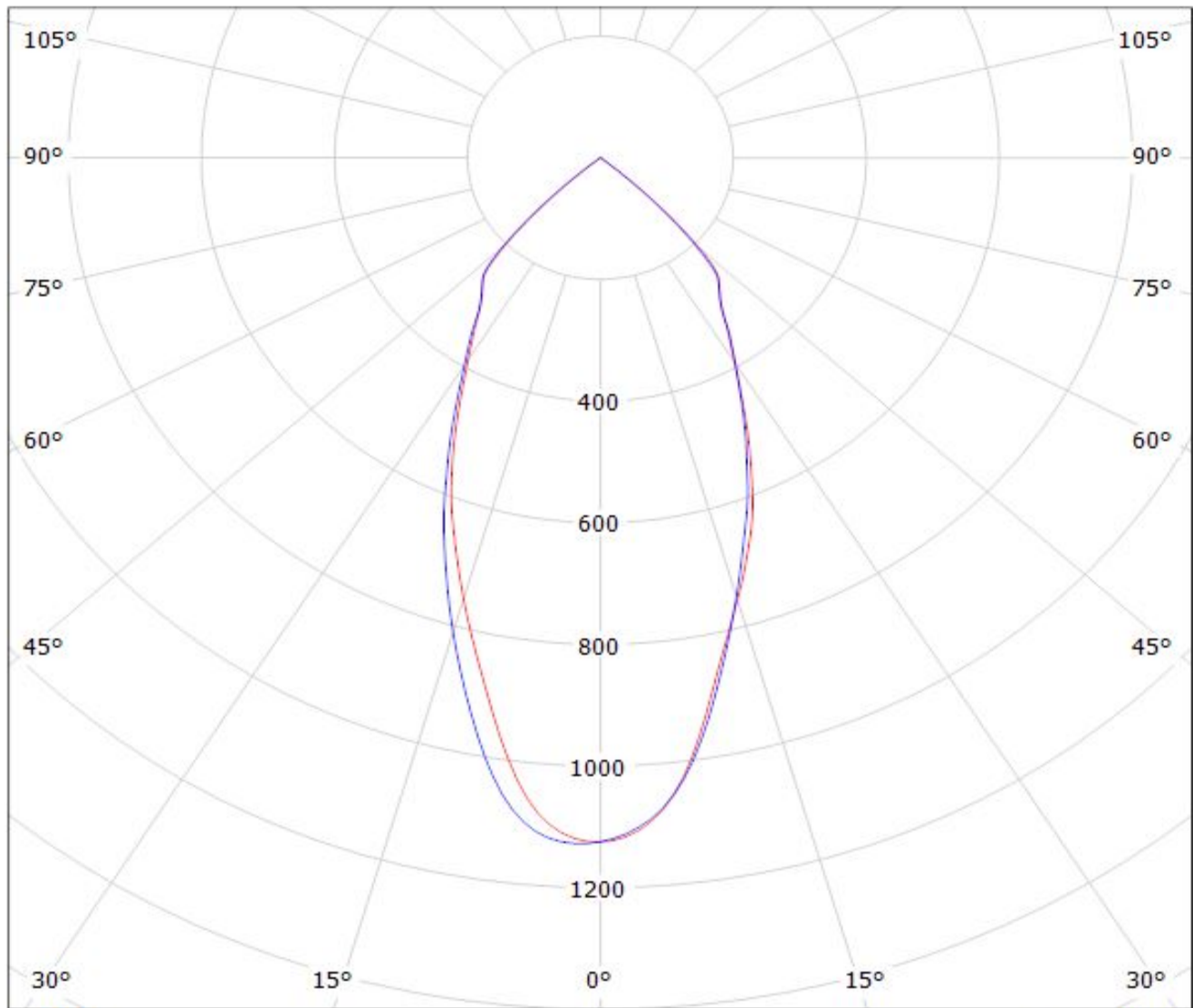

cd/klm

— C0 - C180

— C90 - C270

$\eta = 93\%$

Luminaire: LEDiL Oy F13402_ANGELINA-W_(STARK_SLE_G2_LES19) Eff.91.5%

Lamps: 1 x TRIDONIC STARK SLE G2 LES19 830 CLA 964.643lm@250mA CCT=3000K P=8W I=250mA

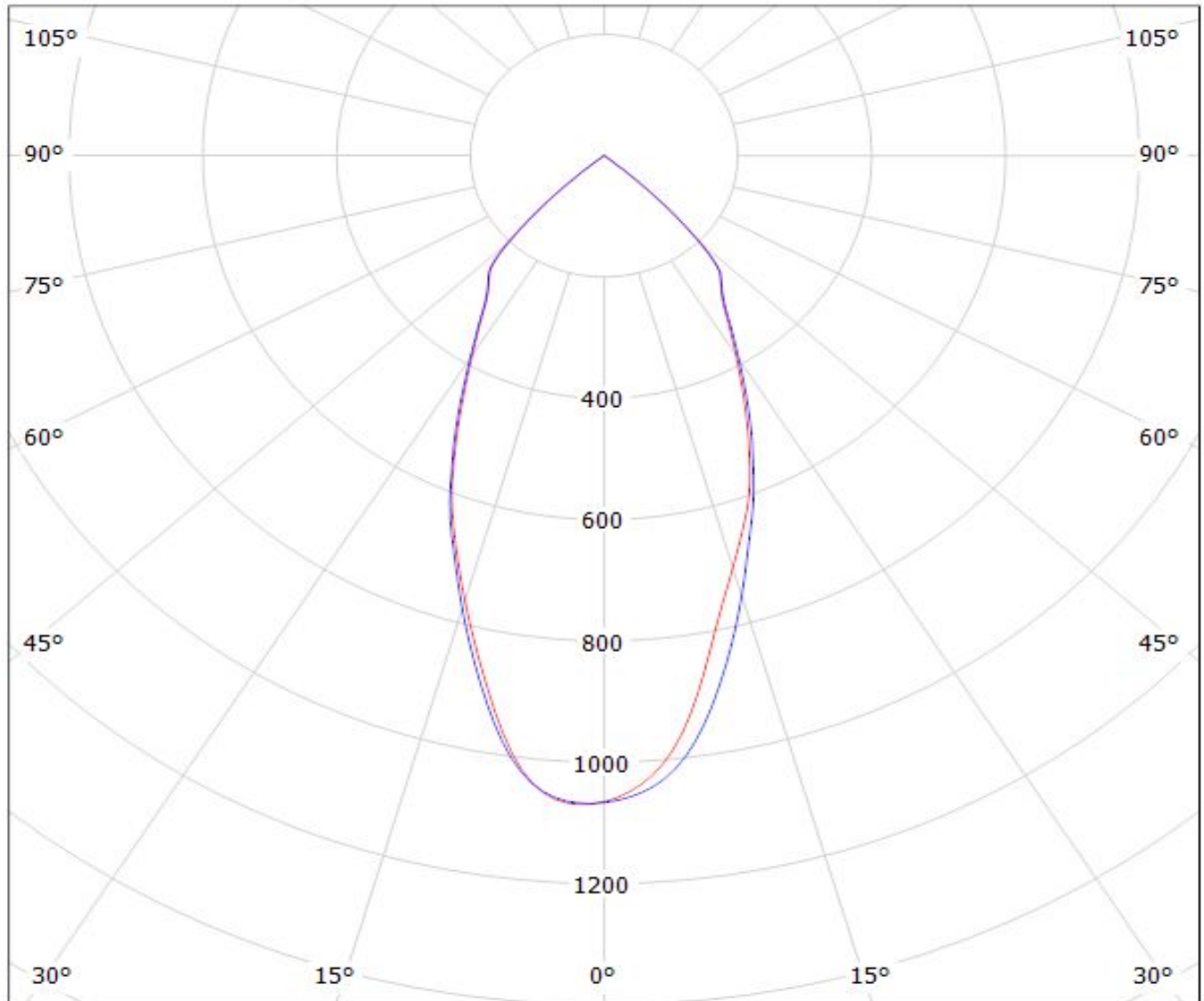

cd/klm

— C0 - C180

— C90 - C270

$\eta = 91\%$

Luminaire: LEDiL Oy F13402_ANGELINA-W_(SOLERIQ_S19_&_TE_2213407-2)

Lamps: 1 x OSRAM_SOLERIQ_S19_(GW_KAHJB1.EM)_1393.62lm@250mA_CCT=3000K_P=10.5683W_I=249.8mA

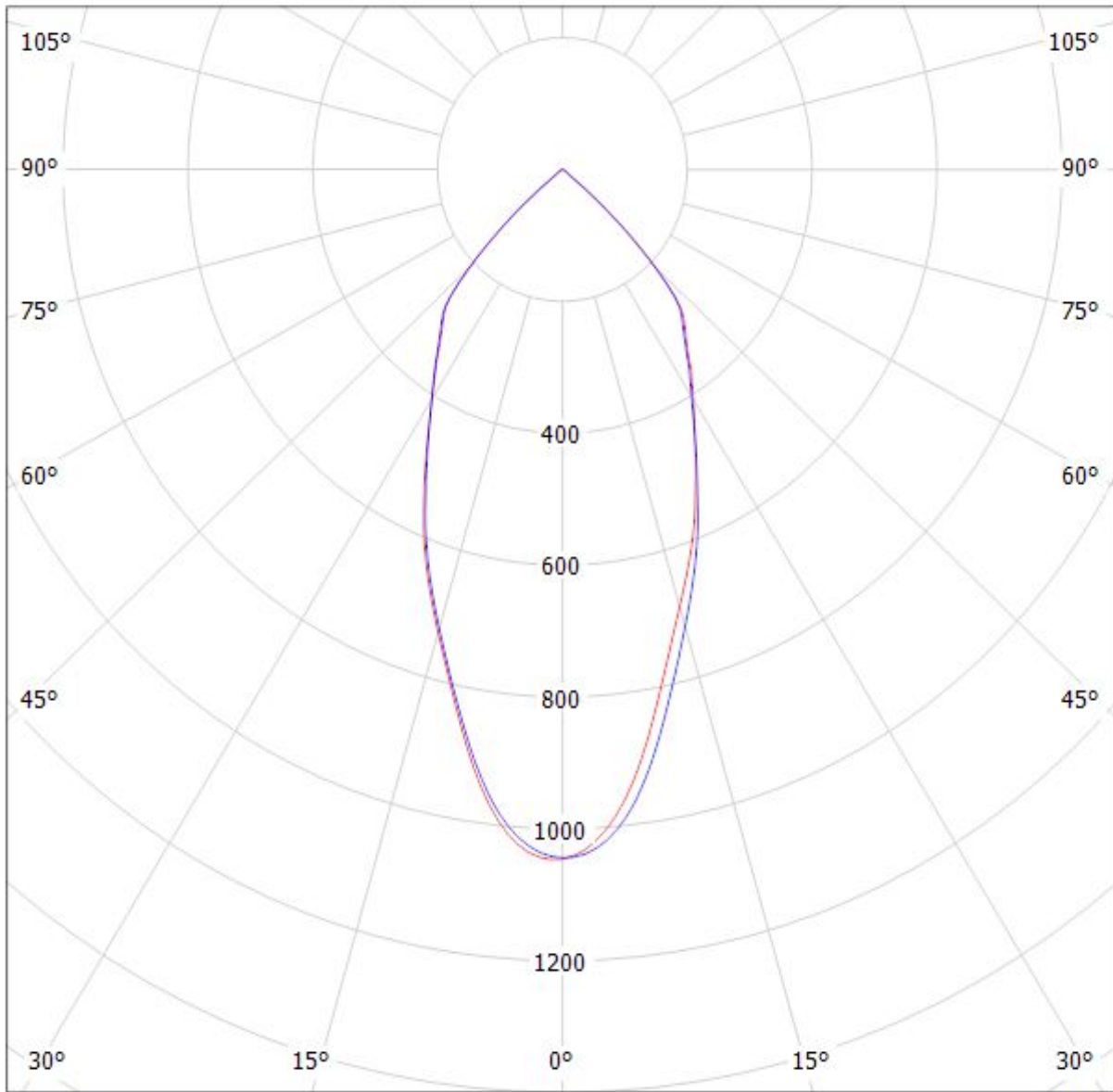

cd/klm

— C0 - C180 — C90 - C270

$\eta = 93\%$

Luminaire: LEDiL Oy F13402_ANGELINA-W_(LEP-2000-827-C-AC)
Lamps: 1 x OSRAM PrevaLED Core AC (LEP-2000-827-C-AC)

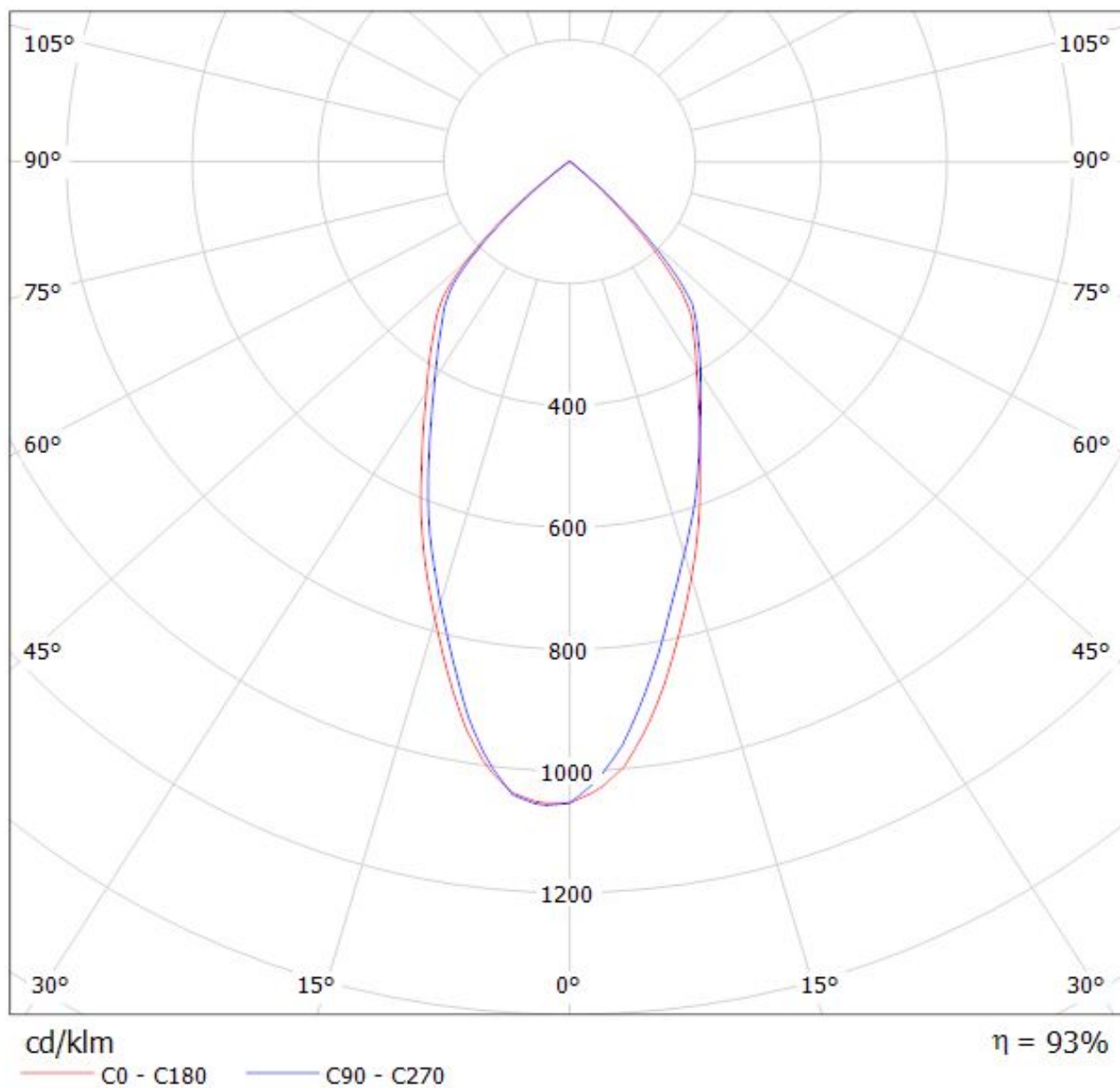

Luminaire: LEDiL Oy F13402_ANGELINA-W_(FORTIMO_2000) Eff.90.5%

Lamps: 1 x PHILIPS Fortimo LED SLM 3000 28W/830 L19 G3 665.774lm@250mA CCT=3000K P=6W I=250mA

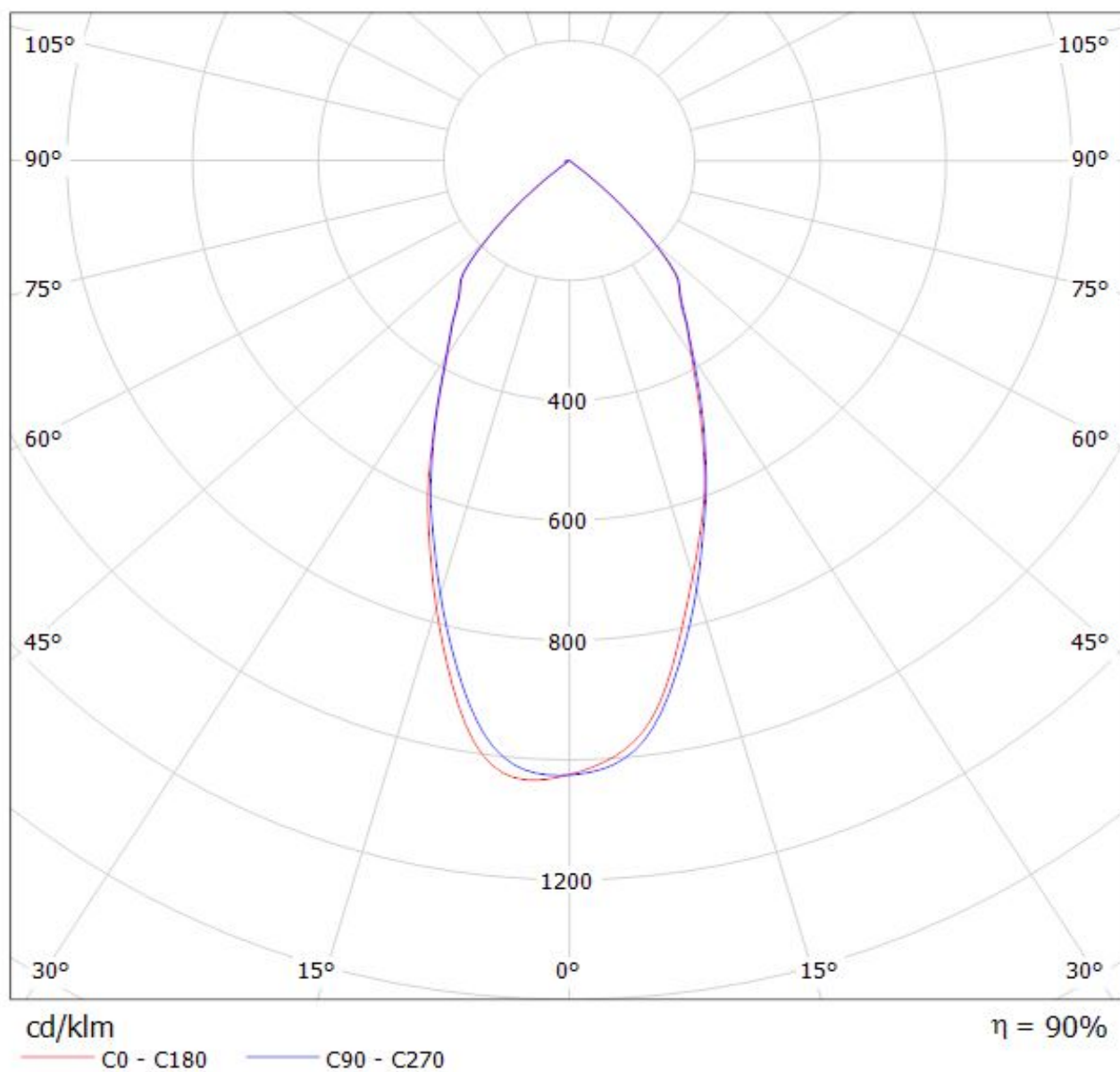

Luminaire: LEDiL Oy F13402_ANGELINA-W_(FORTIMO_3000) Eff.90.2%

Lamps: 1 x PHILIPS Fortimo LED SLM 3000 28W/830 L19 G3 1046.76lm@250mA CCT=3000K P=9W I=250mA

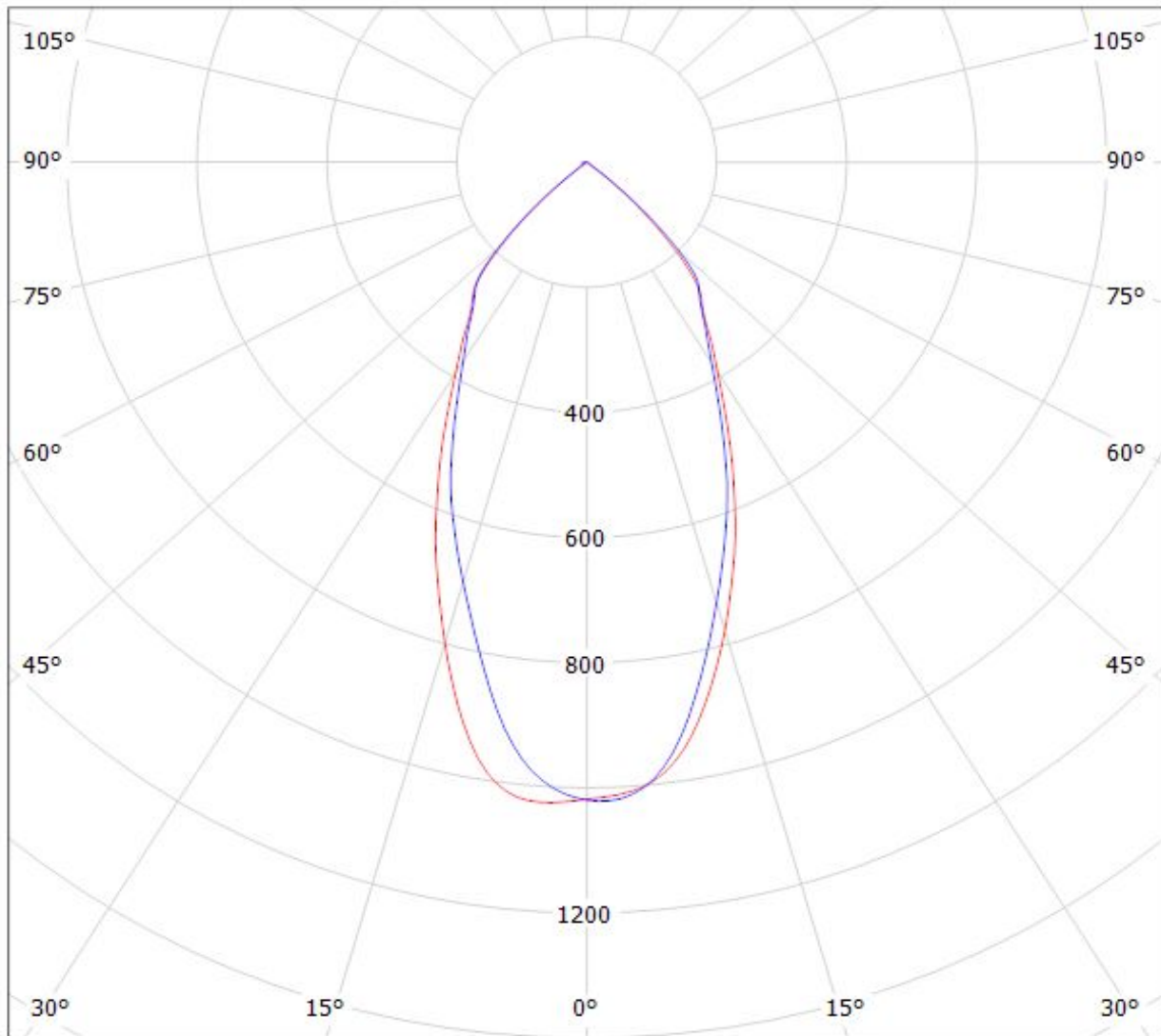

cd/klm

$\eta = 90\%$

— C0 - C180

— C90 - C270

Luminaire: LEDiL Oy F13402_ANGELINA-W_(PrevaLED_LES19)

Lamps: 1 x PrevaLED_LES19_(PL-CORE-2000-830-Z3)_1333.47lm@250mA_P=10.4584W_I=249.8mA

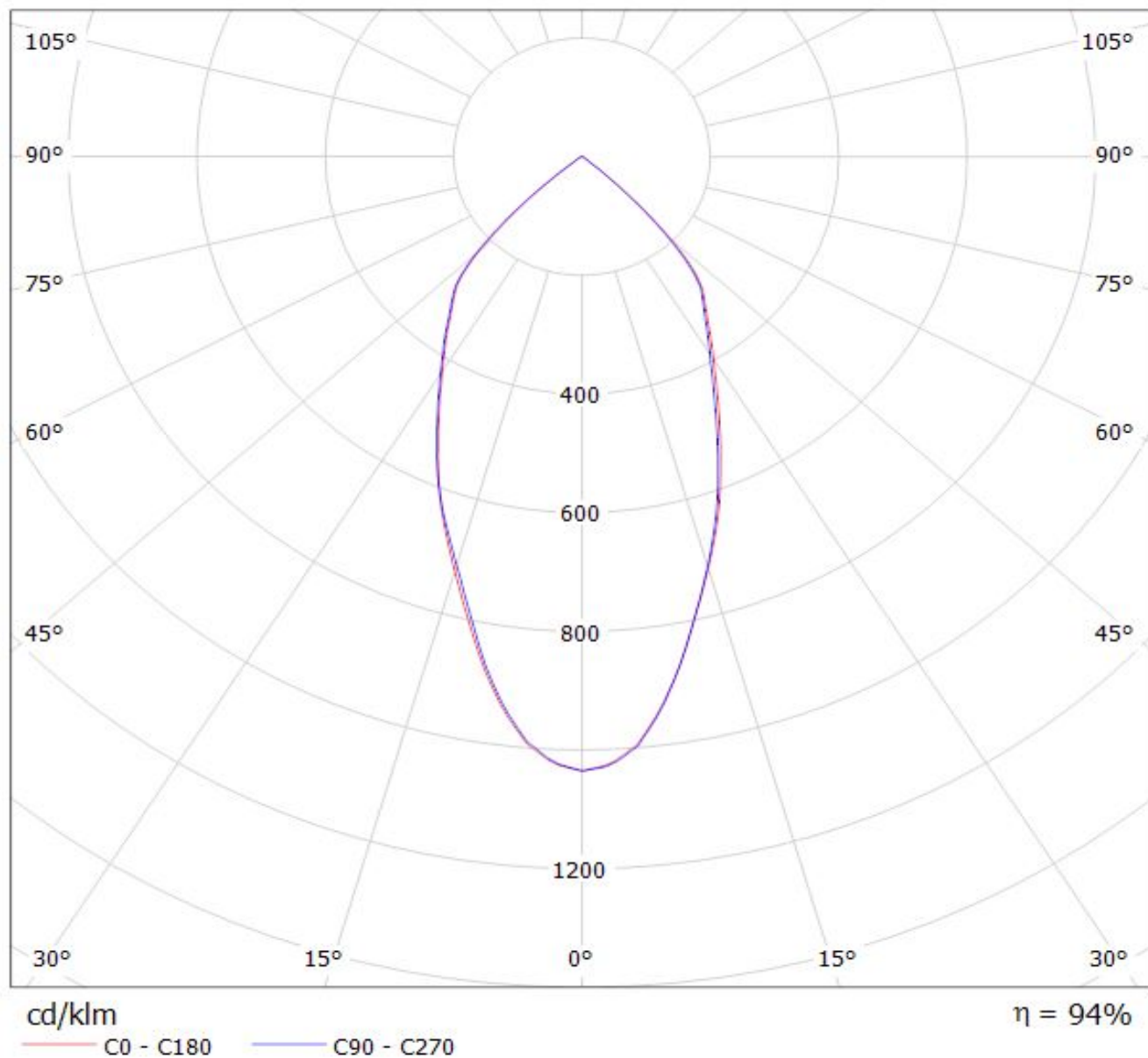

Luminaire: LEDiL Oy F13402_ANGELINA-W_(WU-M-461-827)

Lamps: 1 x Vossloh_WU-M-461-827_773.276lm@250mA_P=6.27423W_I=249.8mA

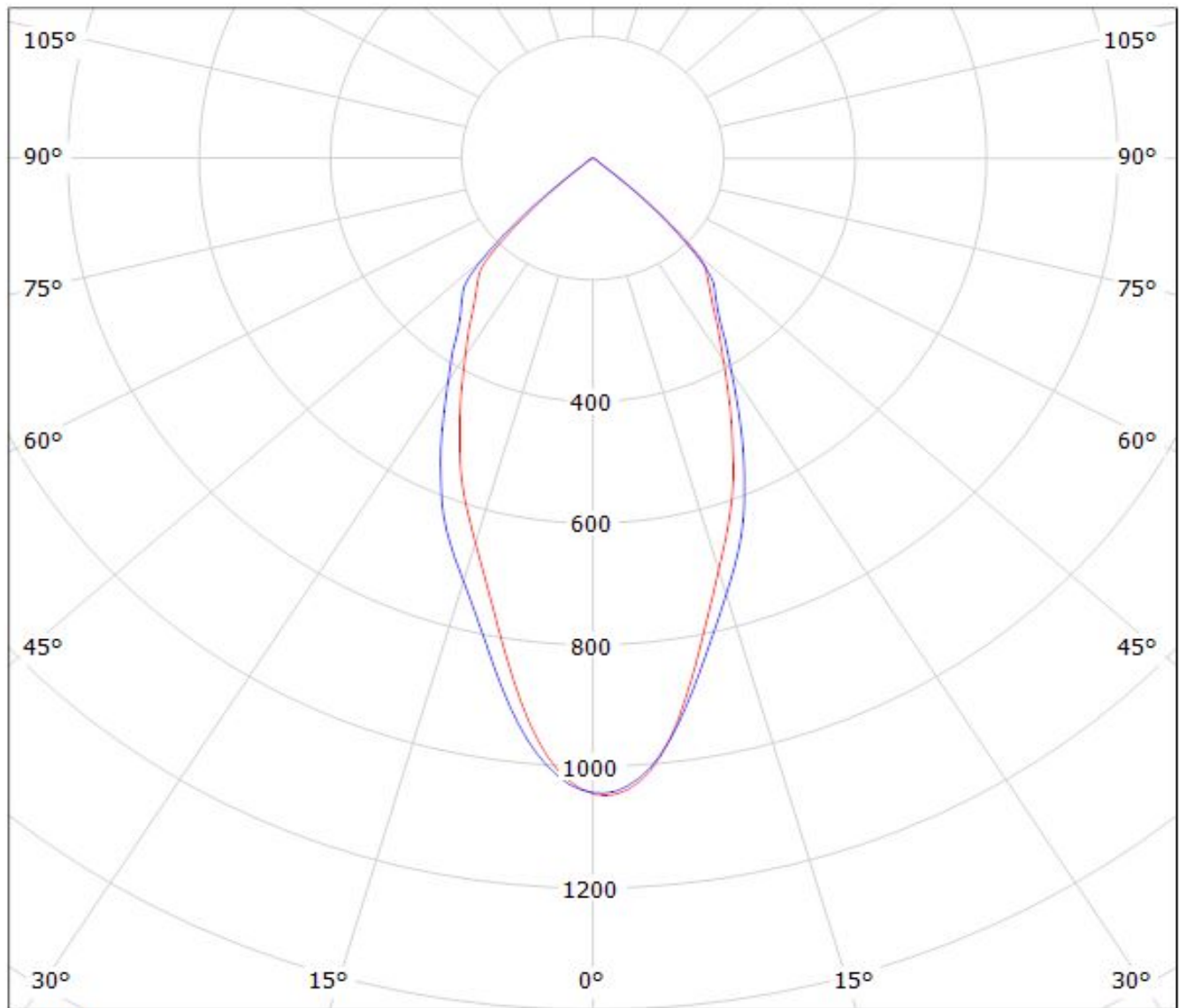

cd/klm

— C0 - C180

— C90 - C270

$\eta = 93\%$

Luminaire: LEDiL Oy F13402_ANGELINA-W_(WU-M-484)

Lamps: 1 x Vossloh_Schwabe-WU-M-484_(WU-M-484-830)_657.125lm@250mA_P=5.59976W_I=249.9mA

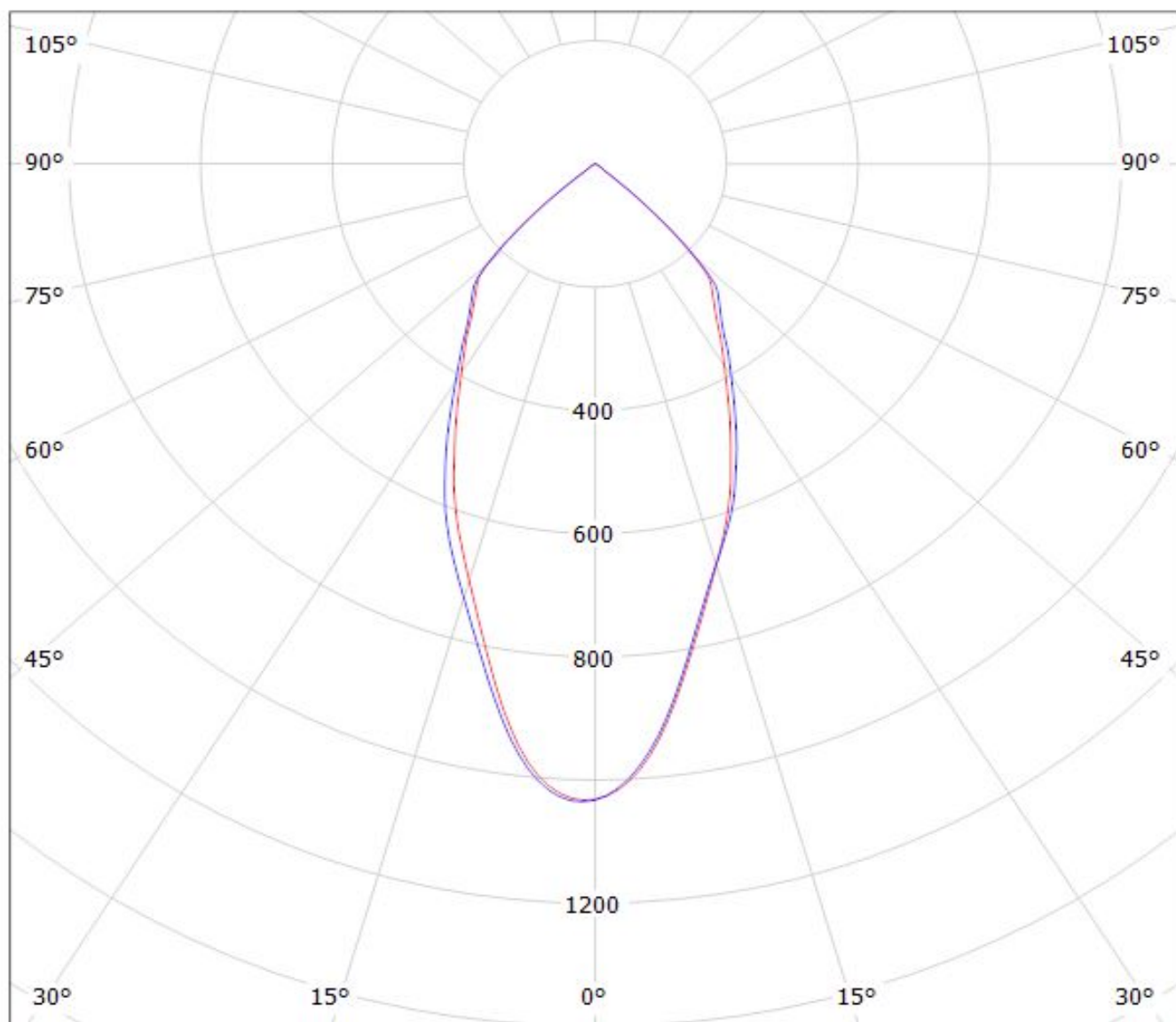

cd/klm

— C0 - C180

— C90 - C270

$\eta = 93\%$

Luminaire: LEDiL Oy F13402_ANGELINA-W_(COB-LC026B) Eff.92.4%

Lamps: 1 x SAMSUNG_COB-LC026B_(SPHWWTHDNC25YHV52F)_1136.23lm@250mA_P=8.23191W_I=249.8mA

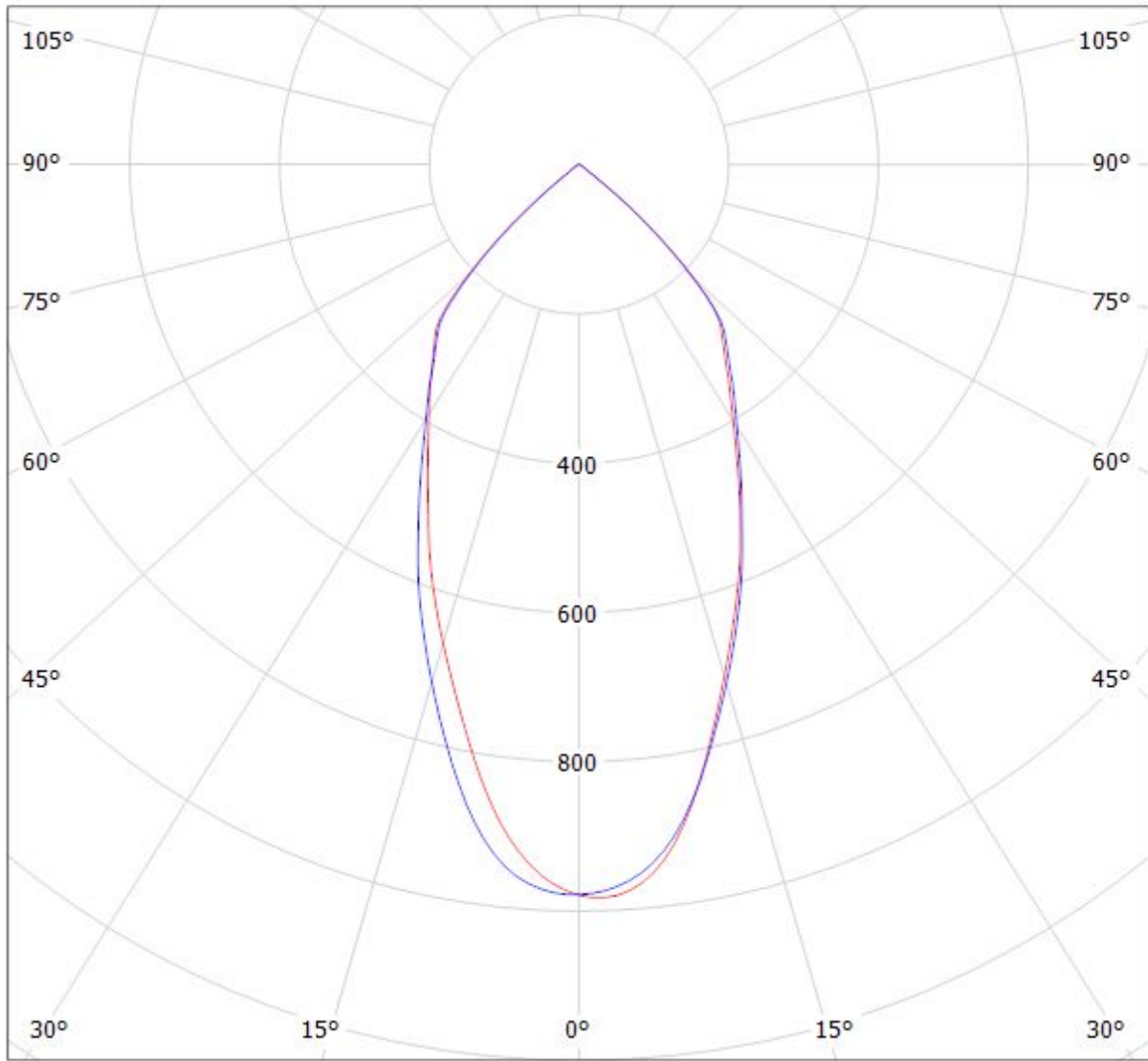

cd/klm

— C0 - C180 — C90 - C270

$\eta = 92\%$

Luminaire: LEDiL Oy F13402_ANGELINA-W_(SLE_G3_LES19) Eff.92.2%

Lamps: 1 x TRIDONIC_STARK_SLE_G3_LES19_(STARK-SLE-G3-LES19-2000-840-CLA)_1058.33lm@250mA_P=8.32833W_I=249.8mA

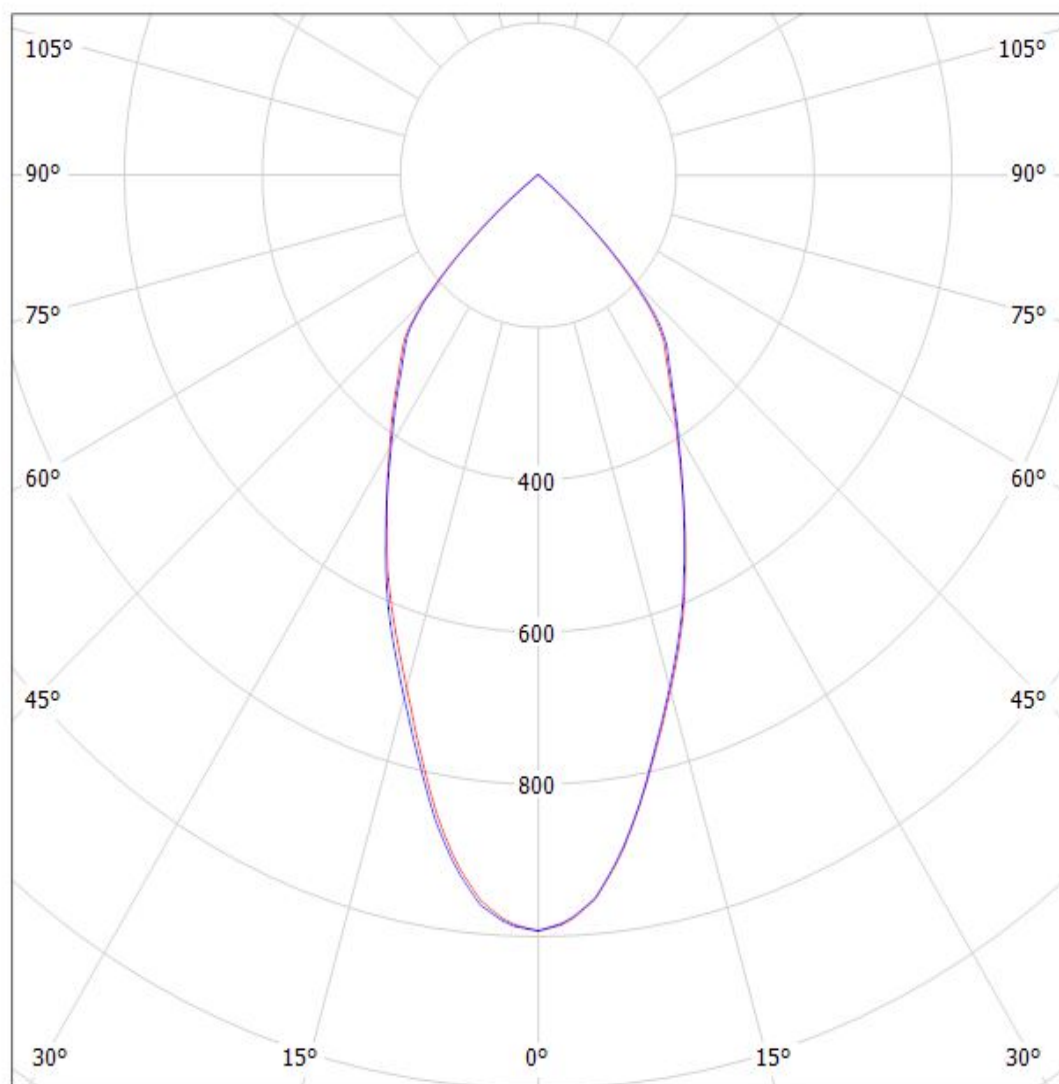

cd/klm

— C0 - C180

— C90 - C270

$\eta = 92\%$

Luminaire: LEDiL Oy F13402_ANGELINA-W_(NSBxL121A)

Lamps: 1 x Nichia_NSBxL121A_914.478lm@250mA_P=7.56872W_I=249.9mA

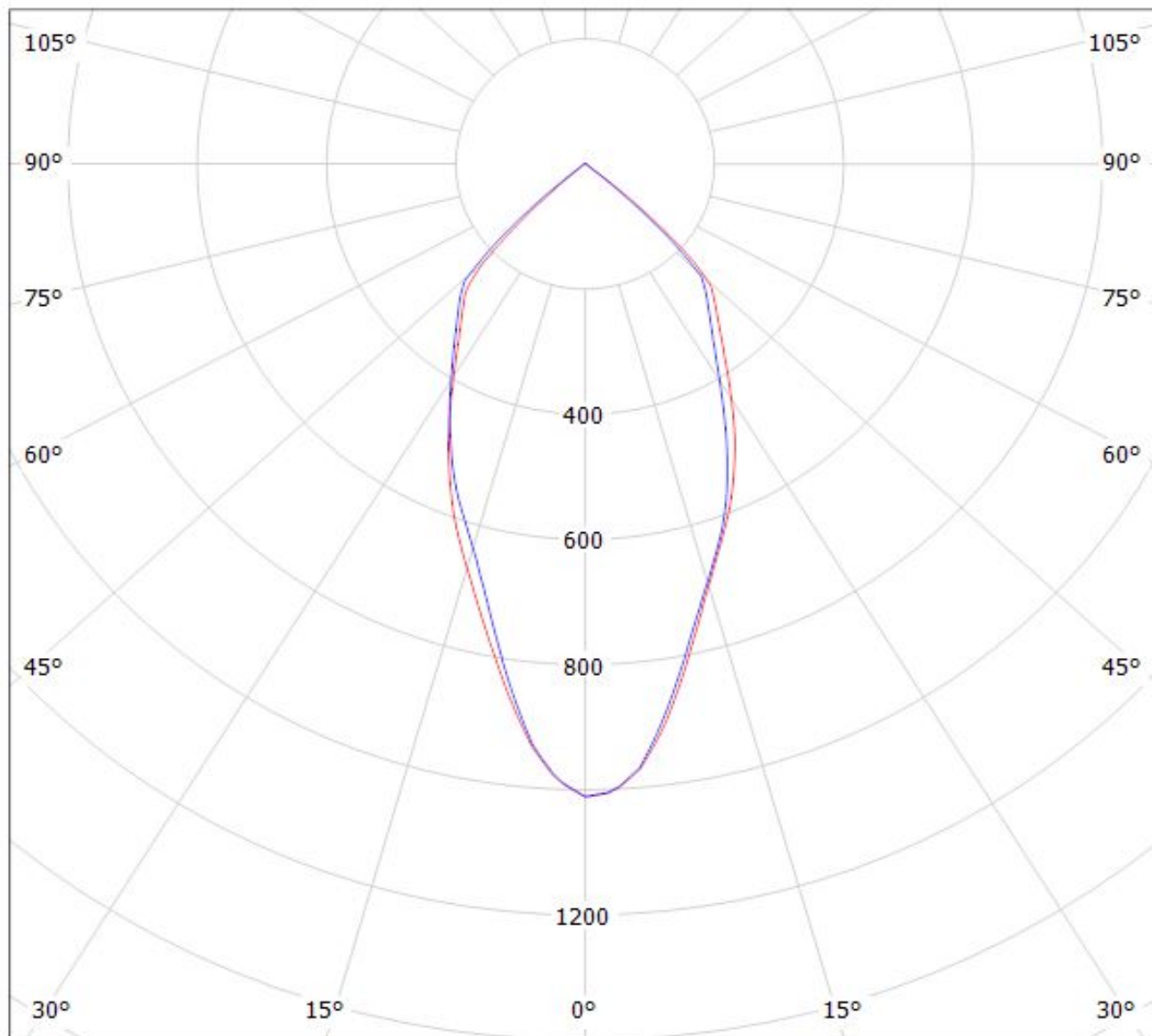

cd/klm

$\eta = 94\%$

— C0 - C180

— C90 - C270

Luminaire: LEDiL Oy F13402_ANGELINA-W_(CXA30) Eff. 93%

Lamps: 1 x CREE_CXA30_(CXA3050-3C0-Y2-N0H)_1340.66lm@250mA_P=8.16471W_CCT=5000K_I=249.8mA

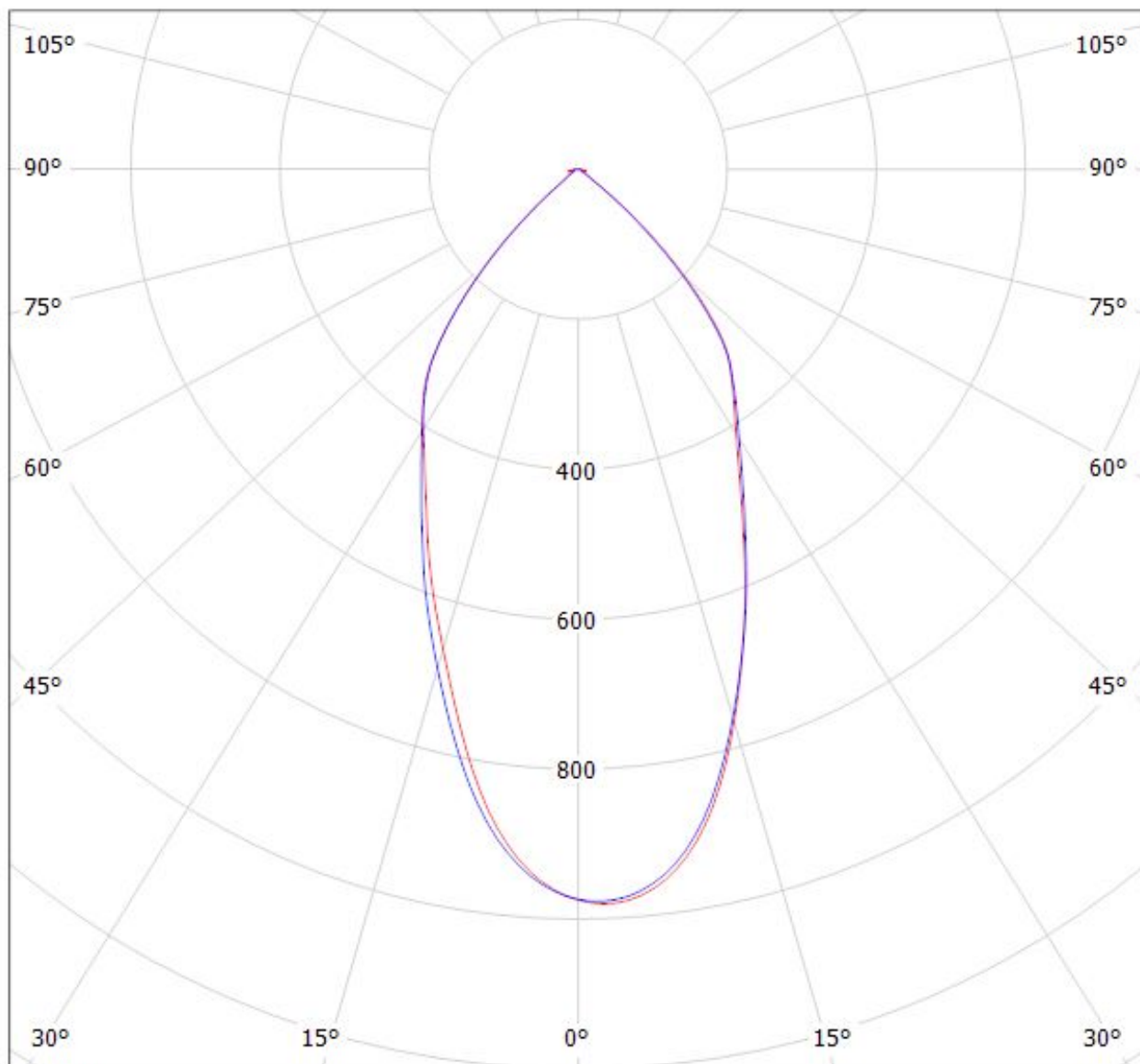

cd/klm

— C0 - C180

— C90 - C270

$\eta = 93\%$

Luminaire: LEDiL Oy F13402_ANGELINA-W_(STARK_SLE_G2_LES23) Eff.90.2%

Lamps: 1 x TRIDONIC STARK SLE G2 LES23 830 CLA 982.73lm@250mA CCT=3000K P=8W I=250mA

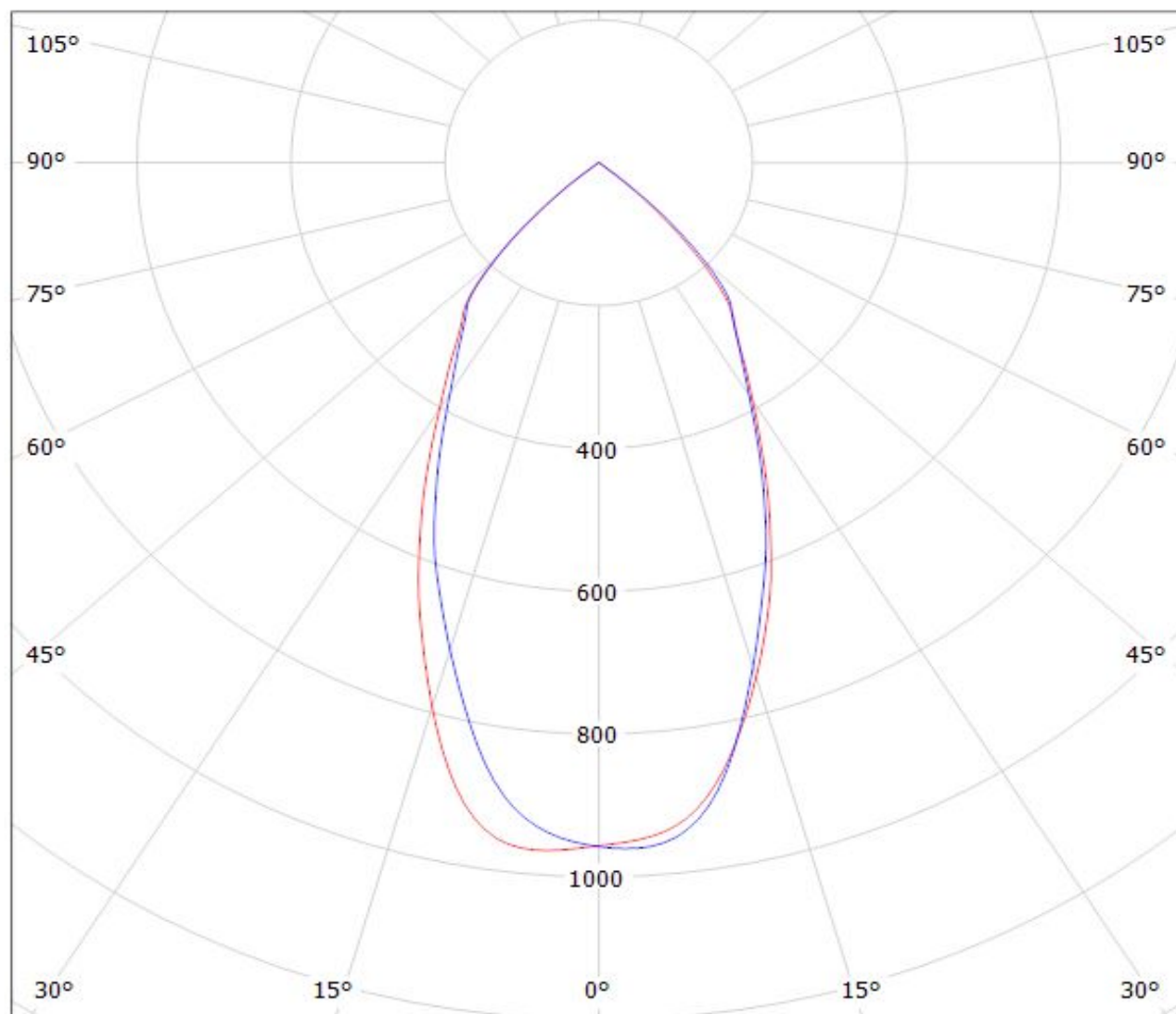

cd/klm

— C0 - C180

— C90 - C270

$\eta = 90\%$

Luminaire: LEDiL Oy F13402_ANGELINA-W_(FORTIMO_4500) Eff.89.0%
Lamps: 1 x PHILIPS Fortimo 4500

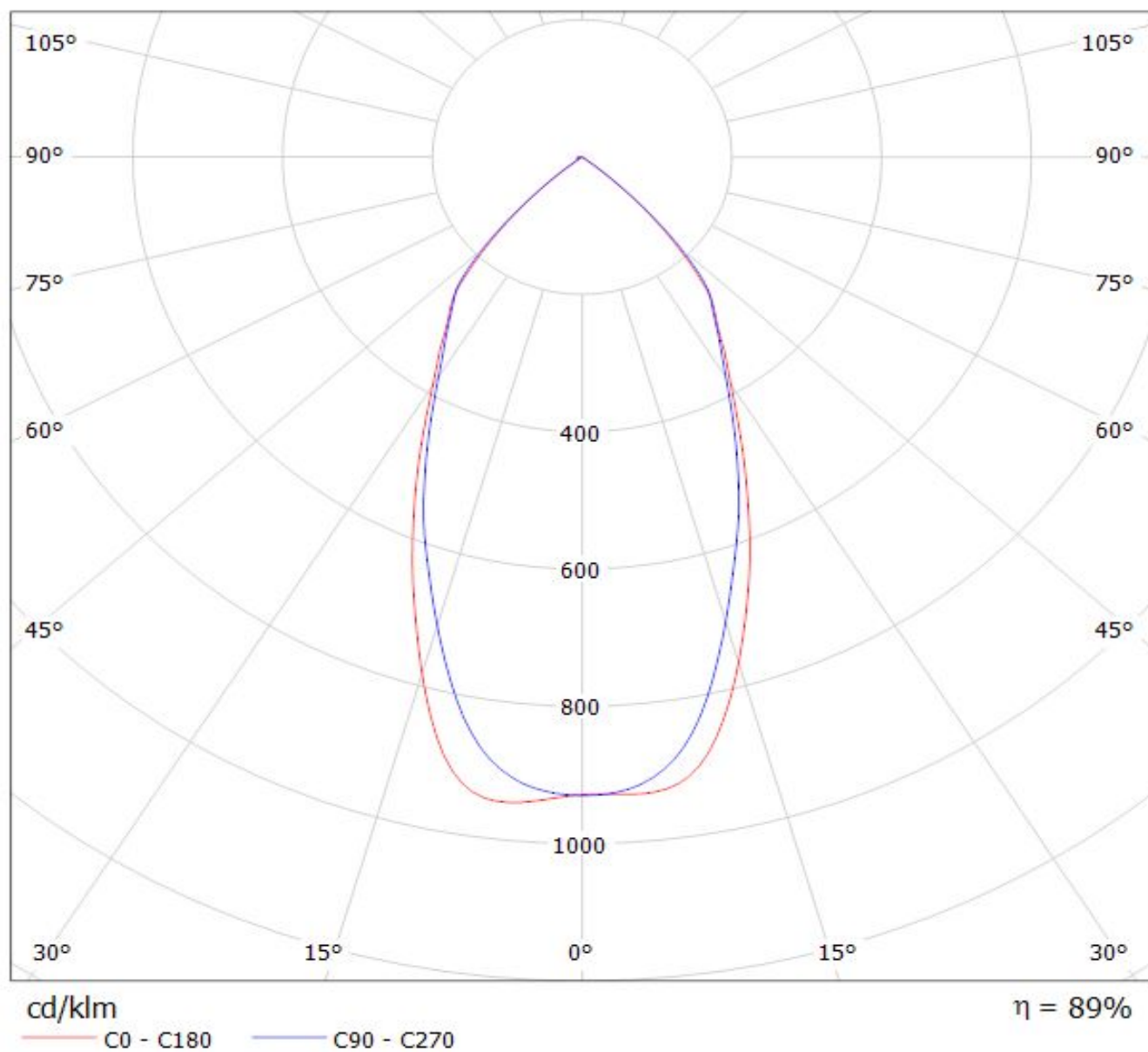

Luminaire: LEDiL Oy F13402_ANGELINA-W_(STARK_SLE_G2_LES26) Eff.89.0%

Lamps: 1 x TRIDONIC STARK SLE G2 LES26 830 CLA 1095.88lm@250mA CCT=3000K P=8W I=250mA

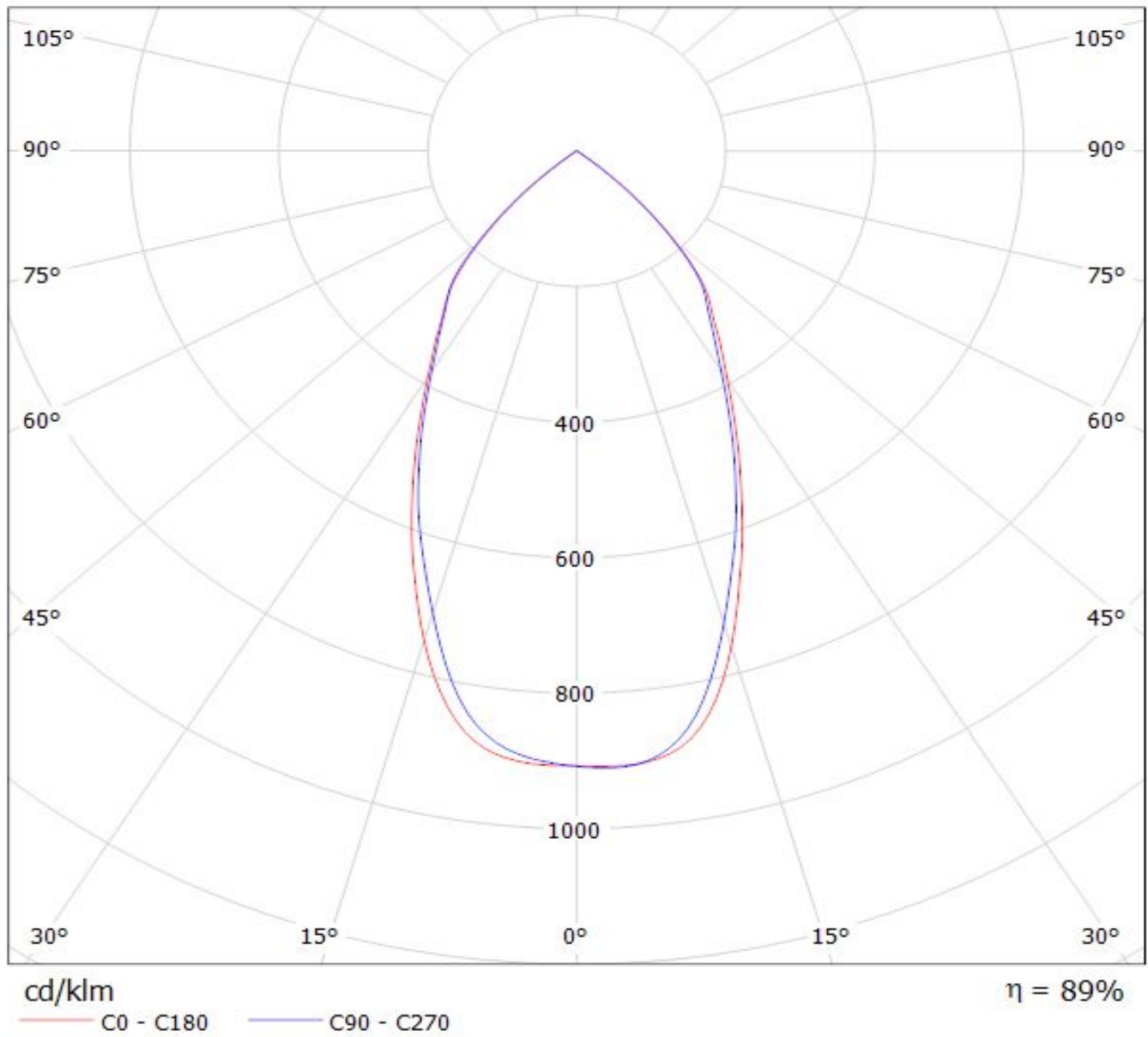

Luminaire: LEDiL Oy F13402_ANGELINA-W_(PrevaLED_LES23) Eff. 94%

Lamps: 1 x OSRAM PrevaLED_LES23_(PL-CORE-5000-930-Z3)_1102.2lm@250mA_P=9.93654W_I=249.8mA

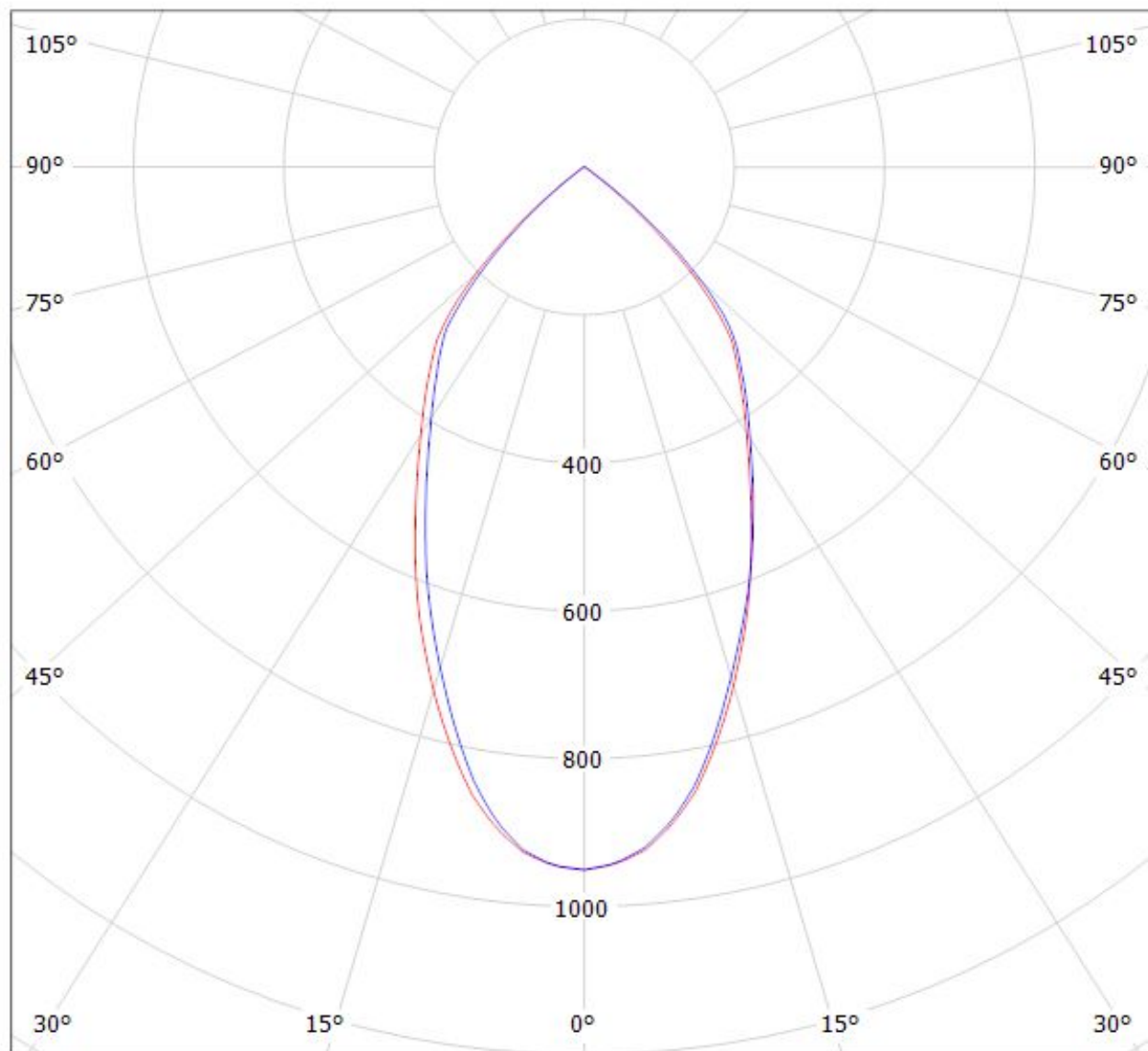

cd/klm

$\eta = 94\%$

— C0 - C180 — C90 - C270

Luminaire: LEDiL Oy F13402_ANGELINA-W_(WU-M-462-827)

Lamps: 1 x Vossloh_WU-M-462-827_1116.7lm@250mA_P=8.9943W_I=249.8mA

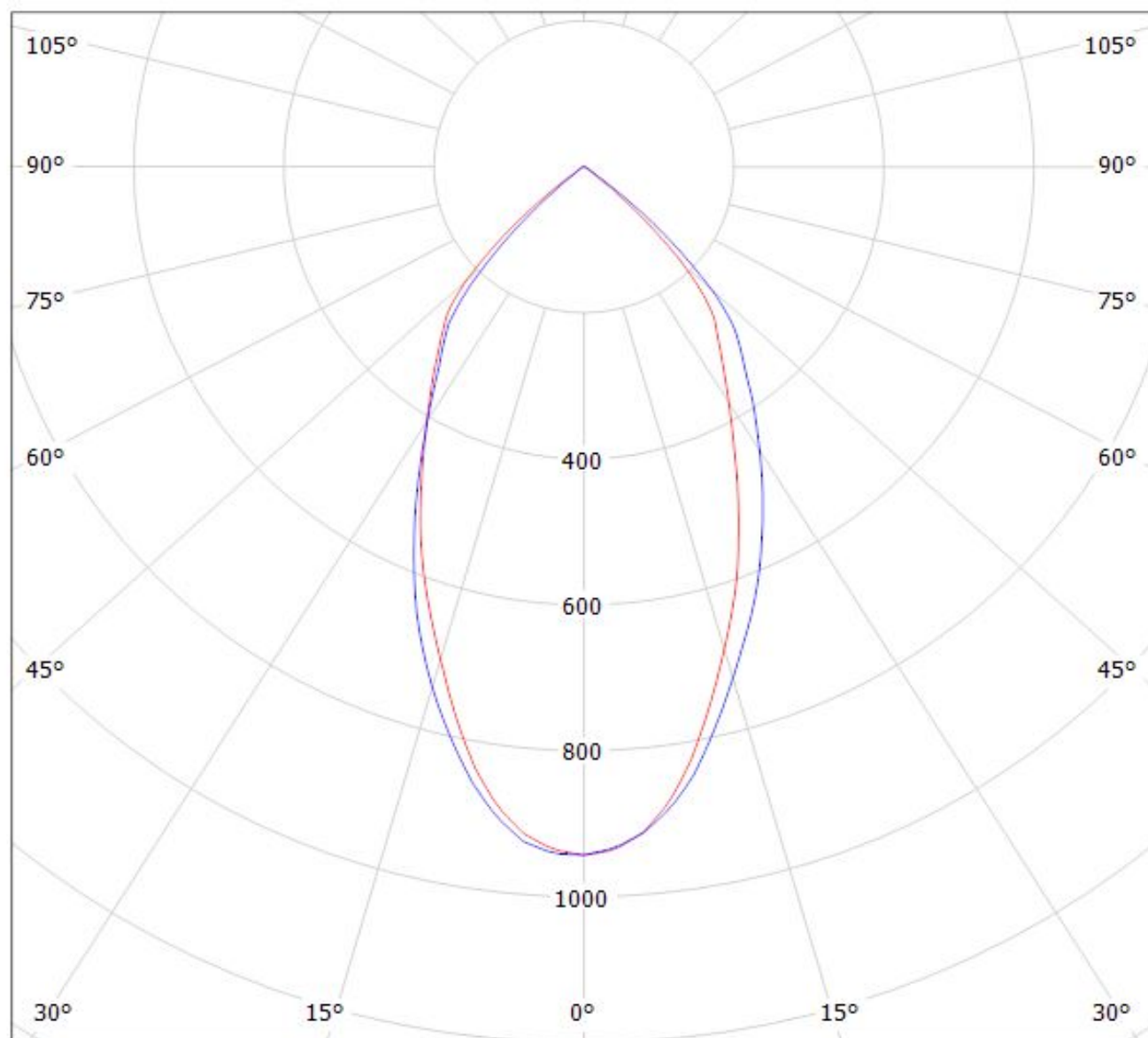

cd/klm

— C0 - C180

— C90 - C270

$\eta = 93\%$

Luminaire: LEDiL Oy F13402_ANGELINA-W_(WU-M-464-827)

Lamps: 1 x Vossloh_WU-M-464-827_1452.93lm@250mA_P=11.6939W_I=249.8mA

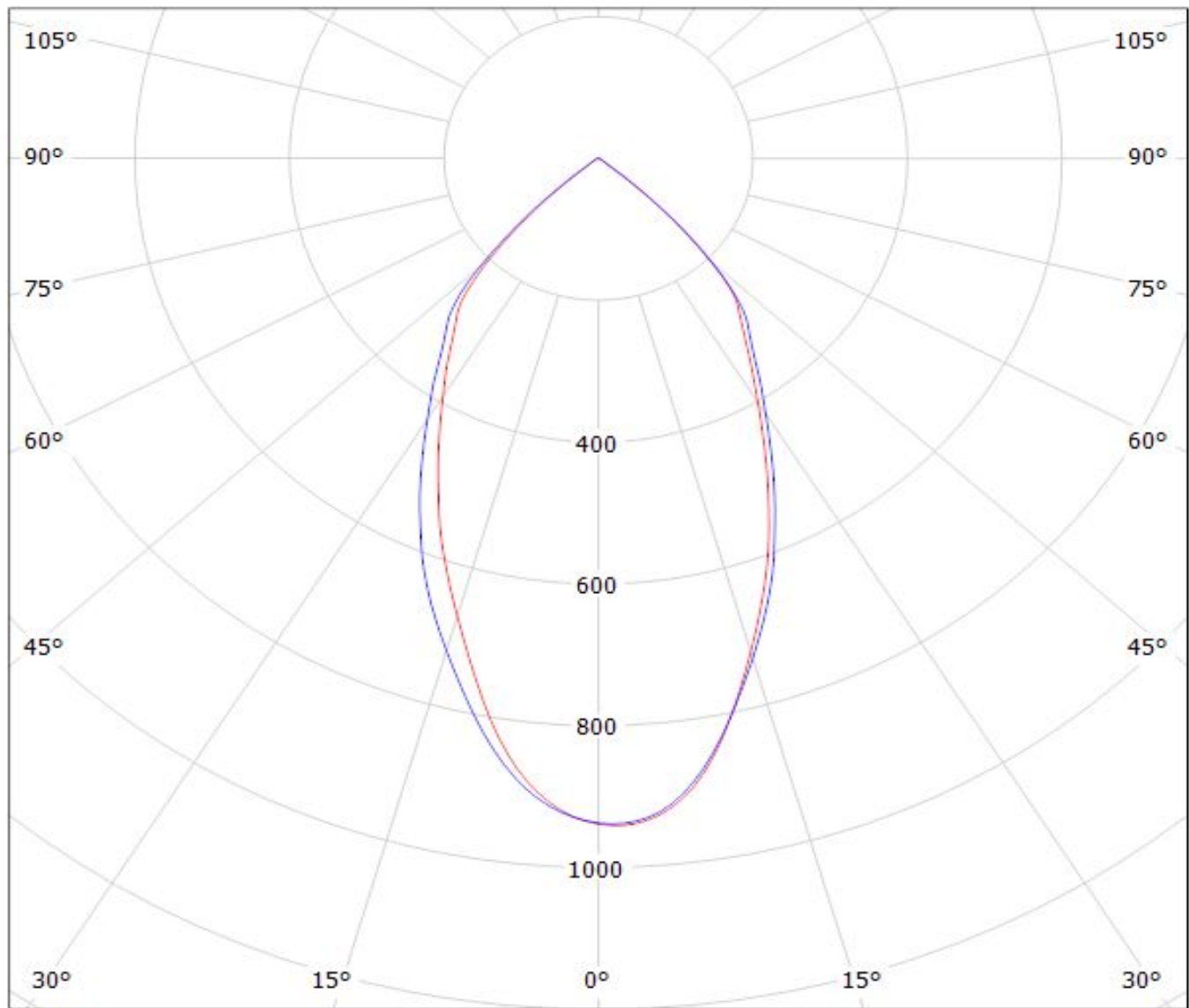

cd/klm

— C0 - C180 — C90 - C270

$\eta = 93\%$

Luminaire: LEDiL Oy F13402_ANGELINA-W_(WU-M-486) Eff.92.5%
Lamps: 1 x Vossloh_Schwabe-WU-M-486_(WU-M-486-830)
_1474.55lm@250mA_P=10.4456W_I=249.8mA

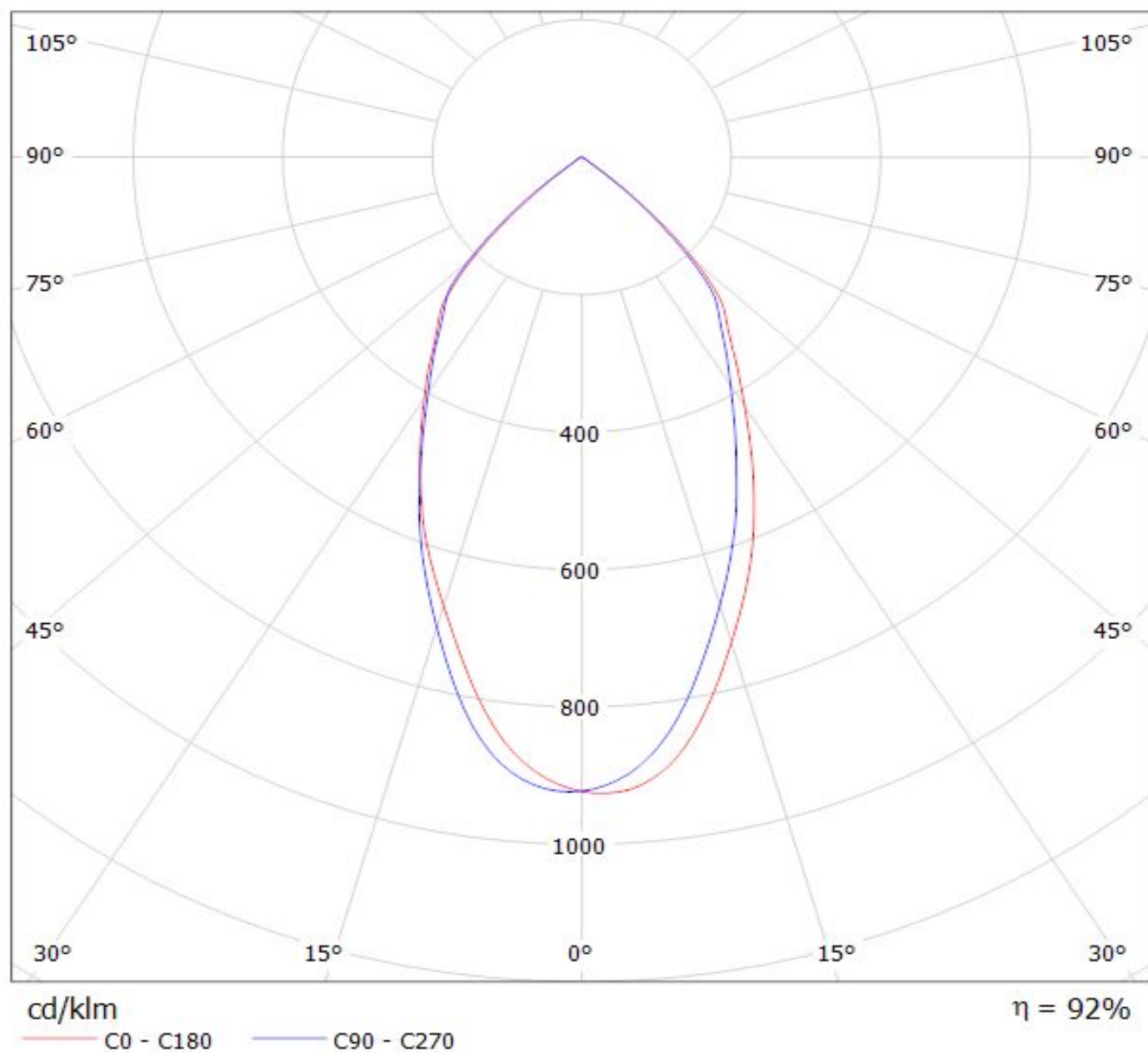

Luminaire: LEDiL Oy F13402_ANGELINA-W_(SLE_G3_LES23) Eff.90.3%

Lamps: 1 x TRIDONIC_STARK_SLE_G3_LES23_(STARK-SLE-PURE_G3-23-3000-930-SEL)_813.196lm@250mA_CCT=3000K_P=8.20018W_I=249.8mA

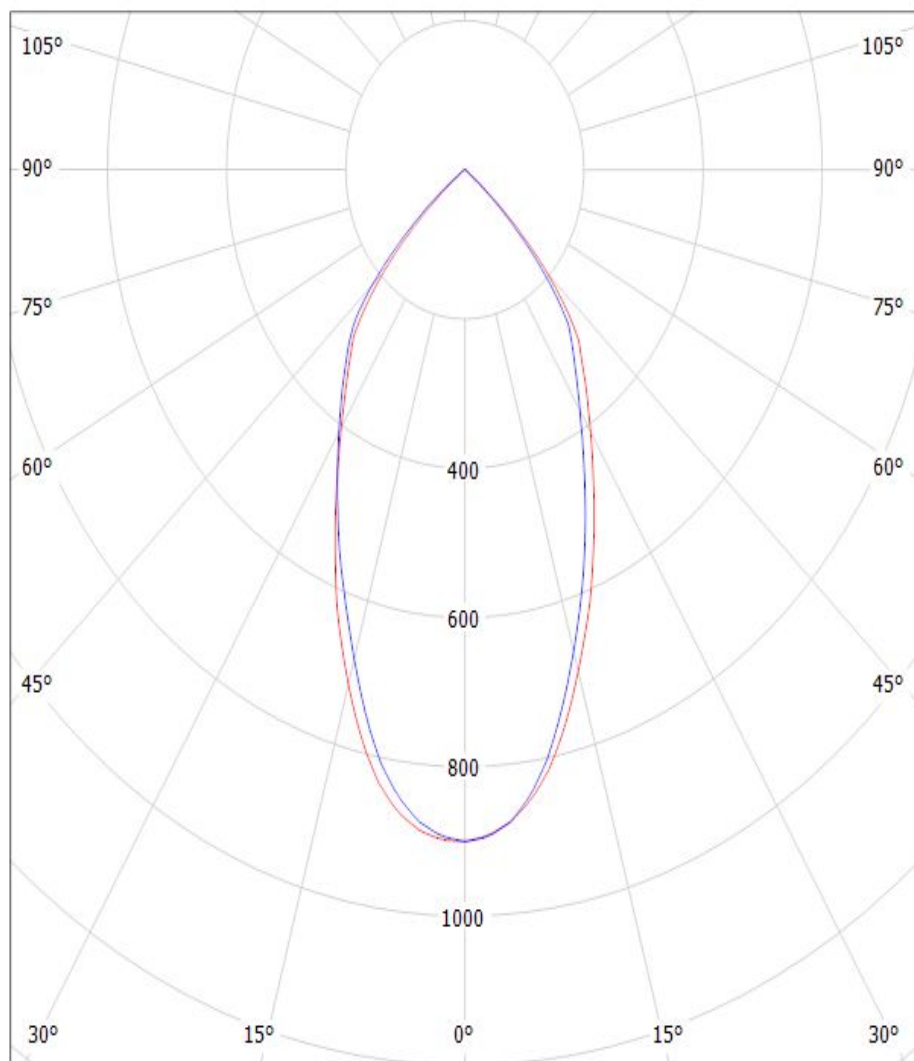

cd/klm

— C0 - C180 — C90 - C270

$\eta = 90\%$

Luminaire: LEDiL Oy F13402_ANGELINA-W_(WU-M-484)

Lamps: 1 x Vossloh_Schwabe-WU-M-485_(WU-M-485-830)_1209.62lm@250mA_P=8.43849W_I=249.8mA

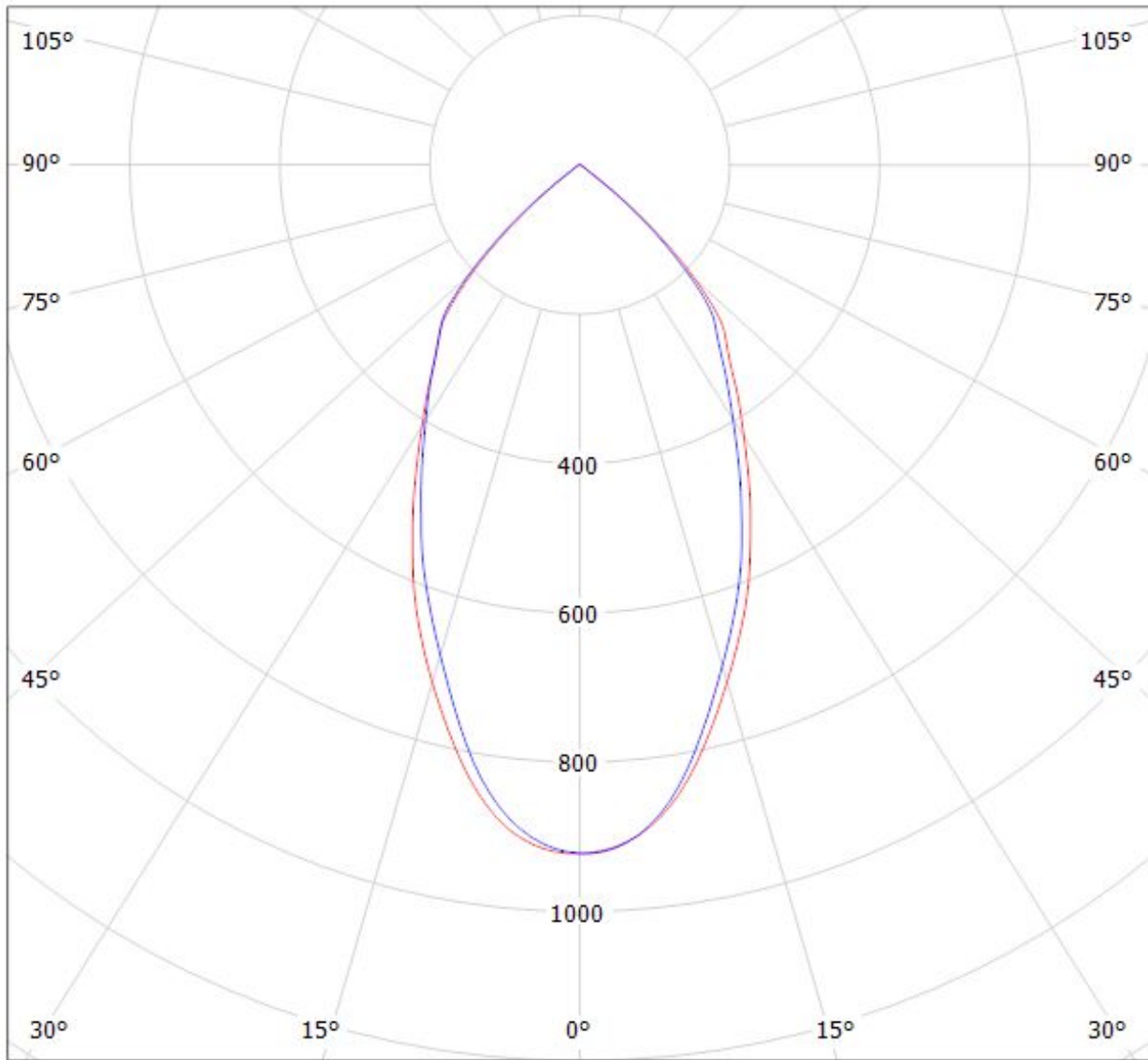

cd/klm

— C0 - C180 — C90 - C270

$\eta = 93\%$

NOTE: The typical divergence will be changed by different color, chip size and chip position tolerance. The typical total divergence is the full angle measured where the luminous intensity is half of the peak value.

GENERAL INFORMATION

- Product series especially designed & optimized for series of LEDs.
- Special care taken to make light distribution as uniform as possible.
- Reflector is made of aluminium coated PC (120 degrees of Celcius / 248 degrees of Fahrenheit) with protective lacquer (short term 100 degrees of Celcius / 212 degrees of Fahrenheit).

Note! Due to use of high power COB's with this product, special attention to proper thermal design is highly recommended. LEDiL has no liability for direct, indirect or consecutive damages arising from the LEDiL products being used outside of the recommended temperature range.