

**Sec: A - A**

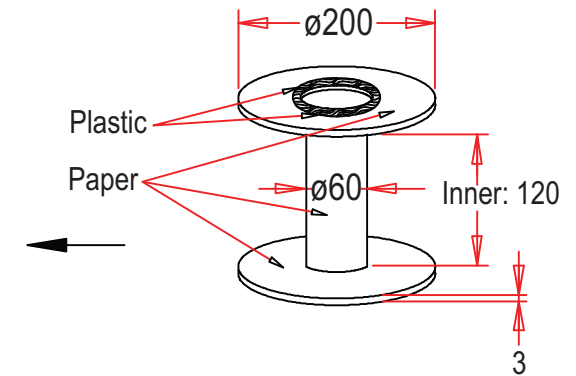

**500Ft/R. "PE" Foam Wrapped**

Unit: MM

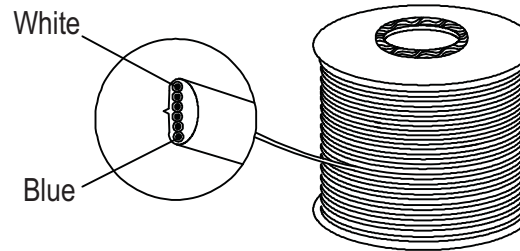

ITEM NO.  
**AT-K-26-6-W/500-R**  
 TITLE  
 Modular Straight cable - Raw, 6 Contact, 26AWG,  
 White, 500Ft

**ASSMANN**  
 Electronics, Inc.

1840 W. Drake Drive, Suite 101 • Tempe, AZ 85283  
 Toll Free: 1-877-277-6266 • Email: info@usa-assmann.com

THIS DRAWING IS UNPUBLISHED  
 ©Copyright 2011 by Assmann Electronic Components  
 All International Rights Reserved