

Features

- Pop and click noise protection circuitry
- Operating range from $V_{CC} = 2.2\text{ V}$ to 5.5 V
- Standby mode active low (TS488) or high (TS489)
- Output power:
 - 120 mW at 5 V, into $16\ \Omega$ with 0.1% THD+N max (1 kHz)
 - 55 mW at 3.3 V, into $16\ \Omega$ with 0.1% THD+N max (1 kHz)
- Low current consumption: 2.7 mA max at 5 V
- Ultra-low standby current consumption: 10 nA typical
- High signal-to-noise ratio
- High crosstalk immunity: 102 dB ($F = 1\text{ kHz}$)
- PSRR: 70 dB typ. ($F = 1\text{ kHz}$), inputs grounded at 5 V
- Unity-gain stable
- Short-circuit protection circuitry
- Available in lead-free MiniSO-8 & DFN8
2 mm x 2 mm

Description

The TS488/9 is an enhancement of TS486/7 that eliminates pop and click noise and reduces the number of external passive components.

The TS488/9 is a dual audio power amplifier capable of driving, in single-ended mode, either a $16\ \Omega$ or a $32\ \Omega$ stereo headset.

Capable of descending to low voltages, it delivers up to 31 mW per channel (into $16\ \Omega$ loads) of continuous average power with 0.1% THD+N in the audio bandwidth from a 2.5 V power supply.

An externally-controlled standby mode reduces the supply current to 10 nA (typ.). The unity gain stable TS488/9 is configured by external gain-setting resistors.

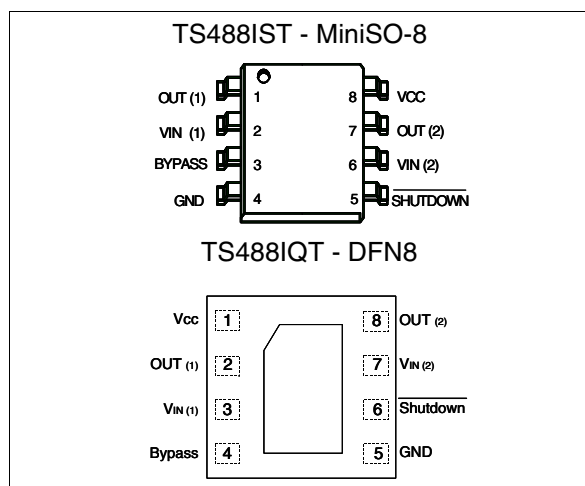

Applications

- Headphone amplifiers
- Mobile phones, PDAs, computer motherboards
- High-end TVs, portable audio players

Contents

| | | |
|----------|--|-----------|
| 1 | Typical application schematic | 3 |
| 2 | Absolute maximum ratings and operating conditions | 4 |
| 3 | Electrical characteristics | 5 |
| 4 | Application information | 22 |
| 4.1 | Power dissipation and efficiency | 22 |
| 4.2 | Total power dissipation | 23 |
| 4.3 | Lower cutoff frequency | 23 |
| 4.4 | Higher cutoff frequency | 24 |
| 4.5 | Gain setting | 25 |
| 4.6 | Decoupling of the circuit | 25 |
| 4.7 | Standby mode | 25 |
| 4.8 | Wake-up time | 26 |
| 4.9 | POP performance | 26 |
| | Connecting the headphones | 27 |
| 5 | Package mechanical data | 28 |
| 5.1 | MiniSO-8 package | 28 |
| 5.2 | DFN8 package | 29 |
| 6 | Ordering information | 30 |
| 7 | Revision history | 31 |

1 Typical application schematic

Figure 1. Typical application for the TS488-TS489

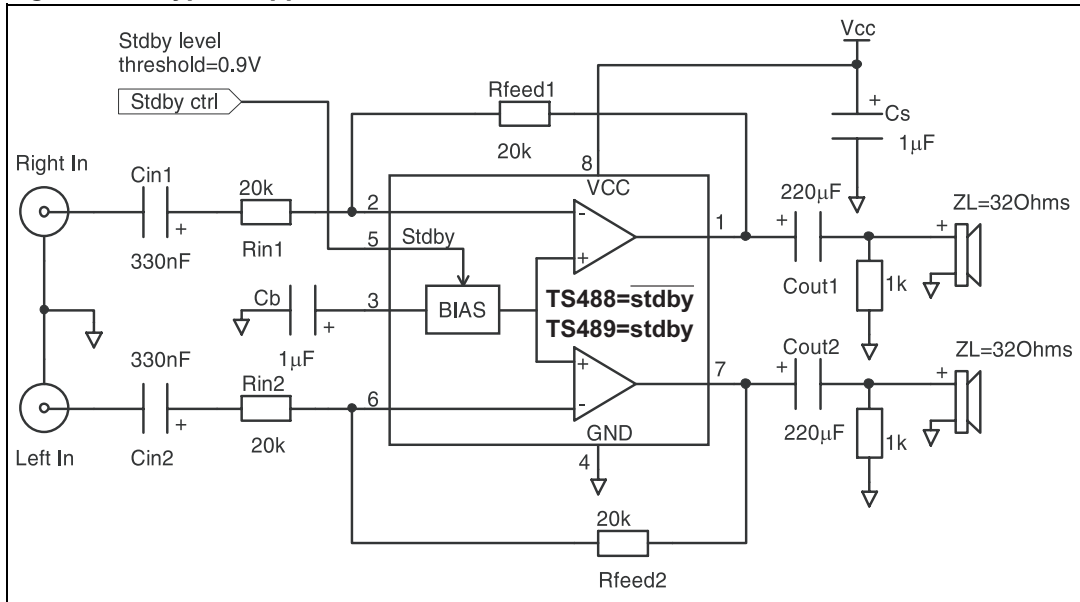

Table 1. Application component information

| Component | Functional description |
|---------------|--|
| $R_{in1,2}$ | Inverting input resistor that sets the closed loop gain in conjunction with R_{feed} . This resistor also forms a high pass filter with C_{in} ($F_c = 1 / (2 \times \text{Pi} \times R_{in} \times C_{in})$). |
| $C_{in1,2}$ | Input coupling capacitor that blocks the DC voltage at the amplifier's input terminal. |
| $R_{feed1,2}$ | Feedback resistor that sets the closed loop gain in conjunction with R_{in} . $A_V = \text{Closed Loop Gain} = -R_{feed}/R_{in}$. |
| C_s | Supply output capacitor that provides power supply filtering. |
| C_b | Bypass capacitor that provides half supply filtering. |
| $C_{out1,2}$ | Output coupling capacitor that blocks the DC voltage at the load input terminal. This capacitor also forms a high pass with R_L ($F_c = 1 / (2 \times \text{Pi} \times R_L \times C_{out})$). |

2 Absolute maximum ratings and operating conditions

Table 2. Absolute maximum ratings

| Symbol | Parameter | Value | Unit |
|------------|--|----------------------------|------|
| V_{CC} | Supply voltage ⁽¹⁾ | 6 | V |
| V_i | Input voltage | -0.3 V to $V_{CC} + 0.3$ V | V |
| T_{stg} | Storage temperature | -65 to +150 | °C |
| T_j | Maximum junction temperature | 150 | °C |
| R_{thja} | Thermal resistance junction-to-ambient MiniSO-8 DFN8 | 215 70 | °C/W |
| P_{diss} | Power dissipation ⁽²⁾ : MiniSO-8 DFN8 | 0.58 1.79 | W |
| ESD | Human body model (pin to pin) | 2 | kV |
| ESD | Machine model 220 pF - 240 pF (pin to pin) | 200 | V |
| Latch-up | Latch-up immunity (all pins) | 200 | mA |
| | Lead temperature (soldering, 10 sec) | 250 | °C |
| | Output short-circuit to V_{CC} or GND | continuous ⁽³⁾ | |

1. All voltage values are measured with respect to the ground pin.
2. P_{diss} is calculated with $T_{amb} = 25$ °C, $T_j = 150$ °C.
3. Attention must be paid to continuous power dissipation ($V_{DD} \times 250$ mA). Short-circuits can cause excessive heating and destructive dissipation. Exposing the IC to a short-circuit for an extended period of time will dramatically reduce the product's life expectancy.

Table 3. Operating conditions

| Symbol | Parameter | Value | Unit |
|------------|--|---|----------|
| V_{CC} | Supply voltage | 2.2 to 5.5 | V |
| R_L | Load resistor | ≥ 16 | Ω |
| T_{oper} | Operating free air temperature range | -40 to + 85 | °C |
| C_L | Load capacitor: $R_L = 16$ to 100Ω $R_L > 100 \Omega$ | 400 100 | pF |
| V_{STBY} | Standby voltage input: TS488 active, TS489 in standby TS488 in standby, TS489 active | $1.5 \leq V \leq V_{CC}$ $GND \leq V_{STBY} \leq 0.4$ ⁽¹⁾ | V |
| R_{thja} | Thermal resistance junction-to-ambient MiniSO-8 DFN8 ⁽²⁾ | 190 40 | °C/W |

1. The minimum current consumption (I_{STBY}) is guaranteed at GND (TS488) or V_{CC} (TS489) for the whole temperature range.
2. When mounted on a 4-layer PCB.

3 Electrical characteristics

**Table 4. Electrical characteristics at $V_{CC} = +5\text{ V}$
with $GND = 0\text{ V}$, $T_{amb} = 25\text{ °C}$ (unless otherwise specified)**

| Symbol | Parameter | Conditions | Min. | Typ. | Max. | Unit |
|------------|---|---|------|-------------|------|------------------|
| I_{CC} | Supply current | No input signal, no load | | 2 | 2.7 | mA |
| I_{STBY} | Standby current | No input signal, $V_{STBY} = GND$ for TS488, $R_L = 32\ \Omega$ | | 10 | 1000 | nA |
| | | No input signal, $V_{STBY} = V_{CC}$ for TS489, $R_L = 32\ \Omega$ | | 10 | 1000 | |
| P_{out} | Output power | THD+N = 0.1% max, $F = 1\text{ kHz}$, $R_L = 32\ \Omega$ | | 75 | | mW |
| | | THD+N = 1% max, $F = 1\text{ kHz}$, $R_L = 32\ \Omega$ | 70 | 80 | | |
| | | THD+N = 0.1% max, $F = 1\text{ kHz}$, $R_L = 16\ \Omega$ | | 120 | | |
| | | THD+N = 1% max, $F = 1\text{ kHz}$, $R_L = 16\ \Omega$ | 100 | 130 | | |
| THD+N | Total harmonic distortion + noise | $A_V = -1$, $R_L = 32\ \Omega$, $P_{out} = 60\text{ mW}$, $20\text{ Hz} \leq F \leq 20\text{ kHz}$ | | 0.3 | | % |
| | | $A_V = -1$, $R_L = 16\ \Omega$, $P_{out} = 90\text{ mW}$, $20\text{ Hz} \leq F \leq 20\text{ kHz}$ | | 0.3 | | |
| PSRR | Power supply rejection ratio, inputs grounded ⁽¹⁾ | $A_V = -1$, $R_L \geq 16\ \Omega$, $C_b = 1\ \mu\text{F}$, $F = 1\text{ kHz}$, $V_{ripple} = 200\text{ mVpp}$ | 64 | 70 | | dB |
| | | $A_V = -1$, $R_L \geq 16\ \Omega$, $C_b = 1\ \mu\text{F}$, $F = 217\text{ Hz}$, $V_{ripple} = 200\text{ mVpp}$ | 62 | 68 | | |
| V_O | Output swing | V_{OL} : $R_L = 32\ \Omega$ | | 0.23 | 0.31 | V |
| | | V_{OH} : $R_L = 32\ \Omega$ | 4.53 | 4.72 | | |
| | | V_{OL} : $R_L = 16\ \Omega$ | | 0.44 | 0.57 | |
| | | V_{OH} : $R_L = 16\ \Omega$ | 4.18 | 4.48 | | |
| SNR | Signal-to-noise ratio | A-weighted, $A_V = -1$, $R_L = 32\ \Omega$, THD+N < 0.4%, $20\text{ Hz} \leq F \leq 20\text{ kHz}$ | | 105 | | dB |
| Crosstalk | Channel separation | $R_L = 32\ \Omega$, $A_V = -1$ $F = 1\text{ kHz}$ $F = 20\text{ Hz to } 20\text{ kHz}$ | | -102 -84 | | dB |
| C_i | Input capacitance | | | 1 | | pF |
| GBP | Gain bandwidth product | $R_L = 32\ \Omega$ | | 1.1 | | MHz |
| SR | Slew rate, unity gain inverting | $R_L = 16\ \Omega$ | | 0.65 | | V/ μs |
| V_{IO} | Input offset voltage | $V_{icm} = V_{CC}/2$ | | 1 | 20 | mV |
| t_{wu} | Wake-up time | | | 100 | | ms |

1. Guaranteed by design and evaluation.

Table 5. Electrical characteristics at $V_{CC} = +3.3\text{ V}$ with $GND = 0\text{ V}$, $T_{amb} = 25\text{ °C}$ (unless otherwise specified) ⁽¹⁾

| Symbol | Parameter | Conditions | Min. | Typ. | Max. | Unit |
|------------|--|--|------|-------------|------|------------------|
| I_{CC} | Supply current | No input signal, no load | | 1.8 | 2.5 | mA |
| I_{STBY} | Standby current | No input signal, $V_{STBY} = GND$ for TS488, $R_L = 32\ \Omega$ | | 10 | 1000 | nA |
| | | No input signal, $V_{STBY} = V_{CC}$ for TS489, $R_L = 32\ \Omega$ | | 10 | 1000 | |
| P_{out} | Output power | THD+N = 0.1% max, $F = 1\text{ kHz}$, $R_L = 32\ \Omega$ | | 34 | | mW |
| | | THD+N = 1% max, $F = 1\text{ kHz}$, $R_L = 32\ \Omega$ | 30 | 35 | | |
| | | THD+N = 0.1% max, $F = 1\text{ kHz}$, $R_L = 16\ \Omega$ | | 55 | | |
| | | THD+N = 1% max, $F = 1\text{ kHz}$, $R_L = 16\ \Omega$ | 47 | 57 | | |
| THD+N | Total harmonic distortion + noise | $A_V = -1$, $R_L = 32\ \Omega$, $P_{out} = 16\text{ mW}$, $20\text{ Hz} \leq F \leq 20\text{ kHz}$ | | 0.3 | | % |
| | | $A_V = -1$, $R_L = 16\ \Omega$, $P_{out} = 35\text{ mW}$, $20\text{ Hz} \leq F \leq 20\text{ kHz}$ | | 0.3 | | |
| PSRR | Power supply rejection ratio, inputs grounded ⁽²⁾ | $A_V = -1$, $R_L \geq 16\ \Omega$, $C_b = 1\ \mu\text{F}$, $F = 1\text{ kHz}$, $V_{ripple} = 200\text{ mVpp}$ | 63 | 69 | | dB |
| | | $A_V = -1$, $R_L \geq 16\ \Omega$, $C_b = 1\ \mu\text{F}$, $F = 217\text{ Hz}$, $V_{ripple} = 200\text{ mVpp}$ | 61 | 67 | | |
| V_O | Output swing | V_{OL} : $R_L = 32\ \Omega$ | | 0.15 | 0.2 | V |
| | | V_{OH} : $R_L = 32\ \Omega$ | 3.03 | 3.12 | | |
| | | V_{OL} : $R_L = 16\ \Omega$ | | 0.28 | 0.36 | |
| | | V_{OH} : $R_L = 16\ \Omega$ | 2.82 | 2.97 | | |
| SNR | Signal-to-noise ratio | A-weighted, $A_V = -1$, $R_L = 32\ \Omega$, THD+N < 0.4%, $20\text{ Hz} \leq F \leq 20\text{ kHz}$ | | 102 | | dB |
| Crosstalk | Channel separation | $R_L = 32\ \Omega$, $A_V = -1$ $F = 1\text{ kHz}$ $F = 20\text{ Hz to } 20\text{ kHz}$ | | -102 -84 | | dB |
| C_i | Input capacitance | | | 1 | | pF |
| GBP | Gain bandwidth product | $R_L = 32\ \Omega$ | | 1.1 | | MHz |
| SR | Slew rate, unity gain inverting | $R_L = 16\ \Omega$ | | 0.6 | | V/ μs |
| V_{IO} | Input offset voltage | $V_{icm} = V_{CC}/2$ | | 1 | 20 | mV |
| t_{wu} | Wake-up time | | | 100 | | ms |

1. All electrical values are guaranteed with correlation measurements at 2.5 V and 5 V.
2. Guaranteed by design and evaluation.

**Table 6. Electrical characteristics at $V_{CC} = +2.5\text{ V}$
with $GND = 0\text{ V}$, $T_{amb} = 25\text{ °C}$ (unless otherwise specified)**

| Symbol | Parameter | Conditions | Min. | Typ. | Max. | Unit |
|------------|---|---|------|-------------|------|------------------|
| I_{CC} | Supply current | No input signal, no load | | 1.8 | 2.5 | mA |
| I_{STBY} | Standby current | No input signal, $V_{STBY} = GND$ for TS488, $R_L = 32\ \Omega$ | | 10 | 1000 | nA |
| | | No input signal, $V_{STBY} = V_{CC}$ for TS489, $R_L = 32\ \Omega$ | | 10 | 1000 | |
| P_{out} | Output power | THD+N = 0.1% max, $F = 1\text{ kHz}$, $R_L = 32\ \Omega$ | | 19 | | mW |
| | | THD+N = 1% max, $F = 1\text{ kHz}$, $R_L = 32\ \Omega$ | 18 | 20 | | |
| | | THD+N = 0.1% max, $F = 1\text{ kHz}$, $R_L = 16\ \Omega$ | | 31 | | |
| | | THD+N = 1% max, $F = 1\text{ kHz}$, $R_L = 16\ \Omega$ | 27 | 32 | | |
| THD+N | Total harmonic distortion + noise | $A_V = -1$, $R_L = 32\ \Omega$, $P_{out} = 10\text{ mW}$, $20\text{ Hz} \leq F \leq 20\text{ kHz}$ | | 0.3 | | % |
| | | $A_V = -1$, $R_L = 16\ \Omega$, $P_{out} = 16\text{ mW}$, $20\text{ Hz} \leq F \leq 20\text{ kHz}$ | | 0.3 | | |
| PSRR | Power supply rejection ratio, inputs grounded ⁽¹⁾ | $A_V = -1$, $R_L \geq 16\ \Omega$, $C_b = 1\ \mu\text{F}$, $F = 1\text{ kHz}$, $V_{ripple} = 200\text{ mVpp}$ | | 68 | | dB |
| | | $A_V = -1$, $R_L \geq 16\ \Omega$, $C_b = 1\ \mu\text{F}$, $F = 217\text{ Hz}$, $V_{ripple} = 200\text{ mVpp}$ | | 66 | | |
| V_O | Output swing | V_{OL} : $R_L = 32\ \Omega$ | | 0.12 | 0.16 | V |
| | | V_{OH} : $R_L = 32\ \Omega$ | 2.3 | 2.36 | | |
| | | V_{OL} : $R_L = 16\ \Omega$ | | 0.22 | 0.28 | |
| | | V_{OH} : $R_L = 16\ \Omega$ | 2.15 | 2.25 | | |
| SNR | Signal-to-noise ratio | A-weighted, $A_V = -1$, $R_L = 32\ \Omega$, THD+N < 0.4%, $20\text{ Hz} \leq F \leq 20\text{ kHz}$ | | 100 | | dB |
| Crosstalk | Channel separation | $R_L = 32\ \Omega$, $A_V = -1$ $F = 1\text{ kHz}$ $F = 20\text{ Hz to } 20\text{ kHz}$ | | -102 -84 | | dB |
| C_i | Input capacitance | | | 1 | | pF |
| GBP | Gain bandwidth product | $R_L = 32\ \Omega$ | | 1.1 | | MHz |
| SR | Slew rate, unity gain inverting | $R_L = 16\ \Omega$ | | 0.6 | | V/ μs |
| V_{IO} | Input offset voltage | $V_{icm} = V_{CC}/2$ | | 1 | 20 | mV |
| t_{wu} | Wake-up time | | | 100 | | ms |

1. Guaranteed by design and evaluation.

Table 7. Index of graphics

| Description | Figure |
|--|-------------------------------|
| <i>Open-loop frequency response</i> | <i>Figure 2 to Figure 11</i> |
| <i>Power derating curves</i> | <i>Figure 12 to Figure 13</i> |
| <i>Signal-to-noise ratio vs. power supply voltage</i> | <i>Figure 14 to Figure 19</i> |
| <i>Power dissipation vs. output power per channel</i> | <i>Figure 20 to Figure 22</i> |
| <i>Power supply rejection ratio vs. frequency</i> | <i>Figure 23 to Figure 25</i> |
| <i>Total harmonic distortion plus noise vs. output power</i> | <i>Figure 26 to Figure 43</i> |
| <i>Total harmonic distortion plus noise vs. frequency</i> | <i>Figure 44 to Figure 52</i> |
| <i>Output power vs. load resistance</i> | <i>Figure 53 to Figure 55</i> |
| <i>Output power vs. power supply voltage</i> | <i>Figure 56, Figure 57</i> |
| <i>Output voltage swing vs. power supply voltage</i> | <i>Figure 58</i> |
| <i>Current consumption vs. power supply voltage</i> | <i>Figure 59</i> |
| <i>Current consumption vs. standby voltage</i> | <i>Figure 60 to Figure 65</i> |
| <i>Crosstalk vs. frequency</i> | <i>Figure 66 to Figure 77</i> |

Figure 2. Open-loop frequency response

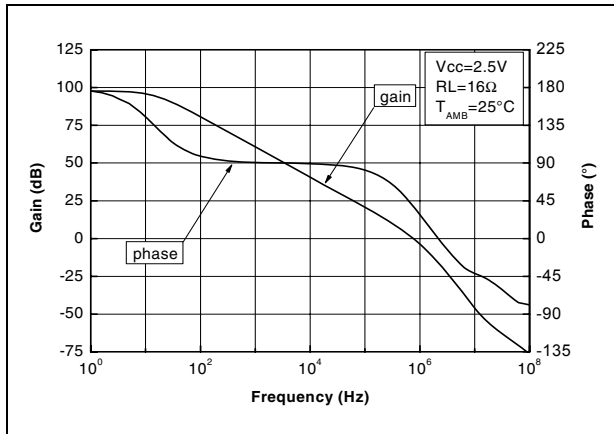

Figure 3. Open-loop frequency response

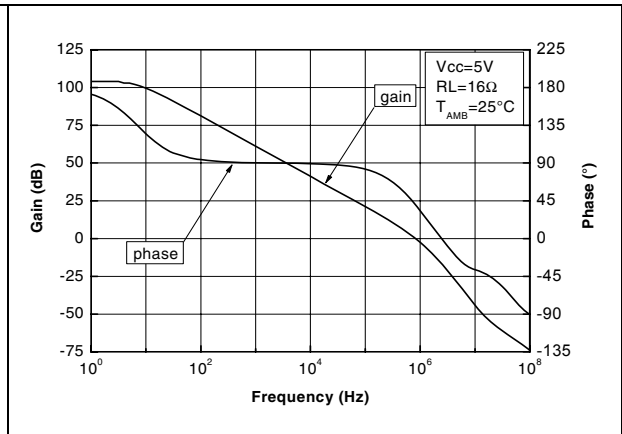

Figure 4. Open-loop frequency response

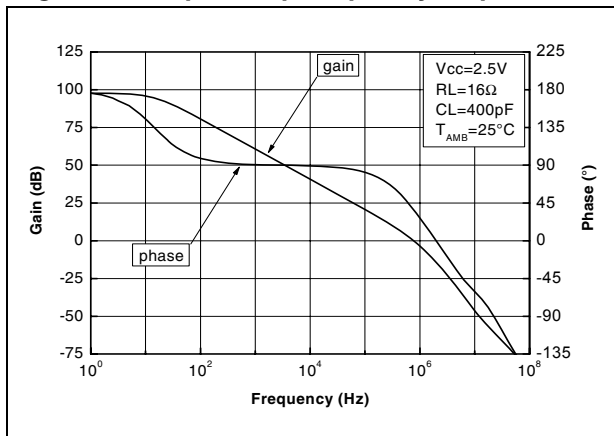

Figure 5. Open-loop frequency response

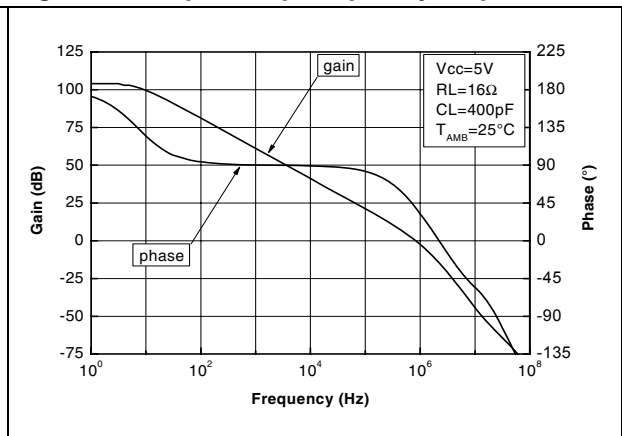

Figure 6. Open-loop frequency response

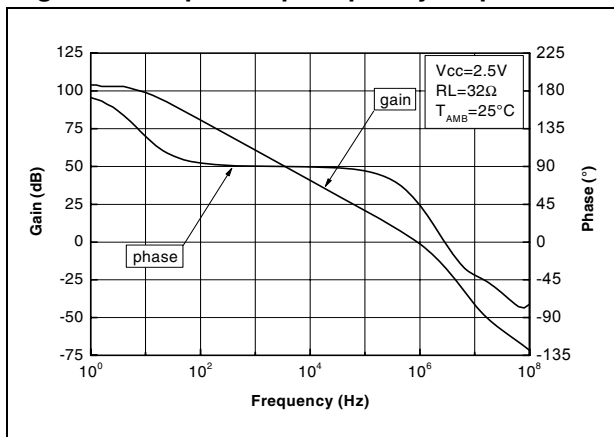

Figure 7. Open-loop frequency response

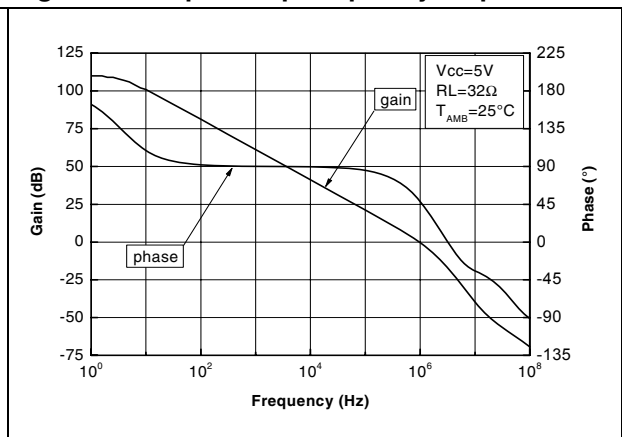

Figure 8. Open-loop frequency response

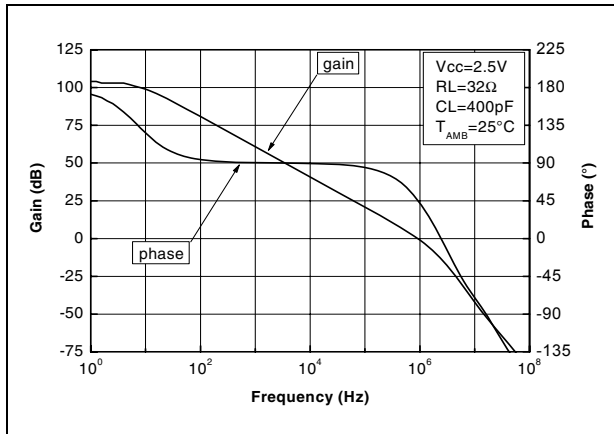

Figure 9. Open-loop frequency response

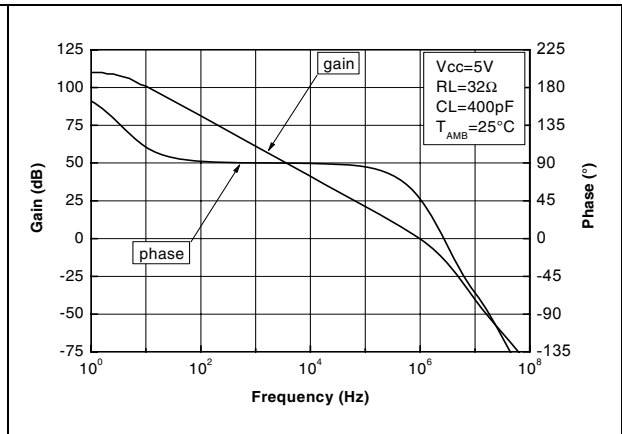

Figure 10. Open-loop frequency response

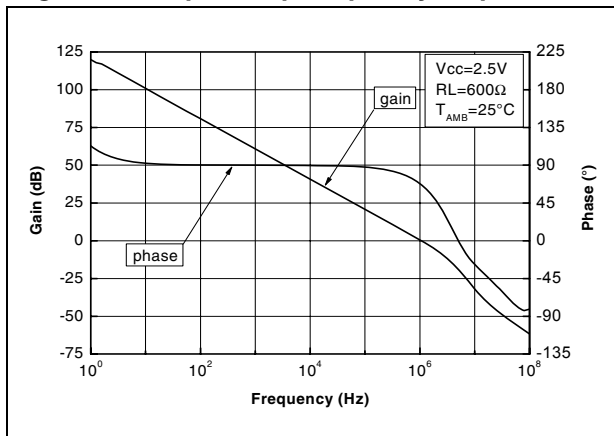

Figure 11. Open-loop frequency response

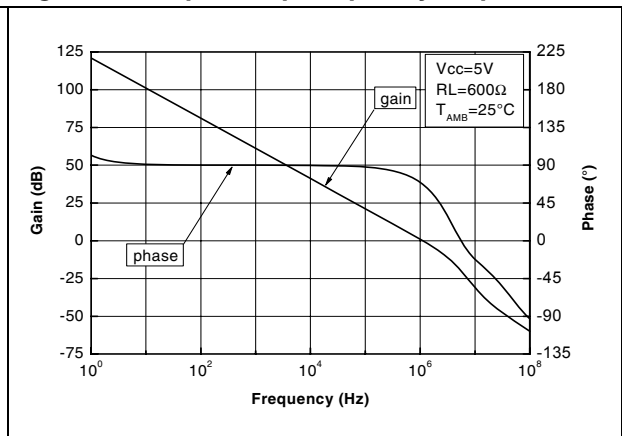

Figure 12. Power derating curves

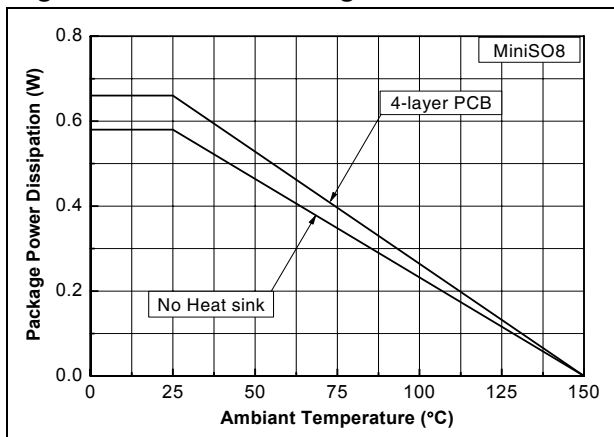

Figure 13. Power derating curves

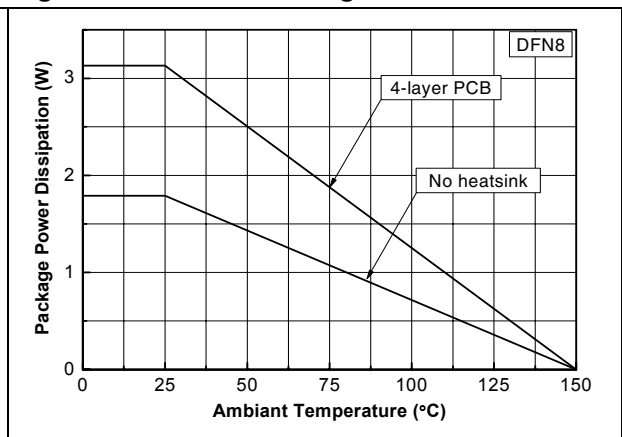

Figure 14. Signal-to-noise ratio vs. power supply voltage

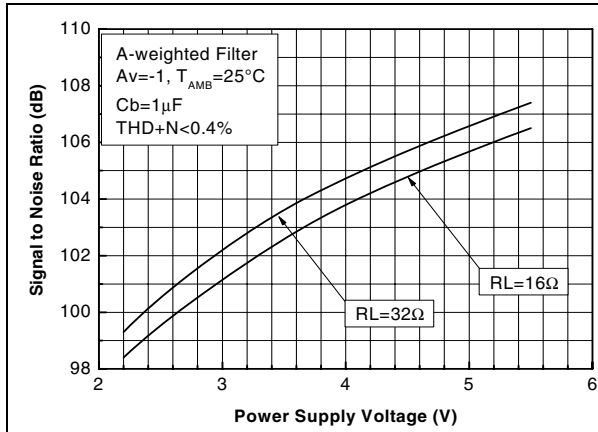

Figure 15. Signal-to-noise ratio vs. power supply voltage

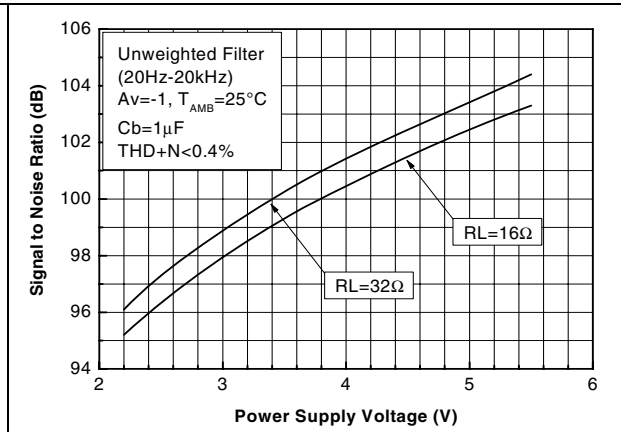

Figure 16. Signal-to-noise ratio vs. power supply voltage

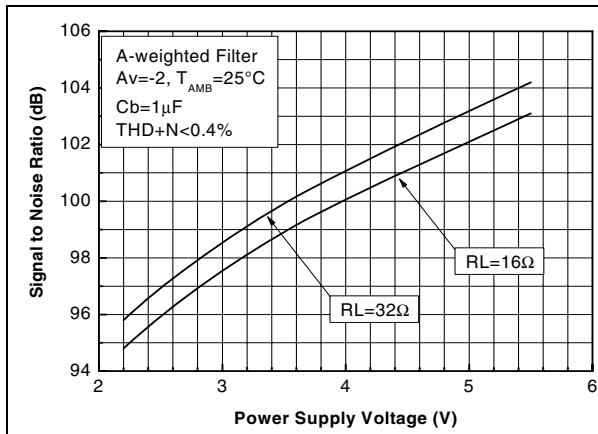

Figure 17. Signal-to-noise ratio vs. power supply voltage

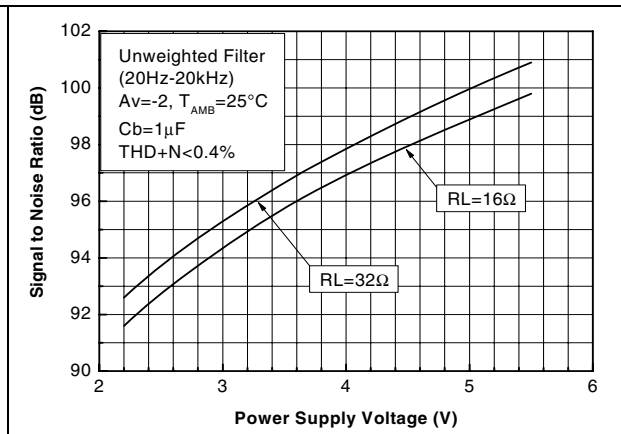

Figure 18. Signal-to-noise ratio vs. power supply voltage

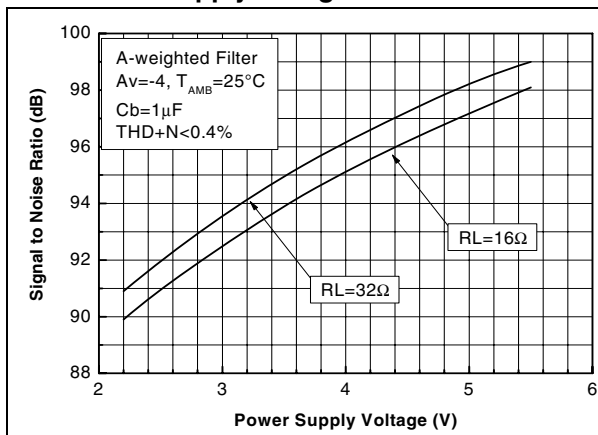

Figure 19. Signal-to-noise ratio vs. power supply voltage

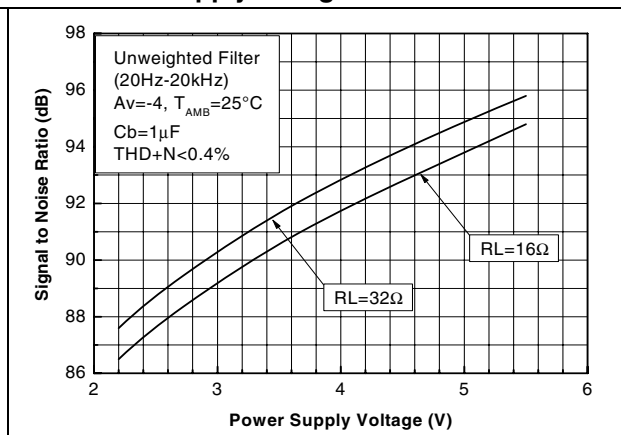

Figure 20. Power dissipation vs. output power per channel

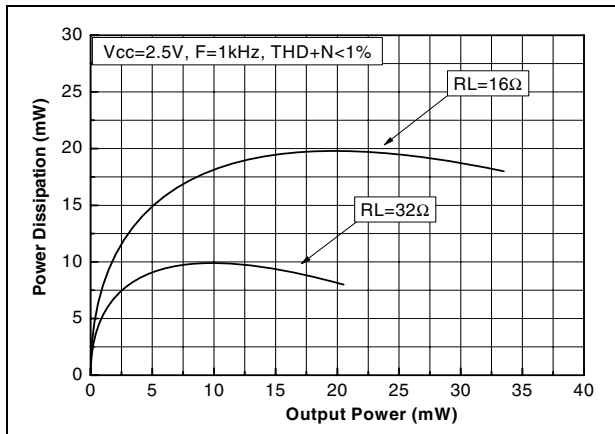

Figure 21. Power dissipation vs. output power per channel

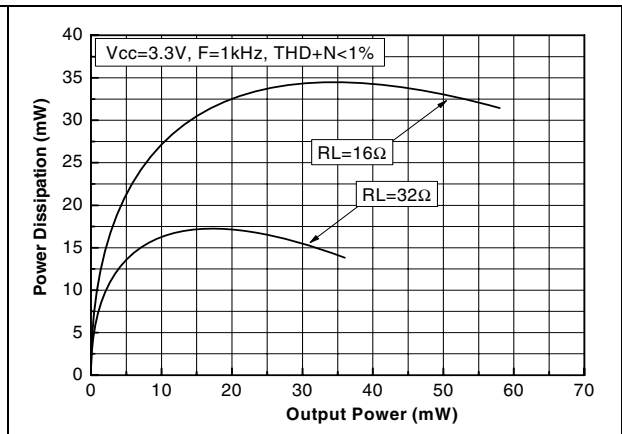

Figure 22. Power dissipation vs. output power per channel

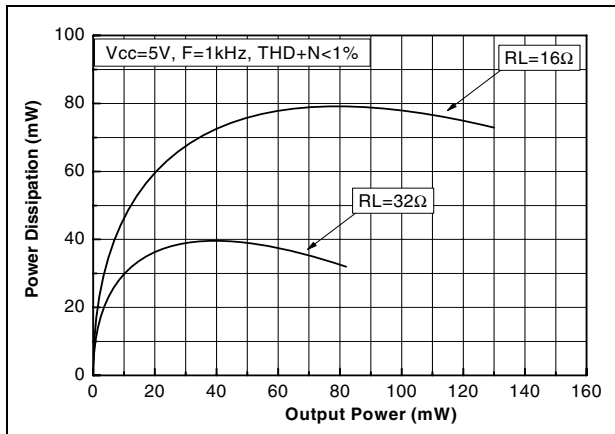

Figure 23. Power supply rejection ratio vs. frequency

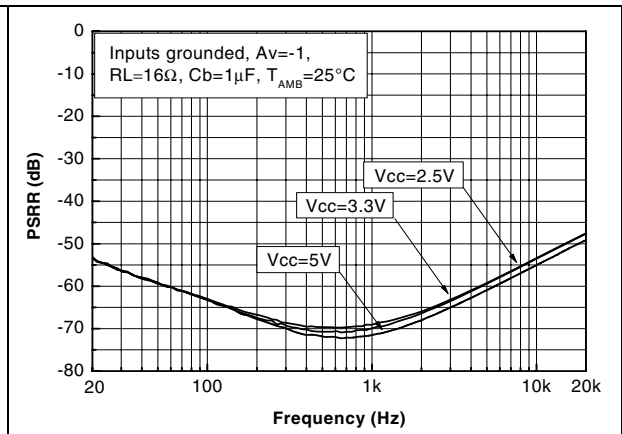

Figure 24. Power supply rejection ratio vs. frequency

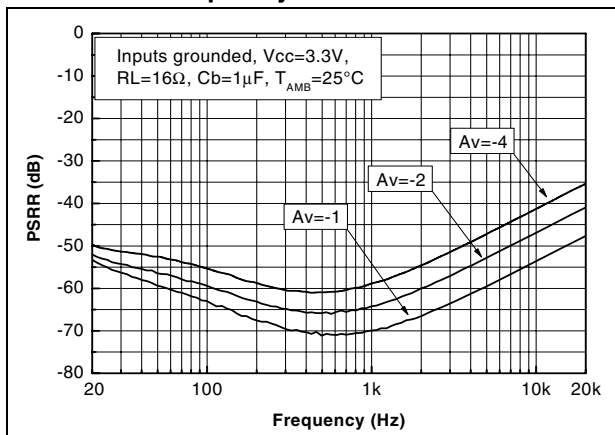

Figure 25. Power supply rejection ratio vs. frequency

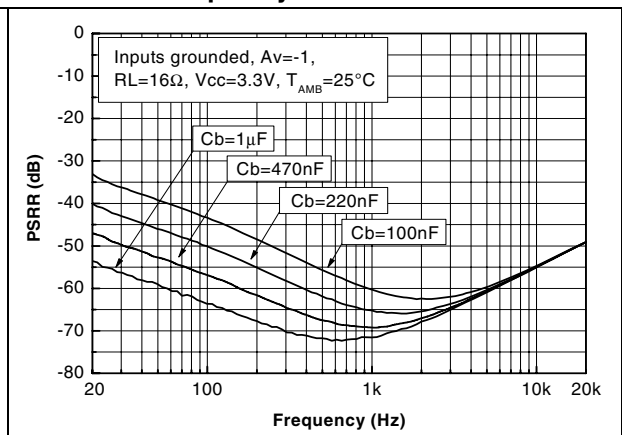

Figure 26. Total harmonic distortion plus noise vs. output power

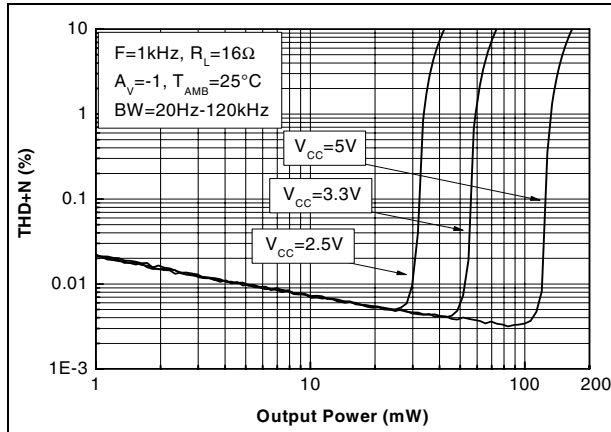

Figure 27. Total harmonic distortion plus noise vs. output power

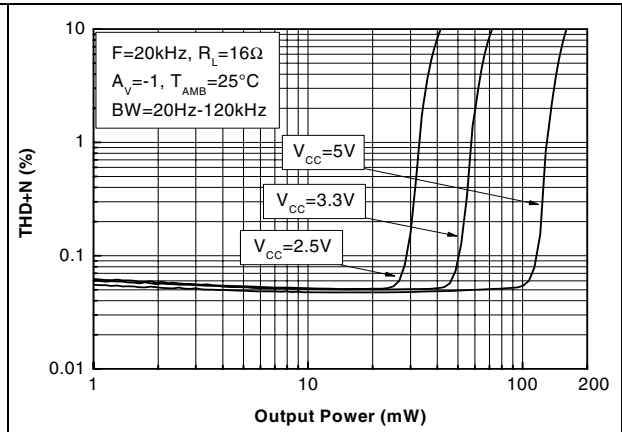

Figure 28. Total harmonic distortion plus noise vs. output power

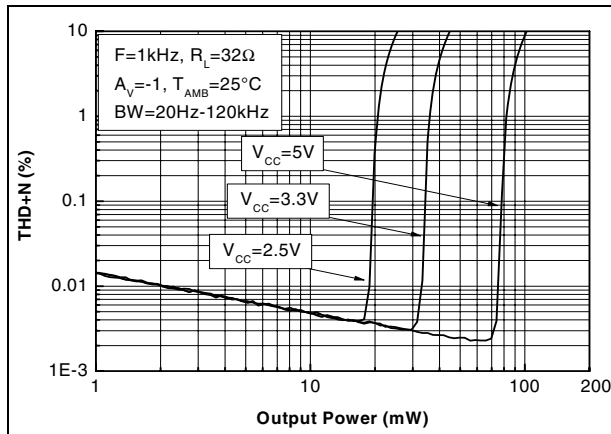

Figure 29. Total harmonic distortion plus noise vs. output power

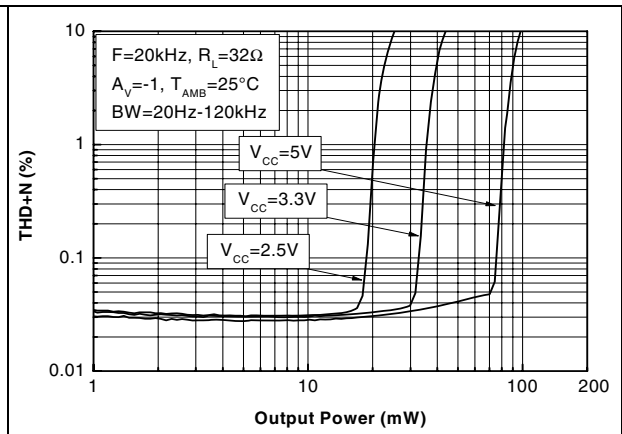

Figure 30. Total harmonic distortion plus noise vs. output power

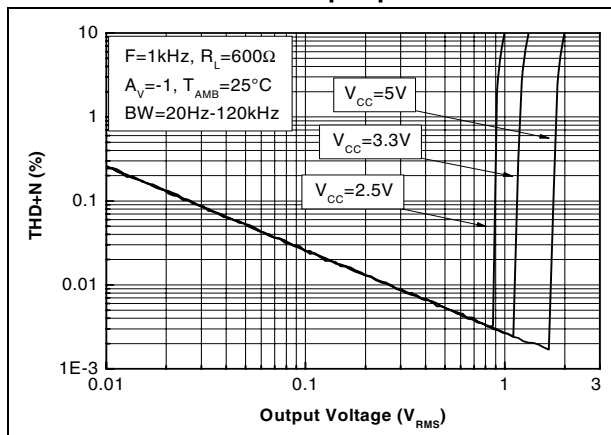

Figure 31. Total harmonic distortion plus noise vs. output power

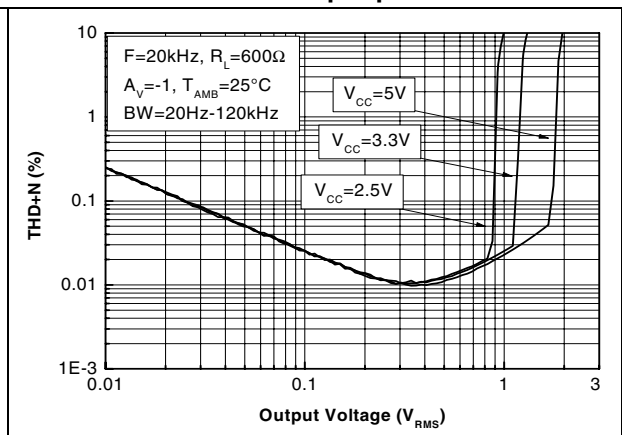

Figure 32. Total harmonic distortion plus noise vs. output power

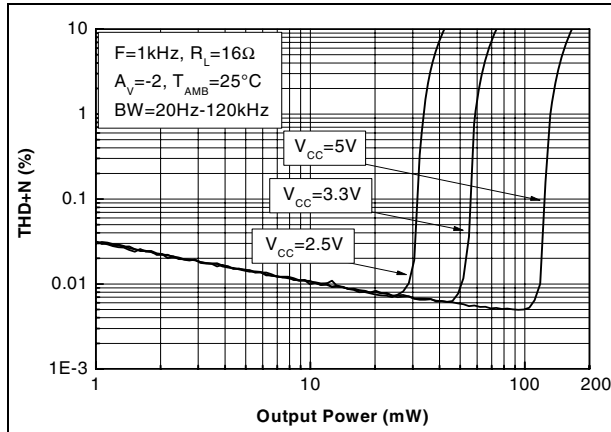

Figure 33. Total harmonic distortion plus noise vs. output power

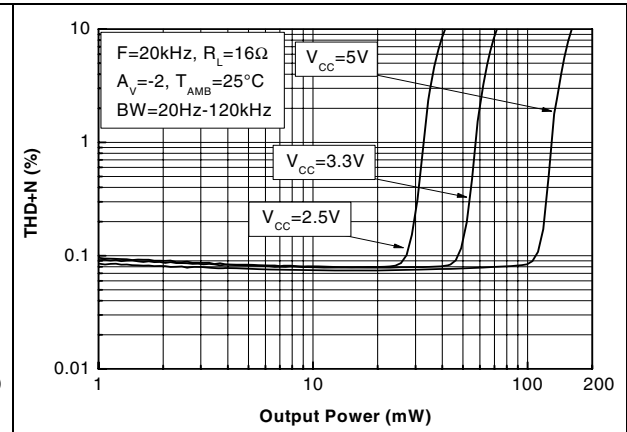

Figure 34. Total harmonic distortion plus noise vs. output power

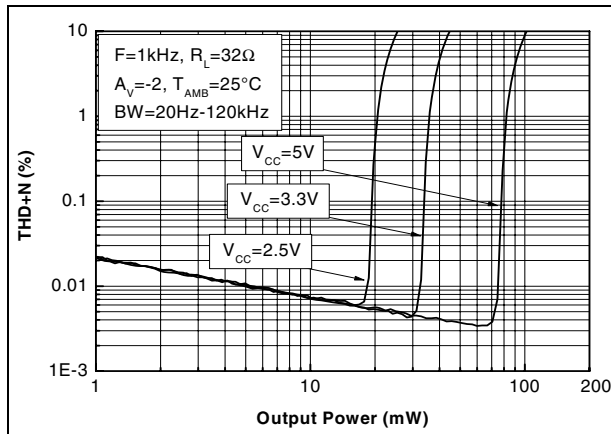

Figure 35. Total harmonic distortion plus noise vs. output power

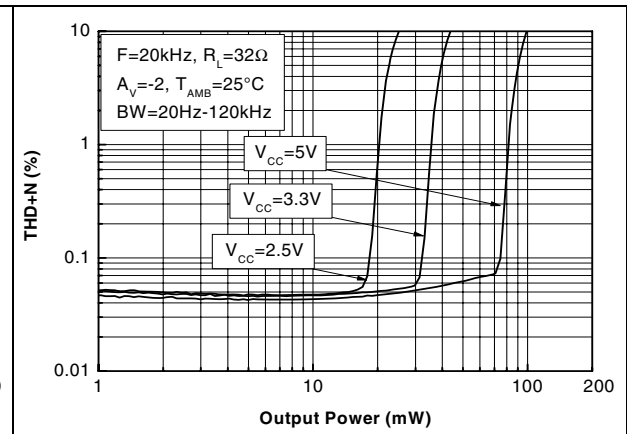

Figure 36. Total harmonic distortion plus noise vs. output power

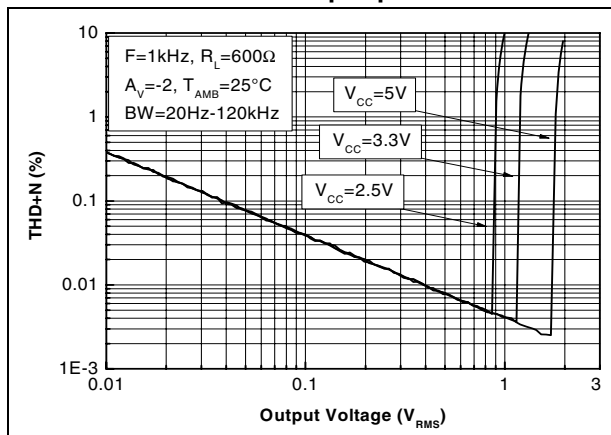

Figure 37. Total harmonic distortion plus noise vs. output power

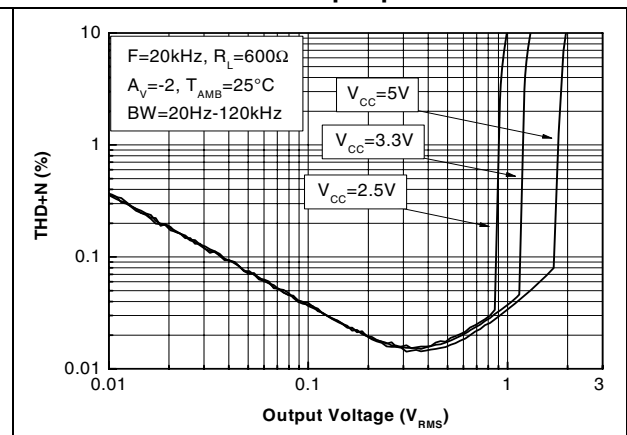

Figure 38. Total harmonic distortion plus noise vs. output power

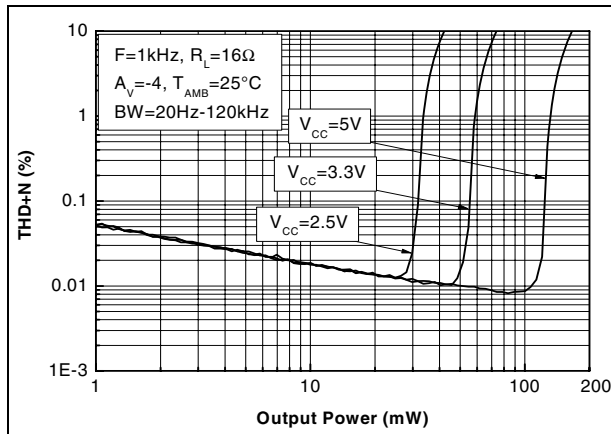

Figure 39. Total harmonic distortion plus noise vs. output power

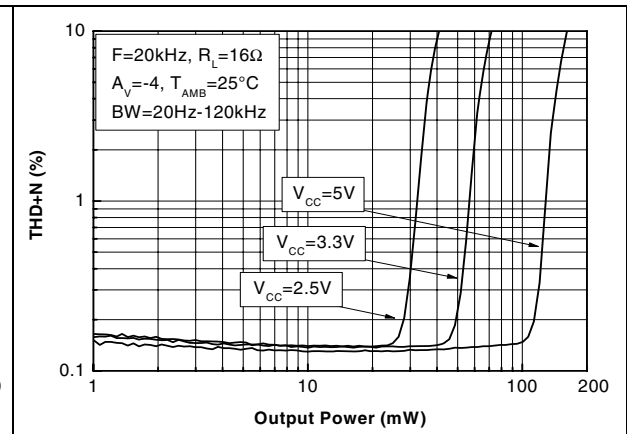

Figure 40. Total harmonic distortion plus noise vs. output power

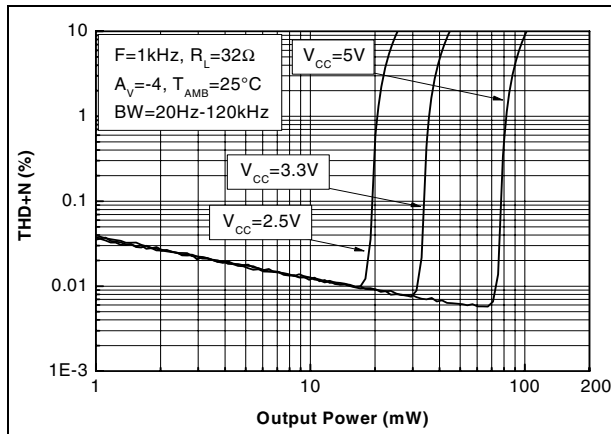

Figure 41. Total harmonic distortion plus noise vs. output power

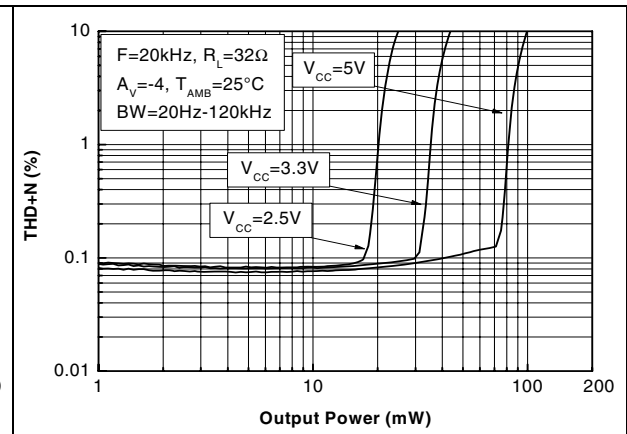

Figure 42. Total harmonic distortion plus noise vs. output power

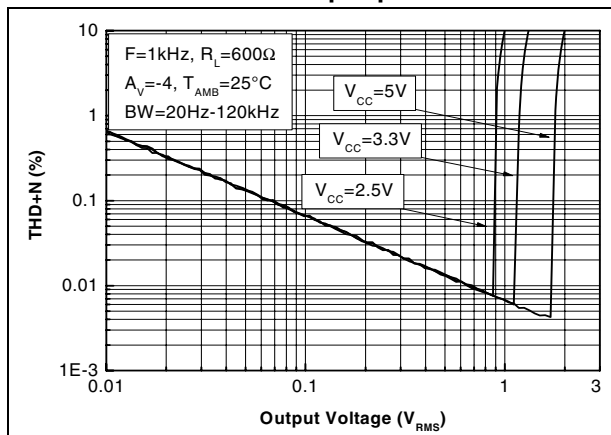

Figure 43. Total harmonic distortion plus noise vs. output power

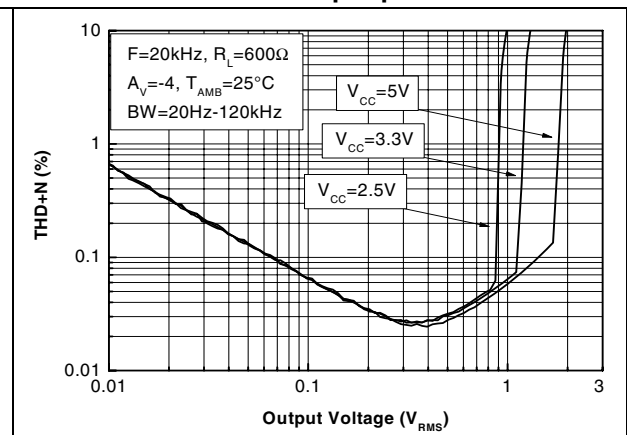

Figure 44. Total harmonic distortion plus noise vs. frequency

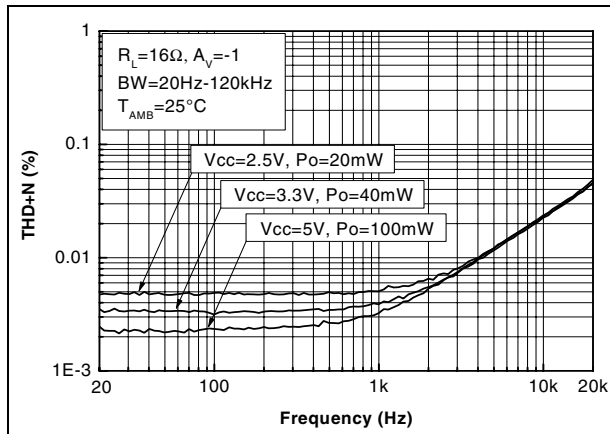

Figure 45. Total harmonic distortion plus noise vs. frequency

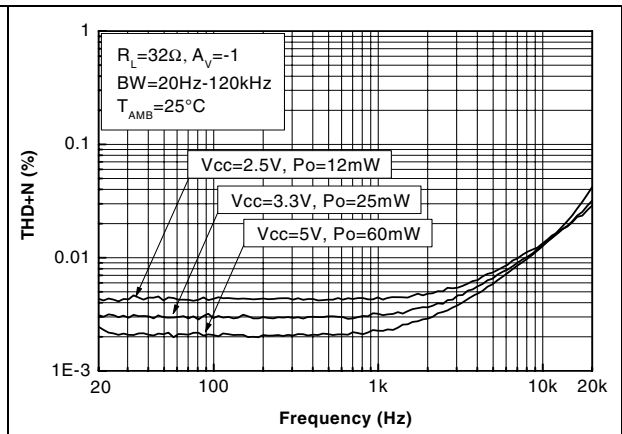

Figure 46. Total harmonic distortion plus noise vs. frequency

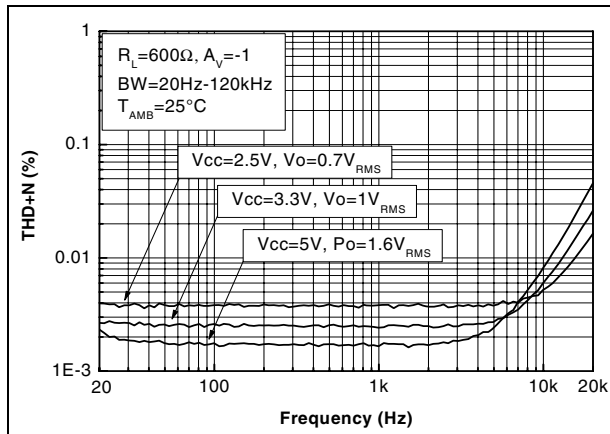

Figure 47. Total harmonic distortion plus noise vs. frequency

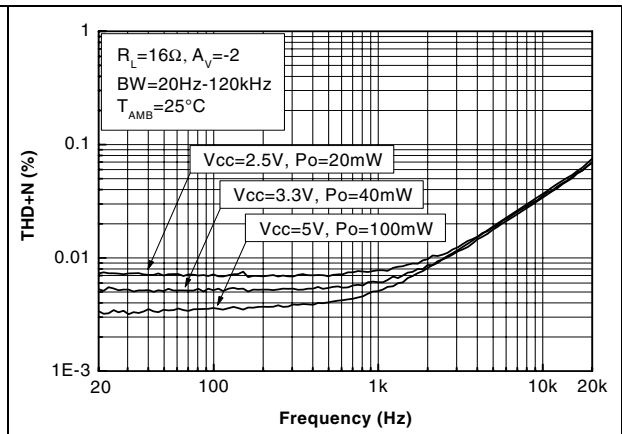

Figure 48. Total harmonic distortion plus noise vs. frequency

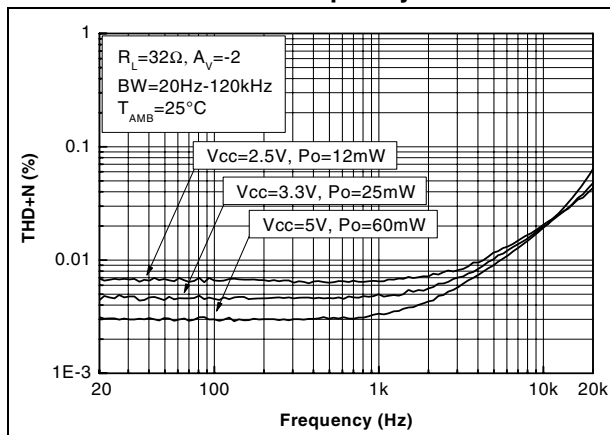

Figure 49. Total harmonic distortion plus noise vs. frequency

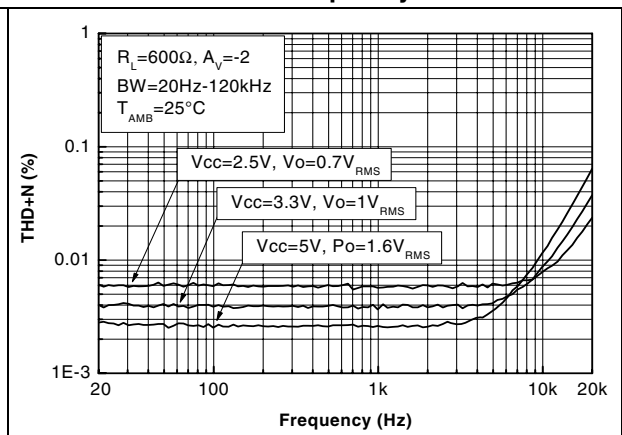

Figure 50. Total harmonic distortion plus noise vs. frequency

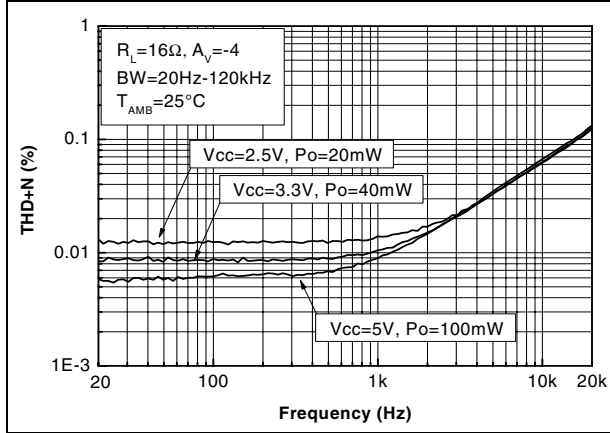

Figure 51. Total harmonic distortion plus noise vs. frequency

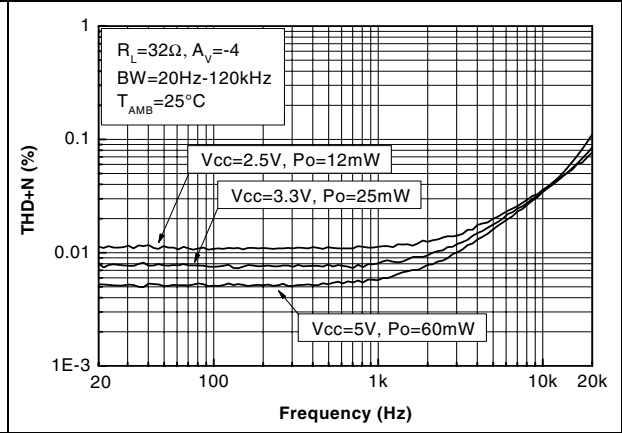

Figure 52. Total harmonic distortion plus noise vs. frequency

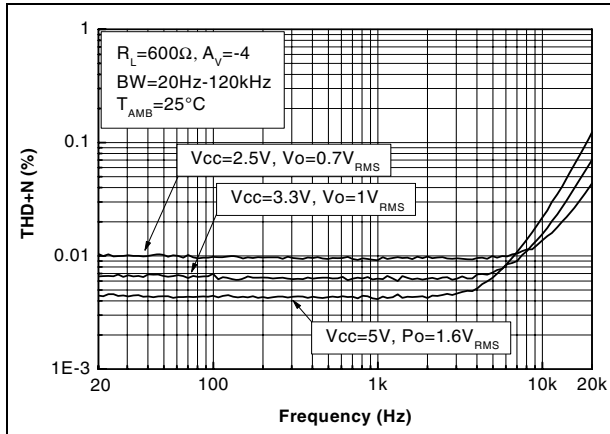

Figure 53. Output power vs. load resistance

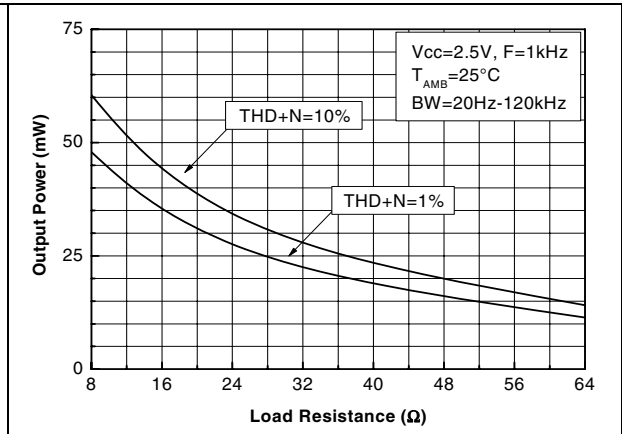

Figure 54. Output power vs. load resistance

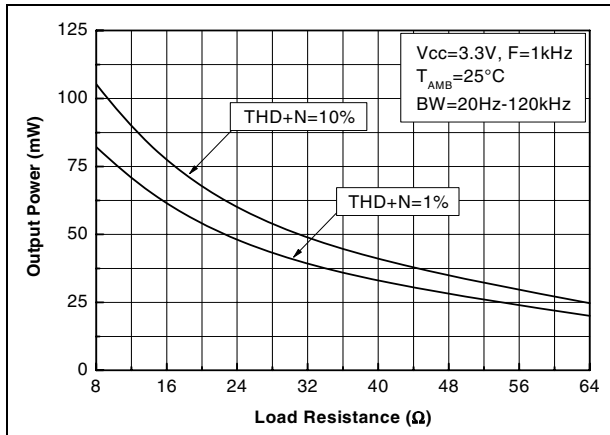

Figure 55. Output power vs. load resistance

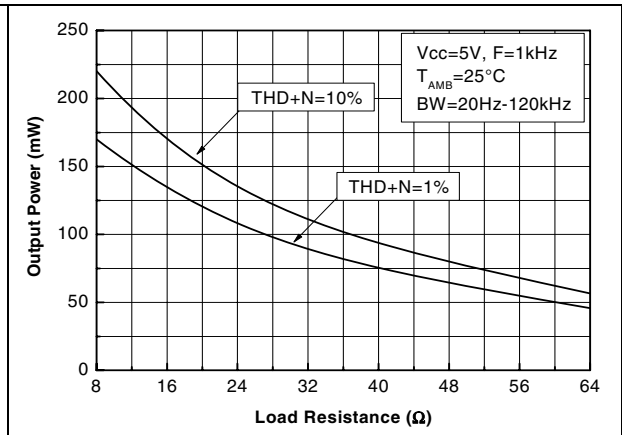

Figure 56. Output power vs. power supply voltage

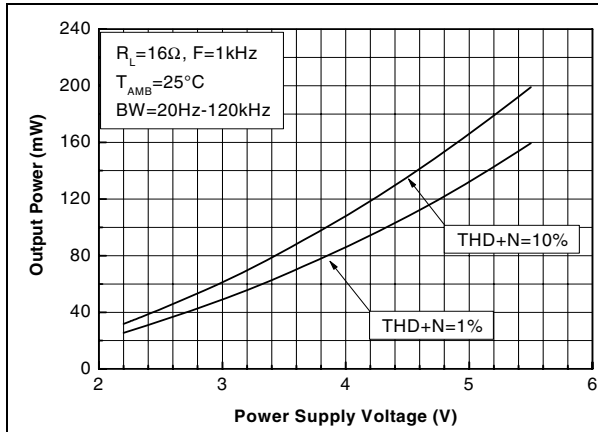

Figure 57. Output power vs. power supply voltage

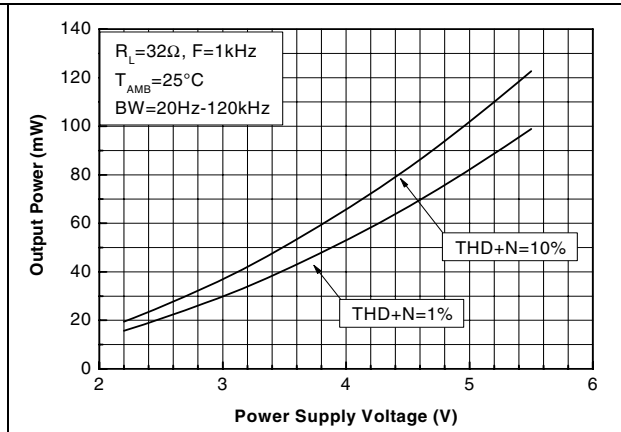

Figure 58. Output voltage swing vs. power supply voltage

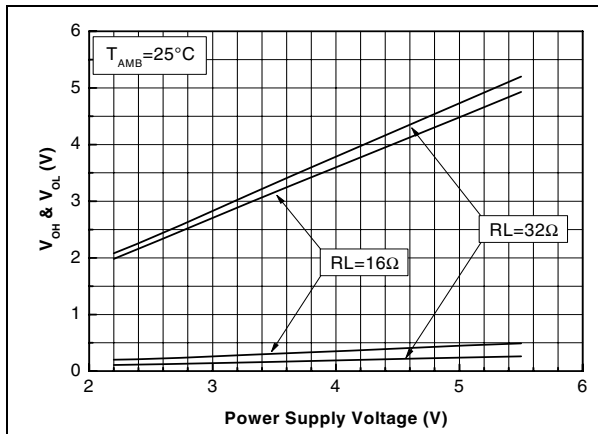

Figure 59. Current consumption vs. power supply voltage

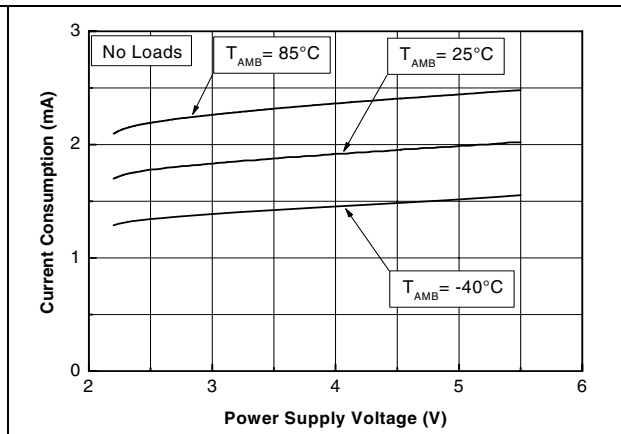

Figure 60. Current consumption vs. standby voltage

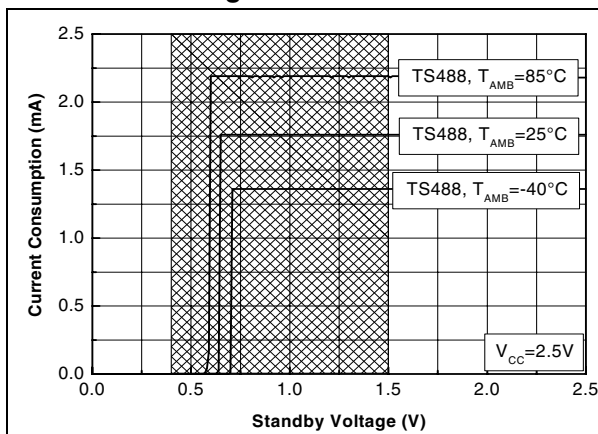

Figure 61. Current consumption vs. standby voltage

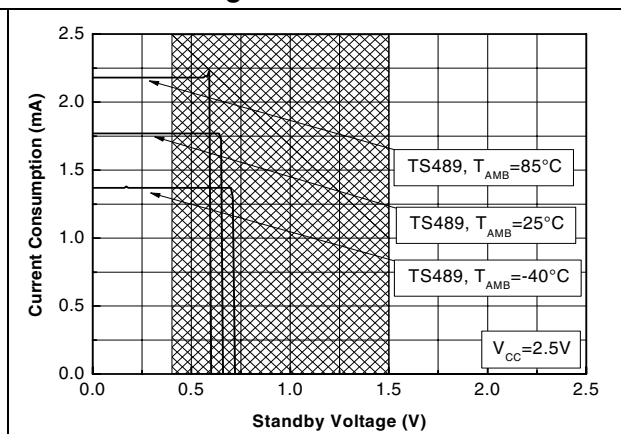

Figure 62. Current consumption vs. standby voltage

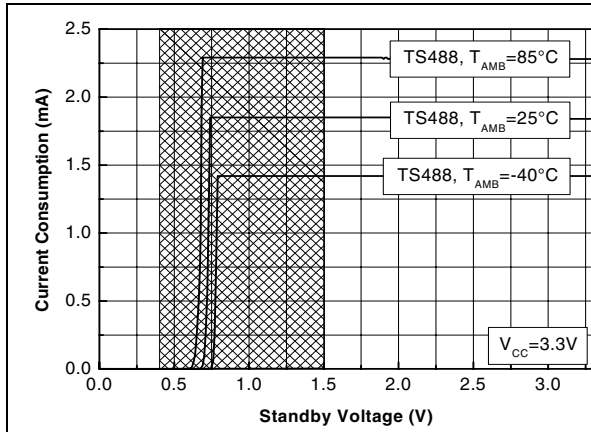

Figure 63. Current consumption vs. standby voltage

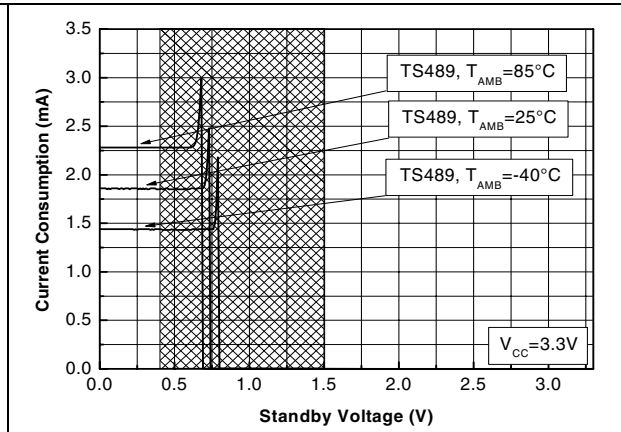

Figure 64. Current consumption vs. standby voltage

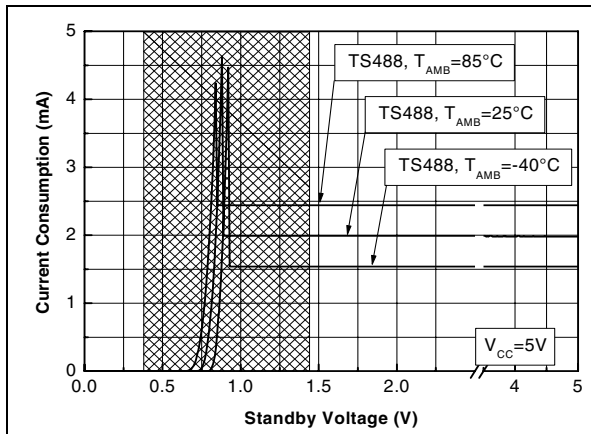

Figure 65. Current consumption vs. standby voltage

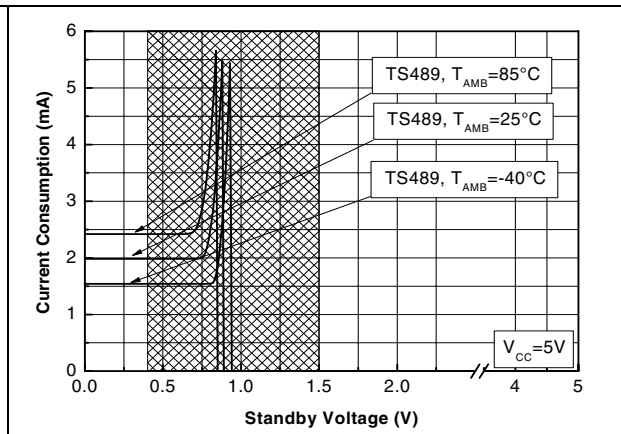

Figure 66. Crosstalk vs. frequency

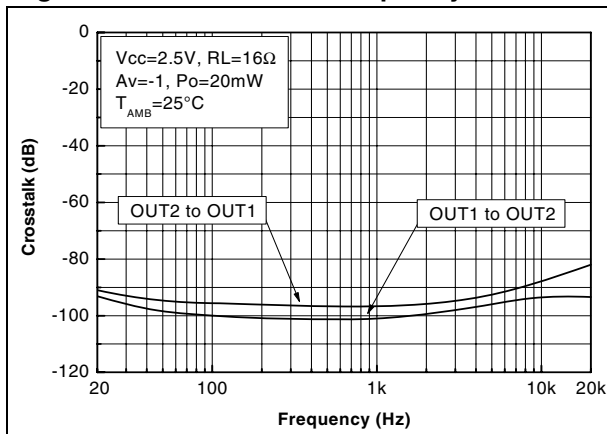

Figure 67. Crosstalk vs. frequency

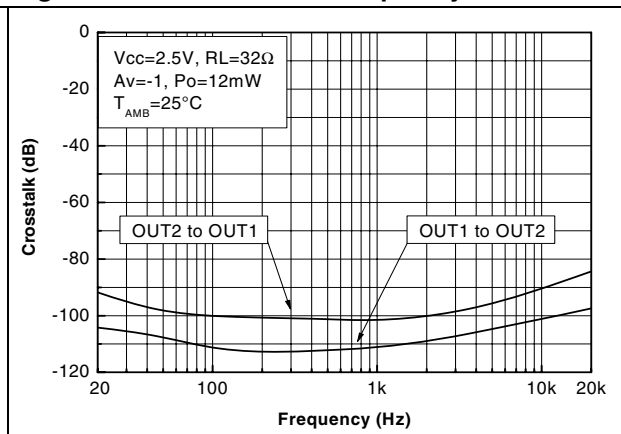

Figure 68. Crosstalk vs. frequency

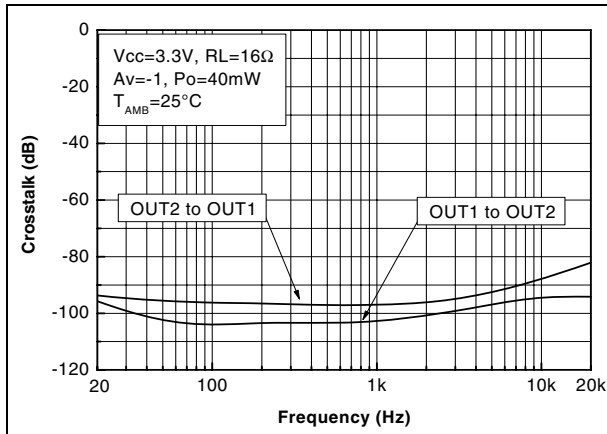

Figure 69. Crosstalk vs. frequency

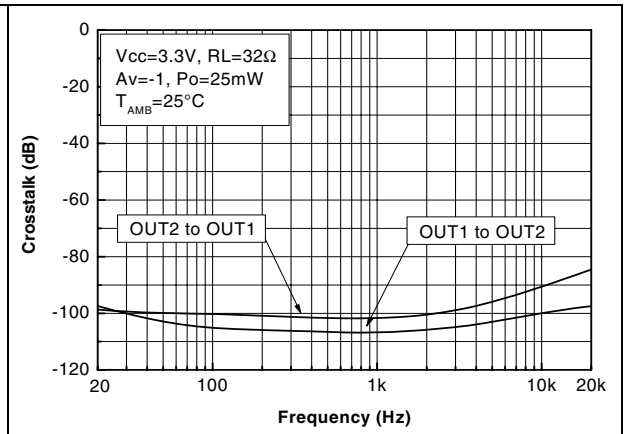

Figure 70. Crosstalk vs. frequency

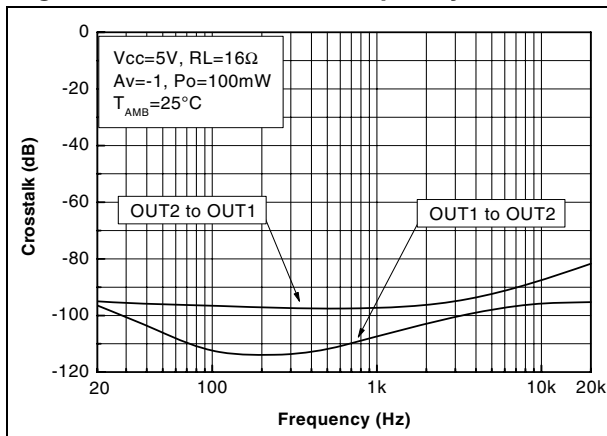

Figure 71. Crosstalk vs. frequency

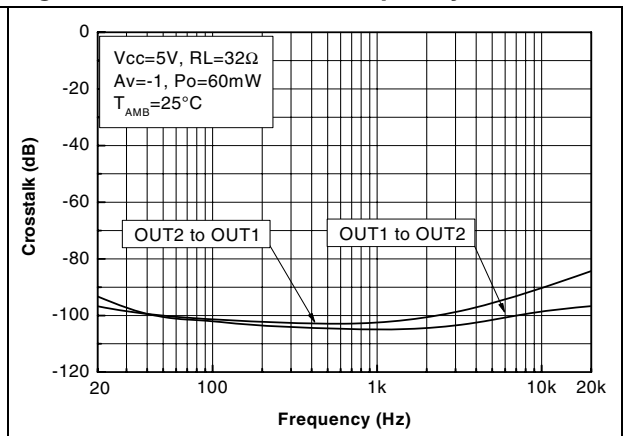

Figure 72. Crosstalk vs. frequency

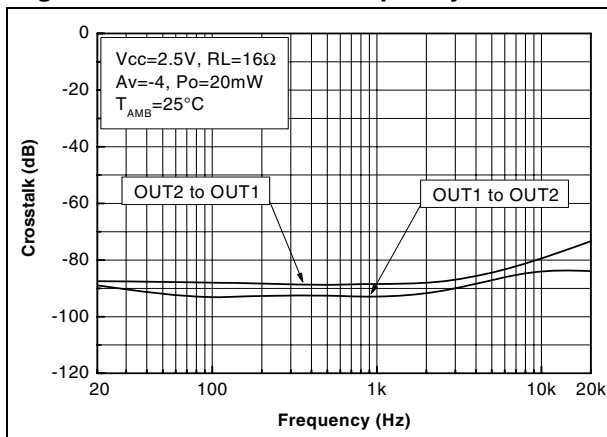

Figure 73. Crosstalk vs. frequency

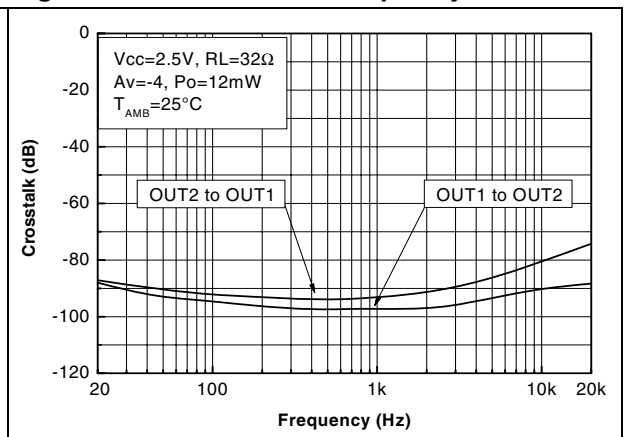

Figure 74. Crosstalk vs. frequency

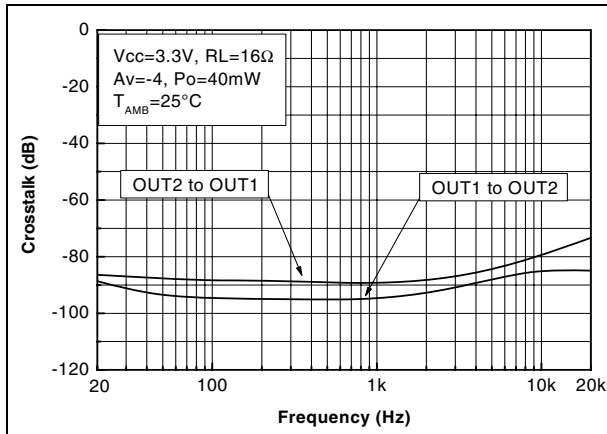

Figure 75. Crosstalk vs. frequency

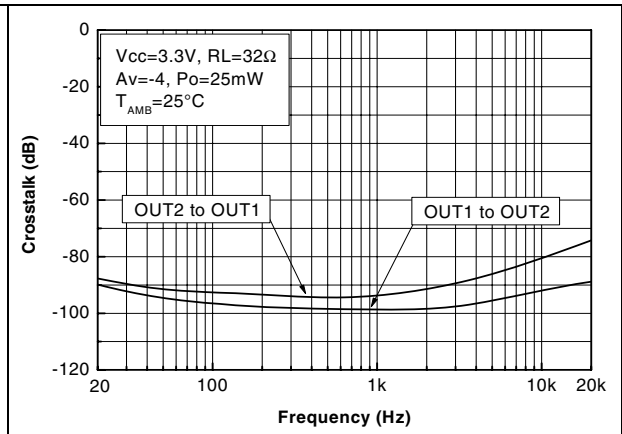

Figure 76. Crosstalk vs. frequency

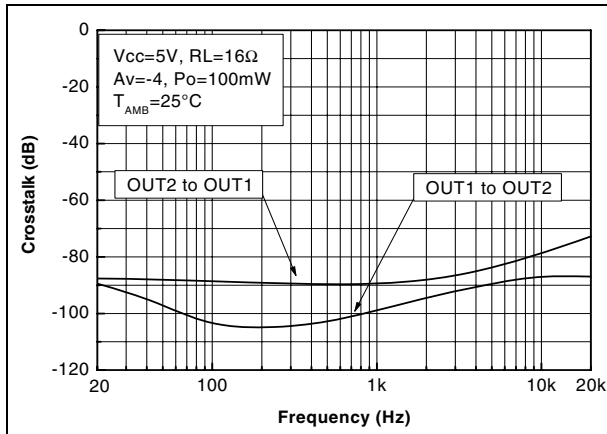
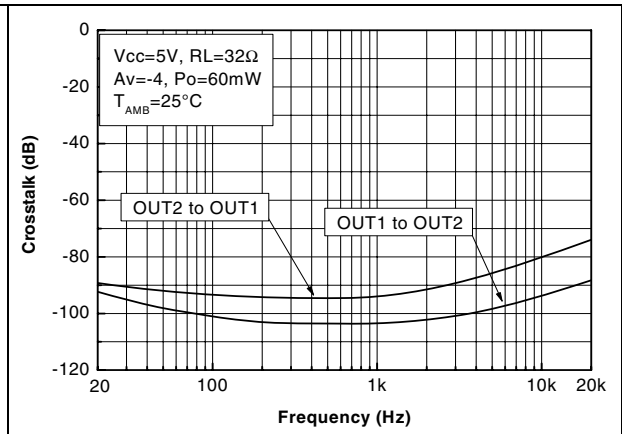

Figure 77. Crosstalk vs. frequency



4 Application information

4.1 Power dissipation and efficiency

Hypotheses:

- Voltage and current in the load are sinusoidal (V_{out} and I_{out}).
- Supply voltage is a pure DC source (V_{CC}).

Regarding the load we have:

$$V_{OUT} = V_{PEAK} \sin \omega t (V)$$

and

$$I_{OUT} = \frac{V_{OUT}}{R_L} (A)$$

and

$$P_{OUT} = \frac{V_{PEAK}^2}{2R_L} (A)$$

The average current delivered by the power supply voltage is:

$$I_{CC_{AVG}} = \frac{1}{2\pi} \int_0^{\pi} \frac{V_{PEAK}}{R_L} \sin(t) dt = \frac{V_{PEAK}}{\pi R_L} (A)$$

Figure 78. Current delivered by power supply voltage in single-ended configuration

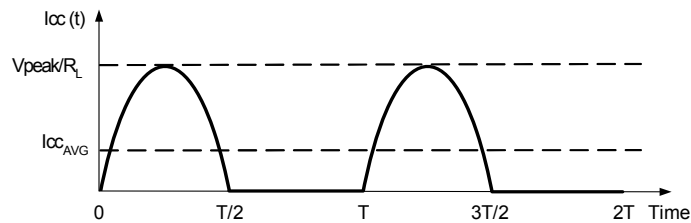

The power delivered by power supply voltage is:

$$P_{supply} = V_{CC} I_{CC_{AVG}} (W)$$

So, the power dissipation by each power amplifier is

$$P_{diss} = P_{supply} - P_{OUT} (W)$$

$$P_{diss} = \frac{\sqrt{2} V_{CC}}{\pi \sqrt{R_L}} \sqrt{P_{OUT}} - P_{OUT} (W)$$

and the maximum value is obtained when:

$$\frac{\partial P_{diss}}{\partial P_{OUT}} = 0$$

and its value is:

$$P_{\text{diss}_{\text{MAX}}} = \frac{V_{\text{CC}}^2}{\pi^2 R_L} \text{ (W)}$$

Note: This maximum value depends only on power supply voltage and load values.

The **efficiency** is the ratio between the output power and the power supply:

$$\eta = \frac{P_{\text{OUT}}}{P_{\text{supply}}} = \frac{\pi V_{\text{peak}}}{2V_{\text{CC}}}$$

The **maximum theoretical value** is reached when $V_{\text{peak}} = V_{\text{CC}}/2$, so

$$\eta = \frac{\pi}{4} = 78.5\%$$

4.2 Total power dissipation

The TS488/9 is stereo (dual channel) amplifier. It has two independent power amplifiers. Each amplifier produces heat due to its power dissipation. Therefore the maximum die temperature is the sum of each amplifier's maximum power dissipation. It is calculated as follows:

- $P_{\text{diss R}}$ = Power dissipation due to the right channel power amplifier.
- $P_{\text{diss L}}$ = Power dissipation due to the left channel power amplifier.
- Total $P_{\text{diss}} = P_{\text{diss R}} + P_{\text{diss L}}$ (W)

Typically, $P_{\text{diss R}}$ is equal to $P_{\text{diss L}}$, giving:

$$\text{Total } P_{\text{diss}} = 2P_{\text{diss R}} = 2P_{\text{diss L}}$$

$$\text{Total } P_{\text{diss}} = \frac{2\sqrt{2}V_{\text{CC}}}{\pi\sqrt{R_L}} \sqrt{P_{\text{OUT}}} - 2P_{\text{OUT}}$$

4.3 Lower cutoff frequency

The lower cutoff frequency F_{CL} of the amplifier depends on input capacitors C_{in} and output capacitors C_{out} .

The input capacitor C_{in} (output capacitor C_{out}) in serial with the input resistor R_{in} (load resistor R_L) of the amplifier is equivalent to a first order high pass filter. Assuming that F_{CL} is the lowest frequency to be amplified (with a 3 dB attenuation), the minimum value of the C_{in} (C_{out}) is:

$$C_{\text{in}} = \frac{1}{2\pi \cdot F_{\text{CL}} \cdot R_{\text{in}}}$$

$$C_{\text{out}} = \frac{1}{2\pi \cdot F_{\text{CL}} \cdot R_L}$$

Figure 79. Lower cutoff frequency vs. input capacitor

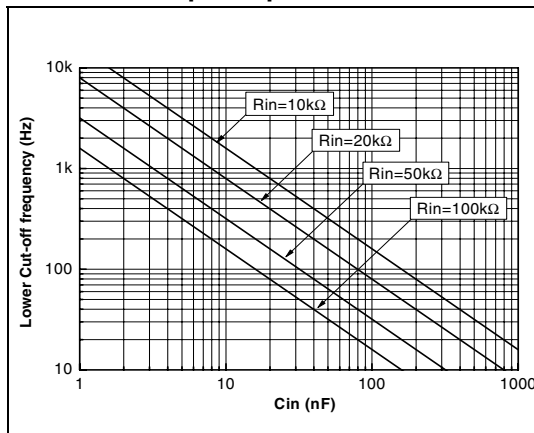
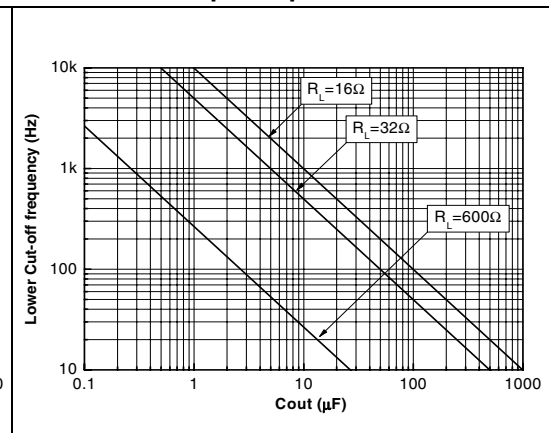

Figure 80. Lower cutoff frequency vs. output capacitor



Note: In case F_{CL} is kept the same for calculation, It must be taken in account that the 1st order high-pass filter on the input and the 1st order high-pass filter on the output create a 2nd order high-pass filter in the audio signal path with an attenuation 6 dB on F_{CL} and a roll-off 40db/decade.

4.4 Higher cutoff frequency

In the high-frequency region, you can limit the bandwidth by adding a capacitor C_{feed} in parallel with R_{feed} . It forms a low-pass filter with a -3 dB cutoff frequency F_{CH} . Assuming that F_{CH} is highest frequency to be amplified (with a 3 dB attenuation), the maximum value of C_{feed} is:

$$F_{CH} = \frac{1}{2\pi \cdot R_{feed} \cdot C_{feed}}$$

Figure 81. Higher cutoff frequency vs. feedback capacitor

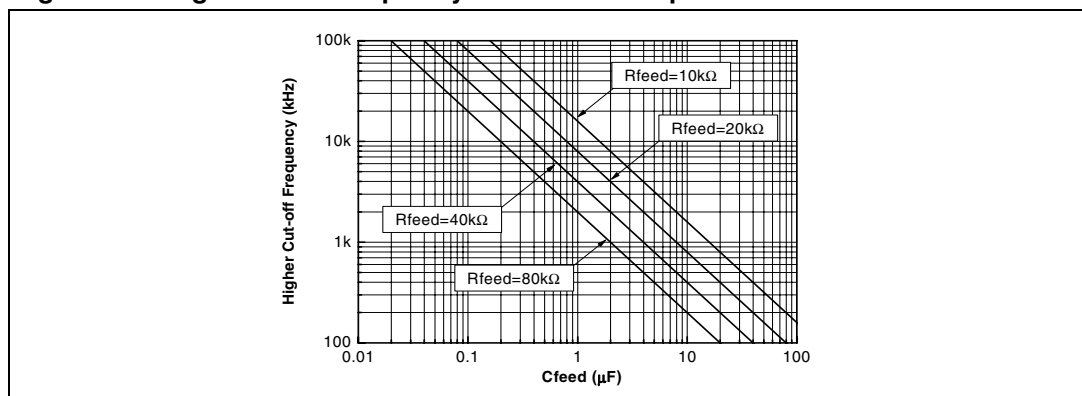

4.5 Gain setting

In the flat frequency response region (with no effect from C_{in} , C_{out} , C_{feed}), the output voltage is:

$$V_{OUT} = V_{IN} \cdot \left(-\frac{R_{feed}}{R_{in}} \right) = V_{IN} \cdot A_V$$

The gain A_V is:

$$A_V = -\frac{R_{feed}}{R_{in}}$$

4.6 Decoupling of the circuit

Two capacitors are needed to properly bypass the TS488 (TS489), a power supply capacitor C_s and a bias voltage bypass capacitor C_b .

C_s has a strong influence on the THD+N in the high frequency range (above 7kHz) and indirectly on the power supply disturbances. With 1 μ F, you can expect THD+N performance to be similar to the one shown in the datasheet. If C_s is lower than 1 μ F, the THD+N increases in the higher frequencies and disturbances on the power supply rail are less filtered. On the contrary, if C_s is higher than 1 μ F, the disturbances on the power supply rail are more filtered.

C_b has an influence on the THD+N in the low frequency range. Its value is critical on the PSRR with grounded inputs in the lower frequencies:

- If C_b is lower than 1 μ F, the THD+N improves and the PSRR worsens.
- If C_b is higher than 1 μ F, the benefit on the THD+N and PSRR is small.

Note: The input capacitor C_{in} also has a significant effect on the PSRR at lower frequencies. The lower the value of C_{in} , the higher the PSRR.

4.7 Standby mode

When the standby mode is activated an internal circuit of the TS488 (TS489) is charged (see [Figure 82](#)). A time required to change the internal circuit is a few microseconds.

Figure 82. Internal equivalent schematic of the TS488 (TS489) in standby mode

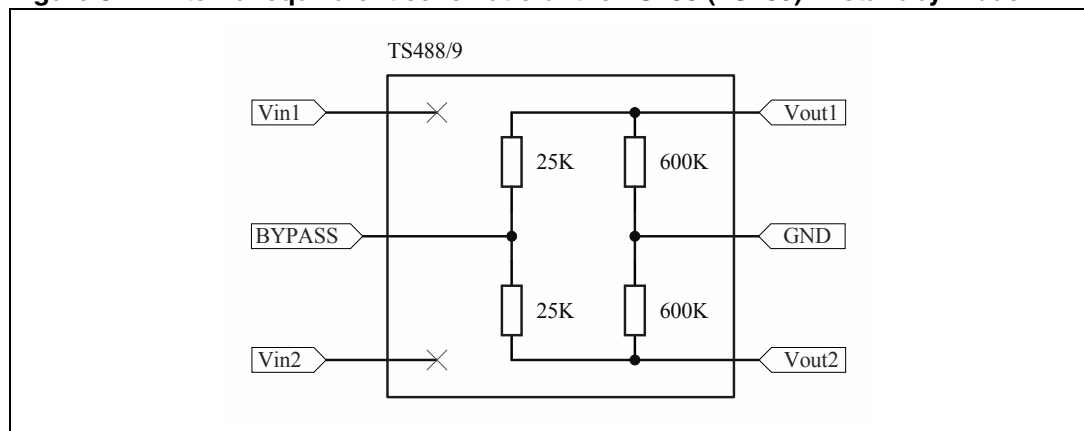

4.8 Wake-up time

When the standby is released to put the device ON, the bypass capacitor C_b is charged immediately. As C_b is directly linked to the bias of the amplifier, the bias will not work properly until the C_b voltage is correct. The time to reach this voltage plus a time delay of 20 ms (pop precaution) is called the wake-up time or t_{WU} ; it is specified in the electrical characteristics table with $C_b = 1\mu F$.

If C_b has a value other than $1\mu F$, t_{WU} can be calculated by applying the following formulas or can be read directly from [Figure 83](#).

$$t_{WU} = \frac{C_b \cdot 2.5}{0.03125} + 20 \text{ [ms;}\mu F]$$

Figure 83. Typical wake-up time vs. bypass capacitance

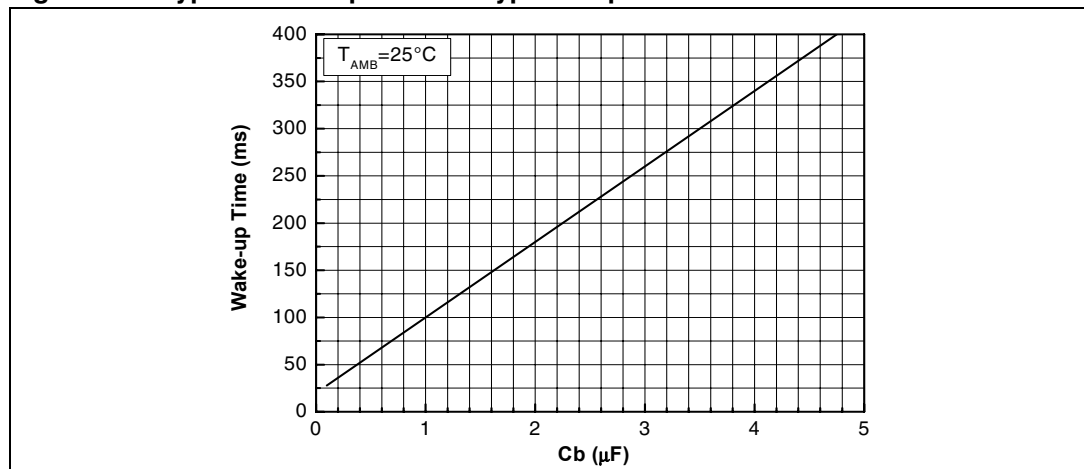

Note: It is assumed that the C_b voltage is equal to 0V. If the C_b voltage is not equal to 0V, the wake-up time is shorter.

4.9 POP performance

Pop performance is closely related to the size of the input capacitor C_{in} . The size of C_{in} is dependent on the lower cutoff frequency and PSRR values requested.

In order to reach low pop, C_{in} must be charged to $V_{CC}/2$ in less than 20 ms. To follow this rule, the equivalent input constant time ($R_{in}C_{in}$) should be less than 6.7 ms:

$$\tau_{in} = R_{in} \times C_{in} < 0.0067 \text{ (s)}$$

Example calculation:

In the typical application schematic R_{in} is 20 kΩ and C_{in} is 330 nF. The lower cutoff frequency (-3 db attenuation) is given by the following formula:

$$F_{CL} = \frac{1}{2\pi \cdot R_{in} \cdot C_{in}}$$

With the values above, the result is $F_{CL} = 25 \text{ Hz}$.

In this case, $\tau_{in} = R_{in} \times C_{in} = 6.6 \text{ ms}$.

This value is sufficient with regard to the previous formula, thus we can state that the pop is imperceptible.

Connecting the headphones

Generally headphones are connected using jack connectors. To prevent a pop in the headphones when plugging in the jack, a pulldown resistor should be connected in parallel with each headphone output. This allows the capacitors C_{out} to be charged even when the headphones are not plugged in.

Pulldown resistors with a value of 1 k Ω are high enough to be a negligible load, and low enough to charge the capacitors C_{out} in less than one second.

Note: The pop&click reduction circuitry works properly only when both channels have the same value for the external components C_{in} , C_{out} , R_{load} and $R_{pulldown}$.

5 Package mechanical data

In order to meet environmental requirements, ST offers these devices in different grades of ECOPACK[®] packages, depending on their level of environmental compliance. ECOPACK[®] specifications, grade definitions and product status are available at: www.st.com. ECOPACK[®] is an ST trademark.

5.1 MiniSO-8 package

| miniSO-8 MECHANICAL DATA | | | | | | |
|--------------------------|------|------|------|-------|-------|-------|
| DIM. | mm. | | | inch | | |
| | MIN. | TYP. | MAX. | MIN. | TYP. | MAX. |
| A | | | 1.1 | | | 0.043 |
| A1 | 0.05 | 0.10 | 0.15 | 0.002 | 0.004 | 0.006 |
| A2 | 0.78 | 0.86 | 0.94 | 0.031 | 0.031 | 0.037 |
| b | 0.25 | 0.33 | 0.40 | 0.010 | 0.13 | 0.013 |
| c | 0.13 | 0.18 | 0.23 | 0.005 | 0.007 | 0.009 |
| D | 2.90 | 3.00 | 3.10 | 0.114 | 0.118 | 0.122 |
| E | 4.75 | 4.90 | 5.05 | 0.187 | 0.193 | 0.199 |
| E1 | 2.90 | 3.00 | 3.10 | .0114 | 0.118 | 0.122 |
| e | | 0.65 | | | 0.026 | |
| K | 0° | | 6° | 0° | | 6° |
| L | 0.40 | 0.55 | 0.70 | 0.016 | 0.022 | 0.028 |
| L1 | | | 0.10 | | | 0.004 |

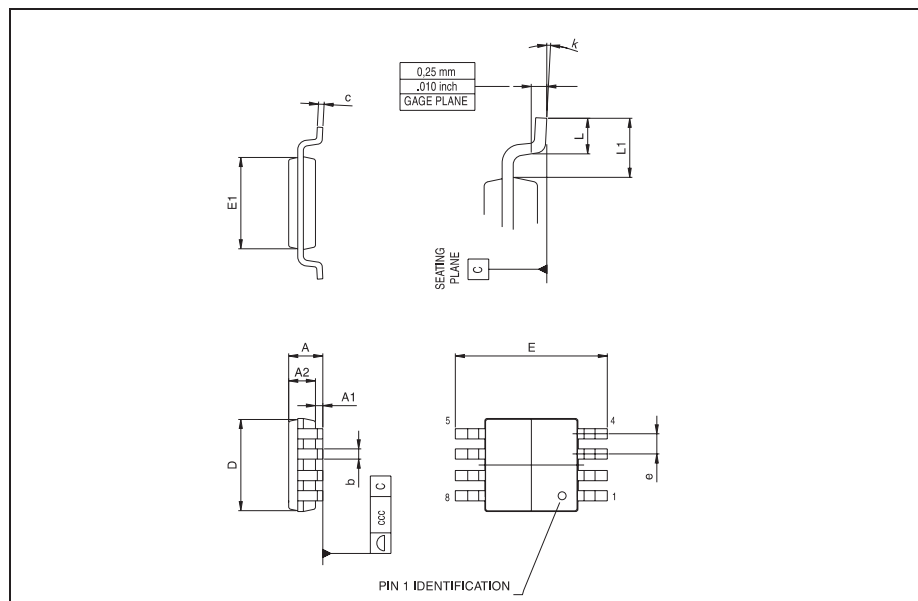

5.2 DFN8 package

| DFN8 (2x2) MECHANICAL DATA | | | | | | |
|----------------------------|------|------|------|-------|-------|-------|
| DIM. | mm. | | | inch | | |
| | MIN. | TYP. | MAX. | MIN. | TYP. | MAX. |
| A | 0.51 | 0.55 | 0.60 | 0.020 | 0.022 | 0.024 |
| A1 | | | 0.05 | | | 0.002 |
| A3 | | 0.15 | | | 0.006 | |
| b | 0.18 | 0.25 | 0.30 | 0.007 | 0.010 | 0.012 |
| D | 1.85 | 2.00 | 2.15 | 0.073 | 0.079 | 0.085 |
| D2 | 1.45 | 1.60 | 1.70 | 0.057 | 0.063 | 0.067 |
| E | 1.85 | 2.00 | 2.15 | 0.073 | 0.079 | 0.085 |
| E2 | 0.75 | 0.90 | 1.00 | 0.030 | 0.035 | 0.039 |
| e | | 0.50 | | | 0.020 | |
| L | | | 0.50 | | | 0.020 |
| ddd | | | 0.08 | | | 0.003 |

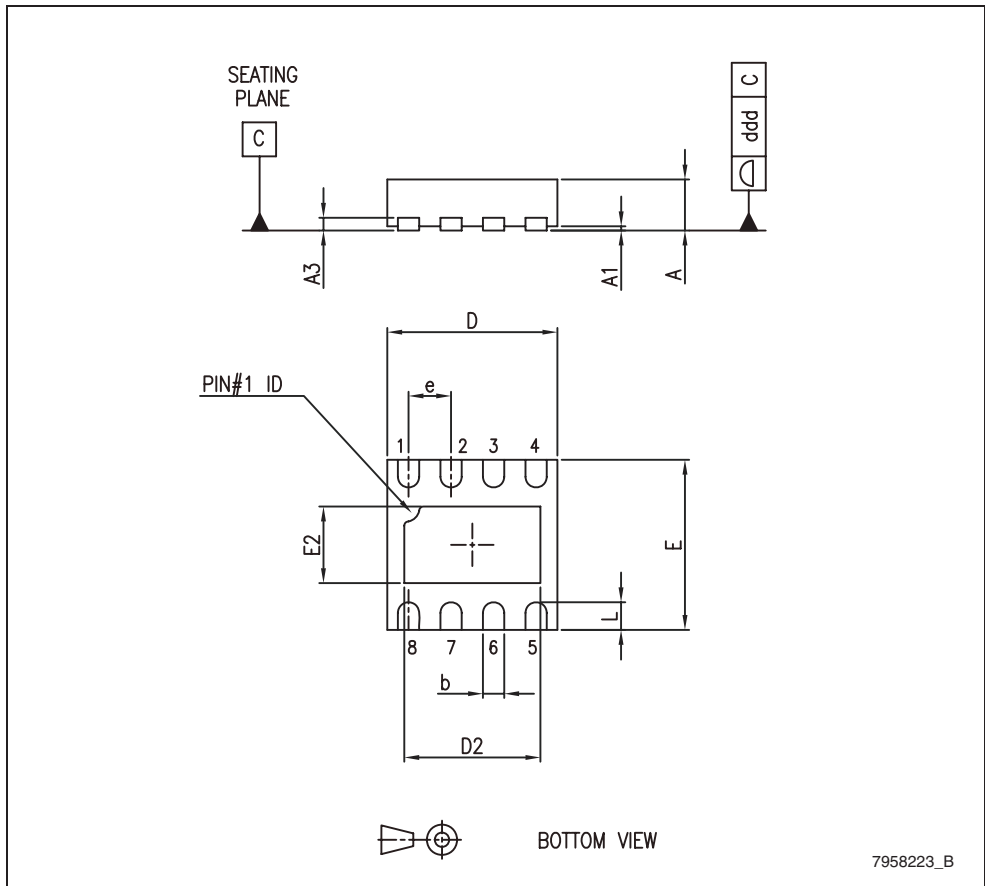

6 Ordering information

Table 8. Order codes

| Part number | Temperature range | Package | Packing | Marking |
|-------------|-------------------|----------|-------------|---------|
| TS488IST | -40°C to +85°C | MiniSO-8 | Tape & reel | K488 |
| TS488IQT | | DFN8 | | K88 |

7 Revision history

Table 9. Document revision history

| Date | Revision | Changes |
|-------------|----------|---|
| 2-Jan-2006 | 1 | First release corresponding to the product preview version. |
| 1-Feb-2006 | 2 | Removal of typical application schematic on first page (it appears in Figure 1 on page 3). Minor grammatical and formatting corrections throughout. |
| 4-Aug-2006 | 3 | Update of marking. Update of DFN8 package height. Editorial update. |
| 15-Sep-2006 | 4 | Revision corresponding to the release to production of the TS488 - TS489. |
| 14-May-2012 | 5 | Removed obsolete part numbers TS489IQT and TS489IST from the cover page and Table 8: Order codes . Updated ECOPACK® text in Section 5: Package mechanical data . Updated package in Section 5.2: DFN8 package . |

Please Read Carefully:

Information in this document is provided solely in connection with ST products. STMicroelectronics NV and its subsidiaries ("ST") reserve the right to make changes, corrections, modifications or improvements, to this document, and the products and services described herein at any time, without notice.

All ST products are sold pursuant to ST's terms and conditions of sale.

Purchasers are solely responsible for the choice, selection and use of the ST products and services described herein, and ST assumes no liability whatsoever relating to the choice, selection or use of the ST products and services described herein.

No license, express or implied, by estoppel or otherwise, to any intellectual property rights is granted under this document. If any part of this document refers to any third party products or services it shall not be deemed a license grant by ST for the use of such third party products or services, or any intellectual property contained therein or considered as a warranty covering the use in any manner whatsoever of such third party products or services or any intellectual property contained therein.

UNLESS OTHERWISE SET FORTH IN ST'S TERMS AND CONDITIONS OF SALE ST DISCLAIMS ANY EXPRESS OR IMPLIED WARRANTY WITH RESPECT TO THE USE AND/OR SALE OF ST PRODUCTS INCLUDING WITHOUT LIMITATION IMPLIED WARRANTIES OF MERCHANTABILITY, FITNESS FOR A PARTICULAR PURPOSE (AND THEIR EQUIVALENTS UNDER THE LAWS OF ANY JURISDICTION), OR INFRINGEMENT OF ANY PATENT, COPYRIGHT OR OTHER INTELLECTUAL PROPERTY RIGHT.

UNLESS EXPRESSLY APPROVED IN WRITING BY TWO AUTHORIZED ST REPRESENTATIVES, ST PRODUCTS ARE NOT RECOMMENDED, AUTHORIZED OR WARRANTED FOR USE IN MILITARY, AIR CRAFT, SPACE, LIFE SAVING, OR LIFE SUSTAINING APPLICATIONS, NOR IN PRODUCTS OR SYSTEMS WHERE FAILURE OR MALFUNCTION MAY RESULT IN PERSONAL INJURY, DEATH, OR SEVERE PROPERTY OR ENVIRONMENTAL DAMAGE. ST PRODUCTS WHICH ARE NOT SPECIFIED AS "AUTOMOTIVE GRADE" MAY ONLY BE USED IN AUTOMOTIVE APPLICATIONS AT USER'S OWN RISK.

Resale of ST products with provisions different from the statements and/or technical features set forth in this document shall immediately void any warranty granted by ST for the ST product or service described herein and shall not create or extend in any manner whatsoever, any liability of ST.

ST and the ST logo are trademarks or registered trademarks of ST in various countries.

Information in this document supersedes and replaces all information previously supplied.

The ST logo is a registered trademark of STMicroelectronics. All other names are the property of their respective owners.

© 2012 STMicroelectronics - All rights reserved

STMicroelectronics group of companies

Australia - Belgium - Brazil - Canada - China - Czech Republic - Finland - France - Germany - Hong Kong - India - Israel - Italy - Japan - Malaysia - Malta - Morocco - Philippines - Singapore - Spain - Sweden - Switzerland - United Kingdom - United States of America

www.st.com