

# ICE-100B Emulator User Guide

Revision 1.0, September 2009

Part Number  
82-000225-01

Analog Devices, Inc.  
One Technology Way  
Norwood, Mass. 02062-9106



## Copyright Information

©2009 Analog Devices, Inc., ALL RIGHTS RESERVED. This document may not be reproduced in any form without prior, express written consent from Analog Devices, Inc.

## Notice

Analog Devices, Inc. reserves the right to make changes to or to discontinue any product or service identified in this publication without notice.

Analog Devices assumes no liability for Analog Devices applications assistance, customer product design, customer software performance, or infringement of patents or services described herein. In addition, Analog Devices shall not be held liable for special, collateral, incidental or consequential damages in connection with or arising out of the furnishing, performance, or use of this product.

Analog Devices products are not intended for use in life-support applications, devices, or systems. Use of an Analog Devices product in such applications without the written consent of the appropriate Analog Devices officer is prohibited.

Users are restricted from copying, modifying, distributing, reverse engineering and reverse assembling or reverse compiling the Analog Devices emulator operational software (one copy may be made for back-up purposes only).

## Trademark and Service Mark Notice

The Analog Devices logo, VisualDSP++, Blackfin, TigerSHARC, SHARC, the CROSSCORE logo, EZ-KIT Lite, and EZ-ICE are registered trademarks or registered trademarks of Analog Devices, Inc.

All other brand and product names are trademarks or service marks of their respective owners.

## Regulatory Compliance

ICE-100B emulators are designed to be used solely in a laboratory environment. The emulator is not intended to be used in any end products or as a portion of an end product. The emulators may cause interference to other electronic devices operating at close proximity. The emulators should not be used in or near any medical equipment or RF devices.

The ICE-100B emulators have been certified to comply with the essential requirements of the European EMC directive 89/336/EEC (inclusive 93/68/EEC) and, therefore, carries the “CE” mark.



The ICE-100B emulators have been appended to Analog Devices Development Tools Technical Construction File referenced “DSPTOOLS1” dated December 21, 1997 and was awarded CE Certification by an appointed European Competent Body and is on file.

The ICE-100B emulator contains ESD (electrostatic discharge) sensitive devices. Electrostatic charges readily accumulate on the human body and equipment and can discharge without detection. Permanent damage may occur on devices subjected to high-energy discharges. Proper ESD precautions are recommended to avoid performance degradation or loss of functionality. Store unused ICE-100B emulators in the protective shipping package.





# CONTENTS

## PREFACE

Purpose of This Manual .....	viii
Intended Audience .....	viii
Manual Contents .....	viii
Technical and Customer Support .....	ix

## GETTING STARTED

Contents of Emulator Package .....	1-2
PC Configuration .....	1-2
USB Installation Tasks .....	1-2
Verifying Driver Installation .....	1-4
Attaching to the Emulation Target .....	1-6
VisualDSP++ Configurator .....	1-8
JTAG Frequency .....	1-8
Troubleshooting and Warranty Information .....	1-9

## HARDWARE DESCRIPTION

LEDs .....	2-1
Resetting the Target .....	2-2
To Reset the Target .....	2-3

Designing Custom Processor Boards ..... 2-4  
Mechanical Specifications ..... 2-4

## **SUPPORT**

Technical Support ..... 3-1  
Quality Assurance ..... 3-2

## **REFERENCES**

## **INDEX**

# PREFACE

Thank you for purchasing the ICE-100B Emulator. The ICE-100B emulator is used in conjunction with the VisualDSP++<sup>®</sup> development environment to create, test, and debug advanced processor application software on Analog Devices Blackfin<sup>®</sup> processors.

The ICE-100B emulator provides state-of-the-art support for JTAG-compliant Analog Devices processors. Key features of the ICE-100B emulator include:

- Plug-n-Play, USB 2.0 compliant
- High-speed USB device
- USB bus-powered device
- Windows<sup>®</sup> XP or Windows Vista operation
- Multiple processor I/O voltage support
  - ✓ 1.8V, 2.5V, and 3.3V compliance
- Multiprocessor support
- JTAG clock operation of 5 MHz

Analog Devices carries a wide range of in-circuit emulation products. To learn more about Analog Devices emulators, go to:

<http://www.analog.com/processors/>

## Purpose of This Manual

# Purpose of This Manual

The *ICE-100B Emulator User Guide* provides directions for installing the ICE-100B hardware and software on your PC. The manual also describes how to configure and use the components of the ICE-100B emulators.

## Intended Audience

This manual is intended to help the customer understand the features and operation of the ICE-100B emulator so they can begin using VisualDSP++.

## Manual Contents

The manual consists of:

- Chapter 1, “[Getting Started](#)” on page 1-1  
Provides software and hardware installation procedures, PC system requirements, and basic board information.
- Chapter 2, “[Hardware Description](#)” on page 2-1  
Provides information on hardware aspects of the ICE-100B emulator.
- Chapter 3, “[Support](#)” on page 3-1  
Provides technical support contact information.
- Chapter 4, “[References](#)” on page 4-1  
Provides information on different resources available in developing an application based on an Analog Devices processor.



# Technical and Customer Support

You can reach Analog Devices, Inc. Customer Support in the following ways:

- Visit the Embedded Processing and DSP products Web site at [http://www.analog.com/processors/technical\\_support](http://www.analog.com/processors/technical_support)
- E-mail tools questions to [processor\\_tools.support@analog.com](mailto:processor_tools.support@analog.com)
- E-mail processor questions to [processor.support@analog.com](mailto:processor.support@analog.com) (World wide support)  
[processor.europe@analog.com](mailto:processor.europe@analog.com) (Europe support)  
[processor.china@analog.com](mailto:processor.china@analog.com) (China support)
- Phone questions to **1-800-ANALOGD**
- Contact your Analog Devices, Inc. local sales office or authorized distributor
- Send questions by mail to:  
Analog Devices, Inc.  
One Technology Way  
P. O. Box 9106  
Norwood, MA 02062-9106  
USA

## Technical and Customer Support

# 1 GETTING STARTED

This chapter provides the information needed to begin using Analog Devices ICE-100B emulators.

 Analog Devices emulators are not intended to be used in a production environment.

This chapter includes the following sections.

- [“Contents of Emulator Package” on page 1-2](#)  
Provides a list of the components that are shipped.
- [“PC Configuration” on page 1-2](#)  
Describes the minimal PC requirements.
- [“USB Installation Tasks” on page 1-2](#)  
Provides a step-by-step procedure for setting up the emulator hardware.
- [“Attaching to the Emulation Target” on page 1-6](#)  
Describes how to connect ICE-100B emulators to your target board.
- [“VisualDSP++ Configurator” on page 1-8](#)  
Describes how to specify a platform definition.
- [“JTAG Frequency” on page 1-8](#)  
Describes how to change the JTAG frequency.
- [“Troubleshooting and Warranty Information” on page 1-9](#)  
Describes other resources.

# Contents of Emulator Package

The ICE-100B emulator package contains the following items:

- ICE-100B emulator
- 2-meter USB Standard-A to mini-B cable

## PC Configuration

For correct operation of the ICE-100B emulator, your computer must have the minimal configuration:

- Windows XP or Windows Vista
- VisualDSP++ 5.0 Update 7 (or higher)

## USB Installation Tasks

Perform the following tasks to safely install your ICE-100B emulator. Follow these instructions in the presented order to ensure correct operation of your software and hardware.

1. Install VisualDSP++ 5.0 Update 7 (or higher). VisualDSP++ includes the USB driver needed for the ICE-100B emulator hardware. VisualDSP++ can be installed on Windows XP or Windows Vista. Refer to the *Installation Quick Reference Card* for details.

**Note:** If you connect the ICE first, before installing VisualDSP++, the Windows driver wizard will not be able to find the drivers to install for the emulator to function.

2. Select the operating voltage of the target DSP JTAG interface. The ICE-100B emulator ships with a jumper on positions 1 and 3, and 2 and 4, by default.

Refer to [Table 1-1](#) and [Figure 1-1](#).

Table 1-1. Specifying the Operating Voltage

Target Voltage	JP1 Settings (Installed Jumpers)
3.3 volts	1 and 3, 2 and 4
2.5 volts	1 and 2, 3 and 4
1.8 volts	3 and 5, 2 and 4

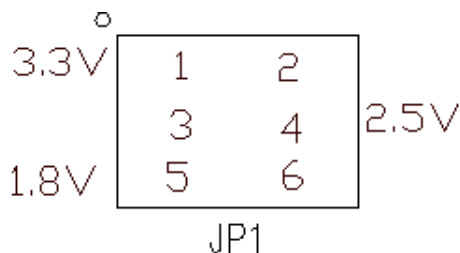

Figure 1-1. JP1 Pinout

3. Ensure that JP2 does not have a jumper across the pins for Windows mode. Refer to [Table 1-2](#). There may be a jumper hanging off one pin; this will not impact operation.

## USB Installation Tasks

Table 1-2. JP2 Settings

Jumper	Operating System
Uninstalled	Windows
Installed	Linux

4. Connect the USB cable between the ICE-100B emulator and a USB port of your computer.
5. Verify driver installation. Refer to [“Verifying Driver Installation” on page 1-4](#).

 Before connecting to a target, see the power-up/down procedures in [“Attaching to the Emulation Target” on page 1-6](#).

### Verifying Driver Installation

Before using the ICE-100B emulator, verify that the driver software is installed properly.

Open the Windows **Device Manager** and verify that the ICE-100B emulator appears under **ADI Development Tools**, as shown in [Figure 1-2](#)

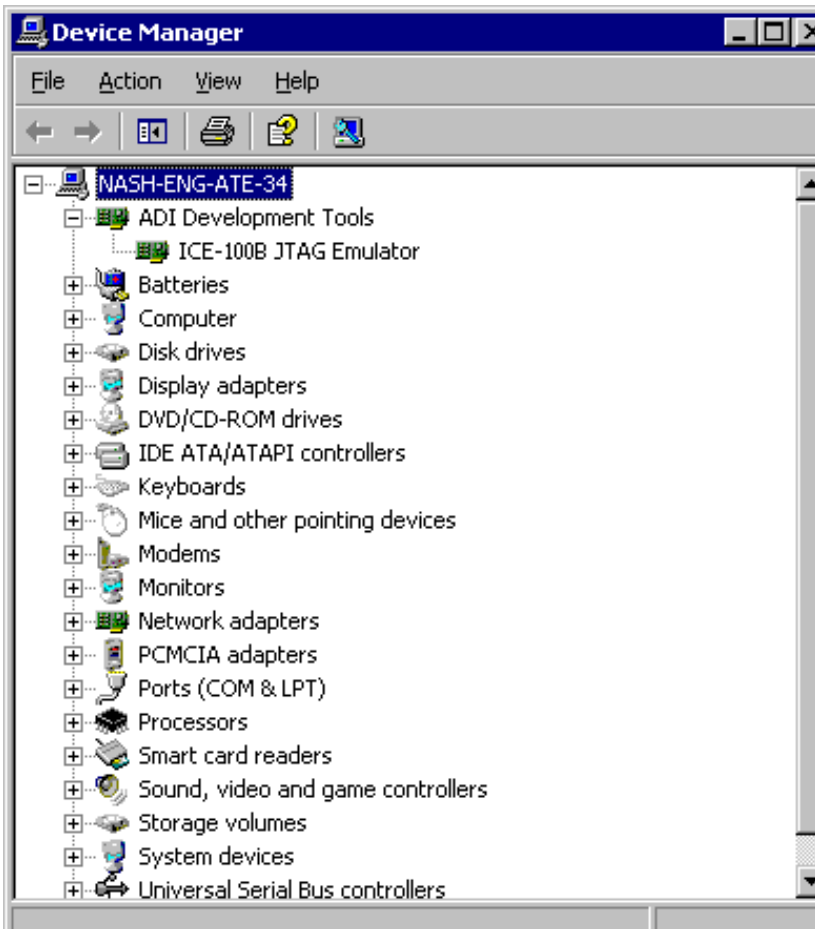

Figure 1-2. Verifying Driver Installation

# Attaching to the Emulation Target

The final step is to connect the 14-pin header (J1) of the ICE-100B emulator to the target board via the JTAG interface. The 14-pin connector is keyed at pin 3 on the emulator connector to ensure that the signals mate correctly with the 14-pin target emulation header. The target board should also have pin 3 of the JTAG interface connector cut. Refer to [Figure 1-3](#) for J1 pinout information.

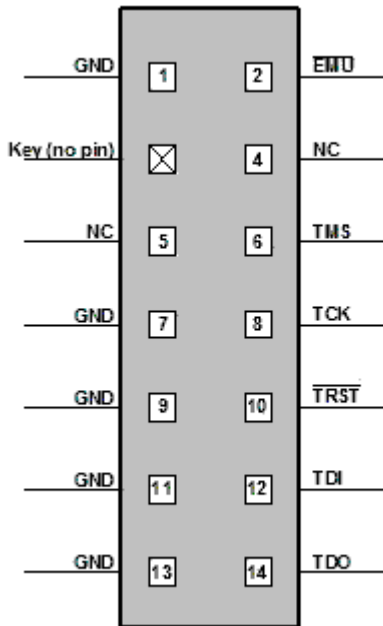

Figure 1-3. J1 Pinout



### Powering Up/Down the ICE-100B Emulator

To power up the ICE-100B emulator:

1. Apply power to the target board.
2. Connect the USB port on the computer to the ICE-100B emulator.

The ICE-100B is a bus-powered device, so this step powers the emulator.

3. Connect the ICE-100B emulator JTAG connector to the target JTAG header.
4. Invoke VisualDSP++.

To power down the ICE-100B emulator:

1. Shut down (exit) VisualDSP++.
2. Disconnect the USB cable between the ICE-100B emulator and the PC.
3. Power down the target board.



The “PWR” LED (power LED) should be green when power is applied and the board is not in hibernate state.

4. The ICE-100B emulator can now be removed from the target.

For custom processor boards still in design, refer to Engineer-to-Engineer Note, *Analog Devices JTAG Emulation Technical Reference (EE-68)*, available from the Analog Devices Web site. This document is a technical reference for implementing the JTAG interface on your target.

The emulator hardware is ready to be used in conjunction with VisualDSP++ to debug a processor target system.

# VisualDSP++ Configurator

VisualDSP++ requires a description of the *platform* (JTAG chain). The platform definition is necessary for VisualDSP++ to communicate with the hardware through the emulator.

The VisualDSP++ Configurator and ICE Test utilities allow configuration and testing of the emulator hardware. ICE Test provides emulator detection and JTAG interface testing. Use the ICE Test to test the target. If errors are encountered, they are reported immediately and the test ends. Refer to VisualDSP++ online Help for information about the VisualDSP++ Configurator and the ICE Test utility

## JTAG Frequency

The ICE-100B emulator supports JTAG clock operation at 5 MHz. There is a relationship between the JTAG frequency and the core clock frequency of the processor. The core clock should be at least twice the JTAG frequency in order for the JTAG interface to operate properly. On newer Analog Devices processors, the core clock is a variable that is sometimes set by switches or by software.

-  If the core/JTAG clock relation is not followed, scan failures may prevent the emulator from connecting to the processor.

## Troubleshooting and Warranty Information

To provide comprehensive troubleshooting advice and warranty information for all emulator and EZ-KIT Lite products, Analog Devices maintains an Engineer-to-Engineer Note to provide this information. *Emulator and EZ-KIT Lite Evaluation System Troubleshooting Guide (EE-175)*, is available online at: <http://www.analog.com>

This EE-Note can be used to resolve most installation, connection, and software issues affecting the use of Analog Devices in-circuit emulators (ICEs) and EZ-KIT Lite evaluation systems, avoiding the need to return the suspected faulty emulator or EZ-KIT Lite board. Please carry out all troubleshooting steps outlined in this document before contacting Analog Devices Processor Tools Support.

Also included in this EE-Note, you will find complete warranty and return material authorization (RMA) information for emulators and EZ-KIT Lite products. In general, emulators less than one year old are within warranty, and repairs within that period are free of charge, but there are some limitations to this warranty coverage. For details, see the EE-Note.

## Troubleshooting and Warranty Information

# 2 HARDWARE DESCRIPTION

This chapter describes the hardware design of the ICE-100B emulator and includes the following sections:

- [“LEDs” on page 2-1](#)  
Describes LEDs which inform you of the emulator’s status.
- [“Resetting the Target” on page 2-2](#)  
Describes how to reset the target.
- [“Designing Custom Processor Boards” on page 2-4](#)  
Describes concerns regarding board lay out.
- [“Mechanical Specifications” on page 2-4](#)  
Provides dimensional information.

## LEDs

Three LEDs are located on the ICE-100B emulator (refer to [Figure 2-1](#)):

- PWR LED - The Power LED signifies that the ICE is powered.
- MON LED - The Monitor LED signifies that the ICE is configured over USB.
- STAT LED - The Status LED signifies that the ICE is ignoring the EMU signal.

## Resetting the Target

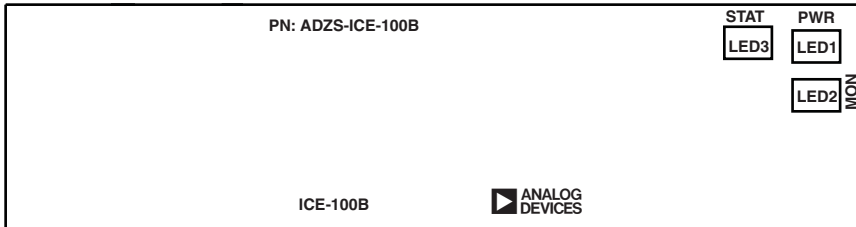

Figure 2-1. LED Positions - Top of Emulator Board

## Resetting the Target

When debugging remotely, the ability to reset the target can be very useful. Enable this function through the **Reset Target Options** dialog box and by soldering a wire from the ICE-100B emulator to the target. Two solder points labeled “RESET” (reference designator P3) are located near the JTAG connector (J1) and the USB connector (P1) on the ICE-100B.

For an active low version ( $\sim$ RESET), solder a wire between the square pad (pin 1) of P3 and the  $\sim$ RESET input signal of the target.

For an active high version (RESET), solder a wire between the round pad (pin 2) and the RESET input signal of the target

**i** If the **Enabled** option of the **Reset Target Options** dialog box is not selected (checked), the **Reset Target** command under the **Debug** menu item will be grayed out.

## To Reset the Target

- From the **Debug** menu, choose **Reset Target**.

This sends a reset pulse of the specified **Reset Time** duration to the target.

### Reset Target Options Dialog Box

Use the **Reset Target Options** dialog box (refer to [Figure 2-2](#) and [Table 2-1](#)) to enable/disable the target reset function and to specify the duration of the reset target pulse.



Figure 2-2. Reset Target Options Dialog Box

Table 2-1. Fields on the Reset Target Options Dialog Box

Field or Button	Description
Reset Time	Indicates the duration in milliseconds of the reset pulse that is to be sent to the target
Reset Function	When <b>Enabled</b> is selected (checked), allows the target to be reset. If this check box is not checked, the <b>Reset Time</b> box will be grayed
OK	Exits and saves changes
Cancel	Exits and discards changes

# Designing Custom Processor Boards

When designing a custom processor board using Analog Devices processors and DSPs, special care must be taken to ensure that the JTAG interface is designed and laid out correctly. If the board is not designed correctly, communication via the JTAG port may not work. Another side effect may be that the interface works, but you are not able to run at the highest possible JTAG clock frequency. The JTAG clock frequency is dependant on the particular Analog Devices processor, as well as the delay characteristics of the custom processor board.

To ensure that the custom board's JTAG interface is designed and laid out correctly, refer to Engineer-to-Engineer Note, *Analog Devices JTAG Emulation Technical Reference (EE-68)*, available from the Analog Devices Web site. This document is a technical reference for implementing the JTAG interface on your target.

## Mechanical Specifications

The outer dimensions of the ICE-100B emulator are 2.99" x 0.785". The height of the JTAG connector (J1) is approximately 0.310". The tallest component on the top is 0.235", and the tallest component on the bottom is 0.045". Refer to [Figure 2-3](#).

Care must be taken when locating a custom target JTAG interface connector, that no components are taller than about 0.15" if located under the emulator.



If there are any concerns that emulator components may short to the target board, an insulator should be used to provide protection.



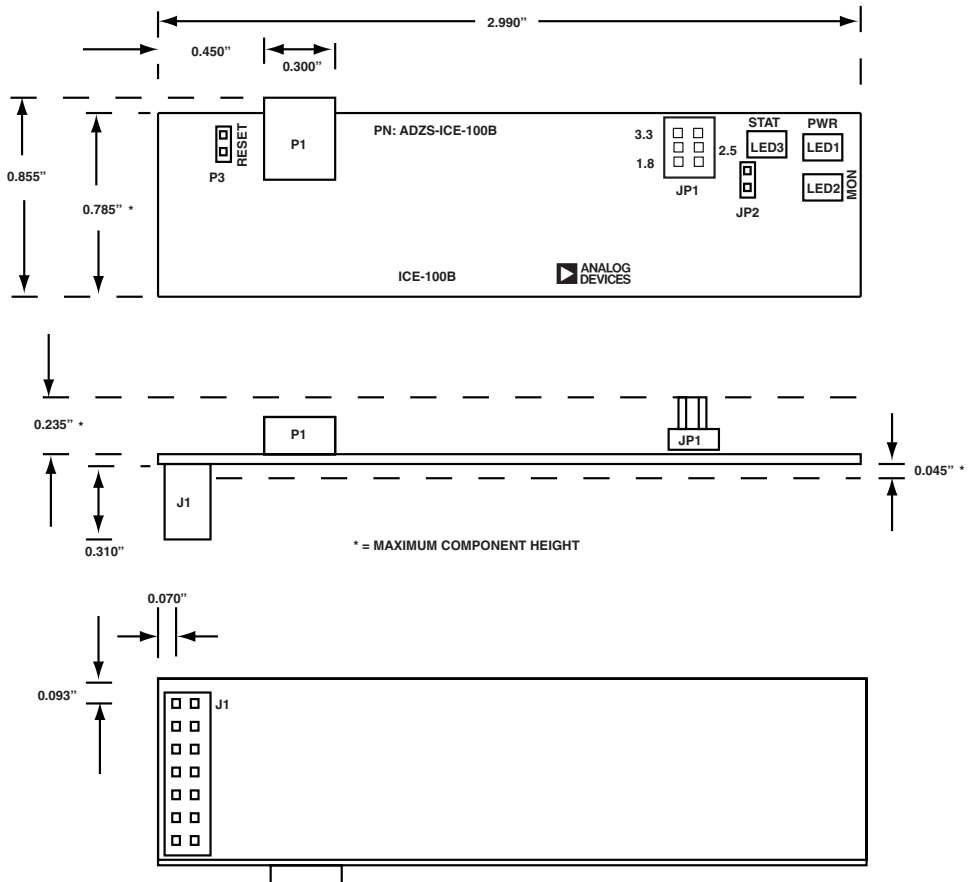

Figure 2-3. ICE-100B Emulator Dimensions (in inches)

# Mechanical Specifications

# 3 SUPPORT

Analog Devices provides free technical support.

## Technical Support

For technical support, visit the Embedded Processing and DSP Technical Support page at:

[http://www.analog.com/processors/technical\\_support](http://www.analog.com/processors/technical_support)

From there you can:

- Access the EngineerZone DSP Support Forum where Analog Devices support team members and other designers exchange ideas and answer questions
- Search our vast Knowledge Base containing application notes, data sheets, code examples, manuals, and more
- Contact our Technical Support team directly by filling out the support form

Alternately, you can contact Technical Support directly as follows:

- For tools issues, send a description of the problem by e-mail to [processor.tools.support@analog.com](mailto:processor.tools.support@analog.com)
- For processor issues, send a description of the problem by e-mail to the Application Engineering group at [processor.support@analog.com](mailto:processor.support@analog.com)

# Quality Assurance

Analog Devices is committed to providing quality products and services. To continually provide this quality, please contact our Quality Assurance Department directly if you have any concerns at (603) 883-2430, Monday through Friday during normal business hours, or via e-mail at: [processor\\_tools\\_support@analog.com](mailto:processor_tools_support@analog.com). Our Quality Assurance manager will listen to your concerns and provide a timely and effective solution.

# 4 REFERENCES

This section describes documentation resources helpful in your application development.

- For information on designing the interface between an Analog Devices processor and the emulation header on your custom processor target board, refer to Engineer-to-Engineer Note, *Analog Devices JTAG Emulation Technical Reference (EE-68)*, available from the Analog Devices Web site.
- For information on the architecture and system interface of the Analog Devices processor, refer to the appropriate Analog Devices processor's *Hardware Reference*.
- For processor timing specification and other hardware design information, refer to the appropriate processor's *Data Sheet*.
- For complete information on software development tools (assembler, compiler, linker, and so on), refer to documentation included with VisualDSP++. This information is available in PDF format and in VisualDSP++ online Help.
- For information about your development platform, refer to your operating system manuals and hardware system manuals.

- For information about digital signal processing theory and applications, consult:
  - ✓ Higgins. *Digital Signal Processing In VLSI*. Prentice-Hall, 1990.
  - ✓ Oppenheim and Schafer. *Digital Signal Processing*. Prentice-Hall, 1975.

# I INDEX

## A

attaching JTAG cable, [1-6](#)

## C

contents, emulator package, [1-2](#)  
customer support, [-ix](#)  
custom processor boards, [2-4](#)

## D

data sheets, [4-1](#)  
designing custom boards, [2-4](#)  
Device Manager window, [1-4](#)  
digital signal processing theory, [4-2](#)  
documentation resources, [4-1](#)  
drivers, [1-4](#)

## E

EE-175, [1-9](#)  
EE-68, [1-7](#), [2-4](#), [4-1](#)  
emulators  
    ICE-100B, [1-1](#)  
    troubleshooting, [1-9](#)

## F

frequency, [2-4](#)

## H

hardware  
    description, [2-1](#)  
    references, [4-1](#)  
high-speed USB device, [-vii](#)

## I

ICE-100B emulator, about, [1-1](#)  
ICE Test, [1-8](#)  
installation tasks, [1-2](#)  
I/O voltage, [-vii](#)

## J

JTAG  
    clock frequency, [2-4](#)  
    frequency, [1-8](#)  
    header, [2-4](#)  
    port, [2-4](#)

## L

Linux operation, [1-3](#)

## M

mechanical specifications, [2-4](#)  
multiprocessor support, [-vii](#)

## P

PC configuration, [1-2](#)

## Q

quality assurance, [3-2](#)

## R

resetting the target, [2-2](#)

## T

target, resetting, [2-2](#)

technical support, [3-1](#)

## V

verifying driver installation, [1-4](#)

VisualDSP++, [-vii](#), [1-2](#)

documentation, [4-1](#)

VisualDSP++ Configurator, [1-8](#)

## W

Windows operation, [1-3](#)