

BUNDLING AND SECURING SOLUTIONS

- Materials Information 6-9
- Cable Ties 10-54
- Grip Ties 55-57
- Cable Tie Mounts 58-65
- Cable Tie Tools 66-80

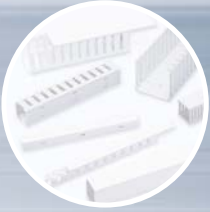

Optimum storage conditions for cable ties made of polyamide (PA)

HellermannTyton cable ties and mounts are manufactured from high-quality polyamide (PA). This material is mainly processed using injection molding, but can also be extruded.

Polyamide is a hygroscopic material. This means that the material absorbs and loses moisture. For optimum handling of cable ties, it is important that the material is in a condition of equilibrium with a water content of approximately 2.5%.

The packaging used by HellermannTyton ensures that the water content in the material remains constant. Therefore, it is important to store the products in their original packaging to preserve the quality of the ties and mounts.

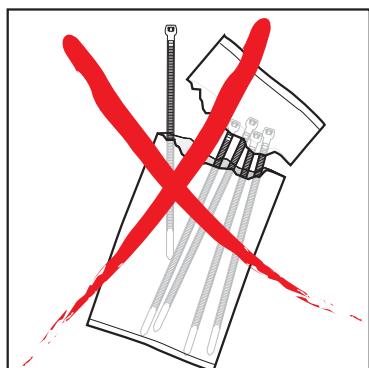

Once opened you should use the ties as quickly as possible.



Do not expose the product to direct sunlight

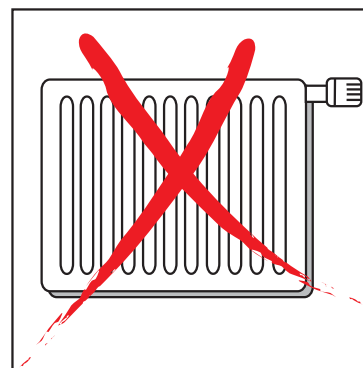

Store the product away from direct sources of heat

Ideal storage conditions:

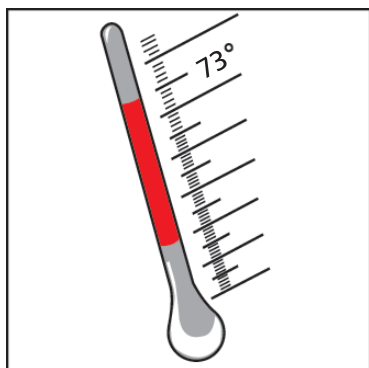

73 °F

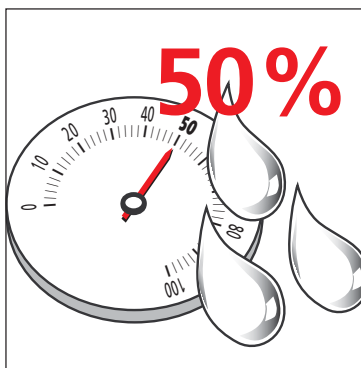

50% relative humidity

Cable Ties and Tool Systems

HellermannTyton's cable tie and tool systems are designed to work together to provide optimal consistency, quality, safety, and overall performance. Wrapping and hand tensioning a high quality cable tie is just the first step in assuring a high quality application. It is necessary to use one of HellermannTyton's cable tie tools to ensure that the cable tie is applied with just the right amount of tension and with a flush cut that won't leave a sharp edge. HellermannTyton leads the world in the development and manufacture of ergonomically designed, high performing cable tie tools in mechanical, power assisted, and automatic versions. With HellermannTyton's automatic cable tie systems, cable ties are applied, tensioned and cut-off to the correct tension in approximately one second. HellermannTyton's mechanical and power assisted tools expertly tension and cut-off hand applied cable ties.

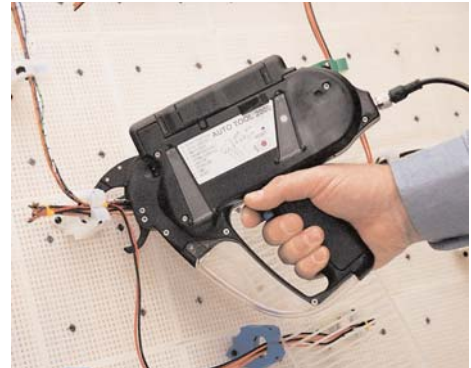

AT2000 Automatic Cable Tie Tool — For automatic cable tie tool systems, see page 72.

Consistency and Quality

By utilizing HellermannTyton's cable ties and tools together, a consistent tension and cut-off is achieved. When using non-approved methods of cutting off a cable tie, wire and cable can be crushed, the strap of the cable tie may be cut-off too deeply causing the tie to disengage, or the cable tie can be applied too loosely which can affect the bundling and securing properties of the application.

Safety

A flush cut is another benefit of using HellermannTyton's cable tie tools and ties as a system. Worker safety, and resulting reduction of workers' compensation claims, is an increasing priority of most companies. HellermannTyton's cable tie tools are ergonomically designed to reduce worker effort and causes of repetitive motion injuries. When using HellermannTyton's tools and cable ties, a flush cut is achieved, creating a smooth edge. When non-approved methods of applying a cable tie are used, a sharp edge is almost always left at the end of the tie - causing injury to workers and end-customers. All of HellermannTyton's cable tie tool systems offer adjustable tension and cut-off levels to assure optimal tensions and flush cut-offs.

Overall Performance

Used together, HellermannTyton's cable ties and ergonomically designed tool systems assure a high quality installation which prevents damage to wire and cable and potential rework due to inappropriately applied cable ties - all lowering installed costs while improving performance.



MK7P - Power Assisted Cable Tie Tool — For power assisted cable tie tools, see page 69.



MK7 and MK9 Mechanical Cable Tie Tools — For mechanical cable tie tools, see page 66.

Materials

HellermannTyton has worked very closely with its material suppliers to develop resins that are specifically formulated for fastener and cable tie production. HellermannTyton has spearheaded material advancements in component manufacturing to assure its customers of the finest quality products. Environmental factors can have an adverse effect on fasteners. It is very important to use the most suitable material for each application. HellermannTyton fasteners are available in a variety of materials ranging from polyamides (nylon) to fluoropolymers.

Polyamide 6.6 – General Purpose



General purpose polyamide 6.6 features light weight, high strength and a wide temperature range. Polyamide 6.6 is hygroscopic, and therefore, absorbs or releases moisture depending on its environment. Thus, the moisture level of the material will affect tensile strength, stiffness and elongation of the product.

Polyamide 6.6 – Heat Stabilized



With similar properties and benefits as polyamide 6.6, products manufactured with heat stabilized polyamide 6.6 material have a chemical stabilizer added for higher continuous temperature applications.

Polyamide 6.6 – UV Resistant



Chemical inhibitors are used to give polyamide 6.6 material added properties to fight against premature aging of products due to the effects of ultraviolet rays.

Polyamide 6.6 – UV Resistant (2% Carbon for Military Specification)



The physical properties of this material include carbon, which acts as a UV stabilizer, prolonging the life of the product under ultraviolet conditions. It also allows HellermannTyton's black cable ties to meet the particular military specification for cable ties.

Polyamide 6.6 – V0 Flame Retardant



This material meets UL 94V-0 flammability requirements. Flame retardant additives generally reduce tensile strength when compared to general purpose polyamide 6.6, but this resin has been formulated to minimize such effects.

Polyamide 6.6 – Impact Modified, Heat Stabilized and UV Resistant



Impact modified polyamide 6.6 offers the increased flexibility, heat resistance and UV resistance of the high impact material with the added feature of greater resistance to vibration, heat and sunlight for mobile applications.

Polyamide 6.6 – High Impact



Impact modifiers are added to increase flexibility. High impact polyamide 6.6 has stable tensile strength due to its reduced influence from moisture. It is excellent for high vibration applications, as within the aircraft and automobile industries and performs better than polyamide 6.6 against ultraviolet rays. Good for outdoor use.

Polyamide 4.6



Polyamide 4.6, like polyamide 6.6, offers light weight and high strength benefits, but offers an even wider temperature range. This material can be used at a higher continuous operating temperature than polyamide 6.6 - heat stabilized. In addition to having excellent heat resistance, polyamide 4.6 has low creep effects and retention of stiffness at elevated temperatures.

Polypropylene



Polypropylene is used in environments where chemical effects on polyamide are a concern. It is not affected by inorganic acids (hydrochloric), polyhydric alcohols (ethyleneglycol), neutral salts (sodium chloride) and basic salts (sodium bicarbonate). Polypropylene also resists a number of other chemicals with good results, although it has lower tensile strength than polyamide 6.6 (about half). Polypropylene has good UV resistance.

Polyamide 12



Although not as strong as polyamide 6.6 (about half), polyamide 12 is extremely flexible, absorbs little moisture, ages better and has better chemical and UV resistance than general purpose polyamide 6.6. Polyamide 12 is good for applications where products are exposed to metal oxides.

Ethylentetrafluorethylene - Tefzel



Although about two-thirds the strength of polyamide 6.6, Tefzel is resistant to a wide range of chemicals, such as concentrated hydrofluoric and sulfuric acids. It is also a low water absorbing material, therefore, is not adversely affected by water. Tefzel is radiation resistant up to 200 megarads and meets the fire and smoke requirements of IEEE 383. Tefzel also withstands high temperatures and ultraviolet light exposure. Products made from Tefzel material also have non-outgassing properties for zero gravity applications.

Polyacetal



Polyacetal has excellent dielectric properties, UV and chemical resistance, and a UL94-HB flame rating. It has been tested for excellent weatherability against moisture, sunlight, and other environmental conditions.

Halar



Halar is similar to Tefzel in performance and benefits. Halar is recognized for its low smoke density attribute when burned. This makes products made out of Halar more desirable for use in areas where smoke generation is a concern, as when bundling wire and cable in air handling spaces. * Halar is a registered trademark of Solvay S.A.

For more information on RoHS/WEEE Compliance, go online to: <http://www.hellermann.tyton.com/rohs.asp>

Material Specifications

MATERIAL	CONTINUOUS OPERATING TEMPERATURE		TENSILE STRENGTH AT 73°F DRY AS MOLDED ASTM D-638 (PSI)	UL FLAME RATING	OXYGEN INDEX %	GAMMA RADIATION RESISTANCE	UV RESISTANCE	MILITARY, FEDERAL, ASTM AND FDA SPECIFICATIONS
	MAX.	MIN.						
Polyamide 6.6-General Purpose (PA66)	185°F 85°C	-40°F -40°C	12,000	94V-2	28	1 x 10 ⁵ Rads	Poor	ASTM D-4066PA0111 FDA CFR177.1500
Polyamide 6.6-Heat Stabilized (PA66HS)	221°F 105°C	-40°F -40°C	12,000	94V-2	26	1 x 10 ⁵ Rads	Poor	ASTM D-4066PA0121
Polyamide 6.6-UV resistant (PA66UV)	185°F 85°C	-40°F -40°C	12,000	94V-2	26	1 x 10 ⁵ Rads	Good	-
Polyamide 6.6-2% Carbon UV resistant	185°F 85°C	-40°F -40°C	12,000	94V-2	26	1 x 10 ⁵ Rads	Good	ASTM D-4066PA0181 MS3367/8
Polyamide 6.6-Flame Retardant (PA66VO)	185°F 85°C	-40°F -40°C	10,800	94V-0	34	1 x 10 ⁵ Rads	Poor	ASTM D-4066PA0110
Polyamide 6.6-Impact Mod. Heat Stabilized, UV Resistant (PA66HIRHS)	230°F 110°C	-40°F -40°C	9,500	94-HB	N/A	N/A	Very Good	ASTM D-4066PA0161
Polyamide 6.6-High Impact (PA66HIR)	230°F 110°C	-40°F -40°C	8,800	94-HB	19	1 x 10 ⁵ Rads	Good	ASTM D-4066PA0151
Polyamide 4.6- Heat Stabilized (PA46)	275°F 135°C	-40°F -40°C	14,400	94V-2	27	9 x 10 ⁶ Rads	Poor	ASTM D-4066PA0922
Polypropylene-Chemical Resistant (PP)	239°F 115°C	-40°F -40°C	3,400	94-HB	N/A	1 x 10 ⁵ Rads	Good	ASTM D-4101PP0327
Polyamide 12-UV resistant (UV)	176°F 80°C	-40°F -40°C	5,800	94-HB	N/A	1 x 10 ⁵ Rads	Good	ASTM D-4066PA411
Ethlenterafluorineethylene Tefzel® (E/TFE)	302°F 150°C	-112°F -80°C	5,800	94V-0	30	2 x 10 ⁸ Rads	Excellent	UL2043 ASTM D-3159 Type 1 Grade 1
Polyacetal (POM)	185°F 85°C	-40°F -40°C	6,500	94-HB	N/A	N/A	Excellent	-
Halar® (PA66HL)	300°F 150°C	-104°F -76°C	6,100	94V-0	52	2 x 10 ⁸ Rads	Excellent	ASTM D-3275 Type CFDA CFR177.1380

Material Performance Guide

ATTRIBUTE	POLYAMIDE 6.6 GENERAL PURPOSE	POLYAMIDE 6.6 HEAT STABILIZED	POLYAMIDE 6.6 UV RESISTANT	POLYAMIDE 6.6 - 2% CARBON UV RESISTANT	POLYAMIDE 6.6 FLAME RETARDANT VO	POLYAMIDE 6.6 IMPACT MODIFIED , HEAT STABILIZED UV RESISTANT	POLYAMIDE 6.6 HIGH IMPACT	POLYAMIDE 4.6 HEAT STABILIZED	POLYPROPYLENE	POLYAMIDE 12 UV RESISTANT	ETHLENTERAFLUORINE-ETHYLENE — TEFZEL®	POLYACETAL	HALAR®
Tensile Strength	8	8	8	9	7	8	7	10	2	4	5	5	5
High Temperature	2	3	2	2	2	3	2	9	2	1	10	3	10
Flammability	5	5	5	5	10	2	2	5	2	2	10	2	10
UV Resistance	1	1	5	8	1	8	2	1	5	3	10	10	10
Radiation	3	3	3	3	3	3	3	3	6	3	10	3	10
Chemical Resistance	6	6	6	6	6	6	6	6	8	8	10	-	10
- Hydrocarbons	8	8	8	8	8	8	8	8	6	8	10	8	10
- Chlorinated Hydrocarbons	6	6	6	6	6	6	6	6	3	8	10	5	5
- Acids	2	2	2	2	2	2	2	2	8	5	10	8	10
- Bases	8	6	6	6	6	6	6	6	8	6	10	8	10
- Salts	3	3	3	3	3	3	3	3	10	8	10	8	10
Relative Cost	Low	Low	Med.	Med.	Med.	Med.	Med.	Med.	Med.	Med.	High	Med.	High

10 = Most Recommended 1= Least Recommended

Cable Ties

Standard Cable Ties T18 - T30 Series - Natural and Black

Material Data	
Material	Polyamide 6.6 (PA66)
Operating Temperature	-40 °F to +185 °F (-40 °C to +85 °C) continuous
Flammability	UL94 V2

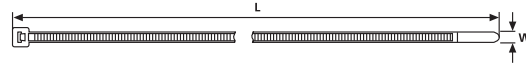

Product Selection													
Article No.	Part No.	Type	US Gov. Designation	Min. Tensile Strength		Length (L)		Max. Ø Bundle		Width (W)		Color	Pkg. Qty.
				lbs.	(N)	in.	(mm)	in.	(mm)	in.	(mm)		
T18S													
111-02805	T18S9C2	T18S	MS3367-4-9	18 lbs	(80)	3.27"	(83)	.63"	(16)	.09"	(2.3)	Natural	100
111-02809	T18S9M4	T18S	MS3367-4-9	18 lbs	(80)	3.27"	(83)	.63"	(16)	.09"	(2.3)		1000
111-02810	T18S0C2	T18S	*	18 lbs	(80)	3.27"	(83)	.63"	(16)	.09"	(2.3)	Black	100
111-02811	T18S0M4	T18S	*	18 lbs	(80)	3.27"	(83)	.63"	(16)	.09"	(2.3)		1000
T18R													
112-01819	T18R9C2	T18R	MS3367-4-9	18 lbs	(80)	4"	(100)	.87"	(22)	.10"	(2.5)	Natural	100
111-01872	T18R9M4	T18R	MS3367-4-9	18 lbs	(80)	4"	(100)	.87"	(22)	.10"	(2.5)		1000
111-00405	T18R0C2	T18R	*	18 lbs	(80)	4"	(100)	.87"	(22)	.10"	(2.5)	Black	100
111-01841	T18R0M4	T18R	*	18 lbs	(80)	4"	(100)	.87"	(22)	.10"	(2.5)		1000
T18I													
111-02311	T18I9C2	T18I	-	18 lbs	(80)	5.51"	(140)	1.38"	(35)	.10"	(2.5)	Natural	100
111-02322	T18I9M4	T18I	-	18 lbs	(80)	5.51"	(140)	1.38"	(35)	.10"	(2.5)		1000
111-02308	T18I0C2	T18I	-	18 lbs	(80)	5.51"	(140)	1.38"	(35)	.10"	(2.5)	Black	100
111-02315	T18I0M4	T18I	-	18 lbs	(80)	5.51"	(140)	1.38"	(35)	.10"	(2.5)		1000
T18L													
111-02189	T18L9C2	T18L	-	18 lbs	(80)	8.0"	(205)	2.17"	(55)	.10"	(2.5)	Natural	100
111-02026	T18L9M4	T18L	-	18 lbs	(80)	8.0"	(205)	2.17"	(55)	.10"	(2.5)		1000
111-00401	T18L0C2	T18L	-	18 lbs	(80)	8.0"	(205)	2.17"	(55)	.10"	(2.5)	Black	100
111-02015	T18L0M4	T18L	-	18 lbs	(80)	8.0"	(205)	2.17"	(55)	.10"	(2.5)		1000
T30R													
112-03019	T30R9C2	T30R	MS3367-5-9	30 lbs	(135)	5.9"	(150)	1.38"	(35)	.14"	(3.5)	Natural	100
111-03047	T30R9M4	T30R	MS3367-5-9	30 lbs	(135)	5.9"	(150)	1.38"	(35)	.14"	(3.5)		1000
111-00438	T30R0C2	T30R	*	30 lbs	(135)	5.9"	(150)	1.38"	(35)	.14"	(3.5)	Black	100
111-03034	T30R0M4	T30R	*	30 lbs	(135)	5.9"	(150)	1.38"	(35)	.14"	(3.5)		1000
T30L													
111-03325	T30L9C2	T30L	-	30 lbs	(135)	7.48"	(190)	1.97"	(50)	.14"	(3.5)	Natural	100
111-03327	T30L9M4	T30L	-	30 lbs	(135)	7.48"	(190)	1.97"	(50)	.14"	(3.5)		1000
111-03313	T30L0C2	T30L	-	30 lbs	(135)	7.48"	(190)	1.97"	(50)	.14"	(3.5)	Black	100
111-03315	T30L0M4	T30L	-	30 lbs	(135)	7.48"	(190)	1.97"	(50)	.14"	(3.5)		1000
T30LL													
111-03515	T30LL9C2	T30LL	-	30 lbs	(135)	11.42"	(290)	3.15"	(80)	.14"	(3.5)	Natural	100
111-03517	T30LL9M4	T30LL	-	30 lbs	(135)	11.42"	(290)	3.15"	(80)	.14"	(3.5)		1000
111-03501	T30LL0C2	T30LL	-	30 lbs	(135)	11.42"	(290)	3.15"	(80)	.14"	(3.5)	Black	100
111-03511	T30LL0M4	T30LL	-	30 lbs	(135)	11.42"	(290)	3.15"	(80)	.14"	(3.5)		1000
T30XL													
111-02900	T30XL9C2	T30XL	MS3367-5-9	30 lbs	(135)	14.37"	(365)	4.13"	(105)	.14"	(3.5)	Natural	100
111-02907	T30XL9M4	T30XL	MS3367-5-9	30 lbs	(135)	14.37"	(365)	4.13"	(105)	.14"	(3.5)		1000
111-02901	T30XL0C2	T30XL	*	30 lbs	(135)	14.37"	(365)	4.13"	(105)	.14"	(3.5)	Black	100
111-02903	T30XL0M4	T30XL	*	30 lbs	(135)	14.37"	(365)	4.13"	(105)	.14"	(3.5)		1000

Installation tools - MK7, MK7HT, MK7P, MK9, MK9HT, MK9P. MK9 and MK9P cannot be used with T18S cable ties.

Dimensions are approximate and subject to technical changes. Use **Part No.** for ordering and **Type** for specification purposes.

* Military black available. Contact HellermannTyton for more information.

Standard Cable Ties T40 - T50 Series - Natural and Black

Material Data	
Material	Polyamide 6.6 (PA66)
Operating Temperature	-40 °F to +185 °F (-40 °C to +85 °C) continuous
Flammability	UL94 V2

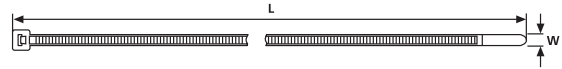

Product Selection													
Article No.	Part No.	Type	US Gov. Designation	Min. Tensile Strength		Length (L)		Max. Ø Bundle		Width (W)	Color	Pkg. Qty.	
				lbs.	(N)	in.	(mm)	in.	(mm)	in.			(mm)
T40R													
112-04019	T40R9C2	T40R(U)	–	40 lbs	(180)	8.27"	(210)	2.16"	(55)	.16"	(4.0)	Natural	100
111-04131	T40R9M4	T40R(U)	–	40 lbs	(180)	8.27"	(210)	2.16"	(55)	.16"	(4.0)		1000
112-04060	T40R0C2	T40R(U)	–	40 lbs	(180)	8.27"	(210)	2.16"	(55)	.16"	(4.0)	Black	100
111-04122	T40R0M4	T40R(U)	–	40 lbs	(180)	8.27"	(210)	2.16"	(55)	.16"	(4.0)		1000
T40I													
111-04609	T40I9C2	T40I	–	40 lbs	(180)	11.42"	(290)	3.15"	(80)	.16"	(4.0)	Natural	100
111-04612	T40I9M4	T40I	–	40 lbs	(180)	11.42"	(290)	3.15"	(80)	.16"	(4.0)		1000
111-04600	T40I0C2	T40I	–	40 lbs	(180)	11.42"	(290)	3.15"	(80)	.16"	(4.0)	Black	100
111-04604	T40I0M4	T40I	–	40 lbs	(180)	11.42"	(290)	3.15"	(80)	.16"	(4.0)		1000
T40L													
111-04300	T40L9C2	T40L	–	40 lbs	(180)	14.4"	(365)	4.13"	(105)	.16"	(4.0)	Natural	100
111-04311	T40L9M4	T40L	–	40 lbs	(180)	14.4"	(365)	4.13"	(105)	.16"	(4.0)		1000
111-04301	T40L0C2	T40L	–	40 lbs	(180)	14.4"	(365)	4.13"	(105)	.16"	(4.0)	Black	100
111-04305	T40L0M4	T40L	–	40 lbs	(180)	14.4"	(365)	4.13"	(105)	.16"	(4.0)		1000
T50S													
111-05811	T50S9C2	T50S	–	50 lbs	(225)	5.9"	(150)	1.38"	(35)	.18"	(4.6)	Natural	100
111-05813	T50S9M4	T50S	–	50 lbs	(225)	5.9"	(150)	1.38"	(35)	.18"	(4.6)		1000
111-05806	T50S0C2	T50S	–	50 lbs	(225)	5.9"	(150)	1.38"	(35)	.18"	(4.6)	Black	100
111-05808	T50S0M4	T50S	–	50 lbs	(225)	5.9"	(150)	1.38"	(35)	.18"	(4.6)		1000
T50R													
112-05019	T50R9C2	T50R	MS3367-1-9	50 lbs	(225)	7.9"	(200)	1.97"	(50)	.18"	(4.6)	Natural	100
111-04862	T50R9M4	T50R	MS3367-1-9	50 lbs	(225)	7.9"	(200)	1.97"	(50)	.18"	(4.6)		1000
111-04878	T50R0C2	T50R	*	50 lbs	(225)	7.9"	(200)	1.97"	(50)	.18"	(4.6)	Black	100
111-04846	T50R0M4	T50R	*	50 lbs	(225)	7.9"	(200)	1.97"	(50)	.18"	(4.6)		1000
T50I													
112-05219	T50I9C2	T50I	MS3367-7-9	50 lbs	(225)	11.8"	(300)	3.35"	(85)	.18"	(4.6)	Natural	100
111-05230	T50I9M4	T50I	MS3367-7-9	50 lbs	(225)	11.8"	(300)	3.35"	(85)	.18"	(4.6)		1000
111-00444	T50I0C2	T50I	*	50 lbs	(225)	11.8"	(300)	3.35"	(85)	.18"	(4.6)	Black	100
111-05216	T50I0M4	T50I	*	50 lbs	(225)	11.8"	(300)	3.35"	(85)	.18"	(4.6)		1000
T50L													
112-05419	T50L9C2	T50L	MS3367-2-9	50 lbs	(225)	15.35"	(390)	4.33"	(110)	.18"	(4.6)	Natural	100
111-05449	T50L9M4	T50L	MS3367-2-9	50 lbs	(225)	15.35"	(390)	4.33"	(110)	.18"	(4.6)		1000
111-00445	T50L0C2	T50L	*	50 lbs	(225)	15.35"	(390)	4.33"	(110)	.18"	(4.6)	Black	100
111-00504	T50L0M4	T50L	*	50 lbs	(225)	15.35"	(390)	4.33"	(110)	.18"	(4.6)		1000

Installation tools - MK7, MK7HT, MK7P, MK9, MK9HT, MK9P. Dimensions are approximate and subject to technical changes.

Use **Part No.** for ordering and **Type** for specification purposes.

* Military black available. Contact HellermannTyton for more information.

Cable Ties

Heavy Duty Cable Ties

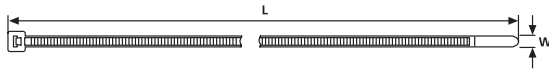

Material Data	
Material	Polyamide 6.6 (PA66)
Operating Temperature	-40 °F to +185 °F (-40 °C to +85 °C) continuous
Flammability	UL94 V2



T120 Series



Product Selection											
Article No.	Part No.	Type	US Gov. Designation	Min. Tensile Strength		Length (L)		Max. Ø Bundle	Width (W)	Color	Pkg. Qty.
				lbs. (N)	in. (mm)	in. (mm)	in. (mm)				
T120S											
111-12819	T120S9K2	T120S	-	120 lbs (535)	8.85" (225)	2.17" (55)	.30" (7.6)	Natural			50
111-12813	T120S9H4	T120S	-	120 lbs (535)	8.85" (225)	2.17" (55)	.30" (7.6)				500
111-12803	T120S0K2	T120S	-	120 lbs (535)	8.85" (225)	2.17" (55)	.30" (7.6)	Black			50
111-12808	T120S0H4	T120S	-	120 lbs (535)	8.85" (225)	2.17" (55)	.30" (7.6)				500
T120I											
111-12211	T120I9K2	T120I	-	120 lbs (535)	11.81" (300)	3.15" (80)	.30" (7.6)	Natural			50
111-12213	T120I9H4	T120I	-	120 lbs (535)	11.81" (300)	3.15" (80)	.30" (7.6)				500
111-12201	T120I0K2	T120I	-	120 lbs (535)	11.81" (300)	3.15" (80)	.30" (7.6)	Black			50
111-12206	T120I0H4	T120I	-	120 lbs (535)	11.81" (300)	3.15" (80)	.30" (7.6)				500
T120R											
112-12019	T120R9K2	T120R	MS3367-3-9	120 lbs (535)	15.24" (387)	4.13" (105)	.30" (7.6)	Natural			50
111-12036	T120R9H4	T120R	MS3367-3-9	120 lbs (535)	15.24" (387)	4.13" (105)	.30" (7.6)				500
112-12060	T120R0K2	T120R	*	120 lbs (535)	15.24" (390)	4.13" (105)	.30" (7.6)	Black			50
111-12013	T120R0H4	T120R	*	120 lbs (535)	15.24" (387)	4.13" (105)	.30" (7.6)				500
T120L											
111-12419	T120L9K2	T120L	MS3367-6-9	120 lbs (535)	30.0" (760)	8.85" (225)	.30" (7.6)	Natural			50
111-12405	T120L0K2	T120L	*	120 lbs (535)	30.0" (760)	8.85" (225)	.30" (7.6)	Black			50

Installation tools - MK9, MK9HT, MK9P. Dimensions are approximate and subject to technical changes. Use **Part No.** for ordering and **Type** for specification purposes. *Military black available. Contact HellermannTyton for more information.



T150 Series

Product Selection											
Article No.	Part No.	Type	US Gov. Designation	Min. Tensile Strength		Length (L)		Max. Ø Bundle	Width (W)	Color	Pkg. Qty.
				lbs. (N)	in. (mm)	in. (mm)	in. (mm)				
T150R											
111-15203	T150R9X2	T150R(U)	-	175 lbs (780)	15.35" (390)	4.13" (105)	.35" (8.8)	Natural			25
111-15200	T150R0X2	T150R(U)	-	175 lbs (780)	15.35" (390)	4.13" (105)	.35" (8.8)	Black			25
T150M											
111-15619	T150M9X2	T150M	-	175 lbs (780)	21.00" (530)	5.91" (150)	.35" (8.9)	Natural			25
111-00124	T150M0X2	T150M	-	175 lbs (780)	21.00" (530)	5.91" (150)	.35" (8.9)	Black			25
T150L											
111-15419	T150L9X2	T150L	-	175 lbs (780)	32.28" (820)	9.65" (245)	.35" (8.9)	Natural			25
111-15405	T150L0X2	T150L	-	175 lbs (780)	32.28" (820)	9.65" (245)	.35" (8.9)	Black			25
T150LL											
111-15719	T150LL9X2	T150LL	-	175 lbs (780)	36.42" (925)	10.83" (275)	.35" (8.9)	Natural			25
111-15700	T150LL0X2	T150LL	-	175 lbs (780)	36.42" (925)	10.83" (275)	.35" (8.9)	Black			25
T150XL											
111-15519	T150XL9X2	T150XL	-	175 lbs (780)	43.11" (1095)	13.00" (330)	.35" (8.9)	Natural			25
111-15500	T150XL0X2	T150XL	-	175 lbs (780)	43.11" (1095)	13.00" (330)	.35" (8.9)	Black			25
T150XLL											
111-15304	T150XLL9X2	T150XLL	-	175 lbs (780)	52.17" (1325)	15.95" (405)	.35" (8.9)	Natural			25
111-15300	T150XLL0X2	T150XLL	-	175 lbs (780)	52.17" (1325)	15.95" (405)	.35" (8.9)	Black			25

Installation tools - MK9, MK9HT, MK9P. Dimensions are approximate and subject to technical changes. Use **Part No.** for ordering and **Type** for specification purposes.

Wide Strap Heavy Duty Cable Ties

The wide strap cable tie minimizes pinching on soft bundles and features a low profile head to provide compact bundling. A thinner strap provides increased flexibility for improved ergonomics.

- Wide strap is designed to minimize pinching of soft hoses and convoluted tubing
- Low profile head
- Clamping rails on the bottom of head to increase grip on round bundles
- Accommodates a large range of bundle diameters: .375" - 4.125" (9.5mm - 104.7mm)
- Flexible strap
- Bent tip for quick insertion into mounts



Material Data

Material	Polyamide 6.6 high impact modified, heat stabilized (PA66HIRHS)
Operating Temperature	-40 °F to +230 °F (-40 °C to +110 °C) continuous
Flammability	UL94 HB

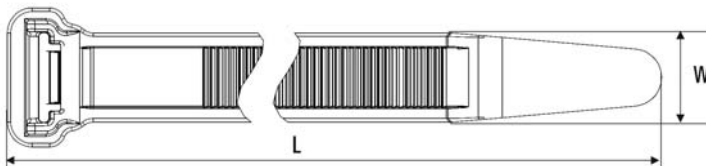

Product Selection

Article No.	Part No.	Type	Min. Tensile Strength		Length (L)		Max. Ø Bundle		Width (W)		Color	Pkg. Qty.
			lbs. (N)		in. (mm)		in. (mm)		in. (mm)			
WSS												
111-12303	111-12303	WSS	120 lbs (534)		9.1" (231.14)		2.25" (57.15)		.5" (12.7)		Black	60
111-12300	111-12300	WSS	120 lbs (534)		9.1" (231.14)		2.25" (57.15)		.5" (12.7)		Black	300
WSI												
111-12304	111-12304	WSI	120 lbs (534)		12.1" (307.34)		3.25" (82.55)		.5" (12.7)		Black	60
111-12301	111-12301	WSI	120 lbs (534)		12.1" (307.34)		3.25" (82.55)		.5" (12.7)		Black	300
WSR												
111-12305	111-12305	WSR	120 lbs (534)		15.1" (383.54)		4.125" (104.78)		.5" (12.7)		Black	60
111-12302	111-12302	WSR	120 lbs (534)		15.1" (383.54)		4.125" (104.78)		.5" (12.7)		Black	300

Installation tools - MK9, MK9HT, MK9P. Dimensions are approximate and subject to technical changes. Use **Part No.** for ordering and **Type** for specification purposes.

Cable Ties

Heavy Duty Cable Ties T250 Series

These cable ties offer a high minimum tensile strength and have a buckle feature which allows the end of the cable tie to be tucked away if necessary. The buckle also snaps into HellermannTyton LTM, lashing tie mounts.



T250 heavy duty cable tie and lashing tie mount application

Material Data	
Material	Polyamide 6.6 (PA66)
Operating Temperature	-40 °F to +185 °F (-40 °C to +85 °C) continuous
Flammability	UL94 V2

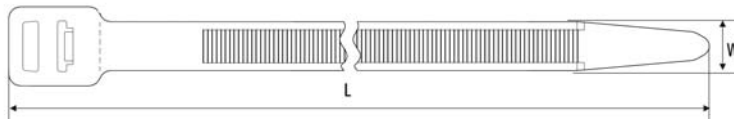

Product Selection												
Article No.	Part No.	Type	Min. Tensile Strength		Length (L)		Max. Ø Bundle		Width (W)		Color	Pkg. Qty.
			lbs.	(N)	in.	(mm)	in.	(mm)	in.	(mm)		
T250S												
111-24702	T250S9X2	T250S	250 lbs	(1115)	9.05"	(230)	2.17"	(55)	.49"	(12.5)	Natural	25
111-24700	T250S0X2	T250S	250 lbs	(1115)	9.05"	(230)	2.17"	(55)	.49"	(12.5)	Black	25
T250R												
111-24803	T250R9X2	T250R	250 lbs	(1115)	20.47"	(520)	5.71"	(145)	.49"	(12.5)	Natural	25
111-24801	T250R0X2	T250R	250 lbs	(1115)	20.47"	(520)	5.71"	(145)	.49"	(12.5)	Black	25
T250M												
111-25002	T250M9X2	T250M	250 lbs	(1115)	22.24"	(565)	5.90"	(150)	.49"	(12.5)	Natural	25
111-25001	T250M0X2	T250M	250 lbs	(1115)	22.24"	(565)	5.90"	(150)	.49"	(12.5)	Black	25
T250I												
111-25219	T250I9X2	T250I	250 lbs	(1115)	28.54"	(725)	8.00"	(203)	.49"	(12.5)	Natural	25
111-00507	T250I0X2	T250I	250 lbs	(1115)	28.54"	(725)	8.00"	(203)	.49"	(12.5)	Black	25
T250L												
111-00436	T250L9X2	T250L	250 lbs	(1115)	34.65"	(880)	10.00"	(254)	.49"	(12.5)	Natural	25
111-24601	T250L0X2	T250L	250 lbs	(1115)	34.65"	(880)	10.00"	(254)	.49"	(12.5)	Black	25
T250XL												
111-00466	T250XL9X2	T250XL	250 lbs	(1115)	40.55"	(1030)	12.00"	(305)	.49"	(12.5)	Natural	25
111-25200	T250XL0X2	T250XL	250 lbs	(1115)	40.55"	(1030)	12.00"	(305)	.49"	(12.5)	Black	25

Installation tools - MK9, MK9HT, MK9P. Dimensions are approximate and subject to technical changes. Use **Part No.** for ordering and **Type** for specification purposes.

Heavy Duty Cable Ties

T255 Series

HellermannTyton's T255 series heavy duty cable ties are ideal for bundles requiring a strong cable tie that may also require a higher temperature rating than the T250 series. These ties have a tensile strength of 250 lbs.

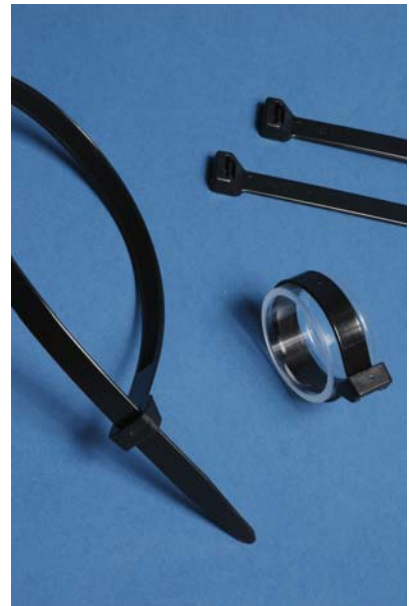

Material Data	
Material	Polyamide 6.6 high impact modified, heat stabilized (PA66HIRHS)
Operating Temperature	-40 °F to +230 °F (-40 °C to +110 °C) continuous
Flammability	UL94 HB

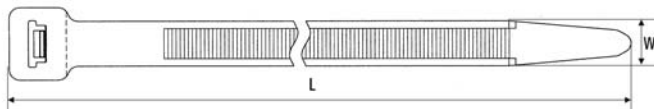

Product Selection			Min. Tensile Strength	Length (L)	Max. Ø Bundle	Width (W)	Color	Pkg. Qty.
Article No.	Part No.	Type						
111-25500	T255S0HIRX2	T255S	250 lbs (1115)	8.86" (225)	2.16" (55)	.49" (12.5)	Black	25
111-25400	T255R0HIRX2	T255R	250 lbs (1115)	20.28" (520)	5.71" (145)	.49" (12.5)	Black	25
111-25300	T255M0HIRX2	T255M	250 lbs (1115)	22.05" (565)	6.30" (160)	.49" (12.5)	Black	25

Installation tools - MK9, MK9HT, MK9P.

Dimensions are approximate and subject to technical changes. Use **Part No.** for ordering and **Type** for specification purposes.

Cable Ties

Standard Cable Ties T18R and T30R Series - Colors

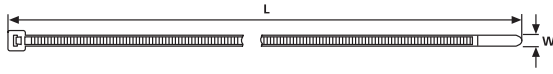

Material Data	
Material	Polyamide 6.6 (PA66)
Operating Temperature	-40 °F to +185 °F (-40 °C to +85 °C) continuous
Flammability	UL94 V2



File# E64139

File# E64139

Product Selection												
Article No.	Part No.	Type	Min. Tensile Strength		Length (L)		Max. Ø Bundle		Width (W)		Color	Pkg. Qty.
			lbs.	(N)	in.	(mm)	in.	(mm)	in.	(mm)		
T18R												
116-01811	T18R1C2	T18R	18 lbs	(80)	4"	(100)	.87"	(22)	.10"	(2.5)	Brown	100
111-01849	T18R1M4	T18R	18 lbs	(80)	4"	(100)	.87"	(22)	.10"	(2.5)		1000
111-01880	T18R2C2	T18R	18 lbs	(80)	4"	(100)	.87"	(22)	.10"	(2.5)	Red	100
111-01882	T18R2M4	T18R	18 lbs	(80)	4"	(100)	.87"	(22)	.10"	(2.5)		1000
116-01813	T18R3C2	T18R	18 lbs	(80)	4"	(100)	.87"	(22)	.10"	(2.5)	Orange	100
111-01877	T18R3M4	T18R	18 lbs	(80)	4"	(100)	.87"	(22)	.10"	(2.5)		1000
111-01896	T18R4C2	T18R	18 lbs	(80)	4"	(100)	.87"	(22)	.10"	(2.5)	Yellow	100
111-01898	T18R4M4	T18R	18 lbs	(80)	4"	(100)	.87"	(22)	.10"	(2.5)		1000
111-01853	T18R5C2	T18R	18 lbs	(80)	4"	(100)	.87"	(22)	.10"	(2.5)	Green	100
111-01855	T18R5M4	T18R	18 lbs	(80)	4"	(100)	.87"	(22)	.10"	(2.5)		1000
111-01842	T18R6C2	T18R	18 lbs	(80)	4"	(100)	.87"	(22)	.10"	(2.5)	Blue	100
111-01845	T18R6M4	T18R	18 lbs	(80)	4"	(100)	.87"	(22)	.10"	(2.5)		1000
116-01817	T18R7C2	T18R	18 lbs	(80)	4"	(100)	.87"	(22)	.10"	(2.5)	Purple	100
111-01888	T18R7M4	T18R	18 lbs	(80)	4"	(100)	.87"	(22)	.10"	(2.5)		1000
111-01857	T18R8C2	T18R	18 lbs	(80)	4"	(100)	.87"	(22)	.10"	(2.5)	Gray	100
111-01859	T18R8M4	T18R	18 lbs	(80)	4"	(100)	.87"	(22)	.10"	(2.5)		1000
116-01819	T18R10C2	T18R	18 lbs	(80)	4"	(100)	.87"	(22)	.10"	(2.5)	White	100
111-01892	T18R10M4	T18R	18 lbs	(80)	4"	(100)	.87"	(22)	.10"	(2.5)		1000
T30R												
116-03011	T30R1C2	T30R	30 lbs	(135)	5.9"	(150)	1.38"	(35)	.14"	(3.5)	Brown	100
111-03038	T30R1M4	T30R	30 lbs	(135)	5.9"	(150)	1.38"	(35)	.14"	(3.5)		1000
116-03012	T30R2C2	T30R	30 lbs	(135)	5.9"	(150)	1.38"	(35)	.14"	(3.5)	Red	100
111-03056	T30R2M4	T30R	30 lbs	(135)	5.9"	(150)	1.38"	(35)	.14"	(3.5)		1000
116-03013	T30R3C2	T30R	30 lbs	(135)	5.9"	(150)	1.38"	(35)	.14"	(3.5)	Orange	100
111-03052	T30R3M4	T30R	30 lbs	(135)	5.9"	(150)	1.38"	(35)	.14"	(3.5)		1000
116-03014	T30R4C2	T30R	30 lbs	(135)	5.9"	(150)	1.38"	(35)	.14"	(3.5)	Yellow	100
111-03065	T30R4M4	T30R	30 lbs	(135)	5.9"	(150)	1.38"	(35)	.14"	(3.5)		1000
116-03015	T30R5C2	T30R	30 lbs	(135)	5.9"	(150)	1.38"	(35)	.14"	(3.5)	Green	100
111-03041	T30R5M4	T30R	30 lbs	(135)	5.9"	(150)	1.38"	(35)	.14"	(3.5)		1000
116-03016	T30R6C2	T30R	30 lbs	(135)	5.9"	(150)	1.38"	(35)	.14"	(3.5)	Blue	100
111-03036	T30R6M4	T30R	30 lbs	(135)	5.9"	(150)	1.38"	(35)	.14"	(3.5)		1000
116-03017	T30R7C2	T30R	30 lbs	(135)	5.9"	(150)	1.38"	(35)	.14"	(3.5)	Purple	100
111-03062	T30R7M4	T30R	30 lbs	(135)	5.9"	(150)	1.38"	(35)	.14"	(3.5)		1000
116-03018	T30R8C2	T30R	30 lbs	(135)	5.9"	(150)	1.38"	(35)	.14"	(3.5)	Gray	100
111-03061	T30R8M4	T30R	30 lbs	(135)	5.9"	(150)	1.38"	(35)	.14"	(3.5)		1000
111-03019	T30R10C2	T30R	30 lbs	(135)	5.9"	(150)	1.38"	(35)	.14"	(3.5)	White	100
116-03064	T30R10M4	T30R	30 lbs	(135)	5.9"	(150)	1.38"	(35)	.14"	(3.5)		1000

Installation tools - MK7, MK7HT, MK7P, MK9, MK9HT, MK9P. MK9 and MK9P tools cannot be used to install T18S cable ties.

Dimensions are approximate and subject to technical changes. Use **Part No.** for ordering and **Type** for specification purposes.

Standard Cable Ties T50R and T50L Series - Colors

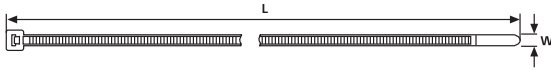

Material Data	
Material	Polyamide 6.6 (PA66)
Operating Temperature	-40 °F to +185 °F (-40 °C to +85 °C) continuous
Flammability	UL94 V2



File# E64139



File# E64139

Product Selection

Article No.	Part No.	Type	Min. Tensile Strength		Length (L)		Max. Ø Bundle		Width (W)		Color	Pkg. Qty.
			lbs.	(N)	in.	(mm)	in.	(mm)	in.	(mm)		
T50R												
116-05011	T50R1C2	T50R	50 lbs	(225)	7.9"	(200)	1.97"	(50)	.18"	(4.6)	Brown	100
111-04852	T50R1M4	T50R	50 lbs	(225)	7.9"	(200)	1.97"	(50)	.18"	(4.6)		1000
116-05012	T50R2C2	T50R	50 lbs	(225)	7.9"	(200)	1.97"	(50)	.18"	(4.6)	Red	100
111-04868	T50R2M4	T50R	50 lbs	(225)	7.9"	(200)	1.97"	(50)	.18"	(4.6)		1000
116-05013	T50R3C2	T50R	50 lbs	(225)	7.9"	(200)	1.97"	(50)	.18"	(4.6)	Orange	100
111-04865	T50R3M4	T50R	50 lbs	(225)	7.9"	(200)	1.97"	(50)	.18"	(4.6)		1000
116-05014	T50R4C2	T50R	50 lbs	(225)	7.9"	(200)	1.97"	(50)	.18"	(4.6)	Yellow	100
111-04892	T50R4M4	T50R	50 lbs	(225)	7.9"	(200)	1.97"	(50)	.18"	(4.6)		1000
116-05015	T50R5C2	T50R	50 lbs	(225)	7.9"	(200)	1.97"	(50)	.18"	(4.6)	Green	100
111-04854	T50R5M4	T50R	50 lbs	(225)	7.9"	(200)	1.97"	(50)	.18"	(4.6)		1000
116-05016	T50R6C2	T50R	50 lbs	(225)	7.9"	(200)	1.97"	(50)	.18"	(4.6)	Blue	100
111-04849	T50R6M4	T50R	50 lbs	(225)	7.9"	(200)	1.97"	(50)	.18"	(4.6)		1000
116-05017	T50R7C2	T50R	50 lbs	(225)	7.9"	(200)	1.97"	(50)	.18"	(4.6)	Purple	100
111-04877	T50R7M4	T50R	50 lbs	(225)	7.9"	(200)	1.97"	(50)	.18"	(4.6)		1000
111-04870	T50R8C2	T50R	50 lbs	(225)	7.9"	(202)	1.97"	(50)	.18"	(4.6)	Gray	100
111-04872	T50R8M4	T50R	50 lbs	(225)	7.9"	(200)	1.97"	(50)	.18"	(4.6)		1000
116-05019	T50R10C2	T50R	50 lbs	(225)	7.9"	(200)	1.97"	(50)	.18"	(4.6)	White	100
111-04879	T50R10M4	T50R	50 lbs	(225)	7.9"	(200)	1.97"	(50)	.18"	(4.6)		1000
T50L												
111-05443	T50L1C2	T50L	50 lbs	(225)	15.35"	(390)	4.33"	(110)	.18"	(4.6)	Brown	100
111-05444	T50L1M4	T50L	50 lbs	(225)	15.35"	(390)	4.33"	(110)	.18"	(4.6)		1000
111-05457	T50L2C2	T50L	50 lbs	(225)	15.35"	(390)	4.33"	(110)	.18"	(4.6)	Red	100
111-05458	T50L2M4	T50L	50 lbs	(225)	15.35"	(390)	4.33"	(110)	.18"	(4.6)		1000
111-05451	T50L3C2	T50L	50 lbs	(225)	15.35"	(390)	4.33"	(110)	.18"	(4.6)	Orange	100
111-05454	T50L3M4	T50L	50 lbs	(225)	15.35"	(390)	4.33"	(110)	.18"	(4.6)		1000
111-05467	T50L4C2	T50L	50 lbs	(225)	15.35"	(390)	4.33"	(110)	.18"	(4.6)	Yellow	100
111-05468	T50L4M4	T50L	50 lbs	(225)	15.35"	(390)	4.33"	(110)	.18"	(4.6)		1000
111-05445	T50L5C2	T50L	50 lbs	(225)	15.35"	(390)	4.33"	(110)	.18"	(4.6)	Green	100
111-00502	T50L5M4	T50L	50 lbs	(225)	15.35"	(390)	4.33"	(110)	.18"	(4.6)		1000
111-05431	T50L6C2	T50L	50 lbs	(225)	15.35"	(390)	4.33"	(110)	.18"	(4.6)	Blue	100
111-05434	T50L6M4	T50L	50 lbs	(225)	15.35"	(390)	4.33"	(110)	.18"	(4.6)		1000
111-05464	T50L7C2	T50L	50 lbs	(225)	15.35"	(390)	4.33"	(110)	.18"	(4.6)	Purple	100
111-00503	T50L7M4	T50L	50 lbs	(225)	15.35"	(390)	4.33"	(110)	.18"	(4.6)		1000
111-05461	T50L8C2	T50L	50 lbs	(225)	15.35"	(390)	4.33"	(110)	.18"	(4.6)	Gray	100
111-05462	T50L8M4	T50L	50 lbs	(225)	15.35"	(390)	4.33"	(110)	.18"	(4.6)		1000
111-05466	T50L10C2	T50L	50 lbs	(225)	15.35"	(390)	4.33"	(110)	.18"	(4.6)	White	100
111-05465	T50L10M4	T50L	50 lbs	(225)	15.35"	(390)	4.33"	(110)	.18"	(4.6)		1000

Installation tools - MK7, MK7HT, MK7P, MK9, MK9HT, MK9P.

Dimensions are approximate and subject to technical changes. Use **Part No.** for ordering and **Type** for specification purposes.

Cable Ties

Standard Cable Ties- Specialty Materials T18 -T120 Series - Heat Stabilized

HellermannTyton's heat stabilized cable ties provide excellent resistance when exposed to high heat applications.

Material Data	
Material	Polyamide 6.6 heat stabilized (PA66HS)
Operating Temperature	-40 °F to +221 °F (-40 °C to +105 °C) continuous
Flammability	UL94 V2

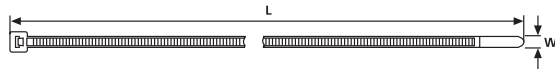

Product Selection		Type	Min. Tensile Strength		Length (L)		Max. Ø Bundle		Width (W)		Color	Pkg. Qty.
Article No.	Part No.		lbs. (N)	in. (mm)	in. (mm)	in. (mm)	in. (mm)	in. (mm)				
T18S												
111-02815	T18S0HSM4	T18S	18 lbs (80)	3.27" (83)	.63" (16)	.09" (2.3)			Black	1000		
T18R												
111-01905	T18R0HSC2	T18R	18 lbs (80)	4" (100)	.87" (22)	.10" (2.5)			Black	100		
111-00476	T18R0HSM4	T18R	18 lbs (80)	4" (100)	.87" (22)	.10" (2.5)			Black	1000		
T18I												
111-02305	T18I0HSM4	T18I	18 lbs (80)	5.5" (140)	1.38" (35)	.10" (2.5)			Black	1000		
T18L												
111-00403	T18L0HSC2	T18L	18 lbs (80)	8.0" (205)	2.17" (55)	.10" (2.5)			Black	100		
111-00404	T18L0HSM4	T18L	18 lbs (80)	8.0" (205)	2.17" (55)	.10" (2.5)			Black	1000		
T30R												
111-03067	T30R0HSC2	T30R	30 lbs (135)	5.9" (150)	1.38" (35)	.14" (3.5)			Black	100		
111-03068	T30R0HSM4	T30R	30 lbs (135)	5.9" (150)	1.38" (35)	.14" (3.5)			Black	1000		
T50R												
111-04900	T50R0HSC2	T50R	50 lbs (225)	7.9" (200)	1.97" (50)	.18" (4.6)			Black	100		
111-04901	T50R0HSM4	T50R	50 lbs (225)	7.9" (200)	1.97" (50)	.18" (4.6)			Black	1000		
T50I												
111-05248	T50I0HSC2	T50I	50 lbs (225)	11.8" (300)	3.35" (85)	.18" (4.6)			Black	100		
111-05251	T50I0HSM4	T50I	50 lbs (225)	11.8" (300)	3.35" (85)	.18" (4.6)			Black	1000		
T50L												
111-05470	T50L0HSC2	T50L	50 lbs (225)	15.35" (390)	4.33" (110)	.18" (4.6)			Black	100		
111-05471	T50L0HSM4	T50L	50 lbs (225)	15.35" (390)	4.33" (110)	.18" (4.6)			Black	1000		
T120R												
111-12061	T120R0HSK2	T120R	120 lbs (535)	15.24" (387)	4.13" (105)	.30" (7.6)			Black	50		
111-12058	T120R0HSH4	T120R	120 lbs (535)	15.24" (387)	4.13" (105)	.30" (7.6)			Black	500		

Installation tools - MK7, MK7HT, MK7P, MK9, MK9HT, MK9P. (MK9, MK9HT, and MK9P tools cannot be used with T18S cable tie)

Dimensions are approximate and subject to technical changes. Use **Part No.** for ordering and **Type** for specification purposes.

Standard Cable Ties- Specialty Materials T18 -T50 Series - Flame Retardant

HellermannTyton's flame retardant cable ties meet the UL 94V0 flammability requirements.

Material Data	
Material	Polyamide 6.6 V0 (PA66V0)
Operating Temperature	-40 °F to +185 °F (-40 °C to +85 °C) continuous
Flammability	UL94 V0

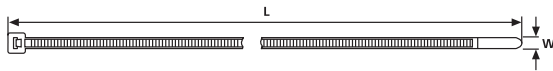

Product Selection		Type	Min. Tensile Strength		Length (L)		Max. Ø Bundle		Width (W)		Color	Pkg. Qty.
Article No.	Part No.		lbs.	(N)	in.	(mm)	in.	(mm)	in.	(mm)		
T18R												
111-01834	T18R9VOC2	T18R	18 lbs	(80)	4"	(100)	.87"	(22)	.10"	(2.5)	White	100
111-01835	T18R9VOM4	T18R	18 lbs	(80)	4"	(100)	.87"	(22)	.10"	(2.5)	White	1000
111-01833	T18R0VOC2	T18R	18 lbs	(80)	4"	(100)	.87"	(22)	.10"	(2.5)	Black	100
T18I												
111-02304	T18I9VOM4	T18I	18 lbs	(80)	5.5"	(144)	1.38"	(35)	.10"	(2.5)	White	1000
T18L												
111-02045	T18L9VOC2	T18L	18 lbs	(80)	7.95"	(202)	2.17"	(55)	.10"	(2.5)	White	100
111-02046	T18L9VOM4	T18L	18 lbs	(80)	7.95"	(202)	2.17"	(55)	.10"	(2.5)	White	1000
111-02044	T18L0VOC2	T18L	18 lbs	(80)	7.95"	(202)	2.17"	(55)	.10"	(2.5)	Black	100
T30R												
111-03073	T30R9VOC2	T30R	30 lbs	(135)	5.83"	(148)	1.38"	(35)	.14"	(3.6)	White	100
111-03074	T30R9VOM4	T30R	30 lbs	(135)	5.83"	(148)	1.38"	(35)	.14"	(3.6)	White	1000
111-03072	T30R0VOC2	T30R	30 lbs	(135)	5.83"	(148)	1.38"	(35)	.14"	(3.6)	Black	100
T50R												
111-04909	T50R9VOC2	T50R	50 lbs	(225)	7.95"	(202)	1.97"	(50)	.18"	(4.6)	White	100
111-04911	T50R9VOM4	T50R	50 lbs	(225)	7.95"	(202)	1.97"	(50)	.18"	(4.6)	White	1000
111-04887	T50R0VOC2	T50R	50 lbs	(225)	7.95"	(202)	1.97"	(50)	.18"	(4.6)	Black	100
111-04908	T50R0VOM4	T50R	50 lbs	(225)	7.95"	(202)	1.97"	(50)	.18"	(4.6)	Black	1000
T50I												
111-05254	T50I9VOC2	T50I	50 lbs	(225)	11.82"	(300)	3.35"	(85)	.18"	(4.6)	White	100
111-05255	T50I9VOM4	T50I	50 lbs	(225)	11.82"	(300)	3.35"	(85)	.18"	(4.6)	White	1000
111-05258	T50I0VOC2	T50I	50 lbs	(225)	11.82"	(300)	3.35"	(85)	.18"	(4.6)	Black	100
T50L												
111-05438	T50L9VOC2	T50L	50 lbs	(225)	15.35"	(390)	4.33"	(110)	.19"	(4.7)	White	100
111-05476	T50L9VOM4	T50L	50 lbs	(225)	15.35"	(390)	4.33"	(110)	.19"	(4.7)	White	1000
111-05475	T50L0VOC2	T50L	50 lbs	(225)	15.35"	(390)	4.33"	(110)	.19"	(4.7)	Black	100

Installation tools - MK7, MK7HT, MK7P, MK9, MK9HT, MK9P.

Dimensions are approximate and subject to technical changes. Use **Part No.** for ordering and **Type** for specification purposes.

Cable Ties

Standard Cable Ties- Specialty Materials T18 -T120 Series - Polypropylene

HellermannTyton's polypropylene cable ties offer added resistance to most chemicals.

Material Data	
Material	Polypropylene (PP)
Operating Temperature	-40 °F to +239 °F (-40 °C to +115 °C) continuous
Flammability	UL94 HB

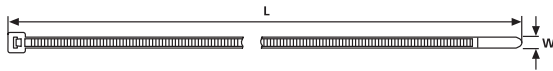

Product Selection			Min. Tensile Strength	Length (L)	Max. Ø Bundle	Width (W)	Color	Pkg. Qty.
Article No.	Part No.	Type						
T18R								
111-01921	T18R9PPC2	T18R	11 lbs (49)	4" (100)	.75" (19)	.10" (2.5)	Natural	100
111-01922	T18R9PPM4	T18R	11 lbs (49)	4" (100)	.75" (19)	.10" (2.5)	Natural	1000
111-01917	T18R0PPC2	T18R	11 lbs (49)	4" (100)	.75" (19)	.10" (2.5)	Black	100
111-01918	T18R0PPM4	T18R	11 lbs (49)	4" (100)	.75" (19)	.10" (2.5)	Black	1000
T30R								
111-03017	T30R9PPC2	T30R	20 lbs (89)	5.83" (148)	1.26" (32)	.14" (3.6)	Natural	100
T50R								
111-04931	T50R9PPC2	T50R	30 lbs (133)	8.0" (203.8)	1.75" (44.5)	.19" (4.7)	Natural	100
111-04928	T50R0PPC2	T50R	30 lbs (133)	8.0" (203.8)	1.75" (44.5)	.19" (4.7)	Black	100
111-04929	T50R0PPM4	T50R	30 lbs (133)	8.0" (203.8)	1.75" (44.5)	.19" (4.7)	Black	1000
T50I								
111-05262	T50I9PPM4	T50I	30 lbs (133)	11.8" (300)	3.35" (85)	.18" (4.6)	Natural	1000
T50L								
111-05483	T50L9PPM4	T50L	30 lbs (133)	15.35" (390)	4.33" (110)	.18" (4.7)	Natural	1000
111-05482	T50L0PPC2	T50L	30 lbs (133)	15.35" (390)	4.33" (110)	.18" (4.7)	Black	100
T120R								
111-12067	T120R0PPK2	T120R	60 lbs (267)	15.35" (390)	4.13" (105)	.30" (7.6)	Black	50
111-12066	T120R0PPH4	T120R	60 lbs (267)	15.35" (390)	4.13" (105)	.30" (7.6)	Black	500

Installation tools - MK7, MK7HT, MK7P, MK9, MK9HT, MK9P.

Dimensions are approximate and subject to technical changes. Use **Part No.** for ordering and **Type** for specification purposes.

Cable Ties for Plenum Applications

HellermannTyton halar and U.L. Listed cable ties meet NEC regulations and can be used in applications where low smoke and low flame are a concern in air handling spaces.



Halar Cable Ties

The raw material used to manufacture HellermannTyton halar cable ties is UL 94V0 rated. The halar ties come in a distinct color of red for easy identification.

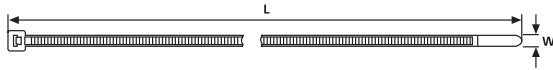

Material Data	
Material	PA66HL
Operating Temperature	-104 °F to +300 °F (-76 °C to +150 °C) continuous
Flammability	UL94 V0



Product Selection

Article No.	Part No.	Type	Min. Tensile Strength		Length (L)		Max. Ø Bundle		Width (W)		Color	Pkg. Qty.
			lbs.	(N)	in.	(mm)	in.	(mm)	in.	(mm)		
111-01900	T18R2HALC2	T18R	14 lbs	(80)	4"	(100)	.87"	(22)	.10"	(2.45)	Red	100
111-01902	T18R2HALM4	T18R	14 lbs	(80)	4"	(100)	.87"	(22)	.10"	(2.45)	Red	1000
111-04895	T50R2HALC2	T50R	40 lbs	(177.9)	8.0"	(203.2)	1.75"	(44.45)	.176"	(4.5)	Red	100
111-04897	T50R2HALM4	T50R	40 lbs	(177.9)	8.0"	(203.2)	1.75"	(44.45)	.176"	(4.5)	Red	1000
111-12056	T120R2HALK2	T120R	80 lbs	(355.9)	15.5"	(394.4)	4.0"	(101.6)	.31"	(7.8)	Red	50
111-12055	T120R2HALH4	T120R	80 lbs	(355.9)	15.5"	(394.4)	4.0"	(101.6)	.31"	(7.8)	Red	500

Note: Halar ties are also available in natural color. Contact HellermannTyton for availability. Halar is a registered trademark of Solvay S.A.

Installation tools - MK7, MK7HT, MK7P, MK9, MK9HT, MK9P. Dimensions are approximate and subject to technical changes. Use **Part No.** for ordering and **Type** for specification purposes.

UL Rated Cable Ties

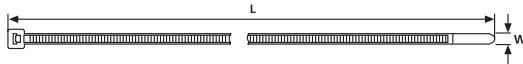

Material Data	
Material	Polyamide 6.6 (PA66)
Operating Temperature	-40 °F to +185 °F (-40 °C to +85 °C) continuous
Flammability	UL94 V2



File# E64139

File# E64139

Product Selection

Article No.	Part No.	Type	Min. Tensile Strength		Length (L)		Max. Ø Bundle		Width (W)		Color	Pkg. Qty.
			lbs.	(N)	in.	(mm)	in.	(mm)	in.	(mm)		
111-00508	T18R9C2UL	T18R	18 lbs	(80)	4"	(100)	.86"	(22)	.10"	(2.5)	Natural	100
111-00509	T18R9M4UL	T18R	18 lbs	(80)	4"	(100)	.86"	(22)	.10"	(2.5)	Natural	1000
111-00510	T18R2C2UL	T18R	18 lbs	(80)	4"	(100)	.86"	(22)	.10"	(2.5)	Red	100
111-00511	T18R2M4UL	T18R	18 lbs	(80)	4"	(100)	.86"	(22)	.10"	(2.5)	Red	1000
111-00512	T50R9C2UL	T50R	50 lbs	(225)	7.9"	(200)	1.97"	(50)	.18"	(4.6)	Natural	100
111-00513	T50R9M4UL	T50R	50 lbs	(225)	7.9"	(200)	1.97"	(50)	.18"	(4.6)	Natural	1000
111-00514	T50R2C2UL	T50R	50 lbs	(225)	7.9"	(200)	1.97"	(50)	.18"	(4.6)	Red	100
111-00515	T50R2M4UL	T50R	50 lbs	(225)	7.9"	(200)	1.97"	(50)	.18"	(4.6)	Red	1000
111-00516	T50I9C2UL	T50I	50 lbs	(225)	11.8"	(300)	3.35"	(85)	.18"	(4.6)	Natural	100
111-00517	T50I9M4UL	T50I	50 lbs	(225)	11.8"	(300)	3.35"	(85)	.18"	(4.6)	Natural	1000
111-00518	T50I2C2UL	T50I	50 lbs	(225)	11.8"	(300)	3.35"	(85)	.18"	(4.6)	Red	100
111-00519	T50I2M4UL	T50I	50 lbs	(225)	11.8"	(300)	3.35"	(85)	.18"	(4.6)	Red	1000
111-00520	T50L9C2UL	T50L	50 lbs	(225)	15.35"	(390)	4.33"	(110)	.18"	(4.6)	Natural	100
111-00521	T50L9M4UL	T50L	50 lbs	(225)	15.35"	(390)	4.33"	(110)	.18"	(4.6)	Natural	1000
111-00522	T50L2C2UL	T50L	50 lbs	(225)	15.35"	(390)	4.33"	(110)	.18"	(4.6)	Red	100
111-00523	T50L2M4UL	T50L	50 lbs	(225)	15.35"	(390)	4.33"	(110)	.18"	(4.6)	Red	1000

Installation tools - MK7, MK7HT, MK7P, MK9, MK9HT, MK9P. Dimensions are approximate and subject to technical changes. Use **Part No.** for ordering and **Type** for specification purposes.

Cable Ties

Tefzel® Cable Ties

Tefzel ties provide excellent protection against radiation, ultraviolet light, and a wide range of chemicals. They are also rated for low outgassing applications. HellermannTyton's Tefzel ties come in a standard color of blue for easy identification.

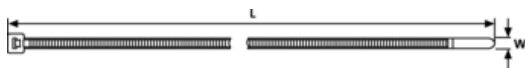

Material Data	
Material	Ethylentetrafluoroethylene - Tefzel (E/TFE)
Operating Temperature	-112 °F to +302 °F (-80 °C to +150 °C) continuous
Flammability	UL94 V0



Product Selection			Min. Tensile Strength	Length (L)	Max. Ø Bundle	Width (W)	Color	Pkg. Qty.
Article No.	Part No.	Type						
111-01923	T18R6TZC2	T18R(U)	9.0 lbs (40)	4" (100)	.87" (22)	.10" (2.5)	Blue	100
111-01924	T18R6TZM4	T18R(U)	9.0 lbs (40)	4" (100)	.87" (22)	.10" (2.5)	Blue	1000
111-05026	T50R6TZC2	T50R(U)	35.5 lbs (158)	8" (200)	1.75" (50)	.18" (4.6)	Blue	100
111-04933	T50R6TZM4	T50R(U)	35.5 lbs (158)	8" (200)	1.75" (50)	.18" (4.6)	Blue	1000
111-12026	T120R6TZK2	T120R	70 lbs (311)	15" (380)	4.0" (100)	.30" (7.6)	Blue	50

Tefzel is a registered trademark of E.I. DuPont Corporation. Installation tools - MK7, MK7HT, MK7P, MK9, MK9HT, MK9P.

Dimensions are approximate and subject to technical changes. Use **Part No.** for ordering and **Type** for specification purposes.

Outside Serrated Cable Ties

The outside serrated cable ties are for specific applications where thin walled or soft insulation is used (such as in aircraft, trains, etc.) and for applications that are very sensitive to the amount of force applied to the cable.



Material Data	
Material	Polyamide 6.6 heat stabilized (PA66HS)
Operating Temperature	-40 °F to +221 °F (-40 °C to +105 °C) continuous
Flammability	UL94 V2



Outside serrated cable ties are also available in natural.

Contact HellermannTyton for more information.

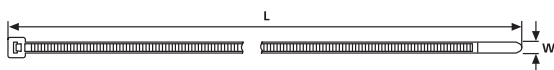

Product Selection			Min. Tensile Strength	Length (L)	Max. Ø Bundle	Width (W)	Color	Pkg. Qty.
Article No.	Part No.	Type						
118-04700	118-04700	T18ROS	18 lbs (80)	3.94" (100)	.79" (20)	.10" (2.5)	Black	100
118-04800	118-04800	T30ROS	30 lbs (135)	5.71" (145)	1.34" (35)	.13" (3.4)	Black	100
118-04900	118-04900	T30LOS	30 lbs (135)	7.87" (200)	2.0" (50)	.13" (3.4)	Black	100
118-05850	118-05850	T50SOS	50 lbs (225)	5.9" (150)	1.38" (35)	.18" (4.6)	Black	100
118-05050	118-05050	T50ROS	50 lbs (225)	8" (200)	1.95" (50)	.18" (4.6)	Black	100
118-05900	118-05900	T50LOS	50 lbs (225)	15" (384)	4.29" (110)	.18" (4.6)	Black	100

Installation tools - MK7, MK7HT, MK7P, MK9, MK9HT, MK9P. Dimensions are approximate and subject to technical changes. Use **Part No.** for ordering and **Type** for specification purposes.

Releasable Ties

The extended pawl allows for simple and quick release of the ties. Perfect for prototype construction and service requiring the addition of wires on existing harnesses.

Material Data	
Material	Polyamide 6.6 (PA66)
Operating Temperature	-40 °F to +185 °F (-40 °C to +85 °C) continuous
Flammability	UL94 V2

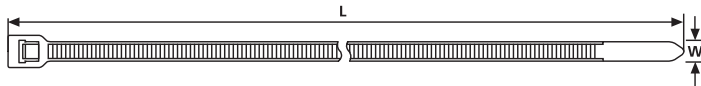

RT40R



RT50S and RT50LL

US
File# E64139

Product Selection			Min. Tensile Strength	Length (L)	Max. Ø Bundle	Width (W)	Color	Pkg. Qty.
Article No.	Part No.	Type						
RT40R								
115-06219	RT40R9C2	RT40R	34 lbs (150)	8.46" (215)	2.0" (51)	.16" (4.0)	Natural	100
115-06204	RT40R9M4	RT40R	34 lbs (150)	8.46" (215)	2.0" (51)	.16" (4.0)		1000
115-06200	RT40R0C2	RT40R	34 lbs (150)	8.46" (215)	2.0" (51)	.16" (4.0)	Black	100
115-06202	RT40R0M4	RT40R	34 lbs (150)	8.46" (215)	2.0" (51)	.16" (4.0)		1000
RT50S								
115-06319	RT50S9C2	RT50S	50 lbs (225)	6.5" (165)	1.38" (35)	.18" (4.6)	Natural	100
115-06304	RT50S9M4	RT50S	50 lbs (225)	6.5" (165)	1.38" (35)	.18" (4.6)		1000
115-06300	RT50S0C2	RT50S	50 lbs (225)	6.5" (165)	1.38" (35)	.18" (4.6)	Black	100
115-00035	RT50S0M4	RT50S	50 lbs (225)	6.5" (165)	1.38" (35)	.18" (4.6)		1000
RT50LL								
115-06102	RT50LL9C2	RT50LL	50 lbs (225)	15" (380)	3.98" (101)	.18" (4.6)	Natural	100
115-06104	RT50LL9M4	RT50LL	50 lbs (225)	15" (380)	3.98" (101)	.18" (4.6)		1000
115-00039	RT50LL0C2	RT50LL	50 lbs (225)	15" (380)	3.98" (101)	.18" (4.6)	Black	100
115-06101	RT50LL0M4	RT50LL	50 lbs (225)	15" (380)	3.98" (101)	.18" (4.6)		1000

Dimensions are approximate and subject to technical changes. Use **Part No.** for ordering and **Type** for specification purposes.

Cable Ties

REL Releasable Ties

Ideal for use in applications where there is the need to repeatedly open and close the tie.



Material Data		RoHS
Material	Polyamide 6.6 (PA66)	
Operating Temperature	-40 °F to +185 °F (-40 °C to +85 °C) continuous	
Flammability	UL94 V2	

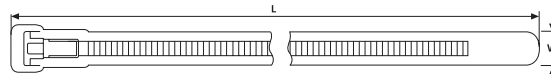

Product Selection												
Article No.	Part No.	Type	Min. Tensile Strength		Length (L)		Max. Ø Bundle		Width (W)		Color	Pkg. Qty.
			lbs.	(N)	in.	(mm)	in.	(mm)	in.	(mm)		
REL50R												
115-00503	REL50R9C2	REL50R	50 lbs	(225)	5.5"	(140)	1.38"	(35)	.29" (7.4)		Natural	100
115-00505	REL50R9L4	REL50R	50 lbs	(225)	5.5"	(140)	1.38"	(35)	.29" (7.4)			200
115-00500	REL50R0C2	REL50R	50 lbs	(225)	5.5"	(140)	1.38"	(35)	.29" (7.4)			Black
115-00502	REL50R0L4	REL50R	50 lbs	(225)	5.5"	(140)	1.38"	(35)	.29" (7.4)		200	
REL50L												
115-00605	REL50L9C2	REL50L	50 lbs	(225)	9.84"	(250)	2.76"	(70)	.29" (7.4)		Natural	100
115-00607	REL50L9L4	REL50L	50 lbs	(225)	9.84"	(250)	2.76"	(70)	.29" (7.4)			200
115-00600	REL50L0C2	REL50L	50 lbs	(225)	9.84"	(250)	2.76"	(70)	.29" (7.4)			Black
115-00602	REL50L0L4	REL50L	50 lbs	(225)	9.84"	(250)	2.76"	(70)	.29" (7.4)		200	

Dimensions are approximate and subject to technical changes. Use **Part No.** for ordering and **Type** for specification purposes.

Pinch Releasable Ties

Patented pinch release mechanism for easy handling allows tie to be released using one hand.

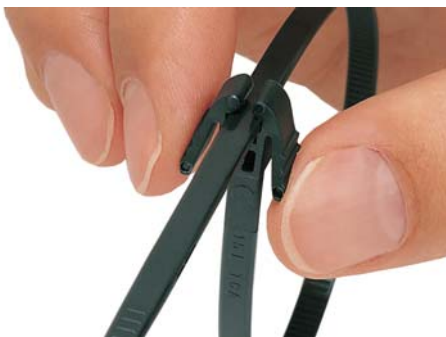

Material Data		RoHS
Material	Polyamide 6.6 (PA66)	
Operating Temperature	-40 °F to +185 °F (-40 °C to +85 °C) continuous	
Flammability	UL94 V2	

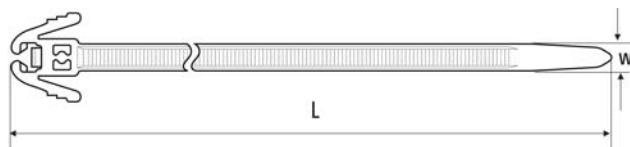

Product Selection												
Article No.	Part No.	Type	Min. Tensile Strength		Length (L)		Max. Ø Bundle		Width (W)		Color	Pkg. Qty.
			lbs.	(N)	in.	(mm)	in.	(mm)	in.	(mm)		
115-40200	REZ200.NB3P	REZ200	30 lbs	(135)	7.88"	(200)	1.97"	(50)	.19" (4.7)		Black	100
115-40300	REZ300.NB3P	REZ300	30 lbs	(135)	12.00"	(305)	3.15"	(80)	.19" (4.7)		Black	100

Dimensions are approximate and subject to technical changes. Use **Part No.** for ordering and **Type** for specification purposes.

Heavy Duty Releasable Cable Ties

The RT150 and RT250 heavy duty releasable cable ties feature an extended pawl which allows for simple and quick release of the ties.

RT150 Heavy Duty Releasable Cable Ties

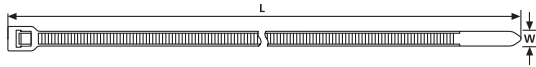

Material Data	
Material	Polyamide 6.6 (PA66)
Operating Temperature	-40 °F to +185 °F (-40 °C to +85 °C) continuous
Flammability	UL94 V2



Product Selection			Min. Tensile Strength	Length (L)	Max. Ø Bundle	Width (W)	Color	Pkg. Qty.
Article No.	Part No.	Type						
115-00036	RT150REP0X2	RT150REP	175 lbs (780)	15.35" (390)	4" (105)	.346" (8.8)	Black	25
115-00037	RT150MEP0X2	RT150MEP	175 lbs (780)	21.06" (535)	5.90" (150)	.346" (8.8)	Black	25
115-00038	RT150LEP0X2	RT150LEP	175 lbs (780)	32.28" (820)	9.65" (245)	.346" (8.8)	Black	25

Dimensions are approximate and subject to technical changes. Use **Part No.** for ordering and **Type** for specification purposes.

RT250 Heavy Duty Releasable Cable Ties

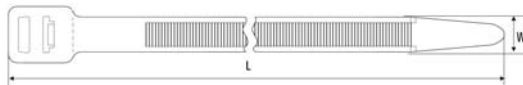

Material Data	
Material	Polyamide 6.6 (PA66)
Operating Temperature	-40 °F to +185 °F (-40 °C to +85 °C) continuous
Flammability	UL94 V2



UL
US
File# E64139

Product Selection			Min. Tensile Strength	Length (L)	Max. Ø Bundle	Width (W)	Color	Pkg. Qty.
Article No.	Part No.	Type						
RT250S								
131-75819	RT250S9X2	RT250S	250 lbs (1115)	9.05" (230)	2.17" (55)	.49" (12.5)	Natural	25
115-41800	RT250S0X2	RT250S	250 lbs (1115)	9.05" (230)	2.17" (55)	.49" (12.5)	Black	25
RT250R								
131-75019	RT250R9X2	RT250R	250 lbs (1115)	20.47" (520)	5.71" (145)	.49" (12.5)	Natural	25
115-41300	RT250R0X2	RT250R	250 lbs (1115)	20.47" (520)	5.71" (145)	.49" (12.5)	Black	25
RT250M								
131-75619	RT250M9X2	RT250M	250 lbs (1115)	22.24" (565)	5.90" (150)	.49" (12.5)	Natural	25
131-75610	RT250M0X2	RT250M	250 lbs (1115)	22.24" (565)	5.90" (150)	.49" (12.5)	Black	25
RT250I								
131-75219	RT250I9X2	RT250I	250 lbs (1115)	28.54" (725)	8.00" (203)	.49" (12.5)	Natural	25
115-41401	RT250I0X2	RT250I	250 lbs (1115)	28.54" (725)	8.00" (203)	.49" (12.5)	Black	25
RT250L								
131-75419	RT250L9X2	RT250L	250 lbs (1115)	34.65" (880)	10.00" (254)	.49" (12.5)	Natural	25
115-41500	RT250L0X2	RT250L	250 lbs (1115)	34.65" (880)	10.00" (254)	.49" (12.5)	Black	25
RT250XL								
131-75519	RT250XL9X2	RT250XL	250 lbs (1115)	40" (1016.0)	12" (304.8)	.49" (12.5)	Natural	25
131-75510	RT250XL0X2	RT250XL	250 lbs (1115)	40" (1016.0)	12" (304.8)	.49" (12.5)	Black	25

Dimensions are approximate and subject to technical changes. Use **Part No.** for ordering and **Type** for specification purposes.

Cable Ties

Heavy Duty Releasable Cable Ties RT255 Heavy Duty Releasable Ties

Material Data	
Material	Polyamide 6.6 high impact modified, heat stabilized (PA66HIRHS)
Operating Temperature	-40 °F to +230 °F (-40 °C to +110 °C) continuous
Flammability	UL94 HB

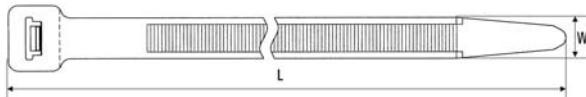

Product Selection			Min. Tensile Strength	Length (L)	Max. Ø Bundle	Width (W)	Color	Pkg. Qty.
Article No.	Part No.	Type						
115-01200	RT255S0HIRX2	RT255S	250 lbs (1112)	8.86" (225)	2.16" (55)	.49" (12.5)	Black	25
115-01300	RT255R0HIRX2	RT255R	250 lbs (1112)	20.28" (515)	5.71" (145)	.49" (12.5)	Black	25
115-01400	RT255M0HIRX2	RT255M	250 lbs (1112)	22.05" (560)	6.30" (160)	.49" (12.5)	Black	25

Dimensions are approximate and subject to technical changes. Use **Part No.** for ordering and **Type** for specification purposes.

SR255 Heavy Duty Sub-Releasable Ties

The SR255 series releasable heavy duty cable tie offers a release that is lower than the head of the cable tie, facilitating easy installation with the use of a HellermannTyton cable tie tool.

Material Data	
Material	Polyamide 6.6 high impact modified, heat stabilized (PA66HIRHS)
Operating Temperature	-40 °F to +230 °F (-40 °C to +110 °C) continuous
Flammability	UL94 HB

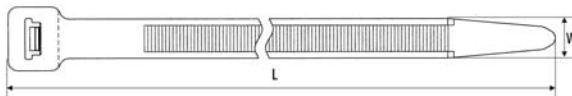

Product Selection			Min. Tensile Strength	Length (L)	Max. Ø Bundle	Width (W)	Color	Pkg. Qty.
Article No.	Part No.	Type						
115-42002	SR255S0HIHSUVX2	SR255S	250 lbs (1112)	8.86" (225)	2.16" (50)	.49" (12.5)	Black	25
115-42101	SR255X0HIHSUVX2	SR255X	250 lbs (1112)	14" (372)	3.94" (100)	.49" (12.5)	Black	25

Installation tools - MK9, MK9HT, MK9P. Dimensions are approximate and subject to technical changes. Use **Part No.** for ordering and **Type** for specification purposes.

Speedy Tie

An entirely new design in cable management, the SpeedyTie is a fully re-usable, easily releasable lashing tie. The SpeedyTie's unique design allows it to be released with one hand.

- Just one click to tie and untie
- Fully re-usable
- Once applied, the tail can be neatly tucked away for added safety
- Highly visible yellow color — also available in black, high impact modified material
- Versatile design allows use for multiple applications

The SpeedyTie is a versatile tool for countless applications:

- Electrical Contractors
- Heating & Ventilation Contractors
- Residential Construction
- General and Heavy Industry
- Packaging
- Tubing and Pipe Bundling
- An "Extra Hand" for Overhead Installations
- In Plant Transfer of Products

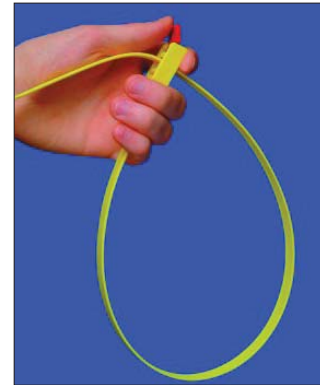

SpeedyTie - Quick and easy.



Speedy Tie is particularly suited for temporary but safe bundling or fixing.

Packaging Configurations

Distributor Packs

- Printed bag with a hang hole
- Display box
- 60 SpeedyTies - 12 bags of 5

OEM Packs

- Plain bag (no hang hole)
- Standard box
- 300 SpeedyTies - 12 bags of 25



Distributor Pack - point of purchase display for the SpeedyTie.

Material Data	
Material	Polyamide 6.6 (PA66)
Color	Yellow , Red
Operating Temperature	-40 °F to +185 °F (-40 °C to +85 °C) continuous
Flammability	UL94 V2

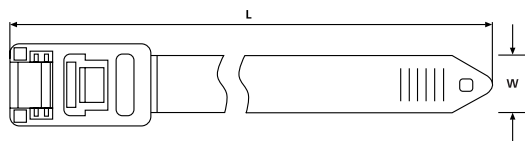

Product Selection		Type	Description	Min. Tensile Strength	Length (L)	Max. Ø Bundle	Width (W)	Pkg. Qty.	Carton Qty.
Article No.	Part No.			lbs. (N)	in. (mm)	in. (mm)	in. (mm)		
115-00001	RTT750HR.NX900	RTT750HR	Distributor Pack - order in carton qty. only	200 lbs (888)	29.52" (750)	8.27" (210)	.51" (13)	5	60
115-00000	RTT750HR.NX1P	RTT750HR	OEM Pack - order in carton qty. only	200 lbs (888)	29.52" (750)	8.27" (210)	.51" (13)	25	300

Dimensions are approximate and subject to technical changes. Use **Part No.** for ordering and **Type** for specification purposes.

Cable Ties

Clamp Ties

The clamp tie has triangular shaped tabs extending beneath the head, allowing for optimal surface contact and complete circumferential compression to 360 degrees. The clamps are recommended for soft rubber hose applications including fuel, water, and air vacuum lines.



Material Data		RoHS
Color	Natural	
Material	Polyamide 6.6 (PA66)	
Operating Temperature	-40 °F to +185 °F (-40 °C to +85 °C) continuous	
Flammability	UL94 V2	

Material Data		RoHS
Color	Black	
Material	Polyamide 6.6 heat stabilized (PA66HS)	
Operating Temperature	-40 °F to +221 °F (-40 °C to +105 °C) continuous	
Flammability	UL94 V2	

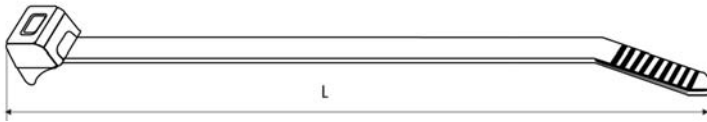

US
File# E64139

Product Selection			Min. Tensile Strength	Length (L)	Max. Ø Bundle	Width (W)	Color	Pkg. Qty.
Article No.	Part No.	Type						
CTT20R								
112-51919	CTT20R9C2	CTT20R	20 lbs (90)	4" (100)	.50" (13)	.10" (2.5)	Natural	100
112-51904	CTT20R9M4	CTT20R	20 lbs (90)	4" (100)	.50" (13)	.10" (2.5)		1000
112-51905	CTT20R0HSC2	CTT20R	20 lbs (90)	4" (100)	.50" (13)	.10" (2.5)	Black	100
112-51960	CTT20R0HSM4	CTT20R	20 lbs (90)	4" (100)	.50" (13)	.10" (2.5)		1000
CTT60R								
112-52104	CTT60R9C2	CTT60R	60 lbs (265)	8" (205)	1.77" (45)	.19" (4.7)	Natural	100
112-52106	CTT60R9M4	CTT60R	60 lbs (265)	8" (205)	1.77" (45)	.19" (4.7)		1000
112-52112	CTT60R0HSC2	CTT60R	60 lbs (265)	8" (205)	1.77" (45)	.19" (4.7)	Black	100
112-52114	CTT60R0HSM4	CTT60R	60 lbs (265)	8" (205)	1.77" (45)	.19" (4.7)		1000

Installation tools - MK7, MK7HT, MK7P, MK9, MK9HT, MK9P. Dimensions are approximate and subject to technical changes. Use **Part No.** for ordering and **Type** for specification purposes.

Double Head Ties

Designed to harness two bundles simultaneously. The second loop may also serve as a positioning device for a single bundle.

Material Data	
Material	Polyamide 6.6 (PA66)
Operating Temperature	-40 °F to +185 °F (-40 °C to +85 °C) continuous
Flammability	UL94 V2

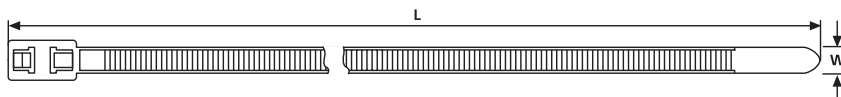

US
File# E64139

Product Selection		Type	Min. Tensile Strength		Length (L)		Width (W)		Color	Pkg. Qty.
Article No.	Part No.		lbs.	(N)	in.	(mm)	in.	(mm)		
T50SDH										
117-00016	117-00016	T50SDH	50 lbs	(225)	6.26"	(159)	.19"	(4.7)	Natural	100
117-00017	117-00017	T50SDH	50 lbs	(225)	6.26"	(159)	.19"	(4.7)		1000
117-00018	117-00018	T50SDH	50 lbs	(225)	6.26"	(159)	.19"	(4.7)	Black	100
117-00019	117-00019	T50SDH	50 lbs	(225)	6.26"	(159)	.19"	(4.7)		1000
T50RDH										
117-05006	T50RDH9C2	T50RDH	50 lbs	(225)	8.25"	(210)	.19"	(4.7)	Natural	100
117-05008	T50RDH9M4	T50RDH	50 lbs	(225)	8.25"	(210)	.19"	(4.7)		1000
117-05004	T50RDH0C2	T50RDH	50 lbs	(225)	8.25"	(210)	.19"	(4.7)	Black	100
117-05005	T50RDH0M4	T50RDH	50 lbs	(225)	8.25"	(210)	.19"	(4.7)		1000
T50IDH										
117-05302	T50IDH9C2	T50IDH	50 lbs	(225)	12"	(305)	.19"	(4.7)	Natural	100
117-05303	T50IDH9M4	T50IDH	50 lbs	(225)	12"	(305)	.19"	(4.7)		1000
117-05362	T50IDH0C2	T50IDH	50 lbs	(225)	12"	(305)	.19"	(4.7)	Black	100
117-05300	T50IDH0M4	T50IDH	50 lbs	(225)	12"	(305)	.19"	(4.7)		1000
T50LDH										
117-05402	T50LDH9C2	T50LDH	50 lbs	(225)	15.5"	(395)	.19"	(4.7)	Natural	100
117-05461	T50LDH9M4	T50LDH	50 lbs	(225)	15.5"	(395)	.19"	(4.7)		1000
117-05400	T50LDH0C2	T50LDH	50 lbs	(225)	15.5"	(395)	.19"	(4.7)	Black	100
117-05401	T50LDH0M4	T50LDH	50 lbs	(225)	15.5"	(395)	.19"	(4.7)		1000

Maximum bundle diameter is variable due to double loops. Installation tools - MK7, MK7HT, MK7P, MK9, MK9HT, MK9P.

Dimensions are approximate and subject to technical changes. Use **Part No.** for ordering and **Type** for specification purposes.

Cable Ties

Identification Ties

Tie and identify bundles of cable in one operation. Large flat area for imprinting or writing the required information. Hot stamping available, which is subject to minimums and lead times.

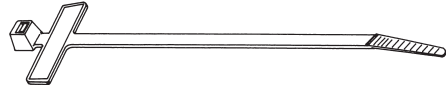

IT18R

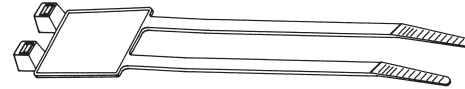

IT50RD



IT18FL

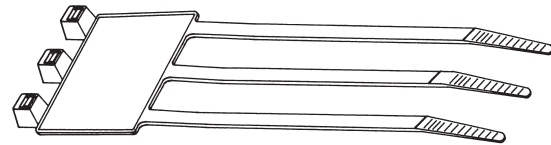

IT50RT

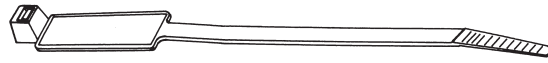

IT50R



IT50L

Material Data	
Material	Polyamide 6.6 (PA66)
Operating Temperature	-40 °F to +185 °F (-40 °C to +85 °C) continuous
Flammability	UL94 V2



HellermannTyton offers marking pens for use with the identification ties, see page 179.



Product Selection

Article No.	Part No.	Type	US Gov. Designation	Min. Tensile Strength	Length (L)	Max. Ø Bundle	Width (W)	Color	Pkg. Qty.	
				lbs. (N)	in. (mm)	in. (mm)	in. (mm)			
IT18R Marking Pad Size: .98" x .32" (25 x 8)										
111-81819	IT18R9C2	IT18R	MS3368-5-9E	18 lbs (80)	3.94" (100)	.75" (22.0)	.09" (2.3)	Natural	100	
111-81808	IT18R9L4	IT18R	MS3368-5-9E	18 lbs (80)	3.94" (100)	.75" (22.0)	.09" (2.3)	Natural	200	
111-81801	IT18R0C2	IT18R	*	18 lbs (80)	3.94" (100)	.75" (22.0)	.09" (2.3)	Black	100	
111-81803	IT18R0L4	IT18R	*	18 lbs (80)	3.94" (100)	.75" (22.0)	.09" (2.3)	Black	200	
IT18FL Marking Pad Size: .81" x .35" (20.5 x 9)										
111-81919	IT18FL9C2	IT18FL	-	18 lbs (80)	4.33" (110)	.75" (19.0)	.10" (2.5)	Natural	100	
111-81907	IT18FL9L4	IT18FL	-	18 lbs (80)	4.33" (110)	.75" (19.0)	.10" (2.5)	Natural	200	
111-81910	IT18FL0C2	IT18FL	-	18 lbs (80)	4.33" (110)	.75" (19.0)	.10" (2.5)	Black	100	
111-81903	IT18FL0L4	IT18FL	-	18 lbs (80)	4.33" (110)	.75" (19.0)	.10" (2.5)	Black	200	
IT50R Marking Pad Size: 1.10" x .51" (28 x 12.9)										
111-85019	IT50R9C2	IT50R	MS3368-1-9A	50 lbs (225)	7.99" (203)	1.75" (44.5)	.18" (4.6)	Natural	100	
111-85020	IT50R9M4	IT50R	MS3368-1-9A	50 lbs (225)	7.99" (203)	1.75" (44.5)	.18" (4.6)	Natural	1000	
111-85011	IT50R0C2	IT50R	*	50 lbs (225)	7.99" (203)	1.75" (44.5)	.18" (4.6)	Black	100	
111-85013	IT50R0M4	IT50R	*	50 lbs (225)	7.99" (203)	1.75" (44.5)	.18" (4.6)	Black	1000	
IT50RD Marking Pad Size: 1.14" x 1.04" (46 x 26.3)										
111-85219	IT50RD9K2	IT50RD	MS3368-3-9C	50 lbs (225)	8.07" (205)	1.73" (44.0)	.19" (4.7)	Natural	50	
111-85201	IT50RD0K2	IT50RD	*	50 lbs (225)	8.07" (205)	1.73" (44.0)	.19" (4.7)	Black	50	
IT50RT Marking Pad Size: 1.18" x 1.04" (46 x 26.3)										
111-85119	IT50RT9K2	IT50RT	MS3368-4-9D	50 lbs (225)	8.07" (205)	1.73" (44.0)	.19" (4.7)	Natural	50	
111-85100	IT50RT0K2	IT50RT	*	50 lbs (225)	8.07" (205)	1.73" (44.0)	.19" (4.7)	Black	50	
IT50L Marking Pad Size: .5" x 2.20" (12.8 x 56)										
111-85319	IT50L9C2	IT50L	MS3368-2-9A	50 lbs (225)	15.35" (390)	3.94" (100)	.19" (4.7)	Natural	100	
111-85306	IT50L9M4	IT50L	MS3368-2-9A	50 lbs (225)	15.35" (390)	3.94" (100)	.19" (4.7)	Natural	1000	

Installation tools - MK7, MK7P, MK7HT, MK9. Dimensions are approximate and subject to technical changes. Use **Part No.** for ordering and **Type** for specification purposes. * Military black available. Contact HellermannTyton for more information.

Screw Mount Ties

One-piece, all plastic ties for quick, simple cable mounting.

Material Data	
Material	Polyamide 6.6 (PA66)
Operating Temperature	-40 °F to +185 °F (-40 °C to +85 °C) continuous
Flammability	UL94 V2

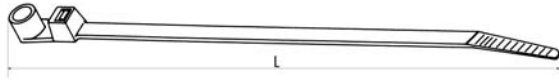

Product Selection

Article No.	Part No.	Type	Mounting	Min. Tensile Strength lbs. (N)	Length (L) in. (mm)	Max. Ø Bundle in. (mm)	Width (W) in. (mm)	Color	Pkg. Qty.
T18MR									
113-00026	T18MR9C2	T18MR	# 4 screw	18 lbs (80)	4.33" (110)	.79" (20)	.10" (2.5)	Natural	100
113-00028	T18MR9M4	T18MR		18 lbs (80)	4.33" (110)	.79" (20)	.10" (2.5)	Natural	1000
113-00022	T18MR0C2	T18MR		18 lbs (80)	4.33" (110)	.79" (20)	.10" (2.5)	Black	100
113-00024	T18MR0M4	T18MR		18 lbs (80)	4.33" (110)	.79" (20)	.10" (2.5)	Black	1000
T30MR									
113-03019	T30MR9C2	T30MR	# 8 screw	30 lbs (135)	6.30" (160)	1.26" (32)	.14" (3.5)	Natural	100
113-00036	T30MR9M4	T30MR		30 lbs (135)	6.30" (160)	1.26" (32)	.14" (3.5)	Natural	1000
113-03010	T30MR0C2	T30MR		30 lbs (135)	6.30" (160)	1.26" (32)	.14" (3.5)	Black	100
113-03011	T30MR0M4	T30MR		30 lbs (135)	6.30" (160)	1.26" (32)	.14" (3.5)	Black	1000
T50MR									
113-05004	T50MR9C2	T50MR	# 10 screw	48 lbs (215)	8.46" (215)	1.77" (45)	.18" (4.6)	Natural	100
113-05007	T50MR9M4	T50MR		48 lbs (215)	8.46" (215)	1.77" (45)	.18" (4.6)	Natural	1000
113-05000	T50MR0C2	T50MR		48 lbs (215)	8.46" (215)	1.77" (45)	.18" (4.6)	Black	100
113-05002	T50MR0M4	T50MR		48 lbs (215)	8.46" (215)	1.77" (45)	.18" (4.6)	Black	1000
T50MRT									
113-05101	T50MRT9C2	T50MRT	#6-32 tap thru screw	50 lbs (225)	8.47" (215)	1.77" (45)	.19" (4.7)	Natural	100
113-05102	T50MRT9M4	T50MRT		50 lbs (225)	8.47" (215)	1.77" (45)	.19" (4.7)	Natural	1000
113-05100	T50MRT0C2	T50MRT		50 lbs (225)	8.47" (215)	1.77" (45)	.19" (4.7)	Black	100
113-00037	T50MRT0M4	T50MRT		50 lbs (225)	8.47" (215)	1.77" (45)	.19" (4.7)	Black	1000
T50MI									
113-00032	T50MI9C2	T50MI	# 10 screw	50 lbs (225)	12.40" (315)	3.35" (85)	.19" (4.7)	Natural	100
113-00033	T50MI9M4	T50MI		50 lbs (225)	12.40" (315)	3.35" (85)	.19" (4.7)	Natural	1000
113-00038	T50MI0C2	T50MI		50 lbs (225)	12.40" (315)	3.35" (85)	.19" (4.7)	Black	100
113-00031	T50MI0M4	T50MI		50 lbs (225)	12.40" (315)	3.35" (85)	.19" (4.7)	Black	1000
T50ML									
113-05419	T50ML9C2	T50ML	# 10 screw	50 lbs (225)	15.35" (390)	4.00" (100)	.18" (4.6)	Natural	100
113-05403	T50ML9M4	T50ML		50 lbs (225)	15.35" (390)	4.00" (100)	.18" (4.6)	Natural	1000
113-00007	T50ML0C2	T50ML		50 lbs (225)	15.35" (390)	4.00" (100)	.18" (4.6)	Black	100
113-00035	T50ML0M4	T50ML		50 lbs (225)	15.35" (390)	4.00" (100)	.18" (4.6)	Black	1000
T120MR									
113-12029	T120MR9K2	T120MR	# 1/4" screw	120 lbs (535)	15.55" (395)	4.02" (102)	.30" (7.6)	Natural	50
113-00018	T120MR9H4	T120MR		120 lbs (535)	15.55" (395)	4.02" (102)	.30" (7.6)	Natural	500
113-12020	T120MR0K2	T120MR		120 lbs (535)	15.55" (395)	4.02" (102)	.30" (7.6)	Black	50
113-00011	T120MR0H4	T120MR		120 lbs (535)	15.55" (395)	4.02" (102)	.30" (7.6)	Black	500

Installation tools - MK7, MK7HT, MK7P, MK9, MK9HT, MK9P. Dimensions are approximate and subject to technical changes. Use **Part No.** for ordering and **Type** for specification purposes.

Cable Ties

Fir Tree Mount and Cable Tie Assemblies

HellermannTyton's fir tree mounts provide a secure grip in a mounting hole and protect against dirt and other impurities. The mount can slide along the strap of the tie for proper orientation. The fir tree mounts are designed to provide a low insertion force and high extraction force. These mounts are sold as an assembly with the cable tie.



Material Data - All Cable Ties/
FT7, FT8 and FT10 Mounts

Material	Polyamide 6.6 heat stabilized (PA66HS)	
Operating Temperature	-40 °F to +221 °F (-40 °C to +105 °C)	
Color	Black	
Flammability	UL94 V2	

Material Data - FT5, FT6 and FT6LG Mounts

Material	Polyamide 6.6 high impact modified, heat stabilized (PA66HIRHS)	
Operating Temperature	-40 °F to +230 °F (-40 °C to +110 °C)	
Color	Black	
Flammability	UL94 HB	

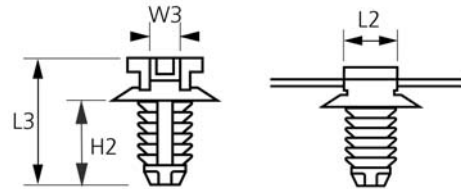
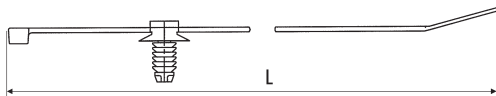

Product Selection

Article No.	Part No.	Type	Min. Tensile Strength lbs. (N)	Max. Ø Bundle in. (mm)	Cable Tie		Mount					Pkg. Qty.
					Length (L) in. (mm)	Width (W) in. (mm)	Disc Ø in. (mm)	Length (L2) in. (mm)	Length (L3) in. (mm)	Width (W3) in. (mm)	Height (H2) in. (mm)	
FT5 - Mounting Hole Ø: .177" - .197" (4.5-5.0mm) - Panel Thickness: .028" - .193" (0.7 - 3.0mm)												
150-55850	150-55850	T30RFT5	30 lbs (135)	1.38" (35)	5.8" (148)	.14" (3.6)	.63" (16.0)	.46" (11.6)	.52" (13.2)	.20" (5)	.27" (6.9)	500
156-00025	156-00025	T50RFT5	50 lbs (225)	1.75" (44.5)	8" (203.2)	.18" (4.6)	.63" (16.0)	.46" (11.6)	.52" (13.2)	.20" (5)	.27" (6.9)	500
FT6 - Mounting Hole Ø: .252" - .28" (6.4-7.1mm) - Panel Thickness: .028" - .193" (0.75 - 3.0mm)												
150-77940	150-77940	T30RFT6	30 lbs (135)	1.38" (35)	5.8" (148)	.14" (3.6)	.63" (16.0)	.46" (11.6)	.54" (13.8)	.20" (5)	.295" (7.5)	500
156-00156	156-00156	T50SFT6	50 lbs (225)	1.38" (35)	6.3" (160)	.18" (4.6)	.63" (16.0)	.46" (11.6)	.54" (13.8)	.20" (5)	.295" (7.5)	500
156-00157	156-00157	T50RFT6	50 lbs (225)	1.75" (44.5)	8" (203.2)	.18" (4.6)	.63" (16.0)	.46" (11.6)	.54" (13.8)	.20" (5)	.295" (7.5)	500
156-00066	156-00066	T50LFT6	50 lbs (225)	4" (101.6)	15" (380)	.18" (4.7)	.63" (16)	.46" (11.6)	.54" (13.8)	.20" (5)	.295" (7.5)	500

Installation tools - MK7, MK7HT, MK7P, MK9, MK9HT, MK9P. Dimensions are approximate and subject to technical changes. Use **Part No.** for ordering and **Type** for specification purposes.

Fir Tree Mount and Cable Tie Assemblies *continued*

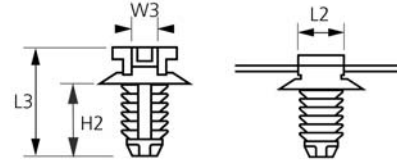
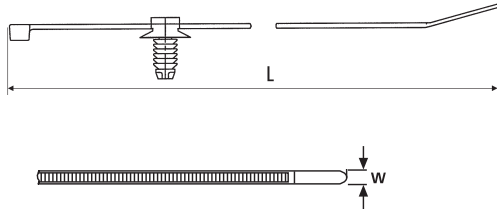

Product Selection												
Article No.	Part No.	Type	Min. Tensile Strength lbs. (N)	Max. Ø Bundle in. (mm)	Cable Tie			Mount				Pkg. Qty.
					Length (L) in. (mm)	Width (W) in. (mm)	Disc Ø in. (mm)	Length (L2) in. (mm)	Length (L3) in. (mm)	Width (W3) in. (mm)	Height (H2) in. (mm)	
FT6LG - Mounting Hole Ø: .256" - .276" (6.4-7.1mm) - Panel Thickness: .03" - .24" (0.75 - 6.0mm)												
150-31090	150-31090	T3ORFT6LG	30 lbs (135)	1.38" (35)	5.8" (148)	.14" (3.6)	.63" (16)	.46" (11.6)	.69" (17.5)	.19" (5)	.44" (11.1)	500
150-31093	150-31093	T5OSFT6LG	50 lbs (225)	1.38" (35)	6.3" (160)	.18" (4.6)	.63" (16)	.46" (11.6)	.69" (17.5)	.19" (5)	.44" (11.1)	500
150-31091	150-31091	T5ORFT6LG	50 lbs (225)	1.75" (44)	8" (203.2)	.18" (4.6)	.63" (16)	.46" (11.6)	.69" (17.5)	.19" (5)	.44" (11.1)	500
156-00054	156-00054	T5OIFT6LG	50 lbs (225)	3.35" (85)	11.8" (300)	.18" (4.6)	.63" (16)	.46" (11.6)	.69" (17.5)	.19" (5)	.44" (11.1)	500
FT7 - Mounting Hole Ø: .256" - .276" (6.5-7.0mm) - Panel Thickness: .031" - .276" (0.8 - 7.0mm)												
156-00057	156-00057	T3ORFT7	30 lbs (135)	1.38" (35)	5.8" (148)	.14" (3.6)	.63" (16)	.46" (11.6)	.75" (19)	.20" (5)	.5" (12.7)	500
156-00056	156-00056	T5OSFT7	50 lbs (225)	1.38" (35)	6.3" (160)	.18" (4.6)	.63" (16)	.46" (11.6)	.75" (19)	.20" (5)	.5" (12.7)	500
111-85871	111-85871	T5ORFT7	50 lbs (225)	1.75" (44)	8" (203.2)	.18" (4.6)	.63" (16)	.46" (11.6)	.75" (19)	.20" (5)	.5" (12.7)	500
111-05350	111-05350	T5OIFT7	50 lbs (225)	3.35" (85)	11.8" (300)	.18" (4.6)	.63" (16)	.46" (11.6)	.75" (19)	.20" (5)	.5" (12.7)	500
156-00055	156-00055	T5OLFT7	50 lbs (225)	4.33" (110)	15" (380)	.18" (4.7)	.63" (16)	.46" (11.6)	.75" (19)	.20" (5)	.5" (12.7)	500
FT8 - Mounting Hole Ø: .3" - .31" (7.7-8.0mm) - Panel Thickness: .03" - .31" (0.8 - 8.0mm)												
156-00058	156-00058	T3ORFT8	30 lbs (135)	1.38" (35)	5.8" (148)	.14" (3.6)	.63" (16)	.47" (12.0)	.7" (17.8)	.35" (9)	.45" (11.5)	500
156-00158	156-00158	T5ORFT8	50 lbs (225)	1.75" (44)	8" (203.2)	.18" (4.6)	.63" (16)	.47" (12.0)	.7" (17.8)	.35" (9)	.45" (11.5)	500
156-00060	156-00060	T5OIFT8	50 lbs (225)	3.35" (81)	11.8" (300)	.18" (4.6)	.63" (16)	.47" (12.0)	.7" (17.8)	.35" (9)	.45" (11.5)	500
156-00061	156-00061	T5OLFT8	50 lbs (225)	4.33" (110)	15" (380)	.18" (4.7)	.63" (16)	.47" (12.0)	.7" (17.8)	.35" (9)	.45" (11.5)	500
FT10 - Mounting Hole Ø: .38" - .39" (9.7-10.0mm) - Panel Thickness: .031" - .236" (0.8 - 5.0mm)												
156-00089	156-00089	T3ORFT10	30 lbs (135)	1.38" (35)	5.8" (148)	.14" (3.6)	.71" (18)	.75" (18.6)	.26" (6.5)	.20" (5)	.48" (12.1)	500
156-00090	156-00090	T5OSFT10	50 lbs (225)	1.38" (35)	6.3" (160)	.18" (4.6)	.71" (18)	.75" (18.6)	.26" (6.5)	.20" (5)	.48" (12.1)	500
156-00091	156-00091	T5ORFT10	50 lbs (225)	1.75" (44)	8" (203.2)	.18" (4.6)	.71" (18)	.75" (18.6)	.26" (6.5)	.20" (5)	.48" (12.1)	500
156-00092	156-00092	T5OIFT10	50 lbs (225)	3.35" (81)	11.8" (300)	.18" (4.6)	.71" (18.0)	.75" (18.6)	.26" (6.5)	.20" (5)	.48" (12.1)	500
156-00093	156-00093	T5OLFT10	50 lbs (225)	4.33" (110)	15" (380)	.18" (4.7)	.71" (18)	.75" (18.6)	.26" (6.5)	.20" (5)	.48" (12.1)	500

Installation tools - MK7, MK7HT, MK7P, MK9, MK9HT, MK9P. Dimensions are approximate and subject to technical changes. Use **Part No.** for ordering and **Type** for specification purposes.

Cable Ties

Fir Tree Push Mount Ties

Fir tree design grips to the inside of a hole. They can be used on sheet metal, wood, and cast iron. Type T50RTM25E has a longer fir tree for larger panel thicknesses.

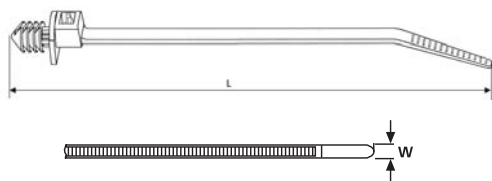

Material Data	
Material	Polyamide 6.6 heat stabilized (PA66HS)
Operating Temperature	-40 °F to +221 °F (-40 °C to +105 °C) continuous
Flammability	UL94 V2



Product Selection			Min. Tensile Strength	Mounting Hole Ø	Panel Thickness	Length (L)	Max. Ø Bundle	Width (W)	Color	Pkg. Qty.
Article No.	Part No.	Type								
126-03501	T50RTM250HSM4	T50RTM25	50 lbs (225)	.25" - .26" (6.5 - 6.6)	.052" - .28" (1.32 - 7.0)	8.27" (210)	1.97" (50.0)	.19" (4.7)	Black	1000
157-01400	T50RTM25E8HSM4	T50RTM25E	50 lbs (225)	.25" - .26" (6.5 - 6.6)	.09" - .55" (2.3 - 13.94)	8.43" (214)	1.97" (50.0)	.19" (4.7)	Gray	1000

Installation tools - MK7, MK7HT, MK7P, MK9, MK9HT, MK9P. Dimensions are approximate and subject to technical changes. Use **Part No.** for ordering and **Type** for specification purposes.

Fir Tree Mount with Disc Tie

This fir tree mount tie provides a low insertion force with a high extraction force. The outside serrations present a smooth surface to the cables preventing damage to the insulation. The unique head design allows the cable tie to firmly hold bundles as small as .06" diameter and the disc offers added water protection.

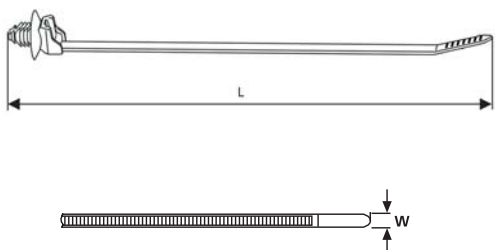

Material Data	
Material	Polyamide 6.6 high impact modified, heat stabilized (PA66HIRHS)
Operating Temperature	-40 °F to +230 °F (-40 °C to +110 °C) continuous
Flammability	UL94 HB



Product Selection			Min. Tensile Strength	Mounting Hole Ø	Panel Thickness	Length (L)	Max. Ø Bundle	Width (W)	Color	Pkg. Qty.
Article No.	Part No.	Type								
155-05800	155-05800	T50SOSFT6E	50 lbs (225)	.26" - .28" (6.5-7.0)	.03" - .12" (0.75 - 3.0)	6.30" (160)	1.38" (35)	.18" (4.6)	Black	500

Installation tools - MK7, MK7HT, MK7P, MK9, MK9HT, MK9P. Dimensions are approximate and subject to technical changes. Use **Part No.** for ordering and **Type** for specification purposes.

Domed Fir Tree Mount

The domed head tie provides a tight, rattle-free installation and the outside serrated strap has ribs designed for convoluted tubing. The dome also acts as a seal to keep out dust and liquid.



Material Data	
Material	Polyamide 6.6 heat stabilized (PA66HS)
Operating Temperature	-40 °F to +221 °F (-40 °C to +105 °C) continuous
Flammability	UL94 V2

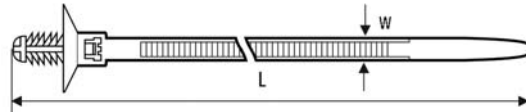

Product Selection												
Article No.	Part No.	Type	Min. Tensile Strength		Mounting Hole Ø	Panel Thickness	Length (L)		Max. Ø Bundle	Width (W)	Color	Pkg. Qty.
			lbs.	(N)	in. (mm)	in. (mm)	in. (mm)	in. (mm)	in. (mm)	in. (mm)		
157-01100	T50SDP6.HB6P	T50SDP6	45 lbs	(200)	.25" - .28" (6.3-7.0)	.03" - .28" (0.8 - 7.0)	6.69" (170)	1.22" (31)	.20" (5.1)	Black	500	

Installation tools - MK7, MK7HT, MK7P, MK9, MK9HT, MK9P. Dimensions are approximate and subject to technical changes. Use **Part No.** for ordering and **Type** for specification purposes.

Domed Push Mount Tie

The domed head tie provides a tight, rattle-free installation and the outside serrated strap has ribs designed for convoluted tubing. The dome also acts as a seal to keep out dust and liquid.



Material Data	
Material	Polyamide 6.6 heat stabilized (PA66HS)
Operating Temperature	-40 °F to +221 °F (-40 °C to +105 °C) continuous
Flammability	UL94 V2

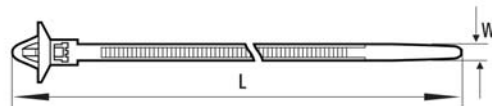

Product Selection												
Article No.	Part No.	Type	Min. Tensile Strength		Mounting Hole Ø	Panel Thickness	Length (L)		Max. Ø Bundle	Width (W)	Color	Pkg. Qty.
			lbs.	(N)	in. (mm)	in. (mm)	in. (mm)	in. (mm)	in. (mm)	in. (mm)		
111-85350	111-85350	T50SD6	50 lbs	(225)	.25" - .30" (6.3-7.5)	.023" - .047" (0.6 - 1.2)	6.30" (160)	1.22" (31)	.20" (5.1)	Black	500	

Installation tools - MK7, MK7HT, MK7P, MK9, MK9HT, MK9P. Dimensions are approximate and subject to technical changes. Use **Part No.** for ordering and **Type** for specification purposes.

Cable Ties

Push Mount Ties

One-piece, all plastic ties for quick, simple cable mounting.



Material Data	
Material	Polyamide 6.6 (PA66)
Operating Temperature	-40 °F to +185 °F (-40 °C to +85 °C) continuous
Flammability	UL94 V2



cru US
File# E64139

Product Selection											
Article No.	Part No.	Type	Min. Tensile Strength		Mounting Hole Ø	Panel Thickness	Length (L)	Max. Ø Bundle	Width (W)	Color	Pkg. Qty.
			lbs.	(N)	in. (mm)	in. (mm)	in. (mm)	in. (mm)	in. (mm)		
T30RSF											
111-85603	T30RSF9C2	T30RSF(U)	30 lbs	(135)	.19" - .22" (4.76-5.59)	.04" - .09" (0.9-2.36)	6.34" (161)	1.25" (31.8)	.14" (3.6)	Natural	100
126-00704	T30RSF9M4	T30RSF(U)	30 lbs	(135)	.19" - .22" (4.76-5.59)	.04" - .09" (0.9-2.36)	6.34" (161)	1.25" (31.8)	.14" (3.6)	Natural	1000
126-00700	T30RSF0C2	T30RSF(U)	30 lbs	(135)	.19" - .22" (4.76-5.59)	.04" - .09" (0.9-2.36)	6.34" (161)	1.25" (31.8)	.14" (3.6)	Black	100
126-00702	T30RSF0M4	T30RSF(U)	30 lbs	(135)	.19" - .22" (4.76-5.59)	.04" - .09" (0.9-2.36)	6.34" (161)	1.25" (31.8)	.14" (3.6)	Black	1000
T50SSF											
126-00043	126-00043	T50SSF	50 lbs	(225)	.25" - .28" (6.4-7.1)	.04" - .14" (1.0-3.56)	6.26" (159)	1.38" (35)	.19" (4.7)	Natural	100
126-00044	126-00044	T50SSF	50 lbs	(225)	.25" - .28" (6.4-7.1)	.04" - .14" (1.0-3.56)	6.26" (159)	1.38" (35)	.19" (4.7)	Natural	1000
126-00045	126-00045	T50SSF	50 lbs	(225)	.25" - .28" (6.4-7.1)	.04" - .14" (1.0-3.56)	6.26" (159)	1.38" (35)	.19" (4.7)	Black	100
126-00046	126-00046	T50SSF	50 lbs	(225)	.25" - .28" (6.4-7.1)	.04" - .14" (1.0-3.56)	6.26" (159)	1.38" (35)	.19" (4.7)	Black	1000
T50RSF											
111-85789	T50RSF9C2	T50RSF(U)	50 lbs	(225)	.25" - .28" (6.4-7.1)	.04" - .14" (1.0-3.56)	8.27" (210)	1.73" (44)	.19" (4.7)	Natural	100
126-01011	T50RSF9M4	T50RSF(U)	50 lbs	(225)	.25" - .28" (6.4-7.1)	.04" - .14" (1.0-3.56)	8.27" (210)	1.73" (44)	.19" (4.7)	Natural	1000
126-01003	T50RSF0C2	T50RSF(U)	50 lbs	(225)	.25" - .28" (6.4-7.1)	.04" - .14" (1.0-3.56)	8.27" (210)	1.73" (44)	.19" (4.7)	Black	100
126-01004	T50RSF0M4	T50RSF(U)	50 lbs	(225)	.25" - .28" (6.4-7.1)	.04" - .14" (1.0-3.56)	8.27" (210)	1.73" (44)	.19" (4.7)	Black	1000

Installation tools - MK7, MK7HT, MK7P, MK9, MK9HT, MK9P. Dimensions are approximate and subject to technical changes. Use **Part No.** for ordering and **Type** for specification purposes.

Wing Push Mount Ties

Wing design helps stabilize the tie in high vibration applications. They can be used on sheet metal, wood, and cast iron.



Material Data	
Material	Polyamide 6.6 (PA66)
Operating Temperature	-40 °F to +185 °F (-40 °C to +85 °C) continuous
Flammability	UL94 V2



Product Selection											
Article No.	Part No.	Type	Min. Tensile Strength	Mounting Hole Ø	Panel Thickness	Length (L)	Max. Ø Bundle	Width (W)	Disc Ø	Color	Pkg. Qty.
			lbs. (N)	in. (mm)	in. (mm)		in. (mm)				
T18RWPM											
126-00041	126-00041	T18RWPM	18 lbs (80)	.19" - .22" (4.76-5.59)	.07" - .13" (1.85 - 3.18)	4.45" (113)	.87" (22)	.10" (2.5)	.52" (13.1)	Natural	100
126-00603	T18RWPM9M4	T18RWPM	18 lbs (80)	.19" - .22" (4.76-5.59)	.07" - .13" (1.85 - 3.18)	4.45" (113)	.87" (22)	.10" (2.5)	.52" (13.1)		1000
T50SL6											
111-85469	T50SL6.NN6P	T50SL6	50 lbs (225)	.24" - .26" (6.1-6.5)	.03" - .10" (0.8 - 2.5)	6.50" (165)	1.34" (34)	.18" (4.6)	.73" (18.5)	Natural	500
T50SL7											
111-85479	T50SL7.NN6P	T50SL7	50 lbs (225)	.27" - .28" (6.9-7.1)	.03" - .10" (0.8 - 2.5)	6.50" (165)	1.34" (34)	.18" (4.6)	.73" (18.5)	Natural	500

Installation tools - MK7, MK7HT, MK7P, MK9, MK9HT, MK9P. Dimensions are approximate and subject to technical changes. Use **Part No.** for ordering and **Type** for specification purposes. * UL recognition applies to T18RWPM ties.

Arrowhead Mount Ties

This tie has an arrowhead design which offers a positive, low insertion force and a high extraction force. Part No. 126-03100 features a foam rubber seal which provides additional protection against moisture, dirt and other impurities.

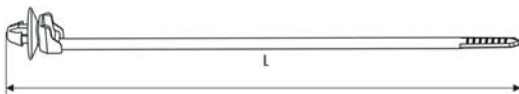

Material Data	
Material	Polyamide 6.6 heat stabilized (PA66HS)
Operating Temperature	-40 °F to +221 °F (-40 °C to +105 °C) continuous
Flammability	UL94 V2

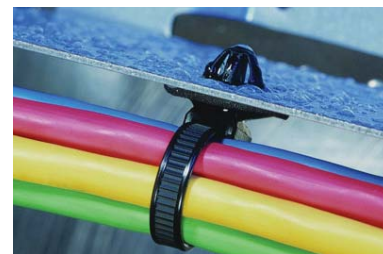

Product Selection											
Article No.	Part No.	Type	Min. Tensile Strength	Mounting Hole Ø	Panel Thickness	Length (L)	Max. Ø Bundle	Width (W)	Color	Pkg. Qty.	
			lbs. (N)	in. (mm)	in. (mm)		in. (mm)				in. (mm)
126-03100	126-03100	T50SOSSFT6.5E-MD	50 lbs (225)	.25" - .26" (6.3-6.7)	.02" - .07" (0.6 - 1.8)	6.30" (160)	1.38" (35)	.18" (4.6)	Green	500	
126-03101	126-03101	T50SOSSFT6.5E	50 lbs (225)	.25" - .26" (6.3-6.7)	.02" - .07" (0.6 - 1.8)	6.30" (160)	1.38" (35)	.18" (4.6)	Black	500	

Installation tools - MK7, MK7HT, MK7P, MK9, MK9HT, MK9P. Dimensions are approximate and subject to technical changes. Use **Part No.** for ordering and **Type** for specification purposes.

Cable Ties

Center Mount, Domed Push Mount Ties

The center mount, domed push mount tie centers the mount on all bundle diameters. The mount is molded in a stationary position for easy assembly. A tab extends beyond the head for easy strap insertion.

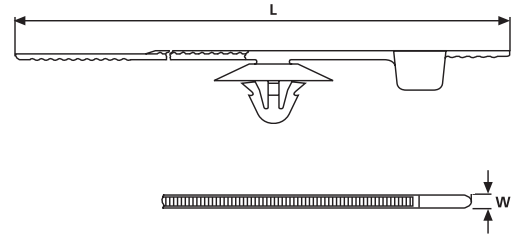

Material Data	
Material	Polyamide 6.6 (PA66)
Operating Temperature	-40 °F to +185 °F (-40 °C to +85 °C) continuous
Flammability	UL94 V2



Product Selection

Article No.	Part No.	Type	Min. Tensile Strength	Mounting Hole Ø	Panel Thickness	Length (L)	Max. Ø Bundle	Width (W)	Color	Pkg. Qty.
			lbs. (N)	in. (mm)	in. (mm)					
150-35930	150-35930	T50RSP	50 lbs (222)	.24" - .26" (6.0-6.5)	.03" - .05" (0.75 - 1.3)	7.48" (190)	1.77" (45)	.18" (4.6)	Black	1000

Installation tools - MK7, MK7HT, MK7P, MK9, MK9HT, MK9P. Dimensions are approximate and subject to technical changes. Use **Part No.** for ordering and **Type** for specification purposes.

Ladder Style Push Mount Ties

The unique ladder style design eliminates the need for various sizes of clamps and allows for easy re-entry to access bundle. Wings on the side of the tie provide stabilization.

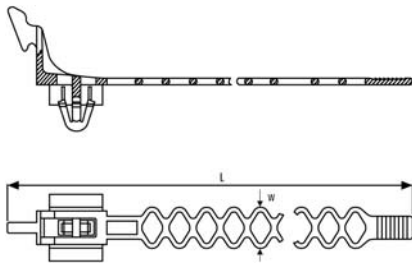

Material Data	
Material	Polyamide 6.6 (PA66)
Operating Temperature	-40 °F to +185 °F (-40 °C to +85 °C) continuous
Flammability	UL94 V2



Product Selection

Article No.	Part No.	Type	Mounting Hole Ø	Panel Thickness	Length (L)	Max. Ø Bundle	Width (W)	Color	Pkg. Qty.
			in. (mm)	in. (mm)					
150-26100	FBS1000H4	FBS100	.25" - .26" (6.3-6.7)	.03" - .15" (0.7 - 3.9)	4.53" (115)	1.06" (27)	.40" (10)	Black	500
150-26140	FBS1400H4	FBS140	.26" - .25" (6.3-6.7)	.03" - .15" (0.7 - 3.9)	6.30" (160)	1.65" (42)	.40" (10)	Black	500
150-26180	FBS1850H4	FBS185	.26" - .25" (6.3-6.7)	.03" - .15" (0.7 - 3.9)	7.87" (200)	2.09" (53)	.40" (10)	Black	500

Installation tools - MK7, MK7HT, MK7P, MK9, MK9HT, MK9P. Dimensions are approximate and subject to technical changes. Use **Part No.** for ordering and **Type** for specification purposes.

Wide Strap Heavy Duty Stud Mount Cable Ties

The wide strap stud mount cable tie minimizes pinching on soft bundles and features a low profile head to provide compact bundling. A thinner strap provides increased flexibility for improved ergonomics. Available with a 1/4" and 3/8" stud mount, the wide strap tie utilizes a strong hinge between the stud mount and head to provide superior holding ability on a threaded stud.

- Wide strap to minimize pinching of soft hoses and convoluted tubing
- Clamping rails to increase grip on round bundles
- Wide variation of bundle diameters: .375" - 4.125" (9.5mm - 104.7mm)
- Flexible strap
- Flexible hinge
- Mount provides low insertion and high extraction forces

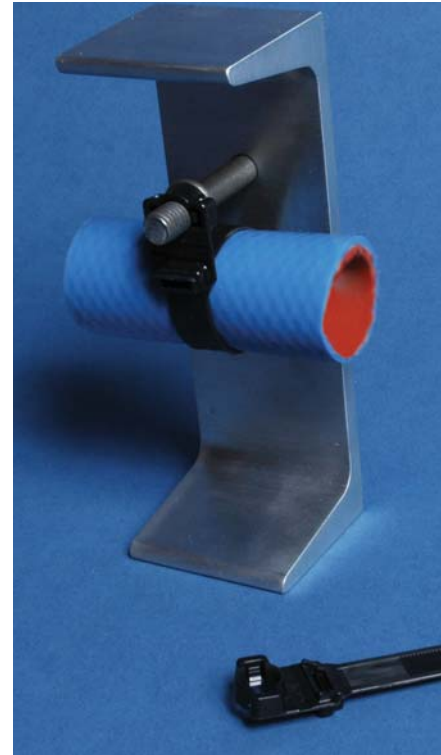

Material Data		RoHS	
Material	Polyamide 6.6 high impact modified, heat stabilized (PA66HIRHS)		
Operating Temperature	-40 °F to +230 °F (-40 °C to +110 °C) continuous		
Flammability	UL94 HB		

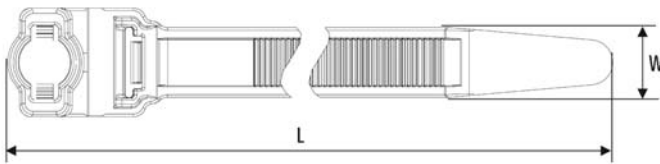

Product Selection			Min. Tensile Strength	Length (L)	Max. Ø Bundle	Width (W)	Color	Pkg. Qty.
Article No.	Part No.	Type						
Wide Strap Ties with 1/4" Stud Mount								
157-00400	157-00400	WSS250	120 lbs (534)	9.7" (246.38)	2.25" (57.15)	.5" (12.7)	Black	300
157-00401	157-00401	WSI250	120 lbs (534)	12.7" (322.58)	3.25" (82.55)	.5" (12.7)	Black	300
157-00402	157-00402	WSR250	120 lbs (534)	15.7" (398.78)	4.125" (104.78)	.5" (12.7)	Black	300
Wide Strap Ties with 3/8" Stud Mount								
WSS38								
157-00406	157-00406	WSS380	120 lbs (534)	9.7" (246.38)	2.25" (57.15)	.5" (12.7)	Black	60
157-00403	157-00403	WSS380	120 lbs (534)	9.7" (246.38)	2.25" (57.15)	.5" (12.7)	Black	300
WSI38								
157-00407	157-00407	WSI380	120 lbs (534)	12.7" (322.58)	3.25" (82.55)	.5" (12.7)	Black	60
157-00404	157-00404	WSI380	120 lbs (534)	12.7" (322.58)	3.25" (82.55)	.5" (12.7)	Black	300
WSR38								
157-00408	157-00408	WSR380	120 lbs (534)	15.7" (398.78)	4.125" (104.78)	.5" (12.7)	Black	60
157-00405	157-00405	WSR380	120 lbs (534)	15.7" (398.78)	4.125" (104.78)	.5" (12.7)	Black	300

Installation tools - MK9, MK9HT, MK9P. Dimensions are approximate and subject to technical changes. Use **Part No.** for ordering and **Type** for specification purposes.

Cable Ties

Stud Mount Ties

The stud mount tie mounts and secures a cable bundle in one component. The stud mount tie is designed for use on a 1/4" - 20 UNC threaded stud or the exposed threads of a machine screw.

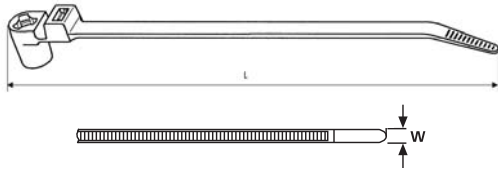

Material Data		RoHS
Material	Polyamide 6.6 high impact modified, heat stabilized (PA66HIRHS)	
Operating Temperature	-40 °F to +230 °F (-40 °C to +110 °C) continuous	
Flammability	UL94 HB	

Product Selection			Stud Ø	Min. Tensile Strength	Length (L)	Max. Ø Bundle	Width (W)	Color	Pkg. Qty.
Article No.	Part No.	Type							
157-01300	T120RSM0HIRK2	T120RSM	.25" (6.25)	120 lbs (535)	15.94" (405)	3.98" (101)	.30" (7.6)	Black	50

Installation tools - MK9, MK9HT, MK9P. Dimensions are approximate and subject to technical changes. Use **Part No.** for ordering and **Type** for specification purposes.

Standoff Stud Mount Tie

This tie is easily mounted on the top of the stud, the additional height gained by this design gives the bundle added clearance from the panel.



Material Data		RoHS
Material	Polyamide 6.6 heat stabilized (PA66HS)	
Operating Temperature	-40 °F to +221 °F (-40 °C to +105 °C) continuous	
Flammability	UL94 V2	

Product Selection			Stud Ø	Min. Tensile Strength	Length (L)	Max. Ø Bundle	Width (W)	Color	Pkg. Qty.
Article No.	Part No.	Type							
155-30602	155-30602	T50SSBS50TE	.20" (5)	45 lbs (200)	6.30" (160)	1.38" (35)	.181" (4.6)	Black	500

Installation tools - MK7, MK7HT, MK7P, MK9, MK9HT, MK9P. Dimensions are approximate and subject to technical changes. Use **Part No.** for ordering and **Type** for specification purposes.

Oval Shaped Variable Stud Mount Ties

The special oval shape provides for an approximate .20" (5.5mm) lateral adjustment, allowing for any misalignment of the stud or incorrect positioning of the tie on the cables. The "soft push" mount allows it to be installed onto a weld stud without the use of any tools.

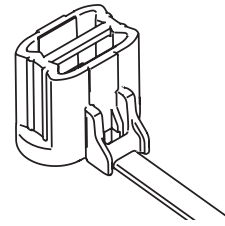

T50SOSSB5HEC



T50SOSSB6HE

Material Data	
Material	Polyamide 6.6 heat stabilized (PA66HS)
Operating Temperature	-40 °F to +221 °F (-40 °C to +105 °C) continuous
Flammability	UL94 V2



Product Selection		Type	Stud Ø		Min. Tensile Strength		Length (L)		Max. Ø Bundle		Width (W)		Color	Pkg. Qty.
Article No.	Part No.		in.	(mm)	lbs.	(N)	in.	(mm)	in.	(mm)	in.	(mm)		
155-05400	155-05400	T50SOSSB5HEC	.20"	(5)	38 lbs	(170)	6.30"	(160)	1.38"	(35)	.18"	(4.6)	Black	500
155-46302	155-46302	T50SOSSB6HE	.24"	(6)	38 lbs	(170)	6.30"	(160)	1.38"	(35)	.18"	(4.6)	Black	500

Installation tools - MK7, MK7HT, MK7P, MK9, MK9HT, MK9P. Dimensions are approximate and subject to technical changes. Use **Part No.** for ordering and **Type** for specification purposes.

Stud Mount Tie with Outside Serrations

Providing an especially secure hold and the ability to mount the cables very close to the stud, this tie is outside serrated preventing damage to the insulation of the cable.

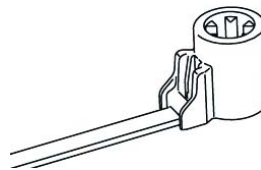

T50SOSSB5SE

Material Data	
Material	Polyamide 6.6 heat stabilized (PA66HS)
Operating Temperature	-40 °F to +221 °F (-40 °C to +105 °C) continuous
Flammability	UL94 V2



Product Selection		Type	Stud Ø		Min. Tensile Strength		Length (L)		Max. Ø Bundle		Width (W)		Color	Pkg. Qty.
Article No.	Part No.		in.	(mm)	lbs.	(N)	in.	(mm)	in.	(mm)	in.	(mm)		
155-12300	155-12300	T50SOSSB5SE	.20"	(5)	50 lbs	(225)	6.30"	(160)	1.38"	(35)	.18"	(4.6)	Black	500

Installation tools - MK7, MK7HT, MK7P, MK9, MK9HT, MK9P. Dimensions are approximate and subject to technical changes. Use **Part No.** for ordering and **Type** for specification purposes.

Cable Ties

Ladder Style Stud Mount Ties

Ladder style tie mounts easily onto #10-24" (5 mm) stud. Unique latch allows for easy re-entry to bundles.

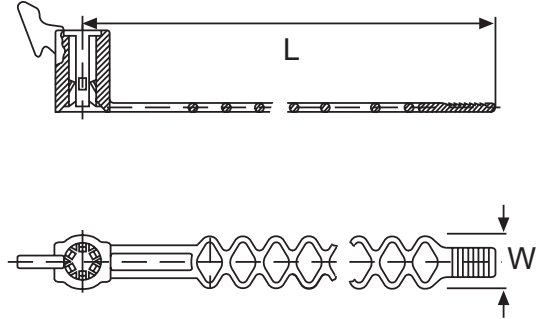
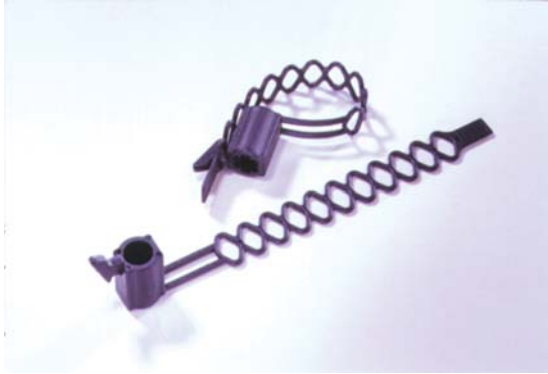

Material Data	
Material	Polyamide 6.6 (PA66)
Operating Temperature	-40 °F to +185 °F (-40 °C to +85 °C) continuous
Flammability	UL94 V2



Product Selection			Stud Ø	Length (L)	Max. Ø Bundle	Width (W)	Color	Pkg. Qty.
Article No.	Part No.	Type						
150-28100	150-28100	FBB100	# 10-24" (5)	4" (110)	.91" (23)	.40" (10)	Black	500
150-28140	150-28140	FBB140		5.59" (142)	1.50" (38)	.40" (10)	Black	500
150-28180	150-28180	FBB185		7.87" (200)	1.97" (50)	.40" (10)	Black	500

Dimensions are approximate and subject to technical changes. Use **Part No.** for ordering and **Type** for specification purposes.

Flexible Head Stud Mount Tie

Flexible head wraps around cable bundle for easy installation.

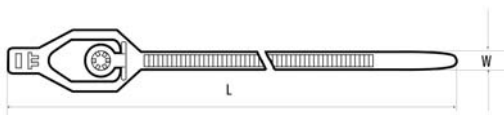

Material Data	
Material	Polyamide 6.6 (PA66)
Operating Temperature	-40 °F to +185 °F (-40 °C to +85 °C) continuous
Flammability	UL94 V2



Product Selection			Stud Ø	Min. Tensile Strength	Length (L)	Max. Ø Bundle	Width (W)	Color	Pkg. Qty.
Article No.	Part No.	Type							
111-07110	111-07110	T5ORS5	#10 - 24" (5)	50 lbs (225)	7.48" (190)	1.58" (40)	.18" (4.6)	Black	100

Dimensions are approximate and subject to technical changes. Use **Part No.** for ordering and **Type** for specification purposes.

Cable Ties and Edge Clips

HellermannTyton's edge clips are designed specifically to route bundles by securing them to the edge of a plastic or metal sheet without the need for a mounting hole. The clip is easy to secure and the extraction force is high due to the integrated metal clamp that holds the edge clip in place. Edge clips are available in three configurations: a two piece clip and tie assembly, a one piece clip and tie combination and a edge clip and tape bar combination. When noted (*), cable ties are outside serrated which can reduce bundle chafing.

Two Piece Edge Clip and Cable Tie Assemblies

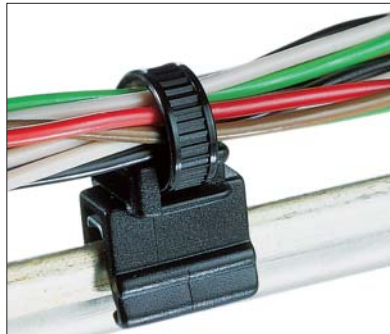

T50ROSEC4A - the cable bundle runs parallel with the edge.

Material Data- Cable Tie		RoHS
Material	Polyamide 6.6 heat stabilized (PA66HS)	
Color	Black	
Operating Temperature	-40 °F to +221 °F (-40 °C to +105 °C) continuous	
Flammability	UL94 V2	

Material Data - Edge Clip		RoHS
Material	Polyamide 6.6 high impact modified, heat stabilized (PA66HIRHS)	
Color	Black	
Operating Temperature	-40 °F to +230 °F (-40 °C to +110 °C) continuous	
Flammability	UL94 HB	

Product Selection							Pkg. Qty.	Drawing
Article No.	Part No.	Type	Min. Tensile Strength	Length (L)	Max. Ø Bundle			
			lbs. (N)	in. (mm)	in. (mm)			
Panel Thickness, — .039" - .117" (1-3mm)								
150-76090	150-76090	T30REC4A	30 lbs (135)	5.9" (150)	1.3" (33)	500		
150-76093	150-76093 *	T50SOSEC4A	50 lbs (225)	5.9" (150)	1.2" (31)	500		
150-76091	150-76091	T50REC4A	50 lbs (225)	8" (202)	1.8" (45)	500		
150-76099	150-76099 *	T50ROSEC4A	50 lbs (225)	7.9" (200)	1.8" (45)	500		
150-76080	150-76080	T30REC4B	50 lbs (135)	5.9" (150)	1.3" (33)	500		
156-00109	156-00109 *	T50SOSEC4B	50 lbs (225)	6.5" (165)	1.2" (31)	500		
150-76079	150-76079 *	T50ROSEC4B	50 lbs (225)	7.9" (200)	1.8" (45)	500		
150-40593	150-40593 *	T50SOSEC5A	50 lbs (225)	5.9" (150)	1.2" (31)	500		
150-40592	150-40592	T50REC5A	50 lbs (225)	8" (202)	1.8" (45)	500		
150-40591	150-40591	T50ROSEC5A	50 lbs (225)	7.9" (200)	1.8" (45)	500		
156-01007	156-01007	T50RDHEC5A	50 lbs (225)	8.3" (210)	1.8" (45)	500		
156-05000	156-05000	T30REC5B	30 lbs (135)	5.9" (150)	1.3" (33)	500		
150-40583	150-40583 *	T50SOSEC5B	50 lbs (225)	5.9" (150)	1.2" (31)	500		
150-40582	150-40582	T50REC5B	50 lbs (225)	8.0" (202)	1.8" (45)	500		
150-40581	150-40581 *	T50ROSEC5B	50 lbs (225)	7.9" (200)	1.8" (45)	500		
155-37104	155-37104	T18REC9	18 lbs (80)	3.9" (100)	.75" (19)	500		
156-00019	156-00019 *	T50SOSEC9SD	50 lbs (225)	5.9" (150)	1.2" (31)	500		
156-05903	156-05903	T50ROSEC9	50 lbs (225)	7.9" (200)	1.8" (45)	500		
155-38304	155-38304	T18R-EC10	18 lbs (80)	3.9" (100)	.79" (20)	500		
156-05904	156-05904 *	T50ROSEC10	50 lbs (225)	7.9" (200)	1.8" (45)	500		
156-00017	156-00017	T50SOSEC21	50 lbs (225)	5.9" (150)	1.3" (33)	500		
156-00010	156-00010	T50ROSEC21	50 lbs (225)	7.9" (200)	1.8" (45)	500		
156-00018	156-00018	T50SOSEC22	50 lbs (225)	5.9" (150)	1.3" (33)	500		
156-00011	156-00011	T50ROSEC22	50 lbs (225)	7.9" (200)	1.8" (45)	500		

Installation tools - MK7, MK7HT, MK7P, MK9, MK9HT, MK9P. * outside serrated cable tie

Dimensions are approximate and subject to technical changes. Use **Part No.** for ordering and **Type** for specification purposes.

Two Piece Edge Clip and Cable Tie Assemblies *continued*

Product Selection			Min. Tensile Strength		Length (L)		Max. Ø Bundle		Pkg. Qty.	Drawing
Article No.	Part No.	Type	lbs.	(N)	in.	(mm)	in.	(mm)		
Panel Thickness — .117" - .234" (3-6 mm)										
156-04600	156-04600	T18ROSEC19	18 lbs	(80)	3.9"	(100)	.79"	(20)	500	
156-04601	156-04601	T50SOSEC19	50 lbs	(225)	5.9"	(150)	1.2"	(31)	500	
156-04602	156-04602	T50ROSEC19	50 lbs	(225)	7.9"	(200)	1.8"	(45)	500	
156-00016	156-00016	T50SOSEC20	50 lbs	(225)	5.9"	(150)	1.3"	(33)	500	
156-00020	156-00020	T50ROSEC20	50 lbs	(225)	7.9"	(200)	1.8"	(45)	500	
156-00006	156-00006	T50ROSEC23	50 lbs	(225)	7.9"	(200)	1.8"	(45)	500	
156-00007	156-00007	T50ROSEC24	50 lbs	(225)	7.9"	(200)	1.8"	(45)	500	

Installation tools - MK7, MK7HT, MK7P, MK9, MK9HT, MK9P.

Dimensions are approximate and subject to technical changes. Use **Part No.** for ordering and **Type** for specification purposes.

One Piece Edge Clip and Cable Tie Combinations

The plastic area of the edge clips and the cable ties are molded together.

Material Data	
Material	Polyamide 6.6 heat stabilized (PA66HS)
Color	Black
Operating Temperature	-40 °F to +221 °F (-40 °C to +105 °C) continuous
Flammability	UL94 HB



Product Selection			Min. Tensile Strength		Length (L)		Max. Ø Bundle		Pkg. Qty.	Drawing
Article No.	Part No.	Type	lbs.	(N)	in.	(mm)	in.	(mm)		
Panel Thickness — .039" - .117" (1-3 mm)										
133-00059	133-00059	T40XEC5SP-E	40 lbs	(178)	4.05"	(103)	.59"	(15)	500	
148-00200	148-00200	T50SOSEC12E	50 lbs	(225)	6.30"	(160)	1.38"	(35)	500	
126-00000	126-00000	T50SOSEC13E	50 lbs	(225)	6.30"	(160)	1.38"	(35)	500	

Installation tools - MK7, MK7HT, MK7P, MK9, MK9HT, MK9P. Dimensions are approximate and subject to technical changes. Use **Part No.** for ordering and **Type** for specification purposes.

Edge Clip and Tape Clip Combination

These clips can be secured to cables with cable ties or tape.

Material Data - Cable Tie and Tape Clip Combination



Material	Polyamide 6.6 high impact modified, heat stabilized (PA66HIRHS)
Color	Black
Operating Temperature	-40 °F to +230 °F (-40 °C to +110 °C) continuous
Flammability	UL94 HB

Product Selection

Article No.	Part No.	Type	Length (L)		Width (W)		Pkg. Qty.	Drawing
			in.	(mm)	in.	(mm)		
Panel Thickness — .039" - .117" (1-3 mm)								
151-03404	151-03404	EC14	1.57"	(40.0)	.39"	(10.0)	500	
151-03401	151-03401	EC15	1.57"	(40.0)	.39"	(10.0)	500	
151-03402	151-03402	EC16	1.57"	(40.0)	.39"	(10.0)	500	
151-03403	151-03403	EC17	1.57"	(40.0)	.39"	(10.0)	500	

Dimensions are approximate and subject to technical changes. Use **Part No.** for ordering and **Type** for specification purposes.

Cable Ties

Button Head Ties

The button head tie is a two piece tie providing for parallel entry and exit through the head. The strap contains serrations on both sides and has two opposed pawls recessed within a domed head.

This design allows the strap to be directed clockwise or counter-clockwise prior to insertion into the head, enabling bi-directional looping.



New and Improved Features

The button head tie offers many new and improved features for added durability and installation ease.

Standoff tabs — prevent tie head from seating in button during strap insertion

Pilot bushing - protects the strap from abrasion on the mounting hole edge

Ribs - increased ribs added to the bottom of the button head for added durability

Strap - more radiused edges for added flexibility

Serrations - redesigned serrations and wedge design provide optimal strength when seated in the head

Retainers — lower retainers on BT130 help prevent the strap from backing out of the mounting hole and holds HellermannTyton's saddle mounts in place during assembly.

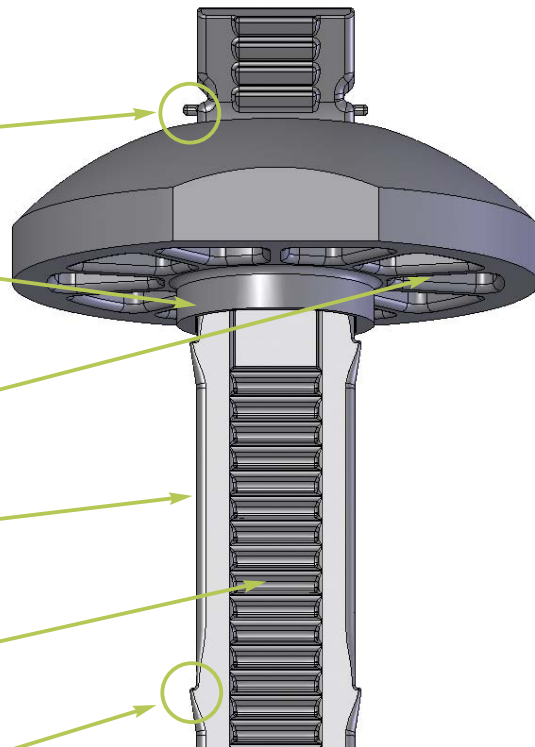

Button Head Ties *continued*

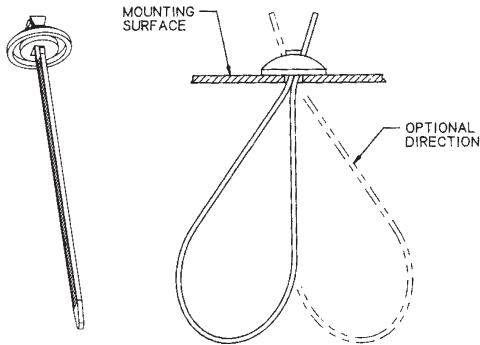

Material Data	
Cable Tie Material	Polyamide 6.6 high impact modified, heat stabilized (PA66HIRHS)
Button Head Material	Polyamide 6.6 heat stabilized (PA66HS)
Operating Temperature	-40 °F to +221 °F (-40 °C to +105 °C) continuous
Color	Black
Flammability	UL94 HB

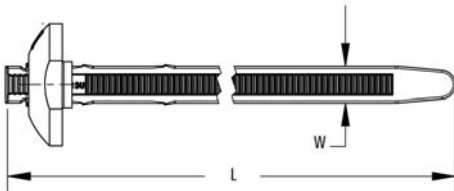

Product Selection												
Article No.	Part No.	Type	Min. Tensile Strength		Length (L)		Max. Ø Bundle		Width (W)		Color	Pkg. Qty.
			lbs.	(N)	in.	(mm)	in.	(mm)	in.	(mm)		
BT105 Button Head Ties												
132-00010	132-00010	BT105R	105 lbs	(467)	9.63"	(244.4)	2.62"	(66.7)	.22"	(5.6)	Black	50
132-00011	132-00011	BT105L	105 lbs	(467)	15"	(381.5)	4.33"	(110)	.22"	(5.6)	Black	50
BT105 Button Head Ties with Pilot Bushings												
132-00006	132-00006	BT105RP	105 lbs	(467)	9.63"	(244.4)	2.62"	(66.7)	.22"	(5.6)	Black	50
132-00007	132-00007	BT105LP	105 lbs	(467)	15"	(381.5)	4.33"	(110)	.22"	(5.6)	Black	50
BT130 Button Head Ties with Retainers and Pilot Bushings												
132-00008	132-00008	BT130RDP	130 lbs	(578)	10.51"	(267.0)	2.87"	(73)	.30"	(7.6)	Black	50
132-00009	132-00009	BT130LDP	130 lbs	(578)	15"	(381.5)	4.33"	(110)	.30"	(7.6)	Black	50

Installation tools - MK9, MK9HT, MK9P. Dimensions are approximate and subject to technical changes. Use **Part No.** for ordering and **Type** for specification purposes.

Cable Ties

EL-TY (Extended Length Ties)

HellermannTyton's El-Ty is a high strength strapping system used for supporting, securing, fastening, and spacing cables, as well as a variety of other applications requiring extra-long, extremely durable strapping.

The El-Ty consists of a smooth strap and a separate, compact plastic head which encloses a stainless steel gripper. The stackable spacer accepts cable ties up to 1/2" wide for a versatile, easy to install spacing system.



Material Data- Strap and Head	
Material	Polyacetal (POM)
Color	Black
Operating Temperature	-40 °F to +185 °F (-40 °C to +85 °C)
Flammability	UL94 HB

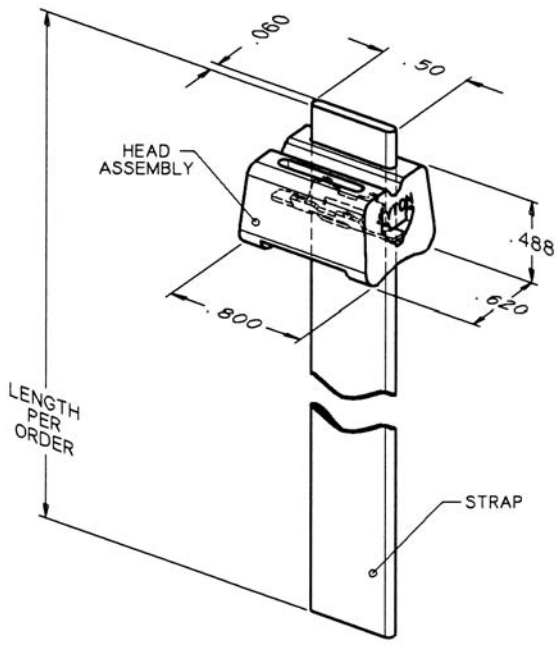

El-Ty Strap and Locking Head

Material Data- Spacer	
Material	Polypropylene, UV-resistant (PP)
Color	Black
Operating Temperature	-40 °F to +239 °F (-40 °C to +115 °C) continuous
Flammability	UL94 HB

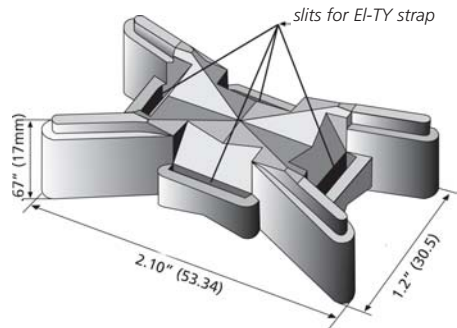

El-Ty Spacer

Product Selection

Article No.	Part No.	Type	Description	Color	Pkg. Qty.
111-30000	TELS-1	TELS1	1 - 50 ft reel of strap and 30 heads	Black	1
111-31000	TELS-H	TELSH	Double entry and locking heads	Black	25
111-32108	TELS-13	TELS-13	10 - 13.5" straps and 10 double locking heads	Black	1
111-32110	TELS-27	TELS-27	10 - 27" straps and 10 double locking heads	Black	1
111-32111	TELS-5K	TELS-5K	5 - 50 ft. reels and 150 heads	Black	1
111-32107	TELS-10K	TELS-10K	10 - 50 ft. reels and 300 heads	Black	1
111-32000	TELS-SPK2	TELS-SPK2	EL-TY Spacer	Black	50
111-32106	TELS-SPOOL	TELS-SPOOL	50 ft. reel of strap	Black	1

Dimensions are approximate and subject to technical changes. Use **Part No.** for ordering and **Type** for specification purposes.

Aerial Support Spacer Ties

Aerial support spacer ties are two piece ties designed for standard spacing applications. The strap is molded from special high impact polyamide 6.6. The support spacer and head are made from a high density outdoor black polypropylene. Both materials offer resistance to sunlight, saltwater, and harsh chemical environments.

Material Data- Strap	
Material	Polyamide 6.6 high impact modified (PA66HIR)
Color	Black
Operating Temperature	-40 °F to +230 °F (-40 °C to +110 °C) continuous
Flammability	UL94 HB



Material Data-Spacer/Head	
Material	Polypropylene, UV-resistant (PP)
Color	Black
Operating Temperature	-40 °F to +239 °F (-40 °C to +115 °C) continuous
Flammability	UL94 HB

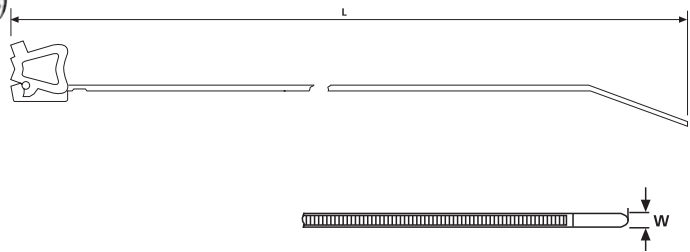

Product Selection

Article No.	Part No.	Type	Min. Tensile Strength		Length (L)		Max. Ø Bundle		Width (W)		Color	Pkg. Qty.
			lbs.	(N)	in.	(mm)	in.	(mm)	in.	(mm)		
111-98501	TAS100RWS	TAS100RWS	100 lbs	(445)	8.25"	(209.6)	1.75"	(44.5)	.50"	(12.7)	Black	100
111-98500	TAS100MWS	TAS100MWS	100 lbs	(445)	10.7"	(272.3)	2.75"	(70)	.50"	(12.7)	Black	100
148-00022	TAS100LWS	TAS100LWS	100 lbs	(445)	16"	(420)	4.5"	(115)	.50"	(12.7)	Black	100

Dimensions are approximate and subject to technical changes. Use **Part No.** for ordering and **Type** for specification purposes.
 Installation tools - MK9, MK9HT, MK9P.

Kabelrap Bundling System

The patented Kabelrap bundling system offers a very high bundling strength and is particularly resistant to salt water, oils, greases, and hydraulic fluids. Special hand tool required for installation.



Required Tool - 121-00680



Kabelrap Application

Material Data	
Material	Polyamide 6.6 UV-resistant (PA66UV)
Operating Temperature	-40 °F to +185 °F (-40 °C to +85 °C) continuous
Flammability	UL94 V2

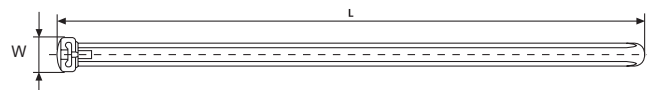

Product Selection

Article No.	Part No.	Type	Min. Tensile Strength		Length (L)		Max. Ø Bundle		Width (W)		Color	Pkg. Qty.
			lbs.	(N)	in.	(mm)	in.	(mm)	in.	(mm)		
121-61860	121-61860	KR6/18	110 lbs	(490)	7.25"	(183)	1.5"	(39)	.24"	(6)	Black	50
121-63560	121-63560	KR6/35	110 lbs	(490)	14"	(356)	3.75"	(93)	.25"	(6)	Black	50
121-82160	121-82160	KR8/21	175 lbs	(785)	8.25"	(210)	1.75"	(47)	.31"	(8)	Black	50
121-83360	121-83360	KR8/33	175 lbs	(785)	13.25"	(337)	3.37"	(86)	.31"	(8)	Black	50

Required Installation Tool - 121-00680. Black is the standard color. Natural is available based upon minimums, custom terms and lead times.

Dimensions are approximate and subject to technical changes. Use **Part No.** for ordering and **Type** for specification purposes.

Cable Ties

Parallel Entry Ties

The parallel entry tie features a very low profile head, which enables the installed tie to lie flat on the bundle. Its sleek design enhances safety and fulfills the requirements of many diverse applications. The parallel entry tie features outside serrations to allow the smooth side of the tie to rest on a bundle, reducing any potential of wear due to abrasion from vibrations or movement. The parallel entry tie also offers an optional custom designed feature for foam applications, such as playground equipment. With child safety in mind, the patented retainer bumps on the strap allow the tie to grip into foam padded equipment eliminating slippage. The retainers also contain the tail of the tie eliminating the need to cut any excess material. This feature eliminates the potential for any sharp edges. Only a smooth surface is evident. The "PER" designation in the part number indicates the retainer feature.



Retainer (PER) Version

Material Data	
Material	Polyamide 6.6 UV-resistant (PA66UV)
Operating Temperature	-40 °F to +185 °F (-40 °C to +85 °C) continuous
Flammability	UL94 V2

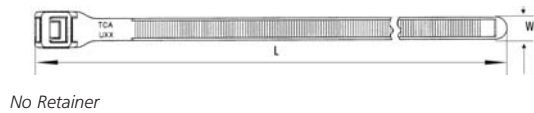
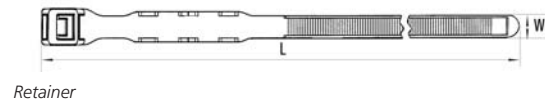

Product Selection			Min. Tensile Strength	Length (L)	Max. Ø Bundle	Width (W)	Color	Pkg. Qty.
Article No.	Part No.	Type						
PE130S								
112-00700	PE130S0UVC2	PE130S	130 lbs (578.3)	13.5" (342.9)	4.0" (101.6)	.36" (9.1)	Black	100
112-00701	PE130S14UVC2	PE130S	130 lbs (578.3)	13.5" (342.9)	4.0" (101.6)	.36" (9.1)	Watermelon	100
112-00702	PE130S20UVC2	PE130S	130 lbs (578.3)	13.5" (342.9)	4.0" (101.6)	.36" (9.1)	Custom Blue	100
112-00703	PE130S22UVC2	PE130S	130 lbs (578.3)	13.5" (342.9)	4.0" (101.6)	.36" (9.1)	Lavender	100
112-00704	PE130S23UVC2	PE130S	130 lbs (578.3)	13.5" (342.9)	4.0" (101.6)	.36" (9.1)	Raspberry	100
112-00705	PE130S35UVC2	PE130S	130 lbs (578.3)	13.5" (342.9)	4.0" (101.6)	.36" (9.1)	Candy	100
112-00706	PE130S36UVC2	PE130S	130 lbs (578.3)	13.5" (342.9)	4.0" (101.6)	.36" (9.1)	Caramel	100
112-00707	PE130S37UVC2	PE130S	130 lbs (578.3)	13.5" (342.9)	4.0" (101.6)	.36" (9.1)	Cobalt Blue	100
112-00708	PE130S38UVC2	PE130S	130 lbs (578.3)	13.5" (342.9)	4.0" (101.6)	.36" (9.1)	Forest Green	100
112-00709	PE130S39UVC2	PE130S	130 lbs (578.3)	13.5" (342.9)	4.0" (101.6)	.36" (9.1)	Grape	100
112-00710	PE130S40UVC2	PE130S	130 lbs (578.3)	13.5" (342.9)	4.0" (101.6)	.36" (9.1)	Rose Pink	100
112-00711	PE130S41UVC2	PE130S	130 lbs (578.3)	13.5" (342.9)	4.0" (101.6)	.36" (9.1)	Lemon Yellow	100
112-00712	PE130S42UVC2	PE130S	130 lbs (578.3)	13.5" (342.9)	4.0" (101.6)	.36" (9.1)	Sky Blue	100
112-00713	PE130S43UVC2	PE130S	130 lbs (578.3)	13.5" (342.9)	4.0" (101.6)	.36" (9.1)	Charcoal	100
112-00714	PE130S4UVC2	PE130S	130 lbs (578.3)	13.5" (342.9)	4.0" (101.6)	.36" (9.1)	Yellow	100

Installation tools - MK9, MK9HT, MK9P. Dimensions are approximate and subject to technical changes. Use **Part No.** for ordering and **Type** for specification purposes.

Parallel Entry Ties *continued*

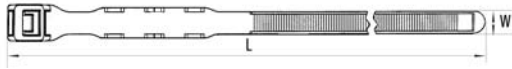

Retainer

Material Data	
Material	Polyamide 6.6 UV-resistant (PA66UV)
Operating Temperature	-40 °F to +185 °F (-40 °C to +85 °C) continuous
Flammability	UL94 V2



No Retainer

Product Selection			Min. Tensile Strength	Length (L)	Max. Ø Bundle	Width (W)	Color	Pkg. Qty.
Article No.	Part No.	Type						
PE130R								
112-00600	PE130R0UVC2	PE130R	130 lbs (578.3)	16.25" (413.0)	4.84" (123.0)	.36" (9.0)	Black	100
112-00601	PE130R14UVC2	PE130R	130 lbs (578.3)	16.25" (413.0)	4.84" (123.0)	.36" (9.0)	Watermelon	100
112-00602	PE130R17UVC2	PE130R	130 lbs (578.3)	16.25" (413.0)	4.84" (123.0)	.36" (9.0)	Tan	100
112-00603	PE130R1AUVC2	PE130R	130 lbs (578.3)	16.25" (413.0)	4.84" (123.0)	.36" (9.0)	Chocolate	100
112-00604	PE130R20UVC2	PE130R	130 lbs (578.3)	16.25" (413.0)	4.84" (123.0)	.36" (9.0)	Custom Blue	100
112-00605	PE130R21UVC2	PE130R	130 lbs (578.3)	16.25" (413.0)	4.84" (123.0)	.36" (9.0)	Custom Green	100
112-00606	PE130R22UVC2	PE130R	130 lbs (578.3)	16.25" (413.0)	4.84" (123.0)	.36" (9.0)	Lavender	100
112-00607	PE130R23UVC2	PE130R	130 lbs (578.3)	16.25" (413.0)	4.84" (123.0)	.36" (9.0)	Raspberry	100
112-00608	PE130R31UVC2	PE130R	130 lbs (578.3)	16.25" (413.0)	4.84" (123.0)	.36" (9.0)	Aquamarine	100
112-00609	PE130R35UVC2	PE130R	130 lbs (578.3)	16.25" (413.0)	4.84" (123.0)	.36" (9.0)	Candy	100
112-00610	PE130R36UVC2	PE130R	130 lbs (578.3)	16.25" (413.0)	4.84" (123.0)	.36" (9.0)	Caramel	100
112-00611	PE130R37UVC2	PE130R	130 lbs (578.3)	16.25" (413.0)	4.84" (123.0)	.36" (9.0)	Cobalt Blue	100
112-00612	PE130R38UVC2	PE130R	130 lbs (578.3)	16.25" (413.0)	4.84" (123.0)	.36" (9.0)	Forest Green	100
112-00613	PE130R39UVC2	PE130R	130 lbs (578.3)	16.25" (413.0)	4.84" (123.0)	.36" (9.0)	Grape	100
112-00614	PE130R40UVC2	PE130R	130 lbs (578.3)	16.25" (413.0)	4.84" (123.0)	.36" (9.0)	Rose Pink	100
112-00615	PE130R41UVC2	PE130R	130 lbs (578.3)	16.25" (413.0)	4.84" (123.0)	.36" (9.0)	Lemon Yellow	100
112-00616	PE130R42UVC2	PE130R	130 lbs (578.3)	16.25" (413.0)	4.84" (123.0)	.36" (9.0)	Sky Blue	100
112-00617	PE130R43UVC2	PE130R	130 lbs (578.3)	16.25" (413.0)	4.84" (123.0)	.36" (9.0)	Charcoal	100
112-00618	PE130R4UVC2	PE130R	130 lbs (578.3)	16.25" (413.0)	4.84" (123.0)	.36" (9.0)	Yellow	100
112-00619	PE130R8AUVC2	PE130R	130 lbs (578.3)	16.25" (413.0)	4.84" (123.0)	.36" (9.0)	Light Grey	100

Installation tools - MK9, MK9HT, MK9P. Dimensions are approximate and subject to technical changes. Use **Part No.** for ordering and **Type** for specification purposes.

Cable Ties

Parallel Entry Ties *continued*

Material Data	
Material	Polyamide 6.6 UV-resistant (PA66UV)
Operating Temperature	-40 °F to +185 °F (-40 °C to +85 °C)
Flammability	UL94 V2

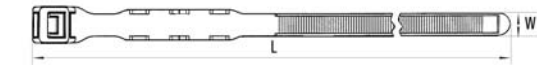

Retainer

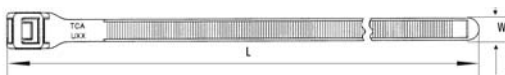

No Retainer

Product Selection

Article No.	Part No.	Type	Min. Tensile Strength		Length (L)		Max. Ø Bundle		Width (W)		Color	Pkg. Qty.
			lbs.	(N)	in.	(mm)	in.	(mm)	in.	(mm)		
PER130R												
112-00800	PER130R0UVC2	PER130R	130 lbs	(578.3)	16.25"	(413.0)	4.84"	(123.0)	.49"	(12.4)	Black	100
112-00802	PER130R14UVC2	PER130R	130 lbs	(578.3)	16.25"	(413.0)	4.84"	(123.0)	.49"	(12.4)	Watermelon	100
112-00803	PER130R20UVC2	PER130R	130 lbs	(578.3)	16.25"	(413.0)	4.84"	(123.0)	.49"	(12.4)	Custom Blue	100
112-00804	PER130R21UVC2	PER130R	130 lbs	(578.3)	16.25"	(413.0)	4.84"	(123.0)	.49"	(12.4)	Custom Green	100
112-00805	PER130R23UVC2	PER130R	130 lbs	(578.3)	16.25"	(413.0)	4.84"	(123.0)	.49"	(12.4)	Raspberry	100
112-00806	PER130R31UVC2	PER130R	130 lbs	(578.3)	16.25"	(413.0)	4.84"	(123.0)	.49"	(12.4)	Aquamarine	100
112-00807	PER130R4UVC2	PER130R	130 lbs	(578.3)	16.25"	(413.0)	4.84"	(123.0)	.49"	(12.4)	Yellow	100
112-00808	PER130R6AUVC2	PER130R	130 lbs	(578.3)	16.25"	(413.0)	4.84"	(123.0)	.49"	(12.4)	Light Blue	100
112-00809	PER130R7UVC2	PER130R	130 lbs	(578.3)	16.25"	(413.0)	4.84"	(123.0)	.49"	(12.4)	Purple	100
112-00810	PER130R8AUVC2	PER130R	130 lbs	(578.3)	16.25"	(413.0)	4.84"	(123.0)	.49"	(12.4)	Light Grey	100
PE130I												
112-00500	PE130I0UVC2	PE130I	130 lbs	(578.3)	21"	(533.0)	6.22"	(158.0)	.35"	(9.0)	Black	100
112-00501	PE130I10UVC2	PE130I	130 lbs	(578.3)	21"	(533.0)	6.22"	(158.0)	.35"	(9.0)	White	100
112-00502	PE130I14UVC2	PE130I	130 lbs	(578.3)	21"	(533.0)	6.22"	(158.0)	.35"	(9.0)	Watermelon	100
112-00503	PE130I17UVC2	PE130I	130 lbs	(578.3)	21"	(533.0)	6.22"	(158.0)	.35"	(9.0)	Tan	100
112-00504	PE130I20UVC2	PE130I	130 lbs	(578.3)	21"	(533.0)	6.22"	(158.0)	.35"	(9.0)	Custom Blue	100
112-00505	PE130I21UVC2	PE130I	130 lbs	(578.3)	21"	(533.0)	6.22"	(158.0)	.35"	(9.0)	Custom Green	100
112-00506	PE130I22UVC2	PE130I	130 lbs	(578.3)	21"	(533.0)	6.22"	(158.0)	.35"	(9.0)	Lavender	100
112-00507	PE130I23UVC2	PE130I	130 lbs	(578.3)	21"	(533.0)	6.22"	(158.0)	.35"	(9.0)	Raspberry	100
112-00508	PE130I31UVC2	PE130I	130 lbs	(578.3)	21"	(533.0)	6.22"	(158.0)	.35"	(9.0)	Aquamarine	100
112-00509	PE130I32UVC2	PE130I	130 lbs	(578.3)	21"	(533.0)	6.22"	(158.0)	.35"	(9.0)	Butterscotch	100
112-00510	PE130I4UVC2	PE130I	130 lbs	(578.3)	21"	(533.0)	6.22"	(158.0)	.35"	(9.0)	Yellow	100
112-00511	PE130I6AUVC2	PE130I	130 lbs	(578.3)	21"	(533.0)	6.22"	(158.0)	.35"	(9.0)	Light Blue	100
112-00512	PE130I8AUVC2	PE130I	130 lbs	(578.3)	21"	(533.0)	6.22"	(158.0)	.35"	(9.0)	Light Grey	100

Installation tools - MK9, MK9HT, MK9P. Dimensions are approximate and subject to technical changes. Use **Part No.** for ordering and **Type** for specification purposes.

Stainless Steel Cable Ties

HellermannTyton's stainless steel ties are designed to secure hoses, cables, poles, pipes, and more when harsh environmental conditions may adversely affect the bundling application. Used where corrosion, vibration, weathering, radiation, and temperature extremes are a concern, HellermannTyton's stainless steel ties can be used in virtually any indoor, outdoor, and underground application.

MK9SST Stainless Steel Cable Tie Installation Tool

Product Selection			Description	Cable Tie Series	Pkg. Qty.
Article No.	Part No.	Type			
110-95000	MK9SST	MK9SST	Adapted for use with stainless steel ties, the MK9 Stainless Steel tool retains the same design features as the MK9 series. The MK9SST accommodates all HellermannTyton stainless steel ties. Comes standard with padded foam grips for comfort and control and a hook for hanging on a belt or tether.	All MBT Series for both 304 and 316 materials	1

304 Material

Grade 304 material is commonly used for stainless steel bundling applications and suits most general purpose requirements. It features the ability to withstand most environmental conditions, particularly in applications where vibration, general weathering, radiation and temperature extremes are a concern.

- Self locking, ball bearing mechanism for quick and easy installation, either by hand or by tensioning tool
- Fully enclosed head does not allow dirt or grit to interfere with locking mechanism
- High tensile strength option for added strength and safety on heavy duty applications



HellermannTyton's MK9SST tool is durable and lightweight offering superior stainless steel cable tie installation.

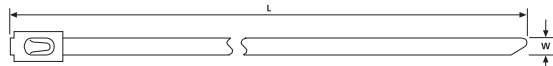

Material Data	
Material	Stainless Steel Type SS304 (SS304)
Operating Temperature	-112 °F to +1000 °F (-80 °C to +538 °C)



Product Selection			Min. Tensile Strength	Length (L)	Max. Ø Bundle	Width (W)	Pkg. Qty.
Article No.	Part No.	Type					
150 lb. Stainless Steel Ties			lbs. (N)	in. (mm)	in. (mm)	in. (mm)	
111-93058	MBT5S-S	MBT5SS	150 lbs (670)	5.0" (127)	1" (25)	.18" (4.6)	100
111-93088	MBT8S-S	MBT8SS	150 lbs (670)	7.9" (201)	2" (50)	.18" (4.6)	100
111-93148	MBT14S-S	MBT14SS	150 lbs (670)	14.3" (362)	4" (102)	.18" (4.6)	100
111-93208	MBT20S-S	MBT20SS	150 lbs (670)	20.5" (521)	6" (152)	.18" (4.6)	100
111-93278	MBT27S-S	MBT27SS	150 lbs (670)	26.8" (681)	8" (203)	.18" (4.6)	100
111-93338	MBT33S-S	MBT33SS	150 lbs (670)	33" (838)	10" (254)	.18" (4.6)	100
250 lb. Stainless Steel Ties							
111-94088	MBT8H-S	MBT8HS	250 lbs (1115)	7.9" (201)	2" (50)	.31" (7.9)	50
111-94148	MBT14H-S	MBT14HS	250 lbs (1115)	14.3" (362)	4" (102)	.31" (7.9)	50
111-94208	MBT20H-S	MBT20HS	250 lbs (1115)	20.5" (521)	6" (152)	.31" (7.9)	50
111-94278	MBT27H-S	MBT27HS	250 lbs (1115)	26.8" (681)	8" (203)	.31" (7.9)	50
111-94338	MBT33H-S	MBT33HS	250 lbs (1115)	33" (838)	10" (254)	.31" (7.9)	50

Installation tools for the above cable ties - MK9SST Dimensions are approximate and subject to technical changes. Use **Part No.** for ordering and **Type** for specification purposes. Stainless steel ties and materials should be tested thoroughly under end use conditions to determine suitability for the application.

Stainless Steel Cable Ties *continued*

316 Material

Grade 316 material is highly resistant to corrosion and widely used in marine environments where chemicals, salts, acids, and temperature extremes may affect the bundling application. MBT stainless steel ties in 316 steel material are also available with a nylon 11 protective coating. This coating creates a barrier and protectant from chemical reactions of dissimilar metals.



- Self locking, ball bearing mechanism for quick and easy installation, either by hand or by tensioning tool
- Fully enclosed head does not allow dirt or grit to interfere with locking mechanism
- High tensile strength option available for added strength and safety on heavy duty applications

Material Data	
Material	Stainless Steel Type SS316 (SS316)
Operating Temperature	-112 °F to +1000 °F (-80 °C to +538 °C)

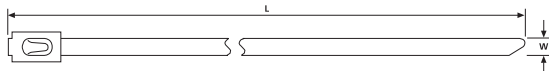

Product Selection			Min. Tensile Strength	Length (L)	Max. Ø Bundle	Width (W)	Pkg. Qty.
Article No.	Part No.	Type	lbs. (N)	in. (mm)	in. (mm)	in. (mm)	
150 lb. Stainless Steel Ties							
111-93959	MBT5S	MBT5S	150 lbs (670)	5.0" (127)	1.0" (25.4)	.18" (4.6)	100
111-93089	MBT8S	MBT8S	150 lbs (670)	7.9" (201)	2.0" (50)	.18" (4.6)	100
111-93149	MBT14S	MBT14S	150 lbs (670)	14.3" (362)	4.0" (102)	.18" (4.6)	100
111-93209	MBT20S	MBT20S	150 lbs (670)	20.5" (521)	6.0" (152)	.18" (4.6)	100
111-93279	MBT27S	MBT27S	150 lbs (670)	26.8" (681)	8.0" (203)	.18" (4.6)	100
111-93339	MBT33S	MBT33S	150 lbs (670)	33.0" (838)	10.0" (254)	.18" (4.6)	100
250 lb. Stainless Steel Ties							
111-94089	MBT8H	MBT8H	250 lbs (1115)	7.9" (201)	2.0" (50.8)	.31" (7.9)	50
111-94149	MBT14H	MBT14H	250 lbs (1115)	14.3" (362)	4.0" (102)	.31" (7.9)	50
111-94209	MBT20H	MBT20H	250 lbs (1115)	20.5" (521)	6.0" (152)	.31" (7.9)	50
111-94279	MBT27H	MBT27H	250 lbs (1115)	26.8" (681)	8.0" (203)	.31" (7.9)	50
111-94339	MBT33H	MBT33H	250 lbs (1115)	33.0" (838)	10.0" (254)	.31" (7.9)	50

Installation tools for the above cable ties - MK9SST Dimensions are approximate and subject to technical changes. Use **Part No.** for ordering and **Type** for specification purposes. Stainless steel ties and materials should be tested thoroughly under end use conditions to determine suitability for the application.

Grip Tie Straps

The Grip Tie is a low profile, one piece fastening device. Constructed of polyethylene hook and nylon loop and laminated back to back, the Grip Tie features quick release for repetitive access to cable and wire. It can be opened and closed numerous times without failure. The Grip Tie is reusable, adjustable, releasable, and easy to install.

Available in rolls and straps in 6", 8", 11" and 15" sizes. Grip Ties are available in a variety of colors and are versatile enough for applications ranging from network installations to bundling power cords. Grip Ties are also customizable with your company name (minimum quantities apply).

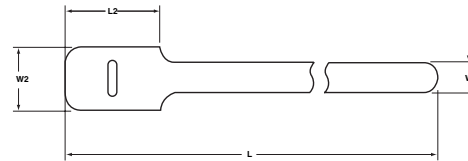

Product Selection

Article No.	Part No.	Type	Min. Tensile Strength		Length (L)	Max. Ø Bundle	Width (W)	Width (W2)	Length (L2)	Color	Pkg. Qty.
			lbs.	(N)	in.	(mm)	in.	(mm)	in.		
6" Grip Ties											
854-44316	GT.375X60C2	GT.375X6	40 lbs	(177.93)	6" (152.4)	1" (25.4)	.375" (9.525)	.75" (19.05)	1.5" (38.1)	Black	100
854-44339	GT.50X60P2	GT.50X6	40 lbs	(177.93)	6" (152.4)	1" (25.4)	.5" (12.7)	1" (25.4)	1.5" (38.1)		10
854-44336	GT.50X60C2	GT.50X6	40 lbs	(177.93)	6" (152.4)	1" (25.4)	.5" (12.7)	1" (25.4)	1.5" (38.1)	Red	100
854-44342	GT.50X62P2	GT.50X6	40 lbs	(177.93)	6" (152.4)	1" (25.4)	.5" (12.7)	1" (25.4)	1.5" (38.1)		10
854-44341	GT.50X62C2	GT.50X6	40 lbs	(177.93)	6" (152.4)	1" (25.4)	.5" (12.7)	1" (25.4)	1.5" (38.1)	Orange	100
854-44344	GT.50X63P2	GT.50X6	40 lbs	(177.93)	6" (152.4)	1" (25.4)	.5" (12.7)	1" (25.4)	1.5" (38.1)		10
854-44343	GT.50X63C2	GT.50X6	40 lbs	(177.93)	6" (152.4)	1" (25.4)	.5" (12.7)	1" (25.4)	1.5" (38.1)	Yellow	100
854-44346	GT.50X64P2	GT.50X6	40 lbs	(177.93)	6" (152.4)	1" (25.4)	.5" (12.7)	1" (25.4)	1.5" (38.1)		10
854-44345	GT.50X64C2	GT.50x6	40 lbs	(177.93)	6" (152.4)	1" (25.4)	.5" (12.7)	1" (25.4)	1.5" (38.1)	Green	100
854-44348	GT.50X65P2	GT.50x6	40 lbs	(177.93)	6" (152.4)	1" (25.4)	.5" (12.7)	1" (25.4)	1.5" (38.1)		10
854-44347	GT.50X65C2	GT.50X6	40 lbs	(177.93)	6" (152.4)	1" (25.4)	.5" (12.7)	1" (25.4)	1.5" (38.1)	Blue	100
854-44350	GT.50X66P2	GT.50X6	40 lbs	(177.93)	6" (152.4)	1" (25.4)	.5" (12.7)	1" (25.4)	1.5" (38.1)		10
854-44349	GT.50X66C2	GT.50X6	40 lbs	(177.93)	6" (152.4)	1" (25.4)	.5" (12.7)	1" (25.4)	1.5" (38.1)	100	
8" Grip Ties											
854-44355	GT.50X80P2	GT.50x8	40 lbs	(177.93)	8" (203.2)	1.75" (44.45)	.5" (12.7)	1" (25.4)	1.5" (38.1)	Black	10
854-44353	GT.50X80C2	GT.50x8	40 lbs	(177.93)	8" (203.2)	1.75" (44.45)	.5" (12.7)	1" (25.4)	1.5" (38.1)		100
854-44358	GT.50X82P2	GT.50X8	40 lbs	(177.93)	8" (203.2)	1.75" (44.45)	.5" (12.7)	1" (25.4)	1.5" (38.1)	Red	10
854-44357	GT.50X82C2	GT.50X8	40 lbs	(177.93)	8" (203.2)	1.75" (44.45)	.5" (12.7)	1" (25.4)	1.5" (38.1)		100
854-44360	GT.50X83P2	GT.50X8	40 lbs	(177.93)	8" (203.2)	1.75" (44.45)	.5" (12.7)	1" (25.4)	1.5" (38.1)	Orange	10
854-44359	GT.50X83C2	GT.50X8	40 lbs	(177.93)	8" (203.2)	1.75" (44.45)	.5" (12.7)	1" (25.4)	1.5" (38.1)		100
854-44362	GT.50X84P2	GT.50X8	40 lbs	(177.93)	8" (203.2)	1.75" (44.45)	.5" (12.7)	1" (25.4)	1.5" (38.1)	Yellow	10
854-44361	GT.50X84C2	GT.50X8	40 lbs	(177.93)	8" (203.2)	1.75" (44.45)	.5" (12.7)	1" (25.4)	1.5" (38.1)		100
854-44364	GT.50X85P2	GT.50X8	40 lbs	(177.93)	8" (203.2)	1.75" (44.45)	.5" (12.7)	1" (25.4)	1.5" (38.1)	Green	10
854-44363	GT.50X85C2	GT.50X8	40 lbs	(177.93)	8" (203.2)	1.75" (44.45)	.5" (12.7)	1" (25.4)	1.5" (38.1)		100
854-44366	GT.50X86P2	GT.50X8	40 lbs	(177.93)	8" (203.2)	1.75" (44.45)	.5" (12.7)	1" (25.4)	1.5" (38.1)	Blue	10
854-44365	GT.50X86C2	GT.50X8	40 lbs	(177.93)	8" (203.2)	1.75" (44.45)	.5" (12.7)	1" (25.4)	1.5" (38.1)		100

Dimensions are approximate and subject to technical changes. Use **Part No.** for ordering and **Type** for specification purposes.

Grip Ties

Grip Tie Straps *continued*

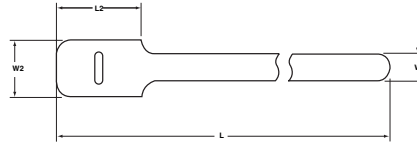

Product Selection			Min. Tensile Strength	Length (L)	Max. Ø Bundle	Width (W)	Width (W2)	Length (L2)	Color	Pkg. Qty.
Article No.	Part No.	Type								
11" Grip Ties										
854-44320	GT.50X110P2	GT.50X11	40 lbs (177.93)	11" (279.4)	2.63" (66.802)	.5" (12.7)	1" (25.4)	1.5" (38.1)	Black	10
854-44317	GT.50X110C2	GT.50X11	40 lbs (177.93)	11" (279.4)	2.63" (66.802)	.5" (12.7)	1" (25.4)	1.5" (38.1)		100
854-44323	GT.50X112P2	GT.50X11	40 lbs (177.93)	11" (279.4)	2.63" (66.802)	.5" (12.7)	1" (25.4)	1.5" (38.1)	Red	10
854-44322	GT.50X112C2	GT.50X11	40 lbs (177.93)	11" (279.4)	2.63" (66.802)	.5" (12.7)	1" (25.4)	1.5" (38.1)		100
854-44325	GT.50X113P2	GT.50X11	40 lbs (177.93)	11" (279.4)	2.63" (66.802)	.5" (12.7)	1" (25.4)	1.5" (38.1)	Orange	10
854-44324	GT.50X113C2	GT.50X11	40 lbs (177.93)	11" (279.4)	2.63" (66.802)	.5" (12.7)	1" (25.4)	1.5" (38.1)		100
854-44327	GT.50X114P2	GT.50X11	40 lbs (177.93)	11" (279.4)	2.63" (66.802)	.5" (12.7)	1" (25.4)	1.5" (38.1)	Yellow	10
854-44326	GT.50X114C2	GT.50X11	40 lbs (177.93)	11" (279.4)	2.63" (66.802)	.5" (12.7)	1" (25.4)	1.5" (38.1)		100
854-44329	GT.50X115P2	GT.50X11	40 lbs (177.93)	11" (279.4)	2.63" (66.802)	.5" (12.7)	1" (25.4)	1.5" (38.1)	Green	10
854-44328	GT.50X115C2	GT.50X11	40 lbs (177.93)	11" (279.4)	2.63" (66.802)	.5" (12.7)	1" (25.4)	1.5" (38.1)		100
854-44331	GT.50X116P2	GT.50X11	40 lbs (177.93)	11" (279.4)	2.63" (66.802)	.5" (12.7)	1" (25.4)	1.5" (38.1)	Blue	10
854-44330	GT.50X116C2	GT.50X11	40 lbs (177.93)	11" (279.4)	2.63" (66.802)	.5" (12.7)	1" (25.4)	1.5" (38.1)		100
15" Grip Ties										
854-44371	GT.75X150P2	GT.75X15	50 lbs (222.41)	15" (381)	3.88" (98.552)	.75" (19.05)	1.5" (38.1)	2.5" (63.5)	Black	10
854-44369	GT.75X150C2	GT.75X15	50 lbs (222.41)	15" (381)	3.88" (98.552)	.75" (19.05)	1.5" (38.1)	2.5" (63.5)		100
854-44374	GT.75X152P2	GT.75X15	50 lbs (222.41)	15" (381)	3.88" (98.552)	.75" (19.05)	1.5" (38.1)	2.5" (63.5)	Red	10
854-44373	GT.75X152C2	GT.75X15	50 lbs (222.41)	15" (381)	3.88" (98.552)	.75" (19.05)	1.5" (38.1)	2.5" (63.5)		100
854-44376	GT.75X153P2	GT.75X15	50 lbs (222.41)	15" (381)	3.88" (98.552)	.75" (19.05)	1.5" (38.1)	2.5" (63.5)	Orange	10
854-44375	GT.75X153C2	GT.75X15	50 lbs (222.41)	15" (381)	3.88" (98.552)	.75" (19.05)	1.5" (38.1)	2.5" (63.5)		100
854-44377	GT.75X154C2	GT.75X15	50 lbs (222.41)	15" (381)	3.88" (98.552)	.75" (19.05)	1.5" (38.1)	2.5" (63.5)	Yellow	100
854-44378	GT.75X154P2	GT.75X15	50 lbs (222.41)	15" (381)	3.88" (98.552)	.75" (19.05)	1.5" (38.1)	2.5" (63.5)		10
854-44380	GT.75X155P2	GT.75X15	50 lbs (222.41)	15" (381)	3.88" (98.552)	.75" (19.05)	1.5" (38.1)	2.5" (63.5)	Green	10
854-44379	GT.75X155C2	GT.75X15	50 lbs (222.41)	15" (381)	3.88" (98.552)	.75" (19.05)	1.5" (38.1)	2.5" (63.5)		100
854-44382	GT.75X156P2	GT.75X15	50 lbs (222.41)	15" (381)	3.88" (98.552)	.75" (19.05)	1.5" (38.1)	2.5" (63.5)	Blue	10
854-44381	GT.75X156C2	GT.75X15	50 lbs (222.41)	15" (381)	3.88" (98.552)	.75" (19.05)	1.5" (38.1)	2.5" (63.5)		100

Dimensions are approximate and subject to technical changes. Use **Part No.** for ordering and **Type** for specification purposes.

Grip Tie Rolls

For custom-cut lengths, HellermannTyton offers the hook and loop strap on a five yard and 25 yard roll. Ideal for job site applications, desired lengths can be cut on the spot.



Product Selection						
Article No.	Part No.	Type	Width (W)		Color	Pkg. Qty.
			in.	(mm)		
854-44384	GT.75X1800	GT.75X180	.75"	(19.05)	Black	180" (5 yds.)
854-44388	GT.75X1802	GT.75X180	.75"	(19.05)	Red	180" (5 yds.)
854-44389	GT.75X1803	GT.75X180	.75"	(19.05)	Orange	180" (5 yds.)
854-44390	GT.75X1804	GT.75X180	.75"	(19.05)	Yellow	180" (5 yds.)
854-44391	GT.75X1805	GT.75X180	.75"	(19.05)	Green	180" (5 yds.)
854-44392	GT.75X1806	GT.75X180	.75"	(19.05)	Blue	180" (5 yds.)
854-44395	GT.75X6000	GT.75X600	.75"	(19.05)	Black	600" (16.6 yds.)
854-44396	GT.75X9000	GT.75X900	.75"	(19.05)	Black	900" (25 yds.)
854-44397	GT.75X9004	GT.75X900	.75"	(19.05)	Yellow	900" (25 yds.)

Dimensions are approximate and subject to technical changes. Use **Part No.** for ordering and **Type** for specification purposes.

Write-on Grip Ties

In situations where instant identification is needed, HellermannTyton provides Grip Ties with a white write-on area. This smudge-free surface is ideal for fast and easy identification with a ballpoint pen or felt-tip marker. The write-on area is approximately 3/8”(H) x 1-1/4”(W). It is positioned in the center of the black 6”, 8” and 11” straps, as well as spaced every 12” on the Grip Tie rolls.

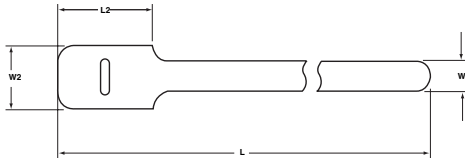

Product Selection			Min. Tensile Strength	Length (L)	Max. Ø Bundle	Width (W)	Width (W2)	Length (L2)	Color	Pkg. Qty.
Article No.	Part No.	Type								
854-44340	GT.50X60P2W	GT.50X6W	40 lbs (177.93)	6" (152.4)	1" (25.4)	.5" (12.7)	1" (25.4)	1.5" (38.1)	Black	10
854-44338	GT.50X60C2W	GT.50X6W	40 lbs (177.93)	6" (152.4)	1" (25.4)	.5" (12.7)	1" (25.4)	1.5" (38.1)	Black	100
854-44356	GT.50X80P2W	GT.50X8W	40 lbs (177.93)	8" (203.2)	1.75" (44.45)	.5" (12.7)	1" (25.4)	1.5" (38.1)	Black	10
854-44354	GT.50X80C2W	GT.50X8W	40 lbs (177.93)	8" (203.2)	1.75" (44.45)	.5" (12.7)	1" (25.4)	1.5" (38.1)	Black	100
854-44321	GT.50X110P2W	GT.50X11W	40 lbs (177.93)	11" (279.4)	2.63" (66.8)	.5" (12.7)	1" (25.4)	1.5" (38.1)	Black	10
854-44319	GT.50X110C2W	GT.50X11W	40 lbs (177.93)	11" (279.4)	2.63" (66.8)	.5" (12.7)	1" (25.4)	1.5" (38.1)	Black	10
854-44386	GT.75X1800W	GT.75X180W	-	180" (5 Yds.)	-	.75" (19.05)	-	-	Black	180"

Dimensions are approximate and subject to technical changes. Use **Part No.** for ordering and **Type** for specification purposes.

Grip Ties for Plenum Applications

HellermannTyton offers UL94V-2 flame rated Grip Ties for use in air handling spaces. These Grip Ties are UL Listed in accordance with the National Electrical Code regulations. They are available in three lengths as well as a 180” roll.

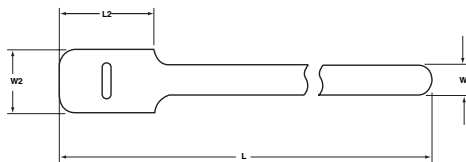

Product Selection			Min. Tensile Strength	Length (L)	Max. Ø Bundle	Width (W)	Width (W2)	Length (L2)	Color	Pkg. Qty.
Article No.	Part No.	Type								
854-44352	GT.50X6MP2V2	GT.50X6	40 lbs (177.93)	6" (152.4)	1" (25.4)	.5" (12.7)	1" (25.4)	1.5" (38.1)	Maroon	10
854-44368	GT.50X8MP2V2	GT.50X8	40 lbs (177.93)	8" (203.2)	1.91" (48.5)	.5" (12.7)	1" (25.4)	1.5" (38.1)	Maroon	10
854-44334	GT.50X12MP2V2	GT.50X12	40 lbs (177.93)	12" (304.8)	3.18" (80.7)	.5" (12.7)	1" (25.4)	1.5" (38.1)	Maroon	10
854-44394	GT.75X180MV2	GT.75X180	-	-	-	.75" (19.05)	-	-	Maroon	180"

Dimensions are approximate and subject to technical changes. Use **Part No.** for ordering and **Type** for specification purposes.

Cable Tie Mounts

Cable Tie Mounts

HellermannTyton offers a wide variety of mounting bases suited for many applications. Mounting bases are used in conjunction with cable ties to stabilize and secure wiring bundles, both indoors and outdoors. These mounting bases can be secured to a surface using rubber based adhesive, acrylic adhesive, or also can be screw mounted.

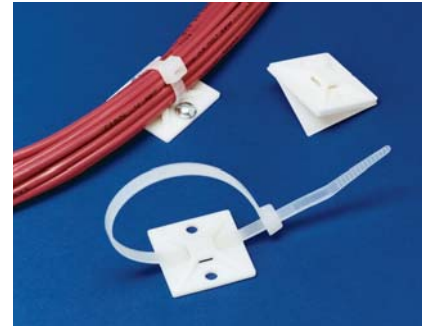

Adhesive mounts are supplied in pairs connected together on an adhesive liner.

Cable Tie Mounting Bases

HellermannTyton's 4-way mounting bases are available in four sizes to accommodate T18 through T150 series cable ties. Insertion of ties can be made from all four sides. Each mount may be secured with two screws (four screws for the MB2.5 mount), with adhesive backing, or both, for ease of application and stability.

For applications where higher temperatures, certain chemicals, or UV radiation are a concern and an adhesive is the preferred method for securing, the acrylic adhesive 4-way mounting bases are recommended. The 2-way mounting bases may be secured with one screw, with adhesive backing, or both, and allow ties to be inserted from two sides.

Material Data	
Material	Polyamide 6.6 (PA66)
Operating Temperature	-40 °F to +185 °F (-40 °C to +85 °C) continuous
Flammability	UL94 V2 (excluding adhesive)

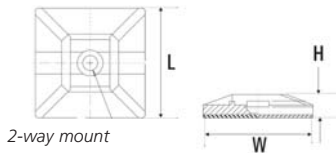

2-way mount

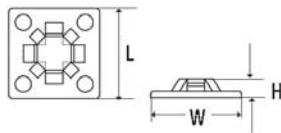

4-way, MB2.5 mount

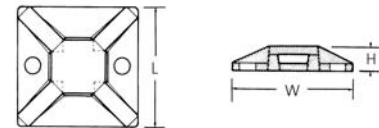

4-way, MB3, MB4 and MB5 mounts

Cable Tie Mounting Bases - Screw Mount

US
File# E64139

Product Selection					Length (L)	Width (W)	Height (H)	Color	Pkg. Qty.
Article No.	Part No.	Type	Cable Tie Series	Mounting					
2- Way Screw Mount									
151-29104	MB4SH10C2	MB4SH	T18 - T50	# 6 Screw	1.115" (28.32)	1.115" (28.32)	.202" (5.13)	White	100
151-00323	MB4SH10H4	MB4SH			1.115" (28.32)	1.115" (28.32)	.202" (5.13)	White	500
151-29100	MB4SH0C2	MB4SH			1.115" (28.32)	1.115" (28.32)	.202" (5.13)	Black	100
151-29101	MB4SH0H4	MB4SH			1.115" (28.32)	1.115" (28.32)	.202" (5.13)	Black	500
4- Way Screw Mount									
151-28901	MB2.510C2	MB2.5	T18	# 3 Screw	.625" (15.88)	.625" (15.88)	.130" (3.3)	White	100
151-28902	MB2.510M4	MB2.5			.625" (15.88)	.625" (15.88)	.130" (3.3)	White	1000
151-00285	MB2.50C2	MB2.5			.625" (15.88)	.625" (15.88)	.130" (3.3)	Black	100
151-00286	MB2.50M4	MB2.5			.625" (15.88)	.625" (15.88)	.130" (3.3)	Black	1000
151-28302	MB310C2	MB3	T18, T30	#4 Screw	.75" (19.0)	.75" (19.0)	.15" (3.8)	White	100
151-28305	MB310M4	MB3			.75" (19.0)	.75" (19.0)	.15" (3.8)	White	1000
151-00136	MB30C2	MB3			.75" (19.0)	.75" (19.0)	.15" (3.8)	Black	100
151-28301	MB30M4	MB3			.75" (19.0)	.75" (19.0)	.15" (3.8)	Black	1000
151-28802	MB410C2	MB4	T18 - T50	#8 Screw	1.12" (28.5)	1.12" (28.5)	.19" (4.8)	White	100
151-00319	MB410H4	MB4			1.12" (28.5)	1.12" (28.5)	.19" (4.8)	White	500
151-00320	MB40C2	MB4			1.12" (28.5)	1.12" (28.5)	.19" (4.8)	Black	100
151-28801	MB40H4	MB4			1.12" (28.5)	1.12" (28.5)	.19" (4.8)	Black	500
151-00324	MB510C2	MB5	T18 - T150	#8 Screw	1.485" (37.7)	1.485" (37.7)	.245" (6.2)	White	100
151-28504	MB510F4	MB5			1.485" (37.7)	1.485" (37.7)	.245" (6.2)	White	250
151-28500	MB50C2	MB5			1.485" (37.7)	1.485" (37.7)	.245" (6.2)	Black	100
151-28501	MB50F4	MB5			1.485" (37.7)	1.485" (37.7)	.245" (6.2)	Black	250

Dimensions are approximate and subject to technical changes. Use **Part No.** for ordering and **Type** for specification purposes.

Cable Tie Mounting Bases *continued*

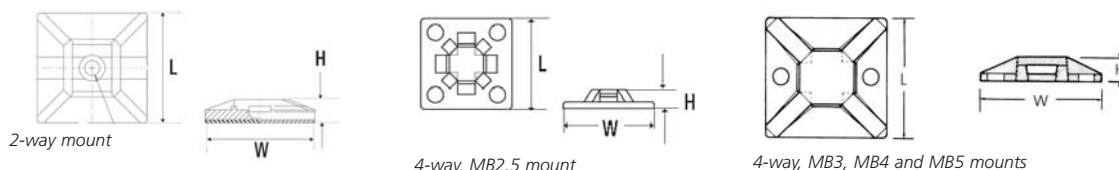

Cable Tie Mounting Bases - Rubber-Based Adhesive

CA US
File# E64139

Product Selection									
Article No.	Part No.	Type	Cable Tie Series	Mounting	Length (L)	Width (W)	Height (H)	Color	Pkg. Qty.
					in. (mm)	in. (mm)	in. (mm)		
2- Way Mount with Rubber - Based Adhesive									
151-29203	MB4SHA10C2	MB4SHA	T18 - T50	Adhesive	1.115" (28.32)	1.115" (28.32)	.232" (5.89)	White	100
151-29206	MB4SHA10H4	MB4SHA			1.115" (28.32)	1.115" (28.32)	.232" (5.89)	White	500
151-29200	MB4SHA0C2	MB4SHA			1.115" (28.32)	1.115" (28.32)	.232" (5.89)	Black	100
4- Way Mount with Rubber - Based Adhesive									
151-29002	MB2.5A10C2	MB2.5A	T18	Adhesive	.625" (15.88)	.625" (15.88)	.160" (4.1)	White	100
151-00298	MB2.5A10M4	MB2.5A			.625" (15.88)	.625" (15.88)	.160" (4.1)	White	1000
151-29000	MB2.5A0C2	MB2.5A			.625" (15.88)	.625" (15.88)	.160" (4.1)	Black	100
151-29001	MB2.5A0M4	MB2.5A			.625" (15.88)	.625" (15.88)	.160" (4.1)	Black	1000
151-28718	MB3A10C2	MB3A	T18, T30	Adhesive	.75" (19.0)	.75" (19.0)	.18" (4.6)	White	100
151-28721	MB3A10M4	MB3A			.75" (19.0)	.75" (19.0)	.18" (4.6)	White	1000
151-28710	MB3A0C2	MB3A			.75" (19.0)	.75" (19.0)	.18" (4.6)	Black	100
151-28713	MB3A0M4	MB3A			.75" (19.0)	.75" (19.0)	.18" (4.6)	Black	1000
151-28421	MB4A10C2	MB4A	T18 - T50	Adhesive	1.12" (28.0)	1.12" (28.0)	.22" (5.6)	White	100
151-00321	MB4A10H4	MB4A			1.12" (28.0)	1.12" (28.0)	.22" (5.6)	White	500
151-28403	MB4A0C2	MB4A			1.12" (28.0)	1.12" (28.0)	.22" (5.6)	Black	100
151-28406	MB4A0H4	MB4A			1.12" (28.0)	1.12" (28.0)	.22" (5.6)	Black	500
151-28529	MB5A10C2	MB5A	T18 - T150	Adhesive	1.485" (37.7)	1.485" (37.7)	.275" (6.9)	White	100
151-00427	MB5A10F4	MB5A			1.485" (37.7)	1.485" (37.7)	.275" (6.9)	White	250
151-28602	MB5A0C2	MB5A			1.485" (37.7)	1.485" (37.7)	.275" (6.9)	Black	100
151-28605	MB5A0F4	MB5A			1.485" (37.7)	1.485" (37.7)	.275" (6.9)	Black	250

Dimensions are approximate and subject to technical changes. Use **Part No.** for ordering and **Type** for specification purposes.

Cable Tie Mounting Bases - Acrylic Adhesive

Product Selection									
Article No.	Part No.	Type	Cable Tie Series	Mounting	Length (L)	Width (W)	Height (H)	Color	Pkg. Qty.
					in. (mm)	in. (mm)	in. (mm)		
4 - Way Screw Mount Acrylic Adhesive									
151-00331	MB3A10A2C2	MB3A	T18, T30	Adhesive	.75" (19.0)	.75" (19.0)	.18" (4.6)	White	100
151-28717	MB3A10A2H4	MB3A			.75" (19.0)	.75" (19.0)	.18" (4.6)	White	500
151-28711	MB3A0A2C2	MB3A			.75" (19.0)	.75" (19.0)	.18" (4.6)	Black	100
151-28709	MB3A0A2H4	MB3A			.75" (19.0)	.75" (19.0)	.18" (4.6)	Black	500
151-28420	MB4A10A2C2	MB4A	T18 - T50	Adhesive	1.12" (28.5)	1.12" (28.5)	.23" (5.9)	White	100
151-00322	MB4A10A2H4	MB4A			1.12" (28.5)	1.12" (28.5)	.23" (5.9)	White	500
151-28402	MB4A0A2C2	MB4A			1.12" (28.5)	1.12" (28.5)	.23" (5.9)	Black	100
151-28405	MB4A0A2H4	MB4A			1.12" (28.5)	1.12" (28.5)	.23" (5.9)	Black	500
151-28607	MB5A10A2C2	MB5A	T18 - T150	Adhesive	1.485" (37.7)	1.485" (37.7)	.275" (6.9)	White	100
151-28610	MB5A10A2F4	MB5A			1.485" (37.7)	1.485" (37.7)	.275" (6.9)	White	250
151-28600	MB5A0A2C2	MB5A			1.485" (37.7)	1.485" (37.7)	.275" (6.9)	Black	100
151-28604	MB5A10A2F4	MB5A			1.485" (37.7)	1.485" (37.7)	.275" (6.9)	Black	250

Dimensions are approximate and subject to technical changes. Use **Part No.** for ordering and **Type** for specification purposes.

Cable Tie Mounts

Cable Tie Mounts

The CTM series is designed to provide stability to wire bundles. These mounts can accommodate miniature, intermediate, or standard cross-section cable ties. Each mount is secured with a single screw.



Material Data	
Material	Polyamide 6.6 (PA66)
Operating Temperature	-40 °F to +185 °F (-40 °C to +85 °C) continuous
Flammability	UL94 V2

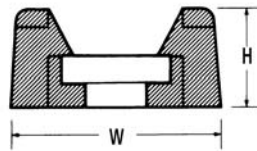
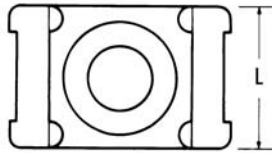

UL
File# E64139

Product Selection													
Article No.	Part No.	Type	Cable Tie Series	Mounting	Length (L)		Width (W)		Height (H)				
					in.	(mm)	in.	(mm)	in.	(mm)	Color	Pkg. Qty.	
151-30303	CTM010C2	CTM0	T18 - T50	# 6 Screw	.578"	(14.68)	.375"	(9.52)	.266"	(6.76)	White	100	
151-30305	CTM010M4				.578"	(14.68)	.375"	(9.52)	.266"	(6.76)	White	1000	
151-30300	CTM00C2				.578"	(14.68)	.375"	(9.52)	.266"	(6.76)	Black	100	
151-30301	CTM00M4				.578"	(14.68)	.375"	(9.52)	.266"	(6.76)	Black	1000	
151-30404	CTM110C2	CTM1		T18 - T120	# 8 Screw	.579"	(14.71)	.370"	(9.40)	.266"	(6.76)	White	100
151-30406	CTM110M4					.579"	(14.71)	.370"	(9.40)	.266"	(6.76)	White	1000
151-30400	CTM10C2					.579"	(14.71)	.370"	(9.40)	.266"	(6.76)	Black	100
151-30402	CTM10M4					.579"	(14.71)	.370"	(9.40)	.266"	(6.76)	Black	1000
151-30504	CTM210C2	CTM2	T18 - T120		# 8 Screw	.857"	(21.77)	.605"	(15.37)	.372"	(9.45)	White	100
151-30506	CTM210M4					.857"	(21.77)	.605"	(15.37)	.372"	(9.45)	White	1000
151-30500	CTM20C2					.857"	(21.77)	.605"	(15.37)	.372"	(9.45)	Black	100
151-30501	CTM20M4					.857"	(21.77)	.605"	(15.37)	.372"	(9.45)	Black	1000
151-30605	CTM310C2	CTM3		T18 - T120	#10 Screw	.858"	(21.79)	.609"	(15.47)	.374"	(9.50)	White	100
151-30607	CTM310M4					.858"	(21.79)	.609"	(15.47)	.374"	(9.50)	White	1000
151-30600	CTM30C2					.858"	(21.79)	.609"	(15.47)	.374"	(9.50)	Black	100
151-30603	CTM30M4					.858"	(21.79)	.609"	(15.47)	.374"	(9.50)	Black	1000
151-30703	CTM410C2	CTM4	T18 - T120		.25" Screw	.864"	(21.95)	.616"	(15.65)	.372"	(9.45)	White	100
151-30705	CTM410M4					.864"	(21.95)	.616"	(15.65)	.372"	(9.45)	White	1000
151-30700	CTM40C2					.864"	(21.95)	.616"	(15.65)	.372"	(9.45)	Black	100
151-30702	CTM40M4					.864"	(21.95)	.616"	(15.65)	.372"	(9.45)	Black	1000

Dimensions are approximate and subject to technical changes. Use **Part No.** for ordering and **Type** for specification purposes.

Low Profile Cable Tie Mounts

Low profile mounts are intended for use in securing bundles where space is limited. Each mount is fastened with a single screw.



Material Data	
Material	Polyamide 6.6 (PA66)
Operating Temperature	-40 °F to +185 °F (-40 °C to +85 °C) continuous
Flammability	UL94 V2

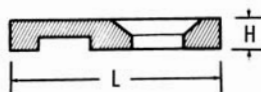

US
File# E64139

Product Selection									
Article No.	Part No.	Type	Cable Tie Series	Mounting	Length (L)	Width (W)	Height (H)	Color	Pkg. Qty.
					in. (mm)	in. (mm)	in. (mm)		
151-00226	MB19C2	MB1	T18	#2 Screw	.500" (12.70)	.312" (7.92)	.130" (3.30)	Natural	100
151-00294	MB19M4				.500" (12.70)	.312" (7.92)	.130" (3.30)	Natural	1000
151-00295	MB10C2				.500" (12.70)	.312" (7.92)	.130" (3.30)	Black	100
151-00296	MB10M4				.500" (12.70)	.312" (7.92)	.130" (3.30)	Black	1000
151-00227	MB29C2	MB2	T18 - T50	# 8 Screw	.807" (20.50)	.490" (12.45)	.130" (3.30)	Natural	100
151-00297	MB29M4				.807" (20.50)	.490" (12.45)	.130" (3.30)	Natural	1000
151-28210	MB20C2				.807" (20.50)	.490" (12.45)	.130" (3.30)	Black	100
151-28202	MB20M4				.807" (20.50)	.490" (12.45)	.130" (3.30)	Black	1000

Dimensions are approximate and subject to technical changes. Use **Part No.** for ordering and **Type** for specification purposes.

Low Profile Rivet Mounts

The low profile rivet mount is designed to secure wiring bundles and fastens with the drive rivet through a predrilled hole. This mount is ideal for use in applications where space is limited.



Material Data	
Material	Polyamide 6.6 (PA66)
Operating Temperature	-40 °F to +185 °F (-40 °C to +85 °C) continuous
Flammability	UL94 V2

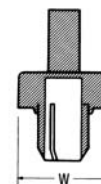
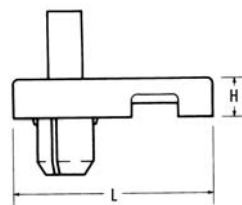

Product Selection										
Article No.	Part No.	Type	Cable Tie Series	Mounting Hole Ø	Max. Panel Thickness	Length (L)	Width (W)	Height (H)	Color	Pkg. Qty.
				in. (mm)	in. (mm)	in. (mm)	in. (mm)	in. (mm)		
151-27000	LKCRF19C2	LKCRF1	T18 -	.250" (6.35)	.134" (3.4)	.938" (23.82)	.470" (11.94)	.157" (3.99)	Natural	100
151-27009	LKCRF19H4	LKCRF1	T50	.250" (6.35)	.134" (3.4)	.938" (23.82)	.470" (11.91)	.157" (3.99)	Natural	500

Dimensions are approximate and subject to technical changes. Use **Part No.** for ordering and **Type** for specification purposes.

Cable Tie Mounts

Push Mounts

Intended for use in a predrilled hole, this push mount accepts T18 through T50 series cable ties. Once inserted through the hole, the mount locks into place.

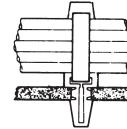
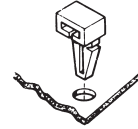
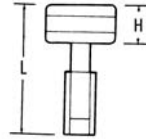
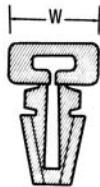
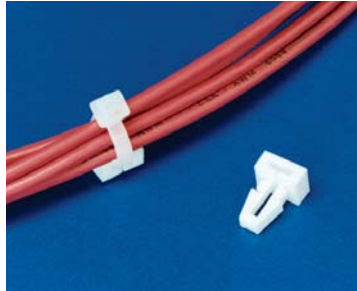

Material Data	
Material	Polyamide 6.6 (PA66)
Operating Temperature	-40 °F to +185 °F (-40 °C to +85 °C) continuous
Flammability	UL94 V2



US
File# E64139

Product Selection

Article No.	Part No.	Type	Cable Tie Series	Mounting Hole Ø	Max. Panel Thickness	Length (L)	Width (W)	Height (H)	Color	Pkg. Qty.
				in. (mm)	in. (mm)	in. (mm)	in. (mm)	in. (mm)		
151-40106	TM1SF10C2	TM1SF	T18 - T50	.25" (6.3)	.134" (3.4)	.616" (15.65)	.401" (10.19)	.181" (4.60)	White	100
151-00328	TM1SF10M4	TM1SF		.25" (6.3)	.134" (3.4)	.616" (15.65)	.401" (10.19)	.181" (4.60)	White	1000
151-40100	TM1SF0C2	TM1SF		.25" (6.3)	.134" (3.4)	.616" (15.65)	.401" (10.19)	.181" (4.60)	Black	100
151-40101	TM1SF0M4	TM1SF		.25" (6.3)	.134" (3.4)	.616" (15.65)	.401" (10.19)	.181" (4.60)	Black	1000

Dimensions are approximate and subject to technical changes. Use **Part No.** for ordering and **Type** for specification purposes.

Push Button Mounts

The push button mounts are used where the back of the panel is accessible.

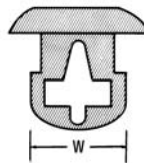
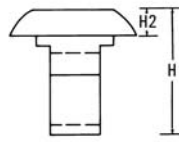

Material Data	
Material	Polyamide 6.6 (PA66)
Operating Temperature	-40 °F to +185 °F (-40 °C to +85 °C) continuous
Flammability	UL94 V2



US
File# E64139

Product Selection

Article No.	Part No.	Type	Cable Tie Series	Mounting Hole Ø	Max. Panel Thickness	Width (W)	Height (H)	Height (H2)	Color	Pkg. Qty.
				in. (mm)	in. (mm)	in. (mm)	in. (mm)	in. (mm)		
151-00230	PBM10C2	PBM	T18 - T50	.25" (6.4)	.122" (3.1)	.26" (6.60)	.40" (10.16)	.08" (2.03)	White	100
151-00231	PBM10M4	PBM		.25" (6.4)	.122" (3.1)	.26" (6.60)	.40" (10.16)	.08" (2.03)	White	1000
151-00228	PBM0C2	PBM		.25" (6.4)	.122" (3.1)	.26" (6.60)	.40" (10.16)	.08" (2.03)	Black	100
151-00229	PBM0M4	PBM		.25" (6.4)	.122" (3.1)	.26" (6.60)	.40" (10.16)	.08" (2.03)	Black	1000

Dimensions are approximate and subject to technical changes. Use **Part No.** for ordering and **Type** for specification purposes.

Cable Tie Anchor Mounts

Cable ties may be inserted from any of the four sides of the CTAM. This feature allows the mount to be placed either parallel or perpendicular to the wires.

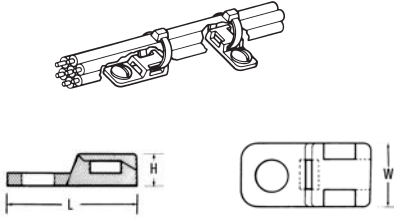

Material Data	
Material	Polyamide 6.6 (PA66)
Operating Temperature	-40 °F to +185 °F (-40 °C to +85 °C) continuous
Flammability	UL94 V2



US
File# E64139

Product Selection									
Article No.	Part No.	Type	Cable Tie Series	Mounting	Width (W)	Length (L)	Height (H)	Color	Pkg. Qty.
					in. (mm)	in. (mm)	in. (mm)		
151-31103	CTAM110C2	CTAM1	T18 - T50	#8 screw	.400" (10.16)	.800" (20.32)	.200" (5.08)	White	100
151-31106	CTAM110M4	CTAM1			.400" (10.16)	.800" (20.32)	.200" (5.08)	White	1000
151-31101	CTAM10C2	CTAM1			.400" (10.16)	.800" (20.32)	.200" (5.08)	Black	100
151-00287	CTAM10M4	CTAM1			.400" (10.16)	.800" (20.32)	.200" (5.08)	Black	1000
151-31203	CTAM210C2	CTAM2		#10 screw	.400" (10.16)	.800" (20.32)	.200" (5.08)	White	100
151-31205	CTAM210M4	CTAM2			.400" (10.16)	.800" (20.32)	.200" (5.08)	White	1000
151-31201	CTAM20C2	CTAM2			.400" (10.16)	.800" (20.32)	.200" (5.08)	Black	100
151-31202	CTAM20M4	CTAM2			.400" (10.16)	.800" (20.32)	.200" (5.08)	Black	1000

Dimensions are approximate and subject to technical changes. Use **Part No.** for ordering and **Type** for specification purposes.

Cable Tie Anchor Plates

These plates have slotted mounting holes to provide for easier alignment of mount and bundles. Once aligned, they are fastened securely by tightening the applied screw. The CTAP2 allows an additional screw for maximum stability. Both plates are used perpendicularly to the wire bundle.

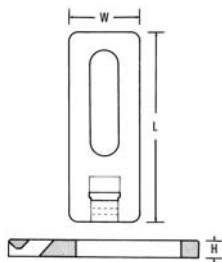

Material Data	
Material	Polyamide 6.6 (PA66)
Operating Temperature	-40 °F to +185 °F (-40 °C to +85 °C) continuous
Flammability	UL94 V2



US
File# E64139

Product Selection									
Article No.	Part No.	Type	Cable Tie Series	Mounting	Width (W)	Length (L)	Height (H)	Color	Pkg. Qty.
					in. (mm)	in. (mm)	in. (mm)		
151-30100	CTAP110C2	CTAP1	T18 - T50	#10 screw	.50" (12.7)	1.34" (34.04)	.15" (3.81)	White	100
151-00288	CTAP110M4	CTAP1			.50" (12.7)	1.34" (34.04)	.15" (3.81)	White	1000
151-00289	CTAP10C2	CTAP1			.50" (12.7)	1.34" (34.04)	.15" (3.81)	Black	100
151-00290	CTAP10M4	CTAP1			.50" (12.7)	1.34" (34.04)	.15" (3.81)	Black	1000
151-30200	CTAP210C2	CTAP2			.50" (12.7)	2.13" (54.1)	.14" (3.5)	White	100
151-00308	CTAP210H4	CTAP2			.50" (12.7)	2.13" (54.1)	.14" (3.5)	White	500
151-00291	CTAP20C2	CTAP2			.50" (12.7)	2.13" (54.1)	.14" (3.5)	Black	100
151-00292	CTAP20M4	CTAP2			.50" (12.7)	2.13" (54.1)	.14" (3.5)	Black	500

Dimensions are approximate and subject to technical changes. Use **Part No.** for ordering and **Type** for specification purposes.

Cable Tie Mounts

Lashing Tie Mounts

The lashing tie mount is designed to snap into the T250 lashing tie. The tie head is assembled perpendicular to the mount. The strap is parallel to the mount when inserted into the head. The lashing tie mount is recommended for indoor or outdoor wall mount cable applications.

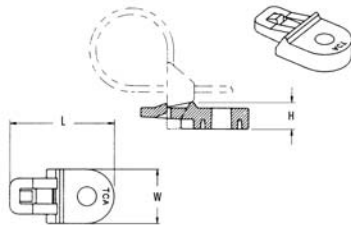

Material Data	
Material	Polyamide 6.6 UV-resistant (PA66UV)
Operating Temperature	-40 °F to +185 °F (-40 °C to +85 °C) continuous
Flammability	UL94 V2



Product Selection

Article No.	Part No.	Type	Cable Tie Series	Mounting	Width (W)	Length (L)	Height (H)	Color	Pkg. Qty.
					in. (mm)	in. (mm)	in. (mm)		
151-00358	LTM2500C2	LTM250	T250	.25" screw	.733" (18.62)	1.46" (37.08)	.378" (9.60)	Black	100
151-00293	LTM2500H4	LTM250			.733" (18.62)	1.46" (37.08)	.378" (9.60)	Black	500

Dimensions are approximate and subject to technical changes. Use **Part No.** for ordering and **Type** for specification purposes.

Masonry Mounts

Masonry mounts provide a permanent method of attaching wire and cable to masonry surfaces. HellermannTyton's masonry mounts simply tap into predrilled holes and can be used for indoor and outdoor applications.

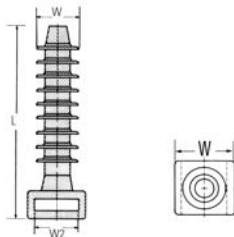

Material Data	
Material	Polyamide 6.6 (PA66)
Operating Temperature	-40 °F to +185 °F (-40 °C to +85 °C) continuous
Flammability	UL94 V2



Product Selection

Article No.	Part No.	Type	Cable Tie Series	Mounting Hole Ø	Min. Depth	Length (L)	Width (W)	Width (W2)	Width (W3)	Color	Pkg. Qty.
				in. (mm)	in. (mm)	in. (mm)	in. (mm)	in. (mm)	in. (mm)		
151-29800	MMB00C2	MMB0	T18 - T50	.188" (4.7)	1.0" (25.4)	1.185" (30.1)	.355" (9.02)	.218" (5.54)	.236" (5.99)	Black	100
151-00325	MMB00M4	MMB0		.188" (4.7)		1.185" (30.1)	.355" (9.02)	.218" (5.54)	.236" (5.99)	Black	1000
151-00116	MMB.50C2	MMB.5		.25" (6.25)		1.244" (31.60)	.375" (9.53)	.220" (5.59)	.308" (7.82)	Black	100
151-30001	MMB.50M4	MMB.5		.25" (6.25)	1.244" (31.60)	.375" (9.53)	.220" (5.59)	.308" (7.82)	Black	1000	
151-00326	MMB10C2	MMB1		.312" (8.0)	1.5" (38.10)	1.71" (43.49)	.508" (12.9)	.374" (9.50)	.362" (9.19)	Black	100
151-00327	MMB10H4	MMB1		.312" (8.0)		1.71" (43.49)	.508" (12.9)	.374" (9.50)	.362" (9.19)	Black	500

Dimensions are approximate and subject to technical changes. Use **Part No.** for ordering and **Type** for specification purposes.

Cable Tie Mounting Plates

Allowing multiple cables to be run in parallel, these mounting plates are secured with two screws. The cables are attached to the mounting plate by using a cable tie through any combination of the available slots.

Material Data	
Material	Polyamide 6.6 (PA66)
Operating Temperature	-40 °F to +185 °F (-40 °C to +85 °C) continuous
Color	Natural
Flammability	UL94 V2

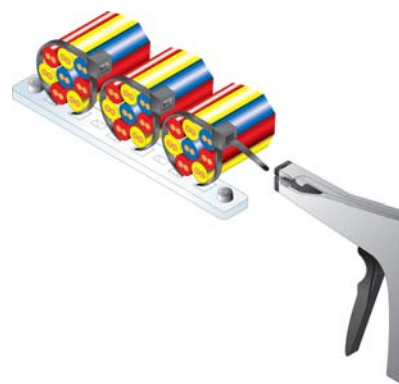
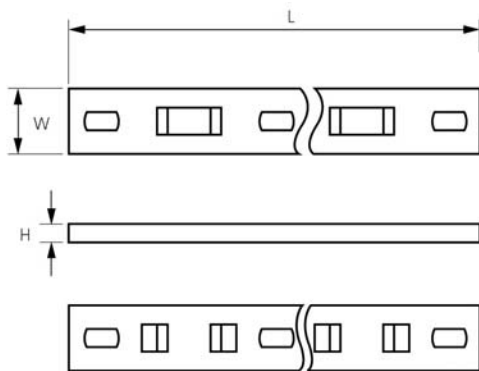
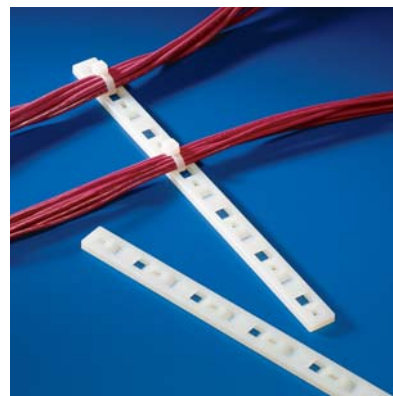

Product Selection			Cable Tie Series	Mounting	Width (W)		Length (L)		Height (H)		Pkg. Qty.
Article No.	Part No.	Type			in.	(mm)	in.	(mm)	in.	(mm)	
154-00000	MP1M3.NN3P	MP1M3	T18 - T50	# 6 (M3) screw	.50"	(12.7)	1.75"	(44.4)	.125"	(3.2)	100
154-00100	MP1M5.NN3P	MP1M5		#10 (M5) screw	.50"	(12.7)	1.75"	(44.4)	.125"	(3.2)	100
151-24219	MP2M3.NN3P	MP2M3		# 6 (M3) screw	.50"	(12.7)	3.00"	(76.2)	.125"	(3.2)	100
154-00300	MP2M5.NN3P	MP2M5		#10 (M5) screw	.50"	(12.7)	3.00"	(76.2)	.125"	(3.2)	100
151-24319	MP3M3.NN3P	MP3M3		# 6 (M3) screw	.50"	(12.7)	4.25"	(108.0)	.125"	(3.2)	100
154-00500	MP3M5.NN3P	MP3M5		#10 (M5) screw	.50"	(12.7)	4.25"	(108.0)	.125"	(3.2)	100
151-24419	MP4M3.NN3P	MP4M3		# 6 (M3) screw	.50"	(12.7)	5.50"	(139.8)	.125"	(3.2)	100
154-00700	MP4M5.NN3P	MP4M5		#10 (M5) screw	.50"	(12.7)	5.50"	(139.8)	.125"	(3.2)	100
151-24519	MP5M3.NN3P	MP5M3		# 6 (M3) screw	.50"	(12.7)	6.75"	(171.6)	.125"	(3.2)	100
154-00900	MP5M5.NN3P	MP5M5		#10 (M5) screw	.50"	(12.7)	6.75"	(171.6)	.125"	(3.2)	100
154-00018	MSMP5/69C2	MSMP5/6		# 6 (M3) screw	.618"	(15.7)	8.08"	(205.3)	.21"	(5.33)	100
154-01200	MSMP5/109C2	MSMP5/10		#10 (M5) screw	.618"	(15.7)	8.08"	(205.3)	.21"	(5.33)	100
154-01302	MSMP6/69C2	MSMP6/7		# 6 (M3) screw	.618"	(15.7)	9.58"	(243.3)	.21"	(5.33)	100
154-01300	MSMP6/109C2	MSMP6/10		#10 (M5) screw	.618"	(15.7)	9.58"	(243.3)	.21"	(5.33)	100

Dimensions are approximate and subject to technical changes. Use **Part No.** for ordering and **Type** for specification purposes.

Mechanical Cable Tie Tools



Ranging from the high performance Mark 7 and Mark 9 series tools to pocket-sized twist tools, HellermannTyton offers a range of mechanical tools which can be used with any HellermannTyton cable tie. When using these tools, the cable tie is hand applied and then manually tensioned and cut-off, without the use of an extraneous power source.

MARK 7 AND MARK 9 TOOLS

Specifically developed for maximum ergonomic and performance values, the Mark 7 and Mark 9 series tools combine reduced hand effort and durable components to ensure efficient assembly and a longer life cycle. The Mark 7 tools are used with T18 through T50 series HellermannTyton cable ties. The Mark 9 tools can be used with nearly every HellermannTyton cable tie. Able to accommodate ties to .530" in width, the Mark 9 is used with HellermannTyton's T18 series cable ties to the heavy duty ties, including the T250 series, Wide Strap series and EL-TY. High tension versions of both the Mark 7 and Mark 9 tools (MK7HT and MK9HT) offer the same design features as their standard counterparts but with higher cut-off tension capabilities. The Mark 9 and Mark 7 high tension tools both offer a 5/8" stroke.



MK7 & MK9

Mark 7 and Mark 9 Features

- An easy to read display speeds adjustment and verification.
- Thumb tab on larger tension knob for easy adjustment.
- On the Mark 7, a larger knob sets the three variable tension levels (minimum, intermediate, and standard). The smaller knob fine tunes within the tension range.
- The larger knob on the Mark 9 sets to two variable tension levels (standard and heavy). The smaller knob fine tunes the tension setting.
- Housings are manufactured from a high impact, glass reinforced nylon.
- A double wall linkage adds more strength.
- Tough chromium steel components ensure longevity.
- MK7 & MK9 are military specified.
- Single and dual lock-out features available for tensioning ranges.
- Cable tie tension and cut-off tools reduce operator fatigue and speed assembly.
- The Mark 7 features a one inch stroke, while the Mark 9 has a 5/8 inch stroke. Both reduce trigger cycles required to install cable ties.
- Ergonomic design on both tools ideally fit the operator's hand. Removable padded hand grips further reduce impact to the hand.
- Low friction bearing mechanisms reduce hand effort and provide a smooth stroke.
- Extremely light, the Mark 7 weighs only 10 ounces. The Mark 9 weighs just 13 ounces.
- Quick tension adjustability for flush cut-off.



MK7

Mark 7 Tool

Product Selection					
Article No.	Part No.	Type	Description	Cable Tie Series	Pkg. Qty.
110-07500	MK7	MK7	Durable and lightweight, the Mark 7 tool is user friendly and adjustable, with top-of-the-line design features.	T18 thru T50 Series CTT20 thru CTT60 Series	1
110-07000	MK7HT	MK7HT	The Mark 7 High Tension tool has the same design features as the MK7, although this tool offers an increased tension range.	T30 thru T50 Series CTT20 thru CTT60 Series	1
110-08000	MK7LK	MK7LK	The Mark 7 Lock-Out tool has the same design features as the MK7, although this tool offers complete lock-out of tension settings.	T30 thru T50 Series CTT20 thru CTT60 Series	1
110-00448	MK7BLADEKIT	MK7BLADEKIT	Service kit for MK7 tool includes replacement blade, screw for nose piece, and instruction card.		1
110-00449	MK7-449	MK7-449	Replacement blade for MK7 series tools.		1

Dimensions are approximate and subject to technical changes. Use **Part No.** for ordering and **Type** for specification purposes.
Minimum order quantity for the MK7-449 is 5.

Cable Tie Tools

Mark 9 Tool



MK9



MK9SST

Product Selection					
Article No.	Part No.	Type	Description	Cable Tie Series	Pkg. Qty.
110-09500	MK9	MK9	The Mark 9 tool has the same design features as the MK7 series tools. The MK9 accommodates heavy duty cable ties.	T18* thru T250 Series CTT20 thru CTT175 Series EL-TY Series Wide Strap Series	1
110-09000	MK9HT	MK9HT	The Mark 9 High Tension tool has the same design features as the MK9, but offers an increased tension range.	T18* thru T250 Series CTT20 thru CTT175 Series EL-TY Series Wide Strap Series	1
110-09700	MK9RE	MK9RE	The MK9 Rounded Edge tool has the same design features as the MK9 although it has a special nose piece that leaves a 2mm round tail.	T18* thru T250 Series CTT20 thru CTT175 Series EL-TY Series Wide Strap Series	1
110-09600	MK9REF	MK9REF	The Mark 9 Reduced Effort tool has a reduced effort trigger mechanism for operators with small hands. It has a shorter pawl stroke.	T18* thru T250 Series CTT20 thru CTT175 Series EL-TY Series Wide Strap Series	1
110-95000	MK9SST	MK9SST	Adapted for use with stainless steel ties, the MK9 Stainless Steel tool retains the same design features as the MK9 series. The MK9SST accommodates all HellermannTyton stainless steel ties.	All MBT Series for both 304 and 316 materials	1
110-00220	MK9BLADEKIT	MK9BLADEKIT	Service kit for the MK9 tool includes replacement blade, screw for nose piece, and instruction card.		1
110-00221	MK9-221	MK9-221	Replacement blade for MK9 series		1
110-05114	MK9SS-114	MK9SS-114	Replacement blade for MK9SST series tools		1

Dimensions are approximate and subject to technical changes. Use **Part No.** for ordering and **Type** for specification purposes. * Does not include T18S series ties .08" wide.

Other Mechanical Cable Tie Tools

Product Selection					
Article No.	Part No.	Type	Description	Cable Tie Series	Pkg. Qty.
110-21000	TWT1	TWT	The TytonTwyster is a lightweight and economical twist tool. Offers speed and efficiency. Fits into a pocket. (Color Orange)	T18 thru T50 Series CTT20 thru CTT60 Series	1
110-22000	TWT2	TWT	The TytonTwyster is a lightweight and economical twist tool. Offers speed and efficiency. Fits into a pocket. (Color Blue)	T120 thru T150 Series CTT175 Series	1
110-11150	T150	T150	The T150 Tool is a heavy duty installer controlled tool for use in the field. Pliers action provides mechanical advantage. Padded foam grip handles provide comfort and control.	T150 Series CTT175 Series	1
110-11250	T250	T250	The T250 has the same design features as the T150 Tool, but can tension and cutoff a wider tie.	T150 thru T250 Series CTT175 Series	1

Dimensions are approximate and subject to technical changes. Use **Part No.** for ordering and **Type** for specification purposes.

Power Assisted Cable Tie Tools

HellermannTyton's Mark 7 and Mark 9 power assisted (MK7P & MK9P) tools utilize pneumatic power to tension and cut-off HellermannTyton cable ties. The MK7P and MK9P tools feature an ergonomic design while offering time/labor savings and ease of use benefits derived from pneumatic power. These tools feature a non-slip, comfortable grip, soft touch trigger, and one touch tensioning/cut-off capability. HellermannTyton's pneumatic cable tie tools are lightweight, high performance, and suited for extended use.

Product Features

- Ergonomic

The ergonomic design of the pneumatic cable tie tools incorporates a comfortable grip, low weight, and easy trigger depression to reduce installer effort and strain while installing cable ties.

- Operation

MK7P & MK9P speed assembly. Just one pulse of the soft touch trigger assembly actuates an immediate tension and cut-off of the cable tie.

- Cable tie waste is ejected to the side after the cable tie is applied, ensuring smooth operation of the tool.
- Uses dry or lubricated air.
- Operates between 90 PSI and 105 PSI maximum.
- Supplied with a 6 inch lead which comes with a male quick connect fitting with a female coupler for 1/8" flow.

- Design

HellermannTyton's pneumatic tools are manufactured with tough, chromium steel components and high impact, glass reinforced nylon housings for maximum durability.

- Tensioning

An easy to read indicator verifies tension settings. The tools feature an easy dial-in tension adjustment, along with a lock-out capability. The tension adjustment on the MK7P and the MK9P is designed with an operator friendly, positive "click" design for easy use. The tension can readily be locked out to allow the tension adjustment to remain at a constant setting that can only be changed by approved personnel. The fine adjust tension knob has a unique lever feature used to reduce adjustment torque.



MK9P

Cable Tie Tools

Mark 7 Pneumatic

The Mark 7 Pneumatic (MK7P) is built to perform in demanding production and manufacturing environments. Heavy duty precision parts ensure repeatability in the tensioning process. The MK7P fits comfortably in the operator's hand, reducing hand, arm and wrist fatigue. Due to its ergonomic features, HellermannTyton's MK7P makes it easier for the installer to consistently apply cable ties while maintaining correct tension and flush cut-off. Safety is enhanced, as the MK7P can eliminate sharp edges of a cut-off cable tie.



MK7P

Material Data	
Power Supply	Dry or lubricated air
Cycle Time	4 strokes per second
Weight	16oz
Pawl Travel Stroke	1.0" (2.54 cm)
Tension Force	60 to 170 N, adjustable

Product Selection					
Article No.	Part No.	Type	Description	Cable Tie Series	Pkg. Qty.
110-07101	MK7P	MK7P	Includes Mark 7 Pneumatic tool and quick connect fittings. Ergonomic tool uses pneumatic power and accomplishes rapid tension and cut-off with one trigger depression.	T18 thru T50 Series CTT20 thru CTT60 Series	1
110-07111	MK7P-342	Replacement Blade	MK7P Replacement Blade		1

Dimensions are approximate and subject to technical changes. Use **Part No.** for ordering and **Type** for specification purposes.

Minimum order quantity for MK7P-342 is 5.

MK9 Pneumatic

The Mark 9 Pneumatic (MK9P) is constructed with heavy duty parts to ensure that it performs optimally in demanding environments. It is ideally designed to apply heavy-duty ties (T50-T250), clamp and button head ties.

Like the MK7P, HellermannTyton's MK9P incorporates the next level of ergonomic improvement with its low weight, comfortable grip and easy trigger depression. Very durable, the pneumatic MK9P features adjustable, easy to read tension settings. Lock-out features are available.

The MK9P is available with lower air attachment (standard) or can be ordered with an upper air attachment.

Material Data	
Power Supply	Dry or Lubricated Air
Cycle Time	2 strokes per second
Weight	32oz
Pawl Travel Stroke	1.25" (3.175 cm)
Tension Force	60 to 170 N, adjustable



MK9PUA (Upper Air)



MK9P

Product Selection					
Article No.	Part No.	Type	Description	Cable Tie Series	Pkg. Qty.
110-09101	MK9P	MK9P	Includes Mark 9 Pneumatic tool and quick connect fittings. Included is a 1/8" flow quick disconnect fitting and a 10" whip and 1/8" make fitting. Ergonomic tool uses pneumatic power and accomplishes rapid tension and cut-off with one trigger depression.	T50 thru T250 Series CTT20 thru CTT175 Series EL-TY Series Button Head Ties	1
110-09112	MK9PUA	MK9P	Includes Mark 9 Pneumatic tool with upper air option for top air connection. Supplied with a 1/8" flow quick disconnect fitting and a 10" whip and 1/8" quick disconnect fitting. Includes a hanger for an optional overhead tool balancer (not included). Ergonomic tool uses pneumatic power and accomplishes rapid tension and cut-off with one trigger depression.	T50 thru T250 Series CTT20 thru CTT175 Series EL-TY Series Button Head Ties	1
110-09111	MK9P-109	MK9P-109	MK9P Replacement Blade		1**

Dimensions are approximate and subject to technical changes. Use **Part No.** for ordering and **Type** for specification purposes.

**Minimum order quantity of MK9P-109 is 5.

Common Accessories for MK7P and MK9P

HellermannTyton offers a portable kit that incorporates carbon dioxide (CO₂) as the primary air source. This unique feature will allow for greater flexibility and the elimination of air line to the tool.

Product Selection					
Article No.	Part No.	Type	Description	Pkg. Qty.	
110-09002	MKPCOKIT	MKPCOKIT	MKPCOKIT is a complete kit that includes the belt, holster, hose/regulator, pouch and 16oz air tank.	1	
110-09003	MKPCOTANK	MKPCOTANK	Standard 16oz air tank for CO ₂ air supply to tool.	1	
110-09004	MKPCOTANK20	MKPCOTANK20	Special 20oz canister tank for CO ₂ feature.	1	
110-09005	MKPCOHOSE	MKPCOHOSE	Hose attachment from air tank to the tool with regulator.	1	
110-09006	MKPCOBELT	MKPCOBELT	Adjustable belt for air tank and pouch and tool holster for MK7P or MK9P tools.	1	

Dimensions are approximate and subject to technical changes. Use **Part No.** for ordering and **Type** for specification purposes.

Automatic Cable Tie Systems

HellermannTyton's automatic cable tie tool systems are compact, fast, reliable, and versatile, accommodating a variety of wiring harness, and bundling and securing requirements. These tool systems are designed to provide significant labor and cost savings through process improvements, lower installed costs and greater consistency, quality and ergonomic benefits.

Product Features

- **Fast**
Cable ties are installed quickly with one easy trigger depression, increasing productivity while decreasing labor costs.
- **Reliable**
HellermannTyton's automatic cable tie systems have been tested to perform extremely consistently without interruption to work flow.
- **Ergonomic**
The ergonomic design of the automatic cable tie tool systems feature a comfortable grip, low weight, and easy trigger depression to reduce installer effort and strain while installing cable ties.
- **Easy to Use - Providing Valuable Operator Feedback**
Equipped with a self-diagnostic LED information panel, the automatic cable tie systems easily guide the user through the cycles of cable tie installations.
- **Automation**
The automatic cable tie systems can be implemented into fully automated applications to further increase productivity and decrease labor costs.
- **Flexible Manufacturing/Versatility**
HellermannTyton's automatic cable tie tool systems support principles of flexible manufacturing requirements and environments. The systems can be used in handheld, bench mount and overhead assembly configurations. The versatile overhead assembly option provides the ultimate integration to the customer's manufacturing area. HellermannTyton's automatic tools are powered by a standard 110 AC 24V (AT2000) and 110 AC 27 V (AT2060) electrical outlet that converts to a low DC voltage to the tool. All power systems offer the installer the mobility needed to tackle different harnessing requirements.
- **Uniform Fastening Quality**
HellermannTyton's automatic cable tie systems feature adjustable tension control to deliver consistent levels of cable tie fastening.
- **Range**
HellermannTyton offers the widest range of automatic cable tie tool systems which cover cable tie tensile strengths of 18, 30, and 50 pounds with bundle diameters between 1/16" to over 3".



ATS3080



An LED panel shows the status of the tool.

Product Selection		
Article No.	Part No.	Max. Ø Bundle
120-00000	AT2000	.75" (20 mm)
103-00000	AT2060	1.25" (31 mm)
102-00000	ATS3080	3.14" (80 mm)

AT2000
For bundles up to 3/4"

HellermannTyton's AT2000 completely installs cables ties on bundles up to 3/4" in diameter. This automatic cable tie tool is highly reliable and offers ergonomic benefits including low weight, easy trigger depression, a comfortable hand grip and correct balance—all which reduce operator strain. The AT2000 possesses an LED panel which makes it easier to maintain and operate the tool.



AT2000 Technical Specifications	
Power Supply	Electrical, with Power Pack or Battery Pack
Cycle Time	0.8 s
Weight	2.6lbs
Installation	Handheld, bench mount or overhead
Tension Force	Adjustable

AT2000 Cable Tie Specifications	
Operating Temperature	
Natural Polyamide 6.6	-40 °F to +185 °F (-40 °C to +85 °C) continuous
Heat stabilized, black Polyamide 6.6	-40 °F to +221 °F (-40 °C to +105 °C) continuous
Natural, Stanyl Polyamide 4.6	-40 °F to +275 °F (-40 °C to +135 °C) continuous
Reel Diameter	17.7 " (450)
Reel Width	5.20 " (132)

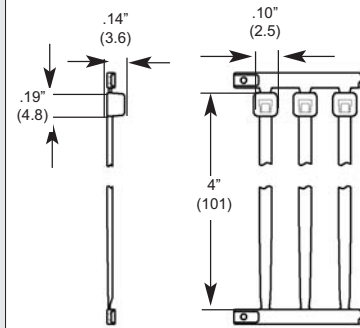

AT2000 Cable Ties



Product Selection

Article No.	Part No.	Type	Description	Min. Tensile Strength	Max. Ø Bundle	Pkg. Qty.
				lbs. (N)	in. (mm)	
120-00000	AT2000	Autotool 2000	Includes AT2000 tool, power supply, power cord, tool cord, and manual			1
120-00060	120-00060	Control Box	Control Box for linking AT2000 to automation			1

Natural Cable Ties

120-40009	T18RA50	T18RA50-N66-NA	Cable ties on bandolier for use with the AT2000	18 lbs (80)	.75" (20)	20,000 per carton includes: 50 per bandolier 500 per package
120-46009	T18RA3500	T18RA3500-N66-NA	Cable ties on reel for use with the AT2000	18 lbs (80)	.75" (20)	14,000 per carton includes: 3,500 per reel 4 reels per carton
120-05009	T18RA5000	T18RA5000-N66-NA	Cable ties on reel for use with the AT2000	18 lbs (80)	.75" (20)	10,000 per carton includes: 5,000 per reel 2 reels per carton

Black, Heat Stabilized Cable Ties

120-40010	T18RA50HSW	T18RA50-HSW-BK	Cable ties on bandolier for use with the AT2000	18 lbs (80)	.75" (20)	20,000 per carton includes: 50 per bandolier 500 per package
120-05010	T18RA5000HSW	T18RA5000-HSW-BK	Cable ties on reel for use with the AT2000	18 lbs (80)	.75" (20)	10,000 per carton includes: 5,000 per reel 2 reels per carton

Natural, Stanyl Cable Ties

120-04609	T18RA5000HR	T18RA5000HR-N46	Cable ties on reel for use with the AT2000	18 lbs (80)	.75" (20)	10,000 per carton includes: 5,000 per reel 2 reels per carton
-----------	--------------------	-----------------	--	-------------	-----------	---

V/O rated ties can be made available for the AT2000. Various tie colors available upon request (Contact HellermannTyton for lead time). Dimensions are approximate and subject to technical changes. Use **Part No.** for ordering and **Type** for specification purposes.

For information on AT2000's Bench Mount System and Overhead Suspension Assembly see page 75–76.

For information on Wire Retainers for Harness Boards and AT2000's battery pack see page 77.

Cable Tie Tools

AT2060

HellermannTyton's AT2060 automatically installs cable ties for bundles up to 1-1/4". The many ergonomic benefits include easy trigger depression and low weight that reduces operator effort and strain. Operation and maintenance of the tool are enhanced by the self-diagnostic LED panel located on the AT2060.



AT2060 Technical Specifications	
Power Supply	Electrical
Cycle Time	1.2 seconds
Weight	3.9lbs
Pawl Travel	1.25"
Stroke	(3.175 cm)
Tension Force	Adjustable

AT2060 Cable Tie Specifications	
Operating Temperature	
Natural Polyamide 6.6	-40 °F to +185 °F (-40 °C to +85 °C)
Heat stabilized, black, Polyamide 6.6	-40 °F to +221 °F (-40 °C to +105 °C)
Reel Diameter	17.7 " (450)
Reel Width	7.197 " (182.8)
Reel Weight	7 lbs

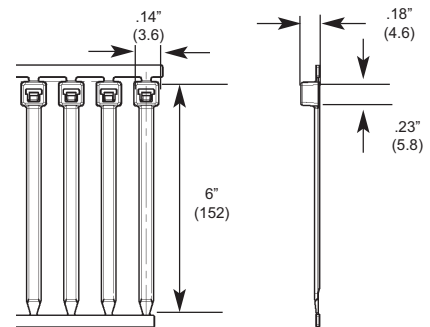

Product Selection						
Article No.	Part No.	Type	Description	Min. Tensile Strength	Max. Ø Bundle	Pkg. Qty.
				lbs. (N)	in. (mm)	
103-00000	AT2060	AT2060	Includes AT2060 tool, power supply, power cord, tool cord, and maintenance and operation manual.			1

Natural Cable Ties

103-00002	T30RA30	T30RA	Cable ties on a bandolier for use with the AT2060 tool	30 lbs (133.44)	1.25" (31)	6,000 per carton includes: 30 per bandolier 600 per bag
103-00001	T30RA3000	T30RA3000	Cable ties on a reel for use with the AT2060 tool	30 lbs (133.44)	1.25" (31)	6,000 per carton includes: 3,000 per reel 2 reels per carton

Black, Heat Stabilized Cable Ties

103-00003	T30RA300HS	T30RA	Cable ties on a bandolier for use with the AT2060 tool	30 lbs (133.44)	1.25" (31)	6,000 per carton includes: 30 per bandolier 600 per bag
103-00004	T30RA3000HS	T30RA	Cable ties on a reel for use with the AT2060 tool	30 lbs (133.44)	1.25" (31)	6,000 per carton includes: 3,000 per reel 2 reels per carton

Dimensions are approximate and subject to technical changes. Use **Part No.** for ordering and **Type** for specification purposes. V/O rated ties and 4/6 ties for high temperatures can be made available for the AT2060. Various colors available upon request (Contact HellermannTyton for lead time).

For information on AT2060's Bench Mount System and Overhead Suspension Assembly see page 75-76

For information on Wire Retainers for Harness Boards see page 77

AT2000 & AT2060 Bench Mount System

HellermannTyton offers a portable bench mount system which works with the AT2000 and AT2060 tool systems. It is extremely easy to set up and use. Within seconds, the AT2000 or the AT2060 can be converted from a handheld tool to a bench mount system. With the touch of the foot pedal, the cable tie is applied.



AT2000 and AT2060 Bench Mount System

Product Selection				
Article No.	Part No.	Type	Description	Pkg. Qty.
120-00040	AT2BENCHMOUNT	Bench Mount Kit	Includes foot pedal, tie reel stand and tool mounting stand	1

Use **Part No.** for ordering and **Type** for specification purposes.

AT2000 or AT2060 Overhead Suspension Assembly

HellermannTyton's overhead suspension assembly system holds the AT2000 or AT2060, reel of cable ties, and power source. The overhead assembly is available in several configurations in a variety of mounting options and is easily integrated into various manufacturing environments. The modular design allows for easy additions or modifications of the system design.

The overhead assembly system provides additional ergonomic advantages to the AT2000 and AT2060. The system features overhead hanging, a trolley slide which allows for mobility within the frame, and an adjustable counter balance. These features allow for low operator strain and easy use. Since the assembly integrates the automatic cable tie systems and reel of ties, continuous feed is achieved. Reloading of cable ties is greatly reduced, further optimizing efficiencies.



The picture shows just one configuration of an overhead assembly.

The HellermannTyton team of tool systems specialists will assist in the custom design of a system to specially accommodate individual manufacturing sites and production needs. The modular features and inherent ergonomic benefits improve production and make operation more efficient.

Contact HellermannTyton for more information. Fasteners for unit assembly are included. Permanent mounting fasteners are not included.



Mobile Trolley Unit Configuration

AT2000 Battery Pack

HellermannTyton's battery pack powers the AT2000 and is worn by the operator, allowing for complete mobility.



Product Selection				
Article No.	Part No.	Type	Description	Pkg. Qty.
120-00030	AT06500030	Battery Pack	Battery with belt clip and connector cord	1
120-00010	AT06500020	Battery Charger	Charging unit for battery	1

Dimensions are approximate and subject to technical changes. Use **Part No.** for ordering and **Type** for specification purposes.

Wire Retainer for Harness Boards

Designed for use in harness board assemblies, these wire retainers stand-off wire and cable bundles for easier cable tie application. Wires are individually inserted, and bundles are preformed, making harnessing easier.



Wire Retainer for Harness Boards

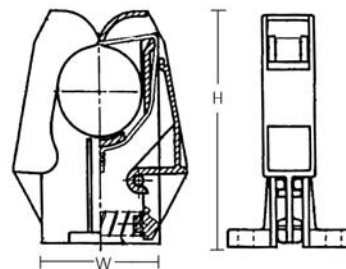

Product Selection							
Article No.	Part No.	Type	Description	Height (H)	Width (W)	Max. Ø Bundle	Pkg. Qty.
				in. (mm)	in. (mm)	in. (mm)	
120-00080	HH-20	HH20	Harness Board Assembly	2.12" (54)	1.22" (31)	.83" (20)	25

Dimensions are approximate and subject to technical changes. Use **Part No.** for ordering and **Type** for specification purposes.

AutoTool System 3080
For bundles up to 3.14"

HellermannTyton's ATS3080 automatically installs cable ties for bundles up to 3.14" in diameter with one trigger depression. This innovative system utilizes strap and closures (ordered separately) to achieve a waste free system. The ATS3080 uses only the required strap length required for the diameter. The strap is outside serrated so that it will not damage sensitive wire and cable bundles.

This well balanced tool has ergonomic benefits that include low weight and a comfortable hand grip which reduces operator strain and injury while installing cable ties. The ATS3080 possesses a LED panel that provides critical operational feedback that makes it easier to maintain and operate the tool.

The ATS3080 has three jaw diameters available; 1.18" (30mm), 1.96" (50mm), and 3.14" (80mm). The jaws are easily interchanged and further tool adjustment between the three jaw diameters is unnecessary.



ATS3080 Technical Specifications

Power Supply	Electrical
Cycle Time	approx. 1.3 sec. (50 mm jaw)
Weight	3.2lbs
Installation	Mobile, bench mount or overhead
Tension Force	Adjustable



Closures and strap for ATS3080



ATS3080 Cable Tie Specifications

Material	Polyamide 6.6 high impact modified, heat and UV stabilized (PA66HIRHSUV)
Operating Temperature	-40 °C to +95 °C continuous, (+105 °C for 5000 h)
Flammability	UL94 HB
Strap Reel Dimensions	
Reel Diameter	15.25" (387 mm)
Reel Width	3.5" (88.9 mm)
Reel Weight	6lbs (2.72 kg)
Closure Reel Dimensions	
Reel Diameter	15.25" (387 mm)
Reel Width	3.5" (88.9 mm)
Reel Weight	3.5lbs (1.58 kg)





ATS3080 with mobile trolley unit



ATS3080 with overhead



ATS3080 with bench mount

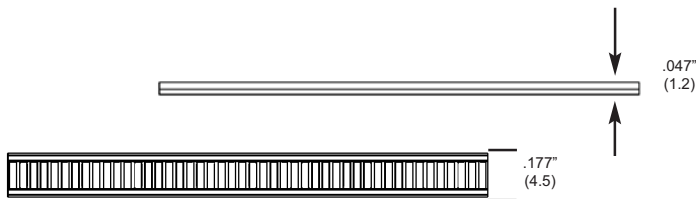

Strap ATS3080

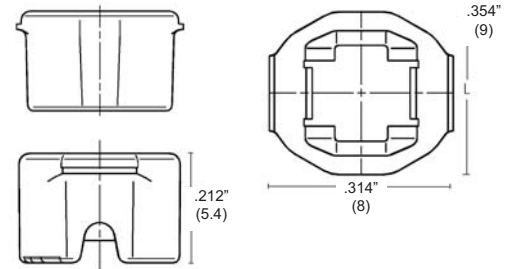

Closures ATS3080

Product Selection

Article No.	Part No.	Type	Description	Min Tensile Unlocking Strength (lbs)	Pkg. Qty. ft. (m)
102-00000	ATS3080	ATS3080	Includes ATS3080 tool, power cord, tool cord, and maintenance and operation manual. Does not include power supply.		1
102-00010	ATS10200010	Power Pack ATS3080	Power Supply Unit for ATS3080 Input: 230/115 VAC, 50-60 Hz Output: 48 VDC, max. 50W		1
Natural Strap and Closures					
102-66109	ATS10266109	Strap Natural ATS3080	ATS3080 Strap	50 lbs	1640 ft. (500)
102-66209	ATS10266209	Closures Natural ATS3080	ATS3080 Closure	50 lbs	5000 pcs
Black Strap and Closures					
102-66110	ATS10266110	Strap Black ATS3080	ATS3080 Strap	50 lbs	1640 ft. (500)
102-66210	ATS10266210	Closures Black ATS3080	ATS3080 Closures	50 lbs	5000 pcs
102-00040	ATS10200040	Bench Mount Kit	Bench Mount Kit for ATS 3080 Integrated pneumatic system that coordinates tool and reels. Foot pedal application, other actuation options available		1
102-00050	ATS10200050	Overhead Suspender	Overhead Suspender ATS 3080		1
102-00030	ATSTROLLEY	Trolley ATS 3080	Trolley		1

Dimensions are approximate and subject to technical changes. Use **Part No.** for ordering and **Type** for specification purposes.

Cable Tie Tools

Quick Tool

HellermannTyton's Quick Tool is an automatic bench mount system suited for high volume cable tie applications. This air powered tool accommodates a reel of 5,000 ties and, like HellermannTyton's other automated systems, can be integrated into further automation as well as fully incorporated into conveyor or assembly line applications.

Product Features

- The system is a one piece, bench top unit which increases efficiency through quick and reliable fastening.
- It can be installed where a 110 VAC electrical outlet and pneumatic air source are available.
- Provides consistent fastening tension.
- Controls fastening tension.
- Ties are available in two styles: standard and heat stabilized.
- Custom colors for Quick Tool ties are also available. Contact HellermannTyton for more information.



QS101 Cable Tie Specifications	
Operating Temperature	
Natural	-40 °F to +185 °F (-40 °C to +85 °C)
Polyamide 6.6	
Heat stabilized, black, Polyamide 6.6	-40 °F to +221 °F (-40 °C to +105 °C)
Reel Diameter	18" (457 mm)
Reel Width	5.20" (132 mm)
Reel Weight	4.8 lbs (2.18 kg)



QS101 Technical Specifications	
Max. Ø Bundle	0.630" (16.00 mm)
Wattage	70W
Power Supply	Electrical/Pneumatic Power
Cycle Time	1.2 Seconds
Weight	40 lbs.
Installation	Bench
Tension Force	Adjustable (9.92 lbs - 19.84 lbs)

Product Selection								
Article No.	Part No.	Type	Description	Min Tensile Unlocking Strength (lbs)	Max. Ø Bundle	Width (W)	Length (L)	Pkg. Qty.
					in. (mm)	in. (mm)	in. (mm)	
105-00000	QS101	QS101	Includes Quick Tool, power cord, maintenance and operation manual and foot pedal.					1
Natural Cable Ties								
105-00006	QTTIE9	QTTIE9	Cable ties on reel for use with the Quick Tool.	18	.63" (16)	.10" (2.5)	4.0" (101)	10,000 per carton: 5,000 per reel 2 reels per carton
Black Heat Stabilized Cable Ties								
105-00001	QTTIEOHS	QTTIEOHS	Cable ties on reel for use with the Quick Tool.	18	.63" (16)	.10" (2.5)	4.0" (101)	10,000 per carton: 5,000 per reel 2 reels per carton

Dimensions are approximate and subject to technical changes. Use **Part No.** for ordering and **Type** for specification purposes.

Various colored cable ties available upon request. Contact HellermannTyton for more information and lead times.