

T110 Series Axial MIL-PRF-39003 Polar Type and T212 (CSR13)

Overview

The KEMET standard hermetically sealed T110 Series is targeted for use in high humidity environments. These capacitors are ruggedly built, designed for miniaturized circuitry, and are especially well-suited for coupling, bypass, filtering and RC timing circuits. The T110 Series exhibits excellent stability as well as extremely low DC leakage current, dissipation factor, and

ESR/impedance over a wide temperature and frequency range. Available in standard EIA capacitance values from 0.0047 μF to 330 μF in $\pm 20\%$, $\pm 10\%$, and $\pm 5\%$ tolerances, the T110 Series is now offered in working voltages of 6 VDC to 125 VDC and low ESR limits. Higher CV values in comparable case sizes are available in the KEMET T410 Series.

Benefits

- Taped and reeled per EIA Specification RS-296
- Marking per MIL-STD-1285
- Qualified to MIL-PRF-39003, Style CSR13
- Failure rate options: Graded - B, C, D, and G
Exponential - M, P, R, and S*
- Capacitance values of 0.0047 μF to 330 μF
- Tolerances of $\pm 5\%$, $\pm 10\%$ and $\pm 20\%$
- Voltage rating of 6 – 125 VDC
- Operating temperature range of -55°C to $+125^\circ\text{C}$
- Case sizes: A, B, C, D

*Failure rates apply to military products only

Applications

Typical applications include coupling, bypass, filtering and RC timing circuits in miniaturized circuitry.



Ordering Information – T110

T	110	A	105	K	050	A	T	7200
Capacitor Class	Series	Case Size	Capacitance Code (pF)	Capacitance Tolerance	Voltage	Failure Rate	Lead Material	Specification
T = Tantalum	Hermetically Sealed Axial capacitor	A, B, C, D	First two digits represent significant figures. Third digit specifies number of zeros.	J = $\pm 5\%$ K = $\pm 10\%$ M = $\pm 20\%$	006 = 6 V 010 = 10 V 015 = 15 V 020 = 20 V 035 = 35 V 050 = 50 V 060 = 60 V 075 = 75 V 100 = 100 V 125 = 125 V	A = N/A	T = 100% Tin S = Standard (Sn/Pb)	All capacitors are sleeved unless specified 0100 = Without sleeve 7200 = Tape & Reel 7293 & 7443 = Ammo

Ordering Information – T212 (CSR13)

MIL product

T	212	A	105	K	050	B	S	7200
Capacitor Class	Series	Case Size	Capacitance Code (pF)	Capacitance Tolerance	Voltage	Failure Rate/ Military Product Only	Lead Material	Specification
T = Tantalum	Hermetically Sealed Axial Military grade capacitor	A, B, C, D	First two digits represent significant figures. Third digit specifies number of zeros.	J = $\pm 5\%$ K = $\pm 10\%$ M = $\pm 20\%$	006 = 6V 010 = 10V 015 = 15V 020 = 20V 035 = 35V 050 = 50V 075 = 75V 100 = 100V	Graded: B = 0.1%/k hours C = 0.01%/k hours D = 0.001%/k hours G = 1.0 %/k hours Exponential: M = 1%/k hours P = 0.1%/k hours R = 0.01%/k hours S = 0.001%/k hours	S = Standard (Sn/Pb)	All capacitors are sleeved unless specified 0100 = Without sleeve 7200 = Tape & Reel 7293 & 7443 = Ammo 4250="A" surge current 4251="B" surge current 4252="C" surge current

Ordering Information – T212 (CSR13)

MIL product

M39003	/01	6003	E
Capacitor Class	Slash	Dash Number	Surge Option
Military Specification Number	Specification Sheet Number	Failure Rate Level	D = C-4250 E = C-4251 F = C-4252 H = No C-Spec

Orders should be entered by the military specification number, including the dash number and surge option letter (D, E, F, or H).

Performance Characteristics

Item	Performance Characteristics
Operating Temperature	-55°C to 125°C
Rated Capacitance Range	0.0047 – 330 µF @ 120 Hz/25°C
Capacitance Tolerance	J Tolerance (5%), K Tolerance (10%), M Tolerance (20%)
Rated Voltage Range	6 – 125 V
DF (120 Hz @ 25°C)	Refer to Part Number Electrical Specification Table
ESR and Impedance (100 kHz @ 25°C)	Refer to Part Number Electrical Specification Table (for reference only)
Leakage Current	Refer to Part Number Electrical Specification Table (At rated voltage up to +85°C and 2/3 of rated voltage applied at 125°C)
Failure Rate (MIL-39003, CSR13 capacitors only)	Approved failure rate: S (0.001%/k hours) - Exponential, D (0.001%/k hours) and C (0.01%/k hours) - Graded

Dimensions – Millimeters (Inches)

Metric will govern

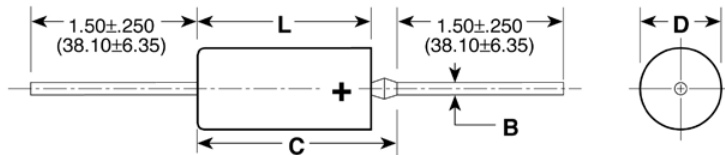

Case Size	Uninsulated		Insulated		B ±0.002 ±(.05)	C Maximum
	D ±0.005 ±(.13)	L ±0.031 ±(.79)	D ±0.010 ±(.25)	L ±0.031 ±(.79)		
A	0.125 (3.18)	0.250 (6.35)	0.135 (3.43)	0.286 (7.26)	0.020 (.51)	0.422 (10.72)
B	0.175 (4.45)	0.438 (11.13)	0.185 (4.70)	0.474 (12.04)	0.020 (.51)	0.610 (15.49)
C	0.279 (7.09)	0.650 (16.51)	0.289 (7.34)	0.686 (17.42)	0.025 (.64)	0.822 (20.88)
D	0.341 (8.66)	0.750 (19.05)	0.351 (8.92)	0.786 (19.96)	0.025 (.64)	0.922 (23.42)

Table 1 – Ratings & Part Number Reference

Rated Voltage	Rated Cap	Case Size Code	KEMET Part Number	DC Leakage	DF % @ 25°C	MIL-PRF-39003 (CSR13) Capacitors										KEMET Equivalent Military Part Number		
						Dash Number Reference												
						Failure Rate Level (%/1,000 hours)												
						MIL-PRF-39003/1K				MIL-PRF-39003/1K								
						Exponential				Graded								
VDC	µF		(See below for part options)	µA @ 25°C Max/5 Minutes	120 Hz Maximum	M (1.0)	P (0.1)	R (0.01)	S (0.001)	G (1.0)	B (0.1)	C (0.01)	D (0.001)	Part Number				
6	2.2	A	T110A225(1)006A(3)	0.3	4													
6	2.7	A	T110A275(1)006A(3)	0.3	4													
6	3.3	A	T110A335(1)006A(3)	0.3	4													
6	3.9	A	T110A395(1)006A(3)	0.3	4													
6	4.7	A	T110A475(1)006A(3)	0.3	4													
6	5.6	A	T110A565J006A(3)	0.3	4	5001	5201	5401	5601	4001	6001	7001	8001	T212A565J006(2)S				
6	5.6	A	T110A565K006A(3)	0.3	4	2241	2481	2721	2961	4002	6002	7002	8002	T212A565K006(2)S				
6	5.6	A	T110A565M006A(3)	0.3	4													
6	6.8	A	T110A685J006A(3)	0.3	6	5002	5202	5402	5602	4003	6003	7003	8003	T212A685J006(2)S				
6	6.8	A	T110A685K006A(3)	0.3	6	2242	2482	2722	2962	4004	6004	7004	8004	T212A685K006(2)S				
6	6.8	A	T110A685M006A(3)	0.3	6	2243	2483	2723	2963	4005	6005	7005	8005	T212A685M006(2)S				
6	8.2	B	T110B825(1)006A(3)	0.3	6													
6	10.0	B	T110B106(1)006A(3)	0.3	6													
6	12.0	B	T110B126(1)006A(3)	0.5	6													
6	15.0	B	T110B156(1)006A(3)	0.9	6													
6	18.0	B	T110B186(1)006A(3)	0.9	6													
6	22.0	B	T110B226(1)006A(3)	0.9	6													
6	27.0	B	T110B276(1)006A(3)	0.9	6													
6	33.0	B	T110B336(1)006A(3)	0.9	6													
6	39.0	B	T110B396(1)006A(3)	0.9	6													
6	47.0	B	T110B476J006A(3)	1.5	6	5003	5203	5403	5603	4006	6006	7006	8006	T212B476J006(2)S				
6	47.0	B	T110B476K006A(3)	1.5	6	2244	2484	2724	2964	4007	6007	7007	8007	T212B476K006(2)S				
6	47.0	B	T110B476M006A(3)	1.5	6	2245	2485	2725	2965	4008	6008	7008	8008	T212B476M006(2)S				
6	56.0	B	T110B566J006A(3)	1.5	6	5004	5204	5404	5604	4009	6009	7009	8009	T212B566J006(2)S				
6	56.0	B	T110B566K006A(3)	1.5	6	2246	2486	2726	2966	4010	6010	7010	8010	T212B566K006(2)S				
6	56.0	B	T110B566M006A(3)	1.5	6													
6	68.0	C	T110C686(1)006A(3)	3.0	6													
6	82.0	C	T110C826(1)006A(3)	3.0	6													
6	100.0	C	T110C107(1)006A(3)	3.0	6													
6	120.0	C	T110C127(1)006A(3)	3.0	6													
6	150.0	C	T110C157J006A(3)	4.5	6	5005	5205	5405	5605	4011	6011	7011	8011	T212C157J006(2)S				
6	150.0	C	T110C157K006A(3)	4.5	6	2247	2487	2727	2967	4012	6012	7012	8012	T212C157K006(2)S				
6	150.0	C	T110C157M006A(3)	4.5	6	2248	2488	2728	2968	4013	6013	7013	8013	T212C157M006(2)S				
6	180.0	C	T110C187J006A(3)	5.5	6	5006	5206	5406	5606	4014	6014	7014	8014	T212C187J006(2)S				
6	180.0	C	T110C187K006A(3)	5.5	6	2249	2489	2729	2969	4015	6015	7015	8015	T212C187K006(2)S				
6	180.0	C	T110C187M006A(3)	5.5	6													
6	220.0	D	T110D227(1)006A(3)	6.0	8													
6	270.0	D	T110D277J006A(3)	6.0	8	5007	5207	5407	5607	4016	6016	7016	8016	T212D277J006(2)S				
6	270.0	D	T110D277K006A(3)	6.0	8	2250	2490	2730	2970	4017	6017	7017	8017	T212D277K006(2)S				
6	270.0	D	T110D277M006A(3)	6.0	8													
6	330.0	D	T110D337J006A(3)	7.5	8	5008	5208	5408	5608	4018	6018	7018	8018	T212D337J006(2)S				
6	330.0	D	T110D337K006A(3)	7.5	8	2251	2491	2731	2971	4019	6019	7019	8019	T212D337K006(2)S				
6	330.0	D	T110D337M006A(3)	7.5	8	2252	2492	2732	2972	4020	6020	7020	8020	T212D337M006(2)S				
10	1.0	A	T110A105(1)010A(3)	0.3	3													
VDC	µF		(see below for part options)	µA @ 25°C Max/5 Minutes	120 Hz Maximum	M (1.0)	P (0.1)	R (0.01)	S (0.001)	G (1.0)	B (0.1)	C (0.01)	D (0.001)	Part Number				
Rated Voltage	Rated Cap	Case Size Code	KEMET Part Number	DC Leakage	DF % @ 25°C	MIL-PRF-39003 (CSR13) Capacitors												

(1) To complete KEMET Part Number, insert M for ±20%, K for ±10%, or J for 5%. Designates capacitance tolerance.
 (2) To complete KEMET Part Number (T212), insert Graded failure rate - A for Not Applicable, B for .1%/k hours, C for .01%/k hours, D for .001%/k hours, or G for 1%/k hours; or insert Exponential failure rate - M for 1%/k hours, P for .1%/k hours, R for .01%/k hours, or S for .001%/k hours. Designates Reliability Level.
 (3) To complete KEMET Part Number (T110), insert Lead Material designator - S for Standard or T for 100% Matte Tin. Designates Termination finish.
 Refer to Ordering Information for additional detail.

Table 1 – Ratings & Part Number Reference cont'd

Rated Voltage	Rated Cap	Case Size Code	KEMET Part Number	DC Leakage	DF % @ 25°C	MIL-PRF-39003 (CSR13) Capacitors										KEMET Equivalent Military Part Number		
						Dash Number Reference												
						Failure Rate Level (%/1,000 hours)												
						MIL-PRF-39003/1K				MIL-PRF-39003/1K								
						Exponential				Graded								
VDC	µF		(See below for part options)	µA @ 25°C Max/5 Minutes	120 Hz Maximum	M (1.0)	P (0.1)	R (0.01)	S (0.001)	G (1.0)	B (0.1)	C (0.01)	D (0.001)	Part Number				
10	1.2	A	T110A125(1)010A(3)	0.3	4													
10	1.5	A	T110A155(1)010A(3)	0.3	4													
10	1.8	A	T110A185(1)010A(3)	0.3	4													
10	2.2	A	T110A225(1)010A(3)	0.3	4													
10	2.7	A	T110A275(1)010A(3)	0.3	4													
10	3.3	A	T110A335(1)010A(3)	0.3	4													
10	3.9	A	T110A395J010A(3)	0.3	4	5009	5209	5409	5609	4021	6021	7021	8021	T212A395J010(2)S				
10	3.9	A	T110A395K010A(3)	0.3	4	2253	2493	2733	2973	4022	6022	7022	8022	T212A395K010(2)S				
10	3.9	A	T110A395M010A(3)	0.3	4													
10	4.7	A	T110A475J010A(3)	0.4	4	5010	5210	5410	5610	4023	6023	7023	8023	T212A475J010(2)S				
10	4.7	A	T110A475K010A(3)	0.4	4	2254	2494	2734	2974	4024	6024	7024	8024	T212A475K010(2)S				
10	4.7	A	T110A475M010A(3)	0.4	4	2255	2495	2735	2975	4025	6025	7025	8025	T212A475M010(2)S				
10	5.6	B	T110B565(1)010A(3)	0.4	4													
10	6.8	B	T110B685(1)010A(3)	1.0	6													
10	8.2	B	T110B825(1)010A(3)	1.0	6													
10	10.0	B	T110B106(1)010A(3)	1.0	6													
10	12.0	B	T110B126(1)010A(3)	1.0	6													
10	15.0	B	T110B156(1)010A(3)	1.0	6													
10	18.0	B	T110B186(1)010A(3)	1.0	6													
10	22.0	B	T110B226(1)010A(3)	2.0	6													
10	27.0	B	T110B276J010A(3)	2.0	6	5011	5211	5411	5611	4026	6026	7026	8026	T212B276J010(2)S				
10	27.0	B	T110B276K010(3)	2.0	6	2256	2496	2736	2976	4027	6027	7027	8027	T212B276K010(2)S				
10	27.0	B	T110B276M010A(3)	2.0	6													
10	33.0	B	T110B336J010A(3)	2.0	6	5012	5212	5412	5612	4028	6028	7028	8028	T212B336J010(2)S				
10	33.0	B	T110B336K010A(3)	2.0	6	2257	2497	2737	2977	4029	6029	7029	8029	T212B336K010(2)S				
10	33.0	B	T110B336M010A(3)	2.0	6	2258	2498	2738	2978	4030	6030	7030	8030	T212B336M010(2)S				
10	39.0	B	T110B396J010A(3)	2.0	6	5013	5213	5413	5613	4031	6031	7031	8031	T212B396J010(2)S				
10	39.0	B	T110B396K010A(3)	2.0	6	2259	2499	2739	2979	4032	6032	7032	8032	T212B396K010(2)S				
10	39.0	B	T110B396M010A(3)	2.0	6													
10	47.0	C	T110C476(1)010A(3)	3.0	6													
10	56.0	C	T110C566(1)010A(3)	3.0	6													
10	68.0	C	T110C686(1)010A(3)	3.0	6													
10	82.0	C	T110C826J010A(3)	3.0	6	5014	5214	5414	5614	4033	6033	7033	8033	T212C826J010(2)S				
10	82.0	C	T110C826K010A(3)	3.0	6	2260	2500	2740	2980	4034	6034	7034	8034	T212C826K010(2)S				
10	82.0	C	T110C826M010A(3)	3.0	6													
10	100.0	C	T110C107J010AS	5.0	6	5015	5215	5415	5615	4035	6035	7035	8035	T212C107J010(2)S				
10	100.0	C	T110C107K010AS	5.0	6	2261	2501	2741	2981	4036	6036	7036	8036	T212C107K010(2)S				
10	100.0	C	T110C107M010AS	5.0	6	2262	2502	2742	2982	4037	6037	7037	8037	T212C107M010(2)S				
10	120.0	C	T110C127J010AS	6.0	6	5016	5216	5416	5616	4038	6038	7038	8038	T212C127J010(2)S				
10	120.0	C	T110C127K010A(3)	6.0	6	2263	2503	2743	2983	4039	6039	7039	8039	T212C127K010(2)S				
10	120.0	C	T110C127M010A(3)	6.0	6													
10	150.0	D	T110D157(1)010A(3)	9.0	6													
10	180.0	D	T110D187J010A(3)	9.0	6	5017	5217	5417	5617	4040	6040	7040	8040	T212D187J010(2)S				
10	180.0	D	T110D187K010A(3)	9.0	6	2264	2504	2744	2984	4041	6041	7041	8041	T212D187K010(2)S				
VDC	µF		(see below for part options)	µA @ 25°C Max/5 Minimum	120 Hz Maximum	M (1.0)	P (0.1)	R (0.01)	S (0.001)	G (1.0)	B (0.1)	C (0.01)	D (0.001)	Part Number				
Rated Voltage	Rated Cap	Case Size Code	KEMET Part Number	DC Leakage	DF % @ 25°C	MIL-PRF-39003 (CSR13) Capacitors												

(1) To complete KEMET Part Number, insert M for ±20%, K for ±10%, or J for 5%. Designates capacitance tolerance.
 (2) To complete KEMET Part Number (T212), insert Graded failure rate - A for Not Applicable, B for .1%/k hours, C for .01%/k hours, D for .001%/k hours, or G for 1%/k hours; or insert Exponential failure rate - M for 1%/k hours, P for .1%/k hours, R for .01%/k hours, or S for .001%/k hours. Designates Reliability Level.
 (3) To complete KEMET Part Number (T110), insert Lead Material designator - S for Standard or T for 100% Matte Tin. Designates Termination finish.
 Refer to Ordering Information for additional detail.

Table 1 – Ratings & Part Number Reference cont'd

Rated Voltage	Rated Cap	Case Size Code	KEMET Part Number	DC Leakage	DF % @ 25°C	MIL-PRF-39003 (CSR13) Capacitors										KEMET Equivalent Military Part Number		
						Dash Number Reference												
						Failure Rate Level (%/1,000 hours)												
						MIL-PRF-39003/1K				MIL-PRF-39003/1K								
						Exponential				Graded								
VDC	µF		(See below for part options)	µA @ 25°C Max/5 Minutes	120 Hz Maximum	M (1.0)	P (0.1)	R (0.01)	S (0.001)	G (1.0)	B (0.1)	C (0.01)	D (0.001)	Part Number				
10	180.0	D	T110D187M010A(3)	9.0	6													
10	220.0	D	T110D227J010A(3)	10.0	8	5018	5218	5418	5618	4042	6042	7042	8042	T212D227J010(2)S				
10	220.0	D	T110D227K010A(3)	10.0	8	2265	2505	2745	2985	4043	6043	7043	8043	T212D227K010(2)S				
10	220.0	D	T110D227M010A(3)	10.0	8	2266	2506	2746	2986	4044	6044	7044	8044	T212D227M010(2)S				
15	0.33	A	T110A334(1)015A(3)	0.3	3													
15	0.39	A	T110A394(1)015A(3)	0.3	3													
15	0.47	A	T110A474(1)015A(3)	0.3	3													
15	0.56	A	T110A564(1)015A(3)	0.3	3													
15	0.68	A	T110A684(1)015A(3)	0.3	3													
15	1.0	A	T110A105(1)015A(3)	0.3	3													
15	1.2	A	T110A125(1)015A(3)	0.3	3													
15	1.5	A	T110A155(1)015A(3)	0.3	4													
15	1.8	A	T110A185(1)015A(3)	0.3	4													
15	2.2	A	T110A225(1)015A(3)	0.3	4													
15	2.7	A	T110A275J015A(3)	0.3	4	5019	5219	5419	5619	4045	6045	7045	8045	T212A275J015(2)S				
15	2.7	A	T110A275K015A(3)	0.3	4	2267	2507	2747	2987	4046	6046	7046	8046	T212A275K015(2)S				
15	2.7	A	T110A275M015A(3)	0.3	4													
15	3.3	A	T110A335J015A(3)	0.4	4	5020	5220	5420	5620	4047	6047	7047	8047	T212A335J015(2)S				
15	3.3	A	T110A335K015A(3)	0.4	4	2268	2508	2748	2988	4048	6048	7048	8048	T212A335K015(2)S				
15	3.3	A	T110A335M015A(3)	0.4	4	2269	2509	2749	2989	4049	6049	7049	8049	T212A335M015(2)S				
15	3.9	B	T110B395(1)015A(3)	0.4	4													
15	4.7	B	T110B475(1)015A(3)	0.7	4													
15	5.6	B	T110B565(1)015A(3)	0.7	4													
15	6.8	B	T110B685(1)015A(3)	0.7	6													
15	8.2	B	T110B825(1)015A(3)	0.7	6													
15	10.0	B	T110B106(1)015A(3)	1.0	6													
15	12.0	B	T110B126(1)015A(3)	1.0	6													
15	15.0	B	T110B156(1)015A(3)	2.0	6													
15	18.0	B	T110B186J015A(3)	2.0	6	5021	5221	5421	5621	4050	6050	7050	8050	T212B186J015(2)S				
15	18.0	B	T110B186K015A(3)	2.0	6	2270	2510	2750	2990	4051	6051	7051	8051	T212B186K015(2)S				
15	18.0	B	T110B186M015A(3)	2.0	6													
15	22.0	B	T110B226J015A(3)	2.0	6	5022	5222	5422	5622	4052	6052	7052	8052	T212B226J015(2)S				
15	22.0	B	T110B226K015A(3)	2.0	6	2271	2511	2751	2991	4053	6053	7053	8053	T212B226K015(2)S				
15	22.0	B	T110B226M015A(3)	2.0	6	2272	2512	2752	2992	4054	6054	7054	8054	T212B226M015(2)S				
15	27.0	C	T110C276(1)015A(3)	3.0	6													
15	33.0	C	T110C336(1)015A(3)	3.0	6													
15	39.0	C	T110C396(1)015A(3)	3.0	6													
15	47.0	C	T110C476(1)015A(3)	4.0	6													
15	56.0	C	T110C566J015A(3)	4.0	6	5023	5223	5423	5623	4055	6055	7055	8055	T212C566J015(2)S				
15	56.0	C	T110C566K015A(3)	4.0	6	2273	2513	2753	2993	4056	6056	7056	8056	T212C566K015(2)S				
15	56.0	C	T110C566M015A(3)	4.0	6													
15	68.0	C	T110C686J015A(3)	5.0	6	5024	5224	5424	5624	4057	6057	7057	8057	T212C686J015(2)S				
15	68.0	C	T110C686K015A(3)	5.0	6	2274	2514	2754	2994	4058	6058	7058	8058	T212C686K015(2)S				
15	68.0	C	T110C686M015A(3)	5.0	6	2275	2515	2755	2995	4059	6059	7059	8059	T212C686M015(2)S				
VDC	µF	Case Size Code	(see below for part options)	µA @ 25°C Max/5 Minimum	120 Hz Maximum	M (1.0)	P (0.1)	R (0.01)	S (0.001)	G (1.0)	B (0.1)	C (0.01)	D (0.001)	Part Number				
Rated Voltage	Rated Cap	Case Size Code	KEMET Part Number	DC Leakage	DF % @ 25°C	MIL-PRF-39003 (CSR13) Capacitors												

(1) To complete KEMET Part Number, insert M for ±20%, K for ±10%, or J for 5%. Designates capacitance tolerance.
 (2) To complete KEMET Part Number (T212), insert Graded failure rate - A for Not Applicable, B for .1%/k hours, C for .01%/k hours, D for .001%/k hours, or G for 1%/k hours; or insert Exponential failure rate - M for 1%/k hours, P for .1%/k hours, R for .01%/k hours, or S for .001%/k hours. Designates Reliability Level.
 (3) To complete KEMET Part Number (T110), insert Lead Material designator - S for Standard or T for 100% Matte Tin. Designates Termination finish.
 Refer to Ordering Information for additional detail.

Table 1 – Ratings & Part Number Reference cont'd

Rated Voltage	Rated Cap	Case Size Code	KEMET Part Number	DC Leakage	DF % @ 25°C	MIL-PRF-39003 (CSR13) Capacitors														
						Dash Number Reference														KEMET Equivalent Military
						Failure Rate Level (%/1,000 hours)														
						MIL-PRF-39003/1K							MIL-PRF-39003/1K							
						Exponential							Graded							
VDC	µF		(See below for part options)	µA @ 25°C Max/5 Minutes	120 Hz Maximum	M (1.0)	P (0.1)	R (0.01)	S (0.001)	G (1.0)	B (0.1)	C (0.01)	D (0.001)	Part Number						
15	82.0	D	T110D826(1)015A(3)	6.0	6															
15	100.0	D	T110D107(1)015A(3)	6.0	6															
15	120.0	D	T110D127J015A(3)	6.0	6	5025	5225	5425	5625	4060	6060	7060	8060	T212D127J015(2)S						
15	120.0	D	T110D127K015A(3)	6.0	6	2276	2516	2756	2996	4061	6061	7061	8061	T212D127K015(2)S						
15	120.0	D	T110D127M015A(3)	6.0	6															
15	150.0	D	T110D157J015A(3)	8.0	6	5026	5226	5426	5626	4062	6062	7062	8062	T212D157J015(2)S						
15	150.0	D	T110D157K015A(3)	8.0	6	2277	2517	2757	2997	4063	6063	7063	8063	T212D157K015(2)S						
15	150.0	D	T110D157M015A(3)	8.0	6	2278	2518	2758	2998	4064	6064	7064	8064	T212D157M015(2)S						
20	0.047	A	T110A473(1)020A(3)	0.3	3															
20	0.056	A	T110A563(1)020A(3)	0.3	3															
20	0.068	A	T110A683(1)020A(3)	0.3	3															
20	0.082	A	T110A823(1)020A(3)	0.3	3															
20	0.10	A	T110A104(1)020A(3)	0.3	3															
20	0.12	A	T110A124(1)020A(3)	0.3	3															
20	0.15	A	T110A154(1)020A(3)	0.3	3															
20	0.18	A	T110A184(1)020A(3)	0.3	3															
20	0.22	A	T110A224(1)020A(3)	0.3	3															
20	0.27	A	T110A274(1)020A(3)	0.3	3															
20	0.33	A	T110A334(1)020A(3)	0.3	3															
20	0.39	A	T110A394(1)020A(3)	0.3	3															
20	0.47	A	T110A474(1)020A(3)	0.3	3															
20	0.56	A	T110A564(1)020A(3)	0.3	3															
20	0.68	A	T110A684(1)020A(3)	0.3	3															
20	0.82	A	T110A824(1)020A(3)	0.3	3															
20	1.0	A	T110A105(1)020A(3)	0.3	3															
20	1.2	A	T110A125J020A(3)	0.3	4	5027	5227	5427	5627	4065	6065	7065	8065	T212A125J020(2)S						
20	1.2	A	T110A125K020A(3)	0.3	4	2279	2519	2759	2999	4066	6066	7066	8066	T212A125K020(2)S						
20	1.2	A	T110A125M020A(3)	0.3	4															
20	1.5	A	T110A155J020A(3)	0.3	4	5028	5228	5428	5628	4067	6067	7067	8067	T212A155J020(2)S						
20	1.5	A	T110A155K020A(3)	0.3	4	2280	2520	2760	3000	4068	6068	7068	8068	T212A155K020(2)S						
20	1.5	A	T110A155M020A(3)	0.3	4	2281	2521	2761	3001	4069	6069	7069	8069	T212A155M020(2)S						
20	1.8	A	T110A185J020A(3)	0.3	4	5029	5229	5429	5629	4070	6070	7070	8070	T212A185J020(2)S						
20	1.8	A	T110A185K020A(3)	0.3	4	2282	2522	2762	3002	4071	6071	7071	8071	T212A185K020(2)S						
20	1.8	A	T110A185M020A(3)	0.3	4															
20	2.2	A	T110A225J020A(3)	0.4	4	5010	5230	5430	5630	4072	6072	7072	8072	T212A225J020(2)S						
20	2.2	A	T110A225K020A(3)	0.4	4	2283	2523	2763	3003	4073	6073	7073	8073	T212A225K020(2)S						
20	2.2	A	T110A225M020A(3)	0.4	4	2284	2524	2764	3004	4074	6074	7074	8074	T212A225M020(2)S						
20	2.7	B	T110B275(1)020A(3)	0.5	4															
20	3.3	B	T110B335(1)020A(3)	1.0	4															
20	3.9	B	T110B395(1)020A(3)	1.0	4															
20	4.7	B	T110B475(1)020A(3)	1.0	4															
20	5.6	B	T110B565(1)020A(3)	1.0	4															
20	6.8	B	T110B685(1)020A(3)	1.0	4															
20	8.2	B	T110B825J020A(3)	1.0	6	5031	5231	5431	5631	4075	6075	7075	8075	T212B825J020(2)S						
VDC	µF		(see below for part options)	µA @ 25°C Max/5 Minutes	120 Hz Maximum	M (1.0)	P (0.1)	R (0.01)	S (0.001)	G (1.0)	B (0.1)	C (0.01)	D (0.001)	Part Number						
Rated Voltage	Rated Cap	Case Size Code	KEMET Part Number	DC Leakage	DF % @ 25°C	MIL-PRF-39003 (CSR13) Capacitors														

(1) To complete KEMET Part Number, insert M for ±20%, K for ±10%, or J for 5%. Designates capacitance tolerance.
 (2) To complete KEMET Part Number (T212), insert Graded failure rate - A for Not Applicable, B for .1%/k hours, C for .01%/k hours, D for .001%/k hours, or G for 1%/k hours; or insert Exponential failure rate - M for 1%/k hours, P for .1%/k hours, R for .01%/k hours, or S for .001%/k hours. Designates Reliability Level.
 (3) To complete KEMET Part Number (T110), insert Lead Material designator - S for Standard or T for 100% Matte Tin. Designates Termination finish.
 Refer to Ordering Information for additional detail.

Table 1 – Ratings & Part Number Reference cont'd

Rated Voltage	Rated Cap	Case Size Code	KEMET Part Number	DC Leakage	DF % @ 25°C	MIL-PRF-39003 (CSR13) Capacitors										KEMET Equivalent Military
						Dash Number Reference										
						Failure Rate Level (%/1,000 hours)										
						MIL-PRF-39003/1K					MIL-PRF-39003/1K					
						Exponential					Graded					
VDC	µF		(See below for part options)	µA @ 25°C Max/5 Minutes	120 Hz Maximum	M (1.0)	P (0.1)	R (0.01)	S (0.001)	G (1.0)	B (0.1)	C (0.01)	D (0.001)	Part Number		
20	8.2	B	T110B825K020A(3)	1.0	6	2285	2525	2765	3005	4076	6076	7076	8076	T212B825K020(2)S		
20	8.2	B	T110B825M020A(3)	1.0	6											
20	10.0	B	T110B106J020A(3)	1.0	6	5032	5232	5432	5632	4077	6077	7077	8077	T212B106J020(2)S		
20	10.0	B	T110B106K020A(3)	1.0	6	2286	2526	2766	3006	4078	6078	7078	8078	T212B106K020(2)S		
20	10.0	B	T110B106M020A(3)	1.0	6	2287	2527	2767	3007	4079	6079	7079	8079	T212B106M020(2)S		
20	12.0	B	T110B126J020A(3)	1.0	6	5033	5233	5433	5633	4080	6080	7080	8080	T212B126J020(2)S		
20	12.0	B	T110B126K020A(3)	1.0	6	2288	2528	2768	3008	4081	6081	7081	8081	T212B126K020(2)S		
20	12.0	B	T110B126M020A(3)	1.0	6											
20	15.0	B	T110B156J020A(3)	2.0	6	5034	5234	5434	5634	4082	6082	7082	8082	T212B156J020(2)S		
20	15.0	B	T110B156K020A(3)	2.0	6	2289	2529	2769	3009	4083	6083	7083	8083	T212B156K020(2)S		
20	15.0	B	T110B156M020A(3)	2.0	6	2290	2530	2770	3010	4084	6084	7084	8084	T212B156M020(2)S		
20	18.0	C	T110C186(1)020A(3)	2.0	6											
20	22.0	C	T110C226(1)020A(3)	2.5	6											
20	27.0	C	T110C276J020A(3)	2.5	6	5035	5235	5435	5635	4085	6085	7085	8085	T212C276J020(2)S		
20	27.0	C	T110C276K020A(3)	2.5	6	2991	2531	2771	3011	4086	6086	7086	8086	T212C276K020(2)S		
20	27.0	C	T110C276M020A(3)	2.5	6											
20	33.0	C	T110C336J020A(3)	3.0	6	5036	5236	5436	5636	4087	6087	7087	8087	T212C336J020(2)S		
20	33.0	C	T110C336K020A(3)	3.0	6	2292	2532	2772	3012	4088	6088	7088	8088	T212C336K020(2)S		
20	33.0	C	T110C336M020A(3)	3.0	6	2293	2533	2773	3013	4089	6089	7089	8089	T212C336M020(2)S		
20	39.0	C	T110C396J020A(3)	3.0	6	5037	5237	5437	5637	4090	6090	7090	8090	T212C396J020(2)S		
20	39.0	C	T110C396K020A(3)	3.0	6	2294	2534	2774	3014	4091	6091	7091	8091	T212C396K020(2)S		
20	39.0	C	T110C396M020A(3)	3.0	6											
20	47.0	C	T110C476J020A(3)	4.5	6	5038	5238	5438	5638	4092	6092	7092	8092	T212C476J020(2)S		
20	47.0	C	T110C476K020A(3)	4.5	6	2295	2535	2775	3015	4093	6093	7093	8093	T212C476K020(2)S		
20	47.0	C	T110C476M020A(3)	4.5	6	2296	2536	2776	3016	4094	6094	7094	8094	T212C476M020(2)S		
20	56.0	D	T110D566J020A(3)	5.5	6	5039	5239	5439	5639	4095	6095	7095	8095	T212D566J020(2)S		
20	56.0	D	T110D566K020A(3)	5.5	6	2297	2537	2777	3017	4096	6096	7096	8096	T212D566K020(2)S		
20	56.0	D	T110D566M020A(3)	5.5	6											
20	68.0	D	T110D686J020A(3)	6.0	6	5040	5240	5440	5640	4097	6097	7097	8097	T212D686J020(2)S		
20	68.0	D	T110D686K020A(3)	6.0	6	2298	2538	2778	3018	4098	6098	7098	8098	T212D686K020(2)S		
20	68.0	D	T110D686M020A(3)	6.0	6	2299	2539	2779	3019	4099	6099	7099	8099	T212D686M020(2)S		
20	82.0	D	T110D826J020A(3)	6.0	6	5041	5241	5441	5641	4100	6100	7100	8100	T212D826J020(2)S		
20	82.0	D	T110D826K020A(3)	6.0	6	2300	2540	2780	3020	4101	6101	7101	8101	T212D826K020(2)S		
20	82.0	D	T110D826M020A(3)	6.0	6											
20	100.0	D	T110D107J020A(3)	10.0	6	5042	5242	5442	5642	4102	6102	7102	8102	T212D107J020(2)S		
20	100.0	D	T110D107K020A(3)	10.0	6	2301	2541	2781	3021	4103	6103	7103	8103	T212D107K020(2)S		
20	100.0	D	T110D107M020A(3)	10.0	6	2302	2542	2782	3022	4104	6104	7104	8104	T212D107M020(2)S		
35	0.0047	A	T110A472(1)035A(3)	0.1	3											
35	0.0056	A	T110A562(1)035A(3)	0.1	3											
35	0.0068	A	T110A682(1)035A(3)	0.1	3											
35	0.0082	A	T110A822(1)035A(3)	0.1	3											
35	0.01	A	T110A103(1)035A(3)	0.1	3											
35	0.012	A	T110A123(1)035A(3)	0.1	3											
35	0.015	A	T110A153(1)035A(3)	0.1	3											
VDC	µF		(see below for part options)	µA @ 25°C Max/5 Minimum	120 Hz Maximum	M (1.0)	P (0.1)	R (0.01)	S (0.001)	G (1.0)	B (0.1)	C (0.01)	D (0.001)	Part Number		
Rated Voltage	Rated Cap	Case Size Code	KEMET Part Number	DC Leakage	DF % @ 25°C	MIL-PRF-39003 (CSR13) Capacitors										

(1) To complete KEMET Part Number, insert M for ±20%, K for ±10%, or J for 5%. Designates capacitance tolerance.
 (2) To complete KEMET Part Number (T212), insert Graded failure rate - A for Not Applicable, B for .1%/k hours, C for .01%/k hours, D for .001%/k hours, or G for 1%/k hours; or insert Exponential failure rate - M for 1%/k hours, P for .1%/k hours, R for .01%/k hours, or S for .001%/k hours. Designates Reliability Level.
 (3) To complete KEMET Part Number (T110), insert Lead Material designator - S for Standard or T for 100% Matte Tin. Designates Termination finish.
 Refer to Ordering Information for additional detail.

Table 1 – Ratings & Part Number Reference cont'd

Rated Voltage	Rated Cap	Case Size Code	KEMET Part Number	DC Leakage	DF % @ 25°C	MIL-PRF-39003 (CSR13) Capacitors														
						Dash Number Reference														KEMET Equivalent Military
						Failure Rate Level (%/1,000 hours)														
						MIL-PRF-39003/1K							MIL-PRF-39003/1K							
						Exponential							Graded							
VDC	µF		(See below for part options)	µA @ 25°C Max/5 Minutes	120 Hz Maximum	M (1.0)	P (0.1)	R (0.01)	S (0.001)	G (1.0)	B (0.1)	C (0.01)	D (0.001)	Part Number						
35	0.018	A	T110A183(1)035A(3)	0.1	3															
35	0.022	A	T110A223(1)035A(3)	0.1	3															
35	0.027	A	T110A273(1)035A(3)	0.1	3															
35	0.033	A	T110A333(1)035A(3)	0.1	3															
35	0.039	A	T110A393(1)035A(3)	0.1	3															
35	0.047	A	T110A473(1)035A(3)	0.1	3															
35	0.056	A	T110A563(1)035A(3)	0.1	3															
35	0.068	A	T110A683(1)035A(3)	0.1	3															
35	0.082	A	T110A823(1)035A(3)	0.1	3															
35	0.1	A	T110A104(1)035A(3)	0.5	3															
35	0.12	A	T110A124(1)035A(3)	0.5	3															
35	0.15	A	T110A154(1)035A(3)	0.5	3															
35	0.18	A	T110A184(1)035A(3)	0.5	3															
35	0.22	A	T110A224(1)035A(3)	0.5	3															
35	0.27	A	T110A274(1)035A(3)	0.5	3															
35	0.33	A	T110A334(1)035A(3)	0.5	3															
35	0.39	A	T110A394(1)035A(3)	0.5	3															
35	0.47	A	T110A474(1)035A(3)	0.5	3															
35	0.56	A	T110A564(1)035A(3)	0.5	3															
35	0.68	A	T110A684(1)035A(3)	0.5	3															
35	0.82	A	T110A824(1)035A(3)	0.5	3															
35	1.0	A	T110A105(1)035A(3)	0.5	6															
35	1.2	B	T110B125(1)035A(3)	0.5	4															
35	1.5	B	T110B155(1)035A(3)	0.5	4															
35	1.8	B	T110B185(1)035A(3)	0.5	4															
35	2.2	B	T110B225(1)035A(3)	1.0	4															
35	2.7	B	T110B275(1)035A(3)	1.0	4															
35	3.3	B	T110B335(1)035A(3)	1.0	4															
35	3.9	B	T110B395(1)035A(3)	1.0	4															
35	4.7	B	T110B475(1)035A(3)	1.0	4															
35	5.6	B	T110B565J035A(3)	1.0	4	5043	5243	5443	5643	4105	6105	7105	8105	T212B565J035(2)S						
35	5.6	B	T110B565K035A(3)	1.0	4	2303	2543	2783	3023	4106	6106	7106	8106	T212B565K035(2)S						
35	5.6	B	T110B565M035A(3)	1.0	4															
35	6.8	B	T110B685J035A(3)	1.5	4	5044	5244	5444	5644	4107	6107	7107	8107	T212B685J035(2)S						
35	6.8	B	T110B685K035A(3)	1.5	4	2304	2544	2784	3024	4108	6108	7108	8108	T212B685K035(2)S						
35	6.8	B	T110B685M035A(3)	1.5	4	2305	2545	2785	3025	4109	6109	7109	8109	T212B685M035(2)S						
35	8.2	C	T110C825(1)035A(3)	3.0	4															
35	10.0	C	T110C106(1)035A(3)	3.0	4															
35	12.0	C	T110C126(1)035A(3)	3.0	4															
35	15.0	C	T110C156(1)035A(3)	3.0	4															
35	18.0	C	T110C186(1)035A(3)	3.0	4															
35	22.0	C	T110C226J035A(3)	4.0	4	5045	5245	5445	5645	4110	6110	7110	8110	T212C226J035(2)S						
35	22.0	C	T110C226K035A(3)	4.0	4	2306	2546	2786	3026	4111	6111	7111	8111	T212C226K035(2)S						
35	22.0	C	T110C226M035A(3)	4.0	4	2307	2547	2787	3027	4112	6112	7112	8112	T212C226M035(2)S						
VDC	µF		(see below for part options)	µA @ 25°C Max/5 Minutes	120 Hz Maximum	M (1.0)	P (0.1)	R (0.01)	S (0.001)	G (1.0)	B (0.1)	C (0.01)	D (0.001)	Part Number						
Rated Voltage	Rated Cap	Case Size Code	KEMET Part Number	DC Leakage	DF % @ 25°C	MIL-PRF-39003 (CSR13) Capacitors														

(1) To complete KEMET Part Number, insert M for ±20%, K for ±10%, or J for 5%. Designates capacitance tolerance.
 (2) To complete KEMET Part Number (T212), insert Graded failure rate - A for Not Applicable, B for .1%/k hours, C for .01%/k hours, D for .001%/k hours, or G for 1%/k hours; or insert Exponential failure rate - M for 1%/k hours, P for .1%/k hours, R for .01%/k hours, or S for .001%/k hours. Designates Reliability Level.
 (3) To complete KEMET Part Number (T110), insert Lead Material designator - S for Standard or T for 100% Matte Tin. Designates Termination finish.
 Refer to Ordering Information for additional detail.

Table 1 – Ratings & Part Number Reference cont'd

Rated Voltage	Rated Cap	Case Size Code	KEMET Part Number	DC Leakage	DF % @ 25°C	MIL-PRF-39003 (CSR13) Capacitors										KEMET Equivalent Military
						Dash Number Reference								Part Number		
						Failure Rate Level (%/1,000 hours)										
						MIL-PRF-39003/1K				MIL-PRF-39003/1K						
						Exponential				Graded						
VDC	µF		(See below for part options)	µA @ 25°C Max/5 Minutes	120 Hz Maximum	M (1.0)	P (0.1)	R (0.01)	S (0.001)	G (1.0)	B (0.1)	C (0.01)	D (0.001)			
35	27.0	D	T110D276J035A(3)	4.5	4	5046	5246	5446	5646	4113	6113	7113	8113	T212D276J035(2)S		
35	27.0	D	T110D276K035A(3)	4.5	4	2308	2548	2788	3028	4114	6114	7114	8114	T212D276K035(2)S		
35	27.0	D	T110D276M035A(3)	4.5	4											
35	33.0	D	T110D336J035A(3)	5.5	4	5047	5247	5447	5647	4115	6115	7115	8115	T212D336J035(2)S		
35	33.0	D	T110D336K035A(3)	5.5	4	2309	2549	2789	3029	4116	6116	7116	8116	T212D336K035(2)S		
35	33.0	D	T110D336M035A(3)	5.5	4	2310	2550	2790	3030	4117	6117	7117	8117	T212D336M035(2)S		
35	39.0	D	T110D396J035A(3)	6.0	4	5048	5248	5448	5648	4118	6118	7118	8118	T212D396J035(2)S		
35	39.0	D	T110D396K035A(3)	6.0	4	2311	2551	2791	3031	4119	6119	7119	8119	T212D396K035(2)S		
35	39.0	D	T110D396M035A(3)	6.0	4											
35	47.0	D	T110D476J035A(3)	8.0	4	5049	5249	5449	5649	4120	6120	7120	8120	T212D476J035(2)S		
35	47.0	D	T110D476K035A(3)	8.0	4	2312	2552	2792	3032	4121	6121	7121	8121	T212D476K035(2)S		
35	47.0	D	T110D476M035A(3)	8.0	4	2313	2553	2793	3033	4122	6122	7122	8122	T212D476M035(2)S		
50	0.0047	A	T110A472J050A(3)	0.1	2	5050	5250	5450	5650	4123	6123	7123	8123	T212A472J050(2)S		
50	0.0047	A	T110A472K050A(3)	0.1	2	2314	2554	2794	3034	4124	6124	7124	8124	T212A472K050(2)S		
50	0.0047	A	T110A472M050A(3)	0.1	2	2315	2555	2795	3035	4125	6125	7125	8125	T212A472M050(2)S		
50	0.0056	A	T110A562J050A(3)	0.1	2	5051	5251	5451	5651	4126	6126	7126	8126	T212A562J050(2)S		
50	0.0056	A	T110A562K050A(3)	0.1	2	2316	2556	2796	3036	4127	6127	7127	8127	T212A562K050(2)S		
50	0.0056	A	T110A562M050A(3)	0.1	2											
50	0.0068	A	T110A682J050A(3)	0.1	2	5052	5252	5452	5652	4128	6128	7128	8128	T212A682J050(2)S		
50	0.0068	A	T110A682K050A(3)	0.1	2	2317	2557	2797	3037	4129	6129	7129	8129	T212A682K050(2)S		
50	0.0068	A	T110A682M050A(3)	0.1	2	2318	2558	2798	3038	4130	6130	7130	8130	T212A682M050(2)S		
50	0.0082	A	T110A822J050A(3)	0.1	2	5053	5253	5453	5653	4131	6131	7131	8131	T212A822J050(2)S		
50	0.0082	A	T110A822K050A(3)	0.1	2	2319	2559	2799	3039	4132	6132	7132	8132	T212A822K050(2)S		
50	0.0082	A	T110A822M050A(3)	0.1	2											
50	0.01	A	T110A103J050A(3)	0.1	2	5054	5254	5454	5654	4133	6133	7133	8133	T212A103J050(2)S		
50	0.01	A	T110A103K050A(3)	0.1	2	2320	2560	2800	3040	4134	6134	7134	8134	T212A103K050(2)S		
50	0.01	A	T110A103M050A(3)	0.1	2	2321	2561	2801	3041	4135	6135	7135	8135	T212A103M050(2)S		
50	0.012	A	T110A123J050A(3)	0.1	2	5055	5255	5455	5655	4136	6136	7136	8136	T212A123J050(2)S		
50	0.012	A	T110A123K050A(3)	0.1	2	2322	2562	2802	3042	4137	6137	7137	8137	T212A123K050(2)S		
50	0.012	A	T110A123M050A(3)	0.1	2											
50	0.015	A	T110A153J050A(3)	0.1	2	5056	5256	5456	5656	4138	6138	7138	8138	T212A153J050(2)S		
50	0.015	A	T110A153K050A(3)	0.1	2	2323	2563	2803	3043	4139	6139	7139	8139	T212A153K050(2)S		
50	0.015	A	T110A153M050A(3)	0.1	2	2324	2564	2804	3044	4140	6140	7140	8140	T212A153M050(2)S		
50	0.018	A	T110A183J050A(3)	0.1	2	5057	5257	5457	5657	4141	6141	7141	8141	T212A183J050(2)S		
50	0.018	A	T110A183K050A(3)	0.1	2	2325	2565	2805	3045	4142	6142	7142	8142	T212A183K050(2)S		
50	0.018	A	T110A183M050A(3)	0.1	2											
50	0.022	A	T110A223J050A(3)	0.1	2	5058	5258	5458	5658	4143	6143	7143	8143	T212A223J050(2)S		
50	0.022	A	T110A223K050A(3)	0.1	2	2326	2566	2806	3046	4144	6144	7144	8144	T212A223K050(2)S		
50	0.022	A	T110A223M050A(3)	0.1	2	2327	2567	2807	3047	4145	6145	7145	8145	T212A223M050(2)S		
50	0.027	A	T110A273J050A(3)	0.1	2	5059	5259	5459	5659	4146	6146	7146	8146	T212A273J050(2)S		
50	0.027	A	T110A273K050A(3)	0.1	2	2328	2568	2808	3048	4147	6147	7147	8147	T212A273K050(2)S		
50	0.027	A	T110A273M050A(3)	0.1	2											
50	0.033	A	T110A333J050A(3)	0.1	2	5060	5260	5460	5660	4148	6148	7148	8148	T212A333J050(2)S		
50	0.033	A	T110A333K050A(3)	0.1	2	2329	2569	2809	3049	4149	6149	7149	8149	T212A333K050(2)S		
50	0.033	A	T110A333M050A(3)	0.1	2											
VDC	µF		(see below for part options)	µA @ 25°C Max/5 Minimum	120 Hz Maximum	M (1.0)	P (0.1)	R (0.01)	S (0.001)	G (1.0)	B (0.1)	C (0.01)	D (0.001)	Part Number		
Rated Voltage	Rated Cap	Case Size Code	KEMET Part Number	DC Leakage	DF % @ 25°C	MIL-PRF-39003 (CSR13) Capacitors										

(1) To complete KEMET Part Number, insert M for ±20%, K for ±10%, or J for 5%. Designates capacitance tolerance.
 (2) To complete KEMET Part Number (T212), insert Graded failure rate - A for Not Applicable, B for .1%/k hours, C for .01%/k hours, D for .001%/k hours, or G for 1%/k hours; or insert Exponential failure rate - M for 1%/k hours, P for .1%/k hours, R for .01%/k hours, or S for .001%/k hours. Designates Reliability Level.
 (3) To complete KEMET Part Number (T110), insert Lead Material designator - S for Standard or T for 100% Matte Tin. Designates Termination finish.
 Refer to Ordering Information for additional detail.

Table 1 – Ratings & Part Number Reference cont'd

Rated Voltage	Rated Cap	Case Size Code	KEMET Part Number	DC Leakage	DF % @ 25°C	MIL-PRF-39003 (CSR13) Capacitors										KEMET Equivalent Military
						Dash Number Reference										
						Failure Rate Level (%/1,000 hours)										
						MIL-PRF-39003/1K					MIL-PRF-39003/1K					
						Exponential					Graded					
VDC	µF		(See below for part options)	µA @ 25°C Max/5 Minutes	120 Hz Maximum	M (1.0)	P (0.1)	R (0.01)	S (0.001)	G (1.0)	B (0.1)	C (0.01)	D (0.001)	Part Number		
50	0.033	A	T110A333M050A(3)	0.1	2	2330	2570	2810	3050	4150	6150	7150	8150	T212A333M050(2)S		
50	0.039	A	T110A393J050A(3)	0.1	2	5061	5261	5461	5661	4151	6151	7151	8151	T212A393J050(2)S		
50	0.039	A	T110A393K050A(3)	0.1	2	2331	2571	2811	3051	4152	6152	7152	8152	T212A393K050(2)S		
50	0.039	A	T110A393M050A(3)	0.1	2											
50	0.047	A	T110A473J050A(3)	0.1	2	5062	5262	5462	5662	4153	6153	7153	8153	T212A473J050(2)S		
50	0.047	A	T110A473K050A(3)	0.1	2	2332	2572	2812	3052	4154	6154	7154	8154	T212A473K050(2)S		
50	0.047	A	T110A473M050A(3)	0.1	2	2333	2573	2813	3053	4155	6155	7155	8155	T212A473M050(2)S		
50	0.056	A	T110A563J050A(3)	0.1	2	5063	5263	5463	5663	4156	6156	7156	8156	T212A563J050(2)S		
50	0.056	A	T110A563K050A(3)	0.1	2	2334	2574	2814	3054	4157	6157	7157	8157	T212A563K050(2)S		
50	0.056	A	T110A563M050A(3)	0.1	2											
50	0.068	A	T110A683J050A(3)	0.1	2	5064	5264	5464	5664	4158	6158	7158	8158	T212A683J050(2)S		
50	0.068	A	T110A683K050A(3)	0.1	2	2335	2575	2815	3055	4159	6159	7159	8159	T212A683K050(2)S		
50	0.068	A	T110A683M050A(3)	0.1	2	2336	2576	2816	3056	4160	6160	7160	8160	T212A683M050(2)S		
50	0.082	A	T110A823J050A(3)	0.1	2	5065	5265	5465	5665	4161	6161	7161	8161	T212A823J050(2)S		
50	0.082	A	T110A823K050A(3)	0.1	2	2337	2577	2817	3057	4162	6162	7162	8162	T212A823K050(2)S		
50	0.082	A	T110A823M050A(3)	0.1	2											
50	0.1	A	T110A104J050A(3)	0.3	2	5066	5266	5466	5666	4163	6163	7163	8163	T212A104J050(2)S		
50	0.1	A	T110A104K050A(3)	0.3	2	2338	2578	2818	3058	4164	6164	7164	8164	T212A104K050(2)S		
50	0.1	A	T110A104M050A(3)	0.3	2	2339	2579	2819	3059	4165	6165	7165	8165	T212A104M050(2)S		
50	0.12	A	T110A124J050A(3)	0.3	2	5067	5267	5467	5667	4166	6166	7166	8166	T212A124J050(2)S		
50	0.12	A	T110A124K050A(3)	0.3	2	2340	2580	2820	3060	4167	6167	7167	8167	T212A124K050(2)S		
50	0.12	A	T110A124M050A(3)	0.3	2											
50	0.15	A	T110A154J050A(3)	0.3	2	5068	5268	5468	5668	4168	6168	7168	8168	T212A154J050(2)S		
50	0.15	A	T110A154K050A(3)	0.3	2	2341	2581	2821	3061	4169	6169	7169	8169	T212A154K050(2)S		
50	0.15	A	T110A154M050A(3)	0.3	2	2342	2582	2822	3062	4170	6170	7170	8170	T212A154M050(2)S		
50	0.18	A	T110A184J050A(3)	0.3	2	5069	5269	5469	5669	4171	6171	7171	8171	T212A184J050(2)S		
50	0.18	A	T110A184K050A(3)	0.3	2	2343	2583	2823	3063	4172	6172	7172	8172	T212A184K050(2)S		
50	0.18	A	T110A184M050A(3)	0.3	2											
50	0.22	A	T110A224J050A(3)	0.3	2	5070	5270	5470	5670	4173	6173	7173	8173	T212A224J050(2)S		
50	0.22	A	T110A224K050A(3)	0.3	2	2344	2584	2824	3064	4174	6174	7174	8174	T212A224K050(2)S		
50	0.22	A	T110A224M050A(3)	0.3	2	2345	2585	2825	3065	4175	6175	7175	8175	T212A224M050(2)S		
50	0.27	A	T110A274J050A(3)	0.3	2	5071	5271	5471	5671	4176	6176	7176	8176	T212A274J050(2)S		
50	0.27	A	T110A274K050A(3)	0.3	2	2346	2586	2826	3066	4177	6177	7177	8177	T212A274K050(2)S		
50	0.27	A	T110A274M050A(3)	0.3	2											
50	0.33	A	T110A334J050A(3)	0.3	2	5072	5272	5472	5672	4178	6178	7178	8178	T212A334J050(2)S		
50	0.33	A	T110A334K050A(3)	0.3	2	2347	2587	2827	3067	4179	6179	7179	8179	T212A334K050(2)S		
50	0.33	A	T110A334M050A(3)	0.3	2	2348	2588	2828	3068	4180	6180	7180	8180	T212A334M050(2)S		
50	0.39	A	T110A394J050A(3)	0.3	2	5073	5273	5473	5673	4181	6181	7181	8181	T212A394J050(2)S		
50	0.39	A	T110A394K050A(3)	0.3	2	2349	2589	2829	3069	4182	6182	7182	8182	T212A394K050(2)S		
50	0.39	A	T110A394M050A(3)	0.3	2											
50	0.47	A	T110A474J050A(3)	0.3	2	5074	5274	5474	5674	4183	6183	7183	8183	T212A474J050(2)S		
50	0.47	A	T110A474K050A(3)	0.3	2	2350	2590	2830	3070	4184	6184	7184	8184	T212A474K050(2)S		
50	0.47	A	T110A474M050A(3)	0.3	2	2351	2591	2831	3071	4185	6185	7185	8185	T212A474M050(2)S		
50	0.56	A	T110A564J050A(3)	0.3	2	5075	5275	5475	5675	4186	6186	7186	8186	T212A564J050(2)S		
50	0.56	A	T110A564M050A(3)	0.3	2											
VDC	µF		(see below for part options)	µA @ 25°C Max/5 Minimum	120 Hz Maximum	M (1.0)	P (0.1)	R (0.01)	S (0.001)	G (1.0)	B (0.1)	C (0.01)	D (0.001)	Part Number		
Rated Voltage	Rated Cap	Case Size Code	KEMET Part Number	DC Leakage	DF % @ 25°C	MIL-PRF-39003 (CSR13) Capacitors										

(1) To complete KEMET Part Number, insert M for ±20%, K for ±10%, or J for 5%. Designates capacitance tolerance.
 (2) To complete KEMET Part Number (T212), insert Graded failure rate - A for Not Applicable, B for .1%/k hours, C for .01%/k hours, D for .001%/k hours, or G for 1%/k hours; or insert Exponential failure rate - M for 1%/k hours, P for .1%/k hours, R for .01%/k hours, or S for .001%/k hours. Designates Reliability Level.
 (3) To complete KEMET Part Number (T110), insert Lead Material designator - S for Standard or T for 100% Matte Tin. Designates Termination finish.
 Refer to Ordering Information for additional detail.

Table 1 – Ratings & Part Number Reference cont'd

Rated Voltage	Rated Cap	Case Size Code	KEMET Part Number	DC Leakage	DF % @ 25°C	MIL-PRF-39003 (CSR13) Capacitors										KEMET Equivalent Military Part Number
						Dash Number Reference										
						Failure Rate Level (%/1,000 hours)										
						MIL-PRF-39003/1K					MIL-PRF-39003/1K					
						Exponential					Graded					
VDC	µF		(See below for part options)	µA @ 25°C Max/5 Minutes	120 Hz Maximum	M (1.0)	P (0.1)	R (0.01)	S (0.001)	G (1.0)	B (0.1)	C (0.01)	D (0.001)	Part Number		
50	0.56	A	T110A564K050A(3)	0.3	2	2352	2592	2832	3072	4187	6187	7187	8187	T212A564K050(2)S		
50	0.56	A	T110A564M050A(3)	0.3	2											
50	0.68	A	T110A684J050A(3)	0.3	2											
50	0.68	A	T110A684K050A(3)	0.3	2	2353	2593	2833	3073	4189	6189	7189	8189	T212A684K050(2)S		
50	0.68	A	T110A684M050A(3)	0.3	2	2354	2594	2834	3074	4190	6190	7190	8190	T212A684M050(2)S		
50	0.82	A	T110A824J050A(3)	0.3	2	5077	5277	5477	5677	4191	6191	7191	8191	T212A824J050(2)S		
50	0.82	A	T110A824K050A(3)	0.3	2	2355	2595	2835	3075	4192	6192	7192	8192	T212A824K050(2)S		
50	0.82	A	T110A824M050A(3)	0.3	2											
50	1.0	A	T110A105J050A(3)	0.4	2	5078	5278	5478	5678	4193	6193	7193	8193	T212A105J050(2)S		
50	1.0	A	T110A105K050A(3)	0.4	2	2356	2596	2836	3076	4194	6194	7194	8194	T212A105K050(2)S		
50	1.0	A	T110A105M050A(3)	0.4	2	2357	2597	2837	3077	4195	6195	7195	8195	T212A105M050(2)S		
50	1.2	B	T110B125J050A(3)	0.4	4	5079	5279	5479	5679	4196	6196	7196	8196	T212B125J050(2)S		
50	1.2	B	T110B125K050A(3)	0.4	4	2358	2598	2838	3078	4197	6197	7197	8197	T212B125K050(2)S		
50	1.2	B	T110B125M050A(3)	0.4	4											
50	1.5	B	T110B155J050A(3)	0.5	4	5080	5280	5480	5680	4198	6198	7198	8198	T212B155J050(2)S		
50	1.5	B	T110B155K050A(3)	0.5	4	2359	2599	2839	3079	4199	6199	7199	8199	T212B155K050(2)S		
50	1.5	B	T110B155M050A(3)	0.5	4	2360	2600	2840	3080	4200	6200	7200	8200	T212B155M050(2)S		
50	1.8	B	T110B185J050A(3)	0.5	4	5081	5281	5481	5681	4201	6201	7201	8201	T212B185J050(2)S		
50	1.8	B	T110B185K050A(3)	0.5	4	2361	2601	2841	3081	4202	6202	7202	8202	T212B185K050(2)S		
50	1.8	B	T110B185M050A(3)	0.5	4											
50	2.2	B	T110B225J050A(3)	0.8	4	5082	5282	5482	5682	4203	6203	7203	8203	T212B225J050(2)S		
50	2.2	B	T110B225K050A(3)	0.8	4	2362	2602	2842	3082	4204	6204	7204	8204	T212B225K050(2)S		
50	2.2	B	T110B225M050A(3)	0.8	4	2363	2603	2843	3083	4205	6205	7205	8205	T212B225M050(2)S		
50	2.7	B	T110B275J050A(3)	0.8	4	5083	5283	5483	5683	4206	6206	7206	8206	T212B275J050(2)S		
50	2.7	B	T110B275K050A(3)	0.8	4	2364	2604	2844	3084	4207	6207	7207	8207	T212B275K050(2)S		
50	2.7	B	T110B275M050A(3)	0.8	4											
50	3.3	B	T110B335J050A(3)	1.2	4	5084	5284	5484	5684	4208	6208	7208	8208	T212B335J050(2)S		
50	3.3	B	T110B335K050A(3)	1.2	4	2365	2605	2845	3085	4209	6209	7209	8209	T212B335K050(2)S		
50	3.3	B	T110B335M050A(3)	1.2	4	2366	2606	2846	3086	4210	6210	7210	8210	T212B335M050(2)S		
50	3.9	B	T110B395J050A(3)	1.5	4	5085	5285	5485	5685	4211	6211	7211	8211	T212B395J050(2)S		
50	3.9	B	T110B395K050A(3)	1.5	4	2367	2607	2847	3087	4212	6212	7212	8212	T212B395K050(2)S		
50	3.9	B	T110B395M050A(3)	1.5	4											
50	4.7	B	T110B475J050A(3)	1.7	4	5086	5286	5486	5686	4213	6213	7213	8213	T212B475J050(2)S		
50	4.7	B	T110B475K050A(3)	1.7	4	2368	2608	2848	3088	4214	6214	7214	8214	T212B475K050(2)S		
50	4.7	B	T110B475M050A(3)	1.7	4	2369	2609	2849	3089	4215	6215	7215	8215	T212B475M050(2)S		
50	5.6	C	T110C565J050A(3)	2.2	4	5087	5287	5487	5687	4216	6216	7216	8216	T212C565J050(2)S		
50	5.6	C	T110C565K050A(3)	2.2	4	2370	2610	2850	3090	4217	6217	7217	8217	T212C565K050(2)S		
50	5.6	C	T110C565M050A(3)	2.2	4											
50	6.8	C	T110C685J050A(3)	2.2	4	5088	5288	5488	5688	4218	6218	7218	8218	T212C685J050(2)S		
50	6.8	C	T110C685K050A(3)	2.2	4	2371	2611	2851	3091	4219	6219	7219	8219	T212C685K050(2)S		
50	6.8	C	T110C685M050A(3)	2.2	4	2372	2612	2852	3092	4220	6220	7220	8220	T212C685M050(2)S		
50	8.2	C	T110C825J050A(3)	2.5	4	5089	5289	5489	5689	4221	6221	7221	8221	T212C825J050(2)S		
50	8.2	C	T110C825K050A(3)	2.5	4	2373	2613	2853	3093	4222	6222	7222	8222	T212C825K050(2)S		
50	8.2	C	T110C825M050A(3)	2.5	4											
VDC	µF		(see below for part options)	µA @ 25°C Max/5 Minimum	120 Hz Maximum	M (1.0)	P (0.1)	R (0.01)	S (0.001)	G (1.0)	B (0.1)	C (0.01)	D (0.001)	Part Number		
Rated Voltage	Rated Cap	Case Size Code	KEMET Part Number	DC Leakage	DF % @ 25°C	MIL-PRF-39003 (CSR13) Capacitors										

(1) To complete KEMET Part Number, insert M for ±20%, K for ±10%, or J for 5%. Designates capacitance tolerance.

(2) To complete KEMET Part Number (T212), insert Graded failure rate - A for Not Applicable, B for .1%/k hours, C for .01%/k hours, D for .001%/k hours, or G for 1%/k hours; or insert Exponential failure rate - M for 1%/k hours, P for .1%/k hours, R for .01%/k hours, or S for .001%/k hours. Designates Reliability Level.

(3) To complete KEMET Part Number (T110), insert Lead Material designator - S for Standard or T for 100% Matte Tin. Designates Termination finish.

Refer to Ordering Information for additional detail.

Table 1 – Ratings & Part Number Reference cont'd

Rated Voltage	Rated Cap	Case Size Code	KEMET Part Number	DC Leakage	DF % @ 25°C	MIL-PRF-39003 (CSR13) Capacitors										KEMET Equivalent Military Part Number
						Dash Number Reference										
						Failure Rate Level (%/1,000 hours)										
						MIL-PRF-39003/1K					MIL-PRF-39003/1K					
						Exponential					Graded					
VDC	µF		(See below for part options)	µA @ 25°C Max/5 Minutes	120 Hz Maximum	M (1.0)	P (0.1)	R (0.01)	S (0.001)	G (1.0)	B (0.1)	C (0.01)	D (0.001)	Part Number		
50	10.0	C	T110C106J050A(3)	2.5	4	5090	5290	5490	5690	4223	6223	7223	8223	T212C106J050(2)S		
50	10.0	C	T110C106K050A(3)	2.5	4	2374	2614	2854	3094	4224	6224	7224	8224	T212C106K050(2)S		
50	10.0	C	T110C106M050A(3)	2.5	4	2375	2615	2855	3095	4225	6225	7225	8225	T212C106M050(2)S		
50	12.0	C	T110C126J050A(3)	3.0	4	5091	5291	5491	5691	4226	6226	7226	8226	T212C126J050(2)S		
50	12.0	C	T110C126K050A(3)	3.0	4	2376	2616	2856	3096	4227	6227	7227	8227	T212C126K050(2)S		
50	12.0	C	T110C126M050A(3)	3.0	4											
50	15.0	C	T110C156J050A(3)	4.0	4	5092	5292	5492	5692	4228	6228	7228	8228	T212C156J050(2)S		
50	15.0	C	T110C156K050A(3)	4.0	4	2377	2617	2857	3097	4229	6229	7229	8229	T212C156K050(2)S		
50	15.0	C	T110C156M050A(3)	4.0	4	2378	2618	2858	3098	4230	6230	7230	8230	T212C156M050(2)S		
50	18.0	C	T110C186J050A(3)	4.5	4	5093	5293	5493	5693	4231	6231	7231	8231	T212C186J050(2)S		
50	18.0	C	T110C186K050A(3)	4.5	4	2379	2619	2859	3099	4232	6232	7232	8232	T212C186K050(2)S		
50	18.0	C	T110C186M050A(3)	4.5	4											
50	22.0	D	T110D226J050A(3)	5.5	4	5094	5294	5494	5694	4233	6233	7233	8233	T212D226J050(2)S		
50	22.0	D	T110D226K050A(3)	5.5	4	2380	2620	2860	3100	4234	6234	7234	8234	T212D226K050(2)S		
50	22.0	D	T110D226M050A(3)	5.5	4	2381	2621	2861	3101	4235	6235	7235	8235	T212D226M050(2)S		
60	0.0047	A	T110A472(1)060A(3)	0.3	3											
60	0.0056	A	T110A562(1)060A(3)	0.3	3											
60	0.0068	A	T110A682(1)060A(3)	0.3	3											
60	0.0082	A	T110A822(1)060A(3)	0.3	3											
60	0.01	A	T110A103(1)060A(3)	0.3	3											
60	0.012	A	T110A123(1)060A(3)	0.3	3											
60	0.015	A	T110A153(1)060A(3)	0.3	3											
60	0.018	A	T110A183(1)060A(3)	0.3	3											
60	0.022	A	T110A223(1)060A(3)	0.3	3											
60	0.027	A	T110A273(1)060A(3)	0.3	3											
60	0.033	A	T110A333(1)060A(3)	0.3	3											
60	0.039	A	T110A393(1)060A(3)	0.3	3											
60	0.047	A	T110A473(1)060A(3)	0.3	3											
60	0.056	A	T110A563(1)060A(3)	0.3	3											
60	0.068	A	T110A683(1)060A(3)	0.3	3											
60	0.082	A	T110A823(1)060A(3)	0.3	3											
60	0.1	A	T110A104(1)060A(3)	0.5	3											
60	0.12	A	T110A124(1)060A(3)	0.5	3											
60	0.15	A	T110A154(1)060A(3)	0.5	3											
60	0.18	A	T110A184(1)060A(3)	0.5	3											
60	0.22	A	T110A224(1)060A(3)	0.5	3											
60	0.27	A	T110A274(1)060A(3)	0.5	3											
60	0.33	A	T110A334(1)060A(3)	0.5	3											
60	0.39	A	T110A394(1)060A(3)	0.5	3											
60	0.47	A	T110A474(1)060A(3)	0.5	3											
60	0.56	A	T110A564(1)060A(3)	0.5	3											
60	0.68	A	T110A684(1)060A(3)	0.5	3											
60	0.82	B	T110B824(1)060A(3)	0.5	3											
60	1.0	B	T110B105(1)060A(3)	0.5	3											
VDC	µF		(see below for part options)	µA @ 25°C Max/5 Minimum	120 Hz Maximum	M (1.0)	P (0.1)	R (0.01)	S (0.001)	G (1.0)	B (0.1)	C (0.01)	D (0.001)	Part Number		
Rated Voltage	Rated Cap	Case Size Code	KEMET Part Number	DC Leakage	DF % @ 25°C	MIL-PRF-39003 (CSR13) Capacitors										

(1) To complete KEMET Part Number, insert M for ±20%, K for ±10%, or J for 5%. Designates capacitance tolerance.
 (2) To complete KEMET Part Number (T212), insert Graded failure rate - A for Not Applicable, B for .1%/k hours, C for .01%/k hours, D for .001%/k hours, or G for 1%/k hours; or insert Exponential failure rate - M for 1%/k hours, P for .1%/k hours, R for .01%/k hours, or S for .001%/k hours. Designates Reliability Level.
 (3) To complete KEMET Part Number (T110), insert Lead Material designator - S for Standard or T for 100% Matte Tin. Designates Termination finish.
 Refer to Ordering Information for additional detail.

Table 1 – Ratings & Part Number Reference cont'd

Rated Voltage	Rated Cap	Case Size Code	KEMET Part Number	DC Leakage	DF % @ 25°C	MIL-PRF-39003 (CSR13) Capacitors														
						Dash Number Reference														KEMET Equivalent Military
						Failure Rate Level (%/1,000 hours)														
						MIL-PRF-39003/1K							MIL-PRF-39003/1K							
						Exponential							Graded							
VDC	µF		(See below for part options)	µA @ 25°C Max/5 Minutes	120 Hz Maximum	M (1.0)	P (0.1)	R (0.01)	S (0.001)	G (1.0)	B (0.1)	C (0.01)	D (0.001)	Part Number						
60	1.2	B	T110B125(1)060A(3)	0.5	4															
60	1.5	B	T110B155(1)060A(3)	0.5	4															
60	1.8	B	T110B185(1)060A(3)	0.5	4															
60	2.2	B	T110B225(1)060A(3)	1.0	4															
60	2.7	B	T110B275(1)060A(3)	1.0	4															
60	3.3	B	T110B335(1)060A(3)	1.5	4															
60	3.9	B	T110B395(1)060A(3)	1.5	4															
60	4.7	C	T110C475(1)060A(3)	2.0	4															
60	5.6	C	T110C565(1)060A(3)	2.0	4															
60	6.8	C	T110C685(1)060A(3)	3.0	4															
60	8.2	C	T110C825(1)060A(3)	4.0	4															
60	10.0	C	T110C106(1)060A(3)	5.0	4															
60	12.0	C	T110C126(1)060A(3)	5.0	4															
60	15.0	D	T110D156(1)060A(3)	4.0	4															
60	18.0	D	T110D186(1)060A(3)	5.0	4															
60	22.0	D	T110D226(1)060A(3)	6.0	4															
75	0.0047	A	T110A472(1)075A(3)	0.3	2															
75	0.0056	A	T110A562(1)075A(3)	0.3	2															
75	0.0068	A	T110A682(1)075A(3)	0.3	2															
75	0.0082	A	T110A822(1)075A(3)	0.3	2															
75	0.01	A	T110A103(1)075A(3)	0.3	2															
75	0.012	A	T110A123(1)075A(3)	0.3	2															
75	0.015	A	T110A153(1)075A(3)	0.3	2															
75	0.018	A	T110A183(1)075A(3)	0.3	2															
75	0.022	A	T110A223(1)075A(3)	0.3	2															
75	0.027	A	T110A273(1)075A(3)	0.3	2															
75	0.033	A	T110A333(1)075A(3)	0.3	2															
75	0.039	A	T110A393(1)075A(3)	0.3	2															
75	0.047	A	T110A473(1)075A(3)	0.3	2															
75	0.056	A	T110A563(1)075A(3)	0.3	2															
75	0.068	A	T110A683(1)075A(3)	0.3	2															
75	0.082	A	T110A823(1)075A(3)	0.3	2															
75	0.1	A	T110A104J075A(3)	0.3	2	5095	5295	5495	5695						T212A104J075(2)S					
75	0.1	A	T110A104K075A(3)	0.3	2	2382	2622	2862	3102						T212A104K075(2)S					
75	0.1	A	T110A104M075A(3)	0.3	2	2383	2623	2863	3103						T212A104M075(2)S					
75	0.12	A	T110A124J075A(3)	0.3	2	5096	5296	5496	5696						T212A124J075(2)S					
75	0.12	A	T110A124K075A(3)	0.3	2	2384	2624	2864	3104						T212A204K075(2)S					
75	0.12	A	T110A124M075A(3)	0.3	2															
75	0.15	A	T110A154J075A(3)	0.3	2	5097	5297	5497	5697						T212A154J075(2)S					
75	0.15	A	T110A154K075A(3)	0.3	2	2385	2625	2865	3105						T212A154K075(2)S					
75	0.15	A	T110A154M075A(3)	0.3	2	2386	2626	2866	3106						T212A154M075(2)S					
75	0.18	A	T110A184J075A(3)	0.3	2	5098	5298	5498	5698						T212A184J075(2)S					
75	0.18	A	T110A184K075A(3)	0.3	2	2387	2627	2867	3107						T212A184K075(2)S					
75	0.18	A	T110A184M075A(3)	0.3	2															
VDC	µF		(see below for part options)	µA @ 25°C Max/5 Minutes	120 Hz Maximum	M (1.0)	P (0.1)	R (0.01)	S (0.001)	G (1.0)	B (0.1)	C (0.01)	D (0.001)	Part Number						
Rated Voltage	Rated Cap	Case Size Code	KEMET Part Number	DC Leakage	DF % @ 25°C	MIL-PRF-39003 (CSR13) Capacitors														

(1) To complete KEMET Part Number, insert M for ±20%, K for ±10%, or J for 5%. Designates capacitance tolerance.
 (2) To complete KEMET Part Number (T212), insert Graded failure rate - A for Not Applicable, B for .1%/k hours, C for .01%/k hours, D for .001%/k hours, or G for 1%/k hours; or insert Exponential failure rate - M for 1%/k hours, P for .1%/k hours, R for .01%/k hours, or S for .001%/k hours. Designates Reliability Level.
 (3) To complete KEMET Part Number (T110), insert Lead Material designator - S for Standard or T for 100% Matte Tin. Designates Termination finish.
 Refer to Ordering Information for additional detail.

Table 1 – Ratings & Part Number Reference cont'd

Rated Voltage	Rated Cap	Case Size Code	KEMET Part Number	DC Leakage	DF % @ 25°C	MIL-PRF-39003 (CSR13) Capacitors										KEMET Equivalent Military Part Number		
						Dash Number Reference												
						Failure Rate Level (%/1,000 hours)												
						MIL-PRF-39003/1K				MIL-PRF-39003/1K								
						Exponential				Graded								
VDC	µF		(See below for part options)	µA @ 25°C Max/5 Minutes	120 Hz Maximum	M (1.0)	P (0.1)	R (0.01)	S (0.001)	G (1.0)	B (0.1)	C (0.01)	D (0.001)	Part Number				
75	0.22	A	T110A224J075A(3)	0.3	2	5099	5299	5499	5699					T212A224J075(2)S				
75	0.22	A	T110A224K075A(3)	0.3	2	2388	2628	2868	3108					T212A224K075(2)S				
75	0.22	A	T110A224M075A(3)	0.3	2	2389	2629	2869	3109					T212A224M075(2)S				
75	0.27	A	T110A274J075A(3)	0.3	2	5100	5300	5500	5700					T212A274J075(2)S				
75	0.27	A	T110A274K075A(3)	0.3	2	2390	2630	2870	3110					T212A274K075(2)S				
75	0.27	A	T110A274M075A(3)	0.3	2													
75	0.33	A	T110A334J075A(3)	0.3	2	5101	5301	5501	5701					T212A334J075(2)S				
75	0.33	A	T110A334K075A(3)	0.3	2	2391	2631	2871	3111					T212A334K075(2)S				
75	0.33	A	T110A334M075A(3)	0.3	2	2392	2632	2872	3112					T212A334M075(2)S				
75	0.39	A	T110A394J075A(3)	0.3	2	5102	5302	5502	5702					T212A394J075(2)S				
75	0.39	A	T110A394K075A(3)	0.3	2	2393	2633	2873	3113					T212A394K075(2)S				
75	0.39	A	T110A394M075A(3)	0.3	2													
75	0.47	A	T110A474J075A(3)	0.3	2	5103	5303	5503	5703					T212A474J075(2)S				
75	0.47	A	T110A474K075A(3)	0.3	2	2394	2634	2874	3114					T212A474K075(2)S				
75	0.47	A	T110A474M075A(3)	0.3	2	2395	2635	2875	3115					T212A474M075(2)S				
75	0.56	A	T110A564J075A(3)	0.3	2	5104	5304	5504	5704					T212A564J075(2)S				
75	0.56	A	T110A564K075A(3)	0.3	2	2396	2636	2876	3116					T212A564K075(2)S				
75	0.56	A	T110A564M075A(3)	0.3	2													
75	0.68	A	T110A684J075A(3)	0.3	2	5105	5305	5505	5705					T212A684J075(2)S				
75	0.68	A	T110A684K075A(3)	0.3	2	2397	2637	2877	3117					T212A684K075(2)S				
75	0.68	A	T110A684M075A(3)	0.3	2	2398	2638	2878	3118					T212A684M075(2)S				
75	0.82	B	T110B824J075A(3)	0.3	2	5106	5306	5506	5706					T212B824J075(2)S				
75	0.82	B	T110B824K075A(3)	0.3	2	2399	2639	2879	3119					T212B824K075(2)S				
75	0.82	B	T110B824M075A(3)	0.3	2													
75	1.0	B	T110B105J075A(3)	0.3	2	5107	5307	5507	5707					T212B105J075(2)S				
75	1.0	B	T110B105K075A(3)	0.3	2	2400	2640	2880	3120					T212B105K075(2)S				
75	1.0	B	T110B105M075A(3)	0.3	2	2401	2641	2881	3121					T212B105M075(2)S				
75	1.2	B	T110B125J075A(3)	0.3	4	5108	5308	5508	5708					T212B125J075(2)S				
75	1.2	B	T110B125K075A(3)	0.3	4	2402	2642	2882	3122					T212B125K075(2)S				
75	1.2	B	T110B125M075A(3)	0.3	4													
75	1.5	B	T110B155J075A(3)	0.6	4	5109	5309	5509	5709					T212B155J075(2)S				
75	1.5	B	T110B155K075A(3)	0.6	4	2403	2643	2883	3123					T212B155K075(2)S				
75	1.5	B	T110B155M075A(3)	0.6	4	2404	2644	2884	3124					T212B155M075(2)S				
75	1.8	B	T110B185J075A(3)	0.7	4	5110	5310	5510	5710					T212B185J075(2)S				
75	1.8	B	T110B185K075A(3)	0.7	4	2405	2645	2885	3125					T212B185K075(2)S				
75	1.8	B	T110B185M075A(3)	0.7	4													
75	2.2	B	T110B225J075A(3)	0.8	4	5111	5311	5511	5711					T212B225J075(2)S				
75	2.2	B	T110B225K075A(3)	0.8	4	2406	2646	2886	3126					T212B225K075(2)S				
75	2.2	B	T110B225M075A(3)	0.8	4	2407	2647	2887	3127	4278	6278	7278	8278	T212B225M075(2)S				
75	2.7	B	T110B275J075A(3)	1.0	4	5112	5312	5512	5712	4279	6279	7279	8279	T212B275J075(2)S				
75	2.7	B	T110B275K075A(3)	1.0	4	2408	2648	2888	3128	4280	6280	7280	8280	T212B275K075(2)S				
75	2.7	B	T110B275M075A(3)	1.2	4													
75	3.3	B	T110B335J075A(3)	1.2	4	5113	5313	5513	5713	4281	6281	7281	8281	T212B335J075(2)S				
75	3.3	B	T110B335K075A(3)	1.2	4	2409	2649	2889	3129	4282	6282	7282	8282	T212B335K075(2)S				
75	3.3	B	T110B335M075A(3)	1.2	4													
VDC	µF	Case Size Code	(see below for part options)	µA @ 25°C Max/5 Minimum	120 Hz Maximum	M (1.0)	P (0.1)	R (0.01)	S (0.001)	G (1.0)	B (0.1)	C (0.01)	D (0.001)	Part Number				
Rated Voltage	Rated Cap	Case Size Code	KEMET Part Number	DC Leakage	DF % @ 25°C	MIL-PRF-39003 (CSR13) Capacitors												

(1) To complete KEMET Part Number, insert M for ±20%, K for ±10%, or J for 5%. Designates capacitance tolerance.

(2) To complete KEMET Part Number (T212), insert Graded failure rate - A for Not Applicable, B for .1%/k hours, C for .01%/k hours, D for .001%/k hours, or G for 1%/k hours; or insert Exponential failure rate - M for 1%/k hours, P for .1%/k hours, R for .01%/k hours, or S for .001%/k hours. Designates Reliability Level.

(3) To complete KEMET Part Number (T110), insert Lead Material designator - S for Standard or T for 100% Matte Tin. Designates Termination finish.

Refer to Ordering Information for additional detail.

Table 1 – Ratings & Part Number Reference cont'd

Rated Voltage	Rated Cap	Case Size Code	KEMET Part Number	DC Leakage	DF % @ 25°C	MIL-PRF-39003 (CSR13) Capacitors										KEMET Equivalent Military Part Number
						Dash Number Reference										
						Failure Rate Level (%/1,000 hours)										
						MIL-PRF-39003/1K					MIL-PRF-39003/1K					
						Exponential					Graded					
VDC	µF		(See below for part options)	µA @ 25°C Max/5 Minutes	120 Hz Maximum	M (1.0)	P (0.1)	R (0.01)	S (0.001)	G (1.0)	B (0.1)	C (0.01)	D (0.001)	Part Number		
75	3.3	B	T110B335M075A(3)	1.2	4	2410	2650	2890	3130	4283	6283	7283	8283	T212B335M075(2)S		
75	3.9	B	T110B395J075A(3)	1.5	4	5114	5314	5514	5714	4284	6284	7284	8284	T212B395J075(2)S		
75	3.9	B	T110B395K075A(3)	1.5	4	2411	2651	2891	3131	4285	6285	7285	8285	T212B395K075(2)S		
75	4.7	C	T110C475J075A(3)	3.0	4	5115	5315	5515	5715	4286	6286	7286	8286	T212C475J075(2)S		
75	4.7	C	T110C475K075A(3)	3.0	4	2412	2652	2892	3132	4287	6287	7287	8287	T212C475K075(2)S		
75	4.7	C	T110C475M075A(3)	3.0	4	2413	2653	2893	3133	4288	6288	7288	8288	T212C475M075(2)S		
75	5.6	C	T110C565J075A(3)	3.0	4	5116	5316	5516	5716	4289	6289	7289	8289	T212C565J075(2)S		
75	5.6	C	T110C565K075A(3)	3.0	4	2414	2654	2894	3134	4290	6290	7290	8290	T212C565K075(2)S		
75	5.6	C	T110C565M075A(3)	3.0	4											
75	6.8	C	T110C685J075A(3)	5.0	4	5117	5317	5517	5717	4291	6291	7291	8291	T212C685J075(2)S		
75	6.8	C	T110C685K075A(3)	5.0	4	2415	2655	2895	3135	4292	6292	7292	8292	T212C685K075(2)S		
75	6.8	C	T110C685M075A(3)	5.0	4	2416	2656	2896	3136	4293	6293	7293	8293	T212C685M075(2)S		
75	8.2	C	T110C825J075A(3)	5.0	4	5118	5318	5518	5718	4294	6294	7294	8294	T212C825J075(2)S		
75	8.2	C	T110C825K075A(3)	5.0	4	2417	2657	2897	3137	4295	6295	7295	8295	T212C825K075(2)S		
75	8.2	C	T110C825M075A(3)	5.0	4											
75	10.0	C	T110C106J075A(3)	5.0	4	5119	5319	5519	5719	4296	6296	7296	8296	T212C106J075(2)S		
75	10.0	C	T110C106K075A(3)	5.0	4	2418	2658	2898	3138	4297	6297	7297	8297	T212C106K075(2)S		
75	10.0	C	T110C106M075A(3)	5.0	4	2419	2659	2899	3139	4298	6298	7298	8298	T212C106M075(2)S		
75	12.0	D	T110D126J075A(3)	5.0	4	5120	5320	5520	5720	4299	6299	7299	8299	T212D126J075(2)S		
75	12.0	D	T110D126K075A(3)	5.0	4	2420	2660	2900	3140	4300	6300	7300	8300	T212D126K075(2)S		
75	12.0	D	T110D126M075A(3)	5.0	4											
75	15.0	D	T110D156J075A(3)	7.0	4	5121	5321	5521	5721	4301	6301	7301	8301	T212D156J075(2)S		
75	15.0	D	T110D156K075A(3)	7.0	4	2421	2661	2901	3141	4302	6302	7302	8302	T212D156K075(2)S		
75	15.0	D	T110D156M075A(3)	7.0	4	2422	2662	2902	3142	4303	6303	7303	8303	T212D156M075(2)S		
100	0.0047	A	T110A472J100A(3)	0.3	2	5122	5322	5522	5722	4304	6304	7304	*	T212A472J100(2)S		
100	0.0047	A	T110A472K100A(3)	0.3	2	2423	2663	2903	3143	4305	6305	7305	*	T212A472K100(2)S		
100	0.0047	A	T110A472M100A(3)	0.3	2	2424	2664	2904	3144	4306	6306	7306	*	T212A472M100(2)S		
100	0.0056	A	T110A562J100A(3)	0.3	2	5123	5323	5523	5723	4307	6307	7307	*	T212A562J100(2)S		
100	0.0056	A	T110A562K100A(3)	0.3	2	2425	2665	2905	3145	4308	6308	7308	*	T212A562K100(2)S		
100	0.0056	A	T110A562M100A(3)	0.3	2								*			
100	0.0068	A	T110A682J100A(3)	0.3	2	5124	5324	5524	5724	4309	6309	7309	*	T212A682J100(2)S		
100	0.0068	A	T110A682K100A(3)	0.3	2	2426	2666	2906	3146	4310	6310	7310	*	T212A682K100(2)S		
100	0.0068	A	T110A682M100A(3)	0.3	2	2427	2667	2907	3147	4311	6311	7311	*	T212A682M100(2)S		
100	0.0082	A	T110A822J100A(3)	0.3	2	5125	5325	5525	5725	4312	6312	7312	*	T212A822J100(2)S		
100	0.0082	A	T110A822K100A(3)	0.3	2	2428	2668	2908	3148	4313	6313	7313	*	T212A822K100(2)S		
100	0.0082	A	T110A822M100A(3)	0.3	2								*			
100	0.01	A	T110A103J100A(3)	0.3	2	5126	5326	5526	5726	4313	6314	7314	*	T212A103J100(2)S		
100	0.01	A	T110A103K100A(3)	0.3	2	2429	2669	2909	3149	4315	6315	7315	*	T212A103K100(2)S		
100	0.01	A	T110A103M100A(3)	0.3	2	2430	2670	2910	3150	4316	6316	7316	*	T212A103M100(2)S		
100	0.012	A	T110A123J100A(3)	0.3	2	5127	5327	5527	5727	4317	6317	7317	*	T212A123J100(2)S		
100	0.012	A	T110A123K100A(3)	0.3	2	2431	2671	2911	3151	4318	6318	7318	*	T212A123K100(2)S		
100	0.012	A	T110A123M100A(3)	0.3	2								*			
100	0.015	A	T110A153J100A(3)	0.3	2	5128	5328	5528	5728	4319	6319	7319	*	T212A153J100(2)S		
VDC	µF		(see below for part options)	µA @ 25°C Max/5 Minimum	120 Hz Maximum	M (1.0)	P (0.1)	R (0.01)	S (0.001)	G (1.0)	B (0.1)	C (0.01)	D (0.001)	Part Number		
Rated Voltage	Rated Cap	Case Size Code	KEMET Part Number	DC Leakage	DF % @ 25°C	MIL-PRF-39003 (CSR13) Capacitors										

(1) To complete KEMET Part Number, insert M for ±20%, K for ±10%, or J for 5%. Designates capacitance tolerance.

(2) To complete KEMET Part Number (T212), insert Graded failure rate - A for Not Applicable, B for .1%/k hours, C for .01%/k hours, D for .001%/k hours, or G for 1%/k hours; or insert Exponential failure rate - M for 1%/k hours, P for .1%/k hours, R for .01%/k hours, or S for .001%/k hours. Designates Reliability Level.

(3) To complete KEMET Part Number (T110), insert Lead Material designator - S for Standard or T for 100% Matte Tin. Designates Termination finish.

Refer to Ordering Information for additional detail.

Table 1 – Ratings & Part Number Reference cont'd

Rated Voltage	Rated Cap	Case Size Code	KEMET Part Number	DC Leakage	DF % @ 25°C	MIL-PRF-39003 (CSR13) Capacitors										KEMET Equivalent Military
						Dash Number Reference										
						Failure Rate Level (%/1,000 hours)										
						MIL-PRF-39003/1K					MIL-PRF-39003/1K					
						Exponential					Graded					
VDC	µF		(See below for part options)	µA @ 25°C Max/5 Minutes	120 Hz Maximum	M (1.0)	P (0.1)	R (0.01)	S (0.001)	G (1.0)	B (0.1)	C (0.01)	D (0.001)	Part Number		
100	0.015	A	T110A153K100A(3)	0.3	2	2432	2672	2912	3152	4320	6320	7320	*	T212A153K100(2)S		
100	0.015	A	T110A153M100A(3)	0.3	2	2433	2673	2913	3153	4321	6321	7321	*	T212A153M100(2)S		
100	0.018	A	T110A183J100A(3)	0.3	2	5129	5329	5529	5729	4322	6322	7322	*	T212A183J100(2)S		
100	0.018	A	T110A183K100A(3)	0.3	2	2434	2674	2914	3154	4323	6323	7323	*	T212A183K100(2)S		
100	0.018	A	T110A183M100A(3)	0.3	2								*			
100	0.022	A	T110A223J100A(3)	0.3	2	5130	5330	5530	5730	4324	6324	7324	*	T212A223J100(2)S		
100	0.022	A	T110A223K100A(3)	0.3	2	2435	2675	2915	3155	4325	6325	7325	*	T212A223K100(2)S		
100	0.022	A	T110A223M100A(3)	0.3	2	2436	2676	2916	3156	4326	6326	7326	*	T212A223M100(2)S		
100	0.027	A	T110A273J100A(3)	0.3	2	5131	5331	5531	5731	4327	6327	7327	*	T212A273J100(2)S		
100	0.027	A	T110A273K100A(3)	0.3	2	2437	2677	2917	3157	4328	6328	7328	*	T212A273K100(2)S		
100	0.027	A	T110A273M100A(3)	0.3	2								*			
100	0.033	A	T110A333J100A(3)	0.3	2	5132	5332	5532	5732	4329	6329	7329	*	T212A333J100(2)S		
100	0.033	A	T110A333K100A(3)	0.3	2	2438	2678	2918	3158	4330	6330	7330	*	T212A333K100(2)S		
100	0.033	A	T110A333M100A(3)	0.3	2	2439	2679	2919	3159	4331	6331	7331	*	T212A333M100(2)S		
100	0.039	A	T110A393J100A(3)	0.3	2	5133	5333	5533	5733	4332	6332	7332	*	T212A393J075(2)S		
100	0.039	A	T110A393K100A(3)	0.3	2	2440	2680	2920	3160	4333	6333	7333	*	T212A393K075(2)S		
100	0.039	A	T110A393M100A(3)	0.3	2								*			
100	0.047	A	T110A473J100A(3)	0.3	2	5134	5334	5534	5734	4334	6334	7334	*	T212A473J100(2)S		
100	0.047	A	T110A473K100A(3)	0.3	2	2441	2681	2921	3161	4335	6335	7335	*	T212A473K100(2)S		
100	0.047	A	T110A473M100A(3)	0.3	2	2442	2682	2922	3162	4336	6336	7336	*	T212A473M100(2)S		
100	0.056	A	T110A563J100A(3)	0.3	2	5135	5335	5535	5735	4337	6337	7337	*	T212A563J100(2)S		
100	0.056	A	T110A563K100A(3)	0.3	2	2443	2683	2923	3163	4338	6338	7338	*	T212A563K100(2)S		
100	0.056	A	T110A563M100A(3)	0.3	2								*			
100	0.068	A	T110A683J100A(3)	0.3	2	5136	5336	5536	5736	4339	6339	7339	*	T212A683J100(2)S		
100	0.068	A	T110A683K100A(3)	0.3	2	2444	2684	2924	3164	4340	6340	7340	*	T212A683K100(2)S		
100	0.068	A	T110A683M100A(3)	0.3	2	2445	2685	2925	3165	4341	6341	7341	*	T212A683M100(2)S		
100	0.082	A	T110A823J100A(3)	0.3	2	5137	5337	5537	5737	4342	6342	7342	*	T212A823J100(2)S		
100	0.082	A	T110A823K100A(3)	0.3	2	2446	2686	2926	3166	4343	6343	7343	*	T212A823K100(2)S		
100	0.082	A	T110A823M100A(3)	0.3	2								*			
100	0.1	A	T110A104J100A(3)	0.3	2	5138	5338	5538	5738	4344	6344	7344	*	T212A104J100(2)S		
100	0.1	A	T110A104K100A(3)	0.3	2	2447	2687	2927	3167	4345	6345	7345	*	T212A104K100(2)S		
100	0.1	A	T110A104M100A(3)	0.3	2	2448	2688	2928	3168	4346	6346	7346	*	T212A104M100(2)S		
100	0.12	A	T110A124J100A(3)	0.3	2	5139	5339	5539	5739	4347	6347	7347	*	T212A124J100(2)S		
100	0.12	A	T110A124K100A(3)	0.3	2	2449	2689	2929	3169	4348	6348	7348	*	T212A124K100(2)S		
100	0.12	A	T110A124M100A(3)	0.3	2								*			
100	0.15	A	T110A154J100A(3)	0.3	2	5140	5340	5540	5740	4349	6349	7349	*	T212A154J100(2)S		
100	0.15	A	T110A154K100A(3)	0.3	2	2450	2690	2930	3170	4350	6350	7350	*	T212A154K100(2)S		
100	0.15	A	T110A154M100A(3)	0.3	2	2451	2691	2931	3171	4351	6351	7351	*	T212A154M100(2)S		
100	0.18	A	T110A184J100A(3)	0.3	2	5141	5341	5541	5741	4352	6352	7352	*	T212A184J100(2)S		
100	0.18	A	T110A184K100A(3)	0.3	2	2452	2692	2932	3172	4353	6353	7353	*	T212A184K100(2)S		
100	0.18	A	T110A184M100A(3)	0.3	2								*			
100	0.22	A	T110A224J100A(3)	0.3	2	5142	5342	5542	5742	4354	6354	7354	*	T212A224J100(2)S		
100	0.22	A	T110A224K100A(3)	0.3	2	2453	2693	2933	3173	4355	6355	7355	*	T212A224K100(2)S		
100	0.22	A	T110A224M100A(3)	0.3	2	2454	2694	2934	3174	4356	6356	7356	*	T212A224M100(2)S		
VDC	µF	Case Size Code	(see below for part options)	µA @ 25°C Max/5 Minimum	120 Hz Maximum	M (1.0)	P (0.1)	R (0.01)	S (0.001)	G (1.0)	B (0.1)	C (0.01)	D (0.001)	Part Number		
Rated Voltage	Rated Cap	Case Size Code	KEMET Part Number	DC Leakage	DF % @ 25°C	MIL-PRF-39003 (CSR13) Capacitors										

(1) To complete KEMET Part Number, insert M for ±20%, K for ±10%, or J for 5%. Designates capacitance tolerance.
 (2) To complete KEMET Part Number (T212), insert Graded failure rate - A for Not Applicable, B for .1%/k hours, C for .01%/k hours, D for .001%/k hours, or G for 1%/k hours; or insert Exponential failure rate - M for 1%/k hours, P for .1%/k hours, R for .01%/k hours, or S for .001%/k hours. Designates Reliability Level.
 (3) To complete KEMET Part Number (T110), insert Lead Material designator - S for Standard or T for 100% Matte Tin. Designates Termination finish.
 Refer to Ordering Information for additional detail.

Table 1 – Ratings & Part Number Reference cont'd

Rated Voltage	Rated Cap	Case Size Code	KEMET Part Number	DC Leakage	DF % @ 25°C	MIL-PRF-39003 (CSR13) Capacitors													
						Dash Number Reference													KEMET Equivalent Military
						Failure Rate Level (%/1,000 hours)													
						MIL-PRF-39003/1K						MIL-PRF-39003/1K							
						Exponential						Graded							
VDC	µF		(See below for part options)	µA @ 25°C Max/5 Minutes	120 Hz Maximum	M (1.0)	P (0.1)	R (0.01)	S (0.001)	G (1.0)	B (0.1)	C (0.01)	D (0.001)	Part Number					
100	0.27	A	T110A274J100A(3)	0.3	2	5143	5343	5543	5743	4357	6357	7357	*	T212A274J100(2)S					
100	0.27	A	T110A274K100A(3)	0.3	2	2455	2695	2935	3175	4358	6358	7358	*	T212A274K100(2)S					
100	0.27	A	T110A274M100A(3)	0.3	2								*						
100	0.33	A	T110A334J100A(3)	0.3	2	5144	5344	5544	5744	4359	6359	7359	*	T212A334J100(2)S					
100	0.33	A	T110A334K100A(3)	0.3	2	2456	2696	2936	3176	4360	6360	7360	*	T212A334K100(2)S					
100	0.33	A	T110A334M100A(3)	0.3	2	2457	2697	2937	3177	4361	6361	7361	*	T212A334M100(2)S					
100	0.39	A	T110A394J100A(3)	0.3	2	5145	5345	5545	5745	4362	6362	7362	*	T212A394J100(2)S					
100	0.39	A	T110A394K100A(3)	0.3	2	2458	2698	2938	3178	4363	6363	7363	*	T212A394K100(2)S					
100	0.39	A	T110A394M100A(3)	0.3	2								*						
100	0.47	A	T110A474J100A(3)	0.3	2	5146	5346	5546	5749	4364	6364	7364	*	T212A474J100(2)S					
100	0.47	A	T110A474K100A(3)	0.3	2	2459	2699	2939	3179	4365	6365	7365	*	T212A474K100(2)S					
100	0.47	A	T110A474M100A(3)	0.3	2	2460	2700	2940	3180	4366	6366	7366	*	T212A474M100(2)S					
100	0.56	A	T110A564J100A(3)	0.3	2	5147	5347	5547	5747	4367	6367	7367	*	T212A564J100(2)S					
100	0.56	A	T110A564K100A(3)	0.3	2	2461	2701	2941	3181	4368	6368	7368	*	T212A564K100(2)S					
100	0.56	A	T110A564M100A(3)	0.3	2								*						
100	0.68	B	T110B684J100A(3)	0.3	2	5148	5348	5548	5748	4369	6369	7369	*	T212B684J100(2)S					
100	0.68	B	T110B684K100A(3)	0.3	2	2462	2702	2942	3182	4370	6370	7370	*	T212B684K100(2)S					
100	0.68	B	T110B684M100A(3)	0.3	2	2463	2703	2943	3183	4371	6371	7371	*	T212B684M100(2)S					
100	0.82	B	T110B824J100A(3)	0.4	2	5149	5349	5549	5749	4372	6372	7372	*	T212B824J100(2)S					
100	0.82	B	T110B824K100A(3)	0.4	2	2464	2704	2944	3184	4373	6373	7373	*	T212B824K100(2)S					
100	0.82	B	T110B824M100A(3)	0.4	2								*						
100	1.0	B	T110B105J100A(3)	0.5	2	5150	5350	5550	5750	4374	6374	7374	*	T212B105J100(2)S					
100	1.0	B	T110B105K100A(3)	0.5	2	2465	2705	2945	3185	4375	6375	7375	*	T212B105K100(2)S					
100	1.0	B	T110B105M100A(3)	0.5	2	2466	2706	2946	3186	4376	6376	7376	*	T212B105M100(2)S					
100	1.2	B	T110B125J100A(3)	0.5	3	5151	5351	5551	5751	4377	6377	7377	*	T212B125J100(2)S					
100	1.2	B	T110B125K100A(3)	0.5	3	2467	2707	2947	3187	4378	6378	7378	*	T212B125K100(2)S					
100	1.2	B	T110B125M100A(3)	0.5	3								*						
100	1.5	B	T110B155J100A(3)	0.7	3	5152	5352	5552	5752	4379	6379	7379	*	T212B155J100(2)S					
100	1.5	B	T110B155K100A(3)	0.7	3	2468	2708	2948	3188	4380	6380	7380	*	T212B155K100(2)S					
100	1.5	B	T110B155M100A(3)	0.7	3	2469	2709	2949	3189	4381	6381	7381	*	T212B155M100(2)S					
100	1.8	B	T110B185J100A(3)	0.7	3	5153	5353	5553	5753	4382	6382	7382	*	T212B185J100(2)S					
100	1.8	B	T110B185K100A(3)	0.7	3	2470	2710	2950	3190	4383	6383	7383	*	T212B185K100(2)S					
100	1.8	B	T110B185M100A(3)	0.7	3								*						
100	2.2	B	T110B225J100A(3)	0.9	3	5154	5354	5554	5754	4384	6384	7384	*	T212B225J100(2)S					
100	2.2	B	T110B225K100A(3)	0.9	3	2471	2711	2951	3191	4385	6385	7385	*	T212B225K100(2)S					
100	2.2	B	T110B225M100A(3)	0.9	3	2472	2712	2952	3192	4386	6386	7386	*	T212B225M100(2)S					
100	2.7	B	T110B275J100A(3)	1.1	3	5155	5355	5555	5755	4387	6387	7387	*	T212B275J100(2)S					
100	2.7	B	T110B275K100A(3)	1.1	3	2473	2713	2953	3193	4388	6388	7388	*	T212B275K100(2)S					
100	2.7	B	T110B275M100A(3)	1.1	3								*						
100	3.3	C	T110C335J100A(3)	1.5	3	5156	5356	5556	5756	4389	6389	*	*	T212C335J100(2)S					
100	3.3	C	T110C335K100A(3)	1.5	3	5157	5357	5557	5757	4390	6390	*	*	T212C335K100(2)S					
100	3.3	C	T110C335M100A(3)	1.5	3	5158	5358	5558	5758	4391	6391	*	*	T212C335M100(2)S					
100	3.9	C	T110C395J100A(3)	1.5	3	5159	5359	5559	5759	4392	6392	*	*	T212C395J100(2)S					
100	3.9	C	T110C395K100A(3)	1.5	3	5160	5360	5560	5760	4393	6393	*	*	T212C395K100(2)S					
VDC	µF		(see below for part options)	µA @ 25°C Max/5 Minimum	120 Hz Maximum	M (1.0)	P (0.1)	R (0.01)	S (0.001)	G (1.0)	B (0.1)	C (0.01)	D (0.001)	Part Number					
Rated Voltage	Rated Cap	Case Size Code	KEMET Part Number	DC Leakage	DF % @ 25°C	MIL-PRF-39003 (CSR13) Capacitors													

(1) To complete KEMET Part Number, insert M for ±20%, K for ±10%, or J for 5%. Designates capacitance tolerance.
 (2) To complete KEMET Part Number (T212), insert Graded failure rate - A for Not Applicable, B for .1%/k hours, C for .01%/k hours, D for .001%/k hours, or G for 1%/k hours; or insert Exponential failure rate - M for 1%/k hours, P for .1%/k hours, R for .01%/k hours, or S for .001%/k hours. Designates Reliability Level.
 (3) To complete KEMET Part Number (T110), insert Lead Material designator - S for Standard or T for 100% Matte Tin. Designates Termination finish.
 Refer to Ordering Information for additional detail.

Table 1 – Ratings & Part Number Reference cont'd

Rated Voltage	Rated Cap	Case Size Code	KEMET Part Number	DC Leakage	DF % @ 25°C	MIL-PRF-39003 (CSR13) Capacitors										KEMET Equivalent Military
						Dash Number Reference										
						Failure Rate Level (%/1,000 hours)										
						MIL-PRF-39003/1K					MIL-PRF-39003/1K					
						Exponential					Graded					
VDC	µF		(See below for part options)	µA @ 25°C Max/5 Minutes	120 Hz Maximum	M (1.0)	P (0.1)	R (0.01)	S (0.001)	G (1.0)	B (0.1)	C (0.01)	D (0.001)	Part Number		
100	4.7	C	T110C475J100A(3)	2.5	3	5161	5361	5561	5761	4394	6394	*	*	T212C475J100(2)S		
100	4.7	C	T110C475K100A(3)	2.5	3	5162	5362	5562	5762	4395	6395	*	*	T212C475K100(2)S		
100	4.7	C	T110C475M100A(3)	2.5	3	5163	5363	5563	5763	4396	6396	*	*	T212C475M100(2)S		
100	5.6	C	T110C565J100A(3)	2.5	3	5164	5364	5564	5764	4397	6397	*	*	T212C565J100(2)S		
100	5.6	C	T110C565K100A(3)	2.5	3	5165	5365	5565	5765	4398	6398	*	*	T212C565K100(2)S		
100	6.80	C	T110C685J100A(3)	2.5	3	5166	5366	5566	5766	4399	6399	*	*	T212C685J100(2)S		
100	6.80	C	T110C685K100A(3)	2.5	3	5167	5367	5567	5767	4400	6400	*	*	T212C685K100(2)S		
100	6.80	C	T110C685M100A(3)	2.5	3	5168	5368	5568	5768	4401	6401	*	*	T212C685M100(2)S		
100	8.20	D	T110D825(1)100A(3)	5.0	3											
100	10.0	D	T110D106(1)100A(3)	5.0	3											
125	0.0047	A	T110A472(1)125A(3)	0.5	3											
125	0.0056	A	T110A562(1)125A(3)	0.5	3											
125	0.0068	A	T110A682(1)125A(3)	0.5	3											
125	0.0082	A	T110A822(1)125A(3)	0.5	3											
125	0.01	A	T110A103(1)125A(3)	0.5	3											
125	0.012	A	T110A123(1)125A(3)	0.5	3											
125	0.015	A	T110A153(1)125A(3)	0.5	3											
125	0.018	A	T110A183(1)125A(3)	0.5	3											
125	0.022	A	T110A223(1)125A(3)	0.5	3											
125	0.027	A	T110A273(1)125A(3)	0.5	3											
125	0.033	A	T110A333(1)125A(3)	0.5	3											
125	0.039	A	T110A393(1)125A(3)	1.5	3											
125	0.047	A	T110A473(1)125A(3)	1.5	3											
125	0.056	A	T110A563(1)125A(3)	1.5	3											
125	0.068	A	T110A683(1)125A(3)	1.5	3											
125	0.082	A	T110A823(1)125A(3)	1.5	3											
125	0.1	A	T110A104(1)125A(3)	1.5	3											
125	0.12	A	T110A124(1)125A(3)	1.5	3											
125	0.15	A	T110A154(1)125A(3)	1.5	3											
125	0.18	A	T110A184(1)125A(3)	1.5	3											
125	0.22	A	T110A224(1)125A(3)	1.5	3											
125	0.27	A	T110A274(1)125A(3)	1.5	3											
125	0.33	A	T110A334(1)125A(3)	1.5	3											
125	0.39	B	T110B394(1)125A(3)	1.5	3											
125	0.47	B	T110B474(1)125A(3)	1.5	3											
125	0.56	B	T110B564(1)125A(3)	1.5	3											
125	0.68	B	T110B684(1)125A(3)	1.5	3											
125	0.82	B	T110B824(1)125A(3)	1.5	3											
125	1.0	B	T110B105(1)125A(3)	1.5	3											
125	1.2	B	T110B125(1)125A(3)	1.5	3											
125	1.5	B	T110B155(1)125A(3)	1.5	3											
125	1.8	B	T110B185(1)125A(3)	1.5	3											
125	2.2	B	T110B225(1)125A(3)	1.5	3											
125	2.7	C	T110C275(1)125A(3)	2.0	3											
VDC	µF		(see below for part options)	µA @ 25°C Max/5 Minimum	120 Hz Maximum	M (1.0)	P (0.1)	R (0.01)	S (0.001)	G (1.0)	B (0.1)	C (0.01)	D (0.001)	Part Number		
Rated Voltage	Rated Cap	Case Size Code	KEMET Part Number	DC Leakage	DF % @ 25°C	MIL-PRF-39003 (CSR13) Capacitors										

(1) To complete KEMET Part Number, insert M for ±20%, K for ±10%, or J for 5%. Designates capacitance tolerance.
 (2) To complete KEMET Part Number (T212), insert Graded failure rate - A for Not Applicable, B for .1%/k hours, C for .01%/k hours, D for .001%/k hours, or G for 1%/k hours; or insert Exponential failure rate - M for 1%/k hours, P for .1%/k hours, R for .01%/k hours, or S for .001%/k hours. Designates Reliability Level.
 (3) To complete KEMET Part Number (T110), insert Lead Material designator - S for Standard or T for 100% Matte Tin. Designates Termination finish.
 Refer to Ordering Information for additional detail.

Table 1 – Ratings & Part Number Reference cont'd

Rated Voltage	Rated Cap	Case Size Code	KEMET Part Number	DC Leakage	DF % @ 25°C	MIL-PRF-39003 (CSR13) Capacitors									
						Dash Number Reference								KEMET Equivalent Military	
						Failure Rate Level (%/1,000 hours)									
						MIL-PRF-39003/1K				MIL-PRF-39003/1K					
						Exponential				Graded					
VDC	µF		(See below for part options)	µA @ 25°C Max/5 Minutes	120 Hz Maximum	M (1.0)	P (0.1)	R (0.01)	S (0.001)	G (1.0)	B (0.1)	C (0.01)	D (0.001)	Part Number	
125	3.3	C	T110C335(1)125A(3)	2.0	3										
125	3.9	C	T110C395(1)125A(3)	2.0	3										
125	4.7	C	T110C475(1)125A(3)	3.0	3										
125	5.6	C	T110C565(1)125A(3)	3.0	3										
125	6.8	C	T110C685(1)125A(3)	3.0	3										
125	8.2	D	T110D825(1)125A(3)	6.0	3										
125	10.0	D	T110D106(1)125A(3)	6.0	3										
VDC	µF	Case Size Code	(see below for part options)	µA @ 25°C Max/5 Minutes	120 Hz Maximum	M (1.0)	P (0.1)	R (0.01)	S (0.001)	G (1.0)	B (0.1)	C (0.01)	D (0.001)	Part Number	
Rated Voltage	Rated Cap	Case Size Code	KEMET Part Number	DC Leakage	DF % @ 25°C	MIL-PRF-39003 (CSR13) Capacitors									

- (1) To complete KEMET Part Number, insert M for ±20%, K for ±10%, or J for 5%. Designates capacitance tolerance.
- (2) To complete KEMET Part Number (T212), insert Graded failure rate - A for Not Applicable, B for .1%/k hours, C for .01%/k hours, D for .001%/k hours, or G for 1%/k hours; or insert Exponential failure rate - M for 1%/k hours, P for .1%/k hours, R for .01%/k hours, or S for .001%/k hours. Designates Reliability Level.
- (3) To complete KEMET Part Number (T110), insert Lead Material designator - S for Standard or T for 100% Matte Tin. Designates Termination finish.
- Refer to Ordering Information for additional detail.

Ripple Current/Ripple Voltage

Permissible AC ripple voltage is related to the ESR of the capacitor and the power dissipation capabilities of a particular case size. Thermal capacities for the various case sizes have been determined empirically and are listed below.

Temperature Compensation Multipliers for Maximum Power Dissipation		
T ≤ 25°C	T ≤ 85°C	T ≤ 125°C
1.00	0.90	0.40

T = Environmental Temperature

Case Size	Maximum Power Dissipation (P max)	T2XX
A	0.09	0.070
B	0.100	0.090
C	0.125	–
D	0.180	–

Permissible AC ripple current can be determined by the following:

$$I(max) = Z \sqrt{P_{max}/R}$$

P max = maximum watts

R = ESR at specified frequency (ohms)

I = rms ripple current (amperes)

Z = capacitor impedance in ohms at the specified frequency

Maximum Power Dissipation: 25°C Ambient

Optimum Solder Wave Profile

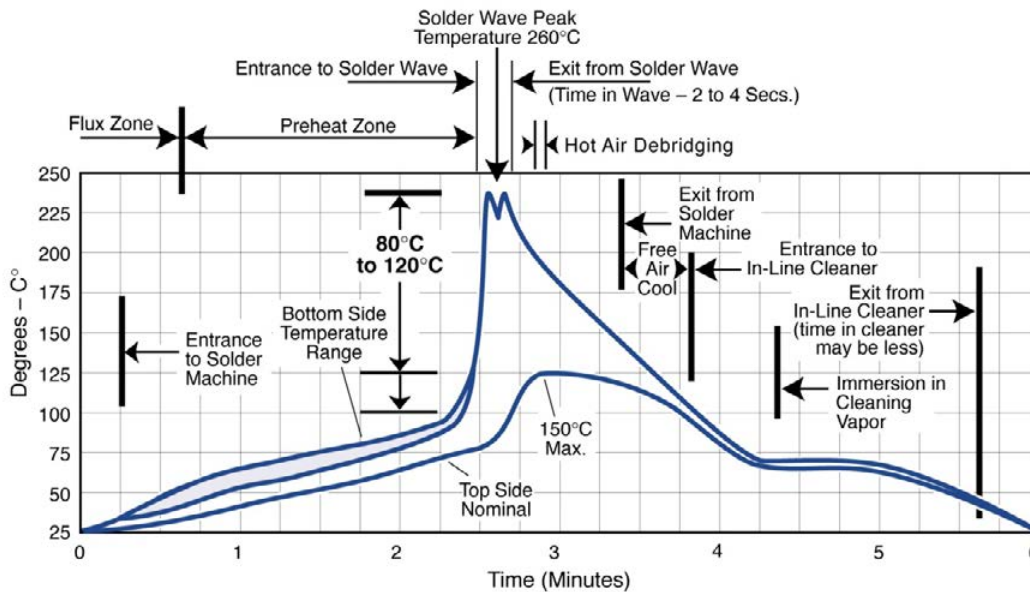

Reverse Voltage

Although these are polar capacitors, some degree of transient voltage reversal is permissible, as seen below. The capacitors should not be operated continuously in reverse mode, even within these limits.

Temperature	Percentage of Rated Voltage
+25°C	15
+85°C	5
+125°C	1

Mounting

All encased capacitors will pass the Resistance to Soldering Heat Test of MIL-STD-202, Method 210, Condition C. This test simulates wave solder of topside board mount product. This demonstration of resistance to solder heat is in accordance with what is believed to be the industry standard. More severe treatment must be considered reflective of an improper soldering process. The above figure is a recommended solder wave profile for both axial and radial leaded solid tantalum capacitors.

Capacitor Marking

T110

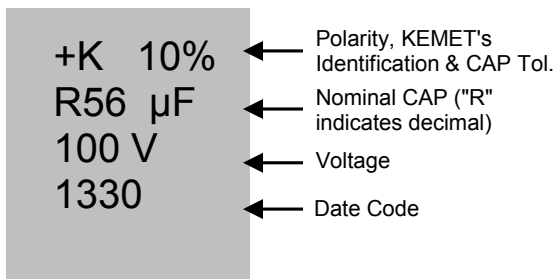

Date Code *	
1 st digit = Last number of Year	2 = 2012 3 = 2013 4 = 2014
2 nd and 3 rd digit = Week of the Year	01 = 1 st week of the Year to 52 = 52 nd week of the Year

T212

Case A

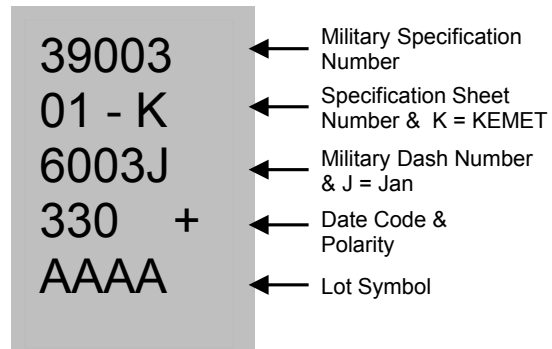

Case B

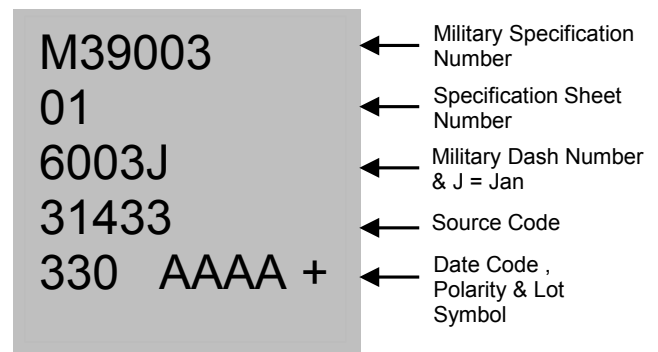

Storage

Tantalum hermetically sealed capacitors should be stored in normal working environments. While the capacitors themselves are quite robust in other environments, solderability will be degraded by exposure to high temperatures, high humidity, corrosive atmospheres, and long term storage. In addition, packaging materials will be degraded by high temperature— reels may soften or warp and tape peel force may increase. KEMET recommends that maximum storage temperature not exceed 40°C and maximum storage humidity not exceed 60% relative humidity. Temperature fluctuations should be minimized to avoid condensation on the parts and atmospheres should be free of chlorine and sulphur bearing compounds. For optimized solderability capacitors stock should be used promptly, preferably within three years of receipt.

Tape & Reel Packaging Information

KEMET offers standard reeling of Solid Tantalum Capacitors for automatic insertion or lead forming machines per EIA Specification RS-296E.

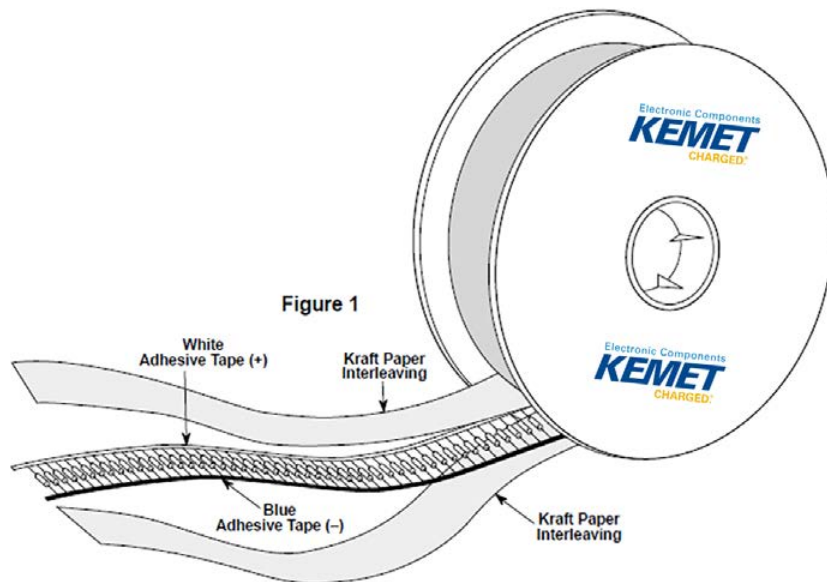

Table 2 – Packaging Quantity

Case Size	Standard Bulk Quantity	Standard Reel Quantity	Reel C-Spec	Ammo Pack Quantity	Ammo Pack C-Spec
A	150/Box	3,500	C-7200	1,500	C-7293
B	75/Box	2,500	C-7200	1,000	Class I
C	20/Tray	500	C-7200	250	C-7442
D	20/Tray	400	C-7200	250	Class II C-7443 Class III

Figure 2

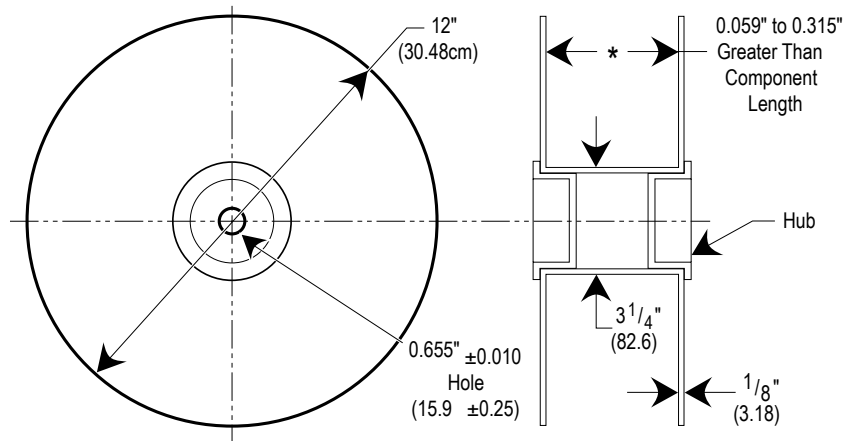

Figure 3

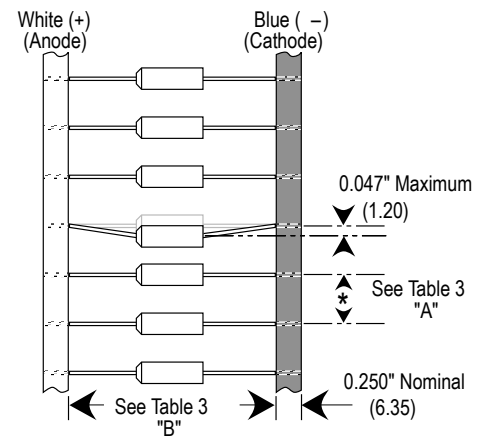

Table 3 – Tape Dimensions

Component Body Diameter	Component Pitch "A"	Inside Tape Spacing "B" ±1.5 mm (0.059")		
		I	II	III
0" (0 mm) to 0.197" (5 mm)	0.020" or (±0.5 mm)	2.062"	2.500"	2.874"
0.197" (5.01 mm) to 0.394" (10 mm)	0.400 or (10 mm)	(52.4 mm)	(63.5 mm)	(73 mm)

Capacitors are reeled so that positive leads are oriented as shown in Figure 3. Kraft paper (50lb. test minimum) is inserted between the layers of capacitors wound on reels for component pitch ≤ 0.200 " sizes and corrugated paper (70 lb. test minimum), single faced is inserted for component pitch ≥ 0.400 " sizes. Capacitor lead length may extend only a maximum of .031" (0.8 mm) beyond the tape's edges. Capacitors are centered in a row between the two tapes and will deviate only ± 0.031 " (0.79 mm) from the row center. Figures 1 and 2 show the KEMET standard chipboard tape reel. A minimum of 36" (91.5 cm) leader tape is provided at each end of the reeled capacitors. Universal splicing clips are used to connect the tape.

KEMET Corporation World Headquarters

2835 KEMET Way
Simpsonville, SC 29681

Mailing Address:
P.O. Box 5928
Greenville, SC 29606

www.kemet.com
Tel: 864-963-6300
Fax: 864-963-6521

Corporate Offices
Fort Lauderdale, FL
Tel: 954-766-2800

North America

Southeast
Lake Mary, FL
Tel: 407-855-8886

Northeast
Wilmington, MA
Tel: 978-658-1663

Central
Novi, MI
Tel: 248-306-9353

West
Milpitas, CA
Tel: 408-433-9950

Mexico
Guadalajara, Jalisco
Tel: 52-33-3123-2141

Europe

Southern Europe
Paris, France
Tel: 33-1-4646-1006

Sasso Marconi, Italy
Tel: 39-051-939111

Central Europe
Landsberg, Germany
Tel: 49-8191-3350800

Kamen, Germany
Tel: 49-2307-438110

Northern Europe
Bishop's Stortford, United Kingdom
Tel: 44-1279-460122

Espoo, Finland
Tel: 358-9-5406-5000

Asia

Northeast Asia
Hong Kong
Tel: 852-2305-1168

Shenzhen, China
Tel: 86-755-2518-1306

Beijing, China
Tel: 86-10-5829-1711

Shanghai, China
Tel: 86-21-6447-0707

Taipei, Taiwan
Tel: 886-2-27528585

Southeast Asia
Singapore
Tel: 65-6586-1900

Penang, Malaysia
Tel: 60-4-6430200

Bangalore, India
Tel: 91-806-53-76817

Note: KEMET reserves the right to modify minor details of internal and external construction at any time in the interest of product improvement. KEMET does not assume any responsibility for infringement that might result from the use of KEMET Capacitors in potential circuit designs. KEMET is a registered trademark of KEMET Electronics Corporation.

Other KEMET Resources

Tools	
Resource	Location
Configure A Part: CapEdge	http://capacitoredge.kemet.com
SPICE & FIT Software	http://www.kemet.com/spice
Search Our FAQs: KnowledgeEdge	http://www.kemet.com/keask
Electrolytic LifeCalculator	http://www.kemet.com:8080/elc

Product Information	
Resource	Location
Products	http://www.kemet.com/products
Technical Resources (Including Soldering Techniques)	http://www.kemet.com/technicalpapers
RoHS Statement	http://www.kemet.com/rohs
Quality Documents	http://www.kemet.com/qualitydocuments

Product Request	
Resource	Location
Sample Request	http://www.kemet.com/sample
Engineering Kit Request	http://www.kemet.com/kits

Contact	
Resource	Location
Website	www.kemet.com
Contact Us	http://www.kemet.com/contact
Investor Relations	http://www.kemet.com/ir
Call Us	1-877-MyKEMET
Twitter	http://twitter.com/kemetcapacitors

Disclaimer

All product specifications, statements, information and data (collectively, the "Information") in this datasheet are subject to change. The customer is responsible for checking and verifying the extent to which the Information contained in this publication is applicable to an order at the time the order is placed.

All Information given herein is believed to be accurate and reliable, but it is presented without guarantee, warranty, or responsibility of any kind, expressed or implied.

Statements of suitability for certain applications are based on KEMET Electronics Corporation's ("KEMET") knowledge of typical operating conditions for such applications, but are not intended to constitute – and KEMET specifically disclaims – any warranty concerning suitability for a specific customer application or use. The Information is intended for use only by customers who have the requisite experience and capability to determine the correct products for their application. Any technical advice inferred from this Information or otherwise provided by KEMET with reference to the use of KEMET's products is given gratis, and KEMET assumes no obligation or liability for the advice given or results obtained.

Although KEMET designs and manufactures its products to the most stringent quality and safety standards, given the current state of the art, isolated component failures may still occur. Accordingly, customer applications which require a high degree of reliability or safety should employ suitable designs or other safeguards (such as installation of protective circuitry or redundancies) in order to ensure that the failure of an electrical component does not result in a risk of personal injury or property damage.

Although all product-related warnings, cautions and notes must be observed, the customer should not assume that all safety measures are indicated or that other measures may not be required.