

P	LTR	DESCRIPTION	DATE	DWN	APVD
C3		REVISED ECR-11-021545	24OCT11		C.Z S.Y

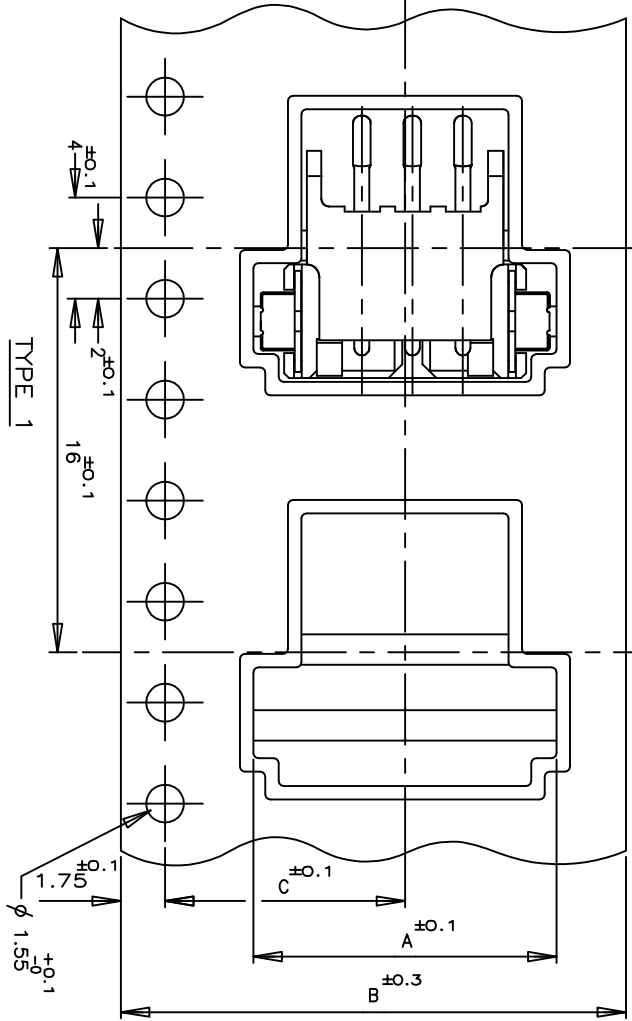

TOP OF REEL

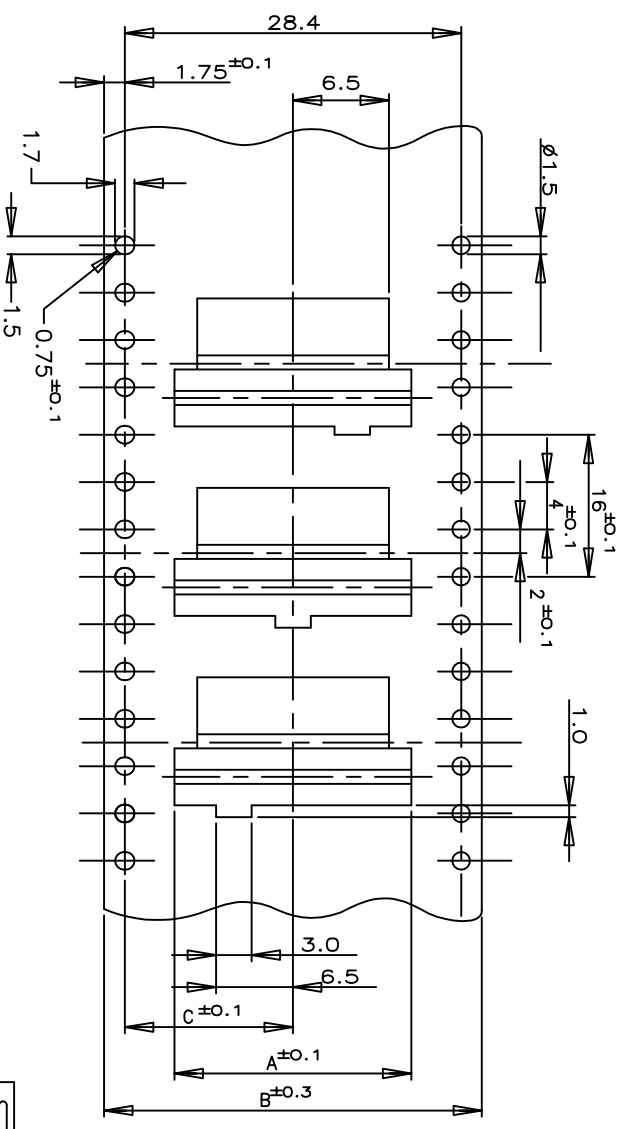
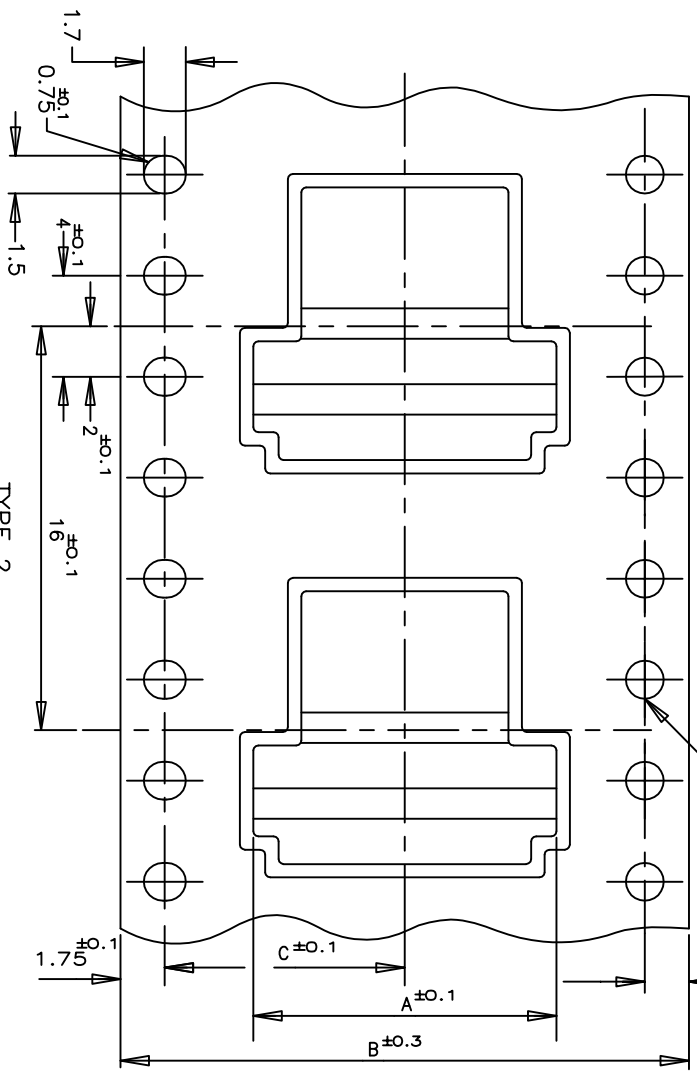
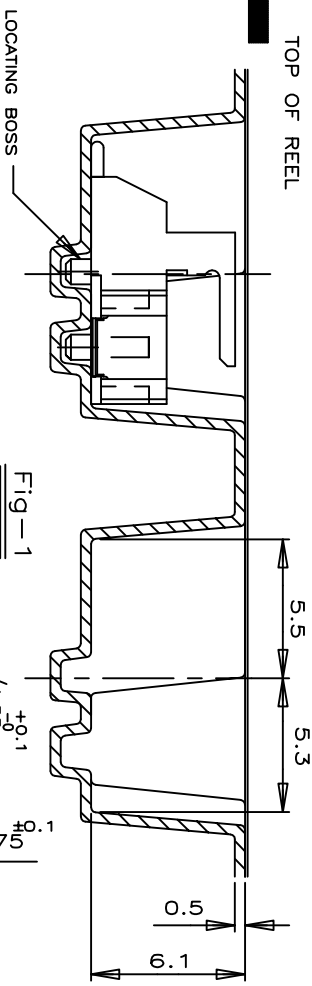

TYPE 3 FOR 7P ONLY
THREE KINDS OF DIFFERENT POCKETS AS 1 SET
USED FOR 7P ONLY

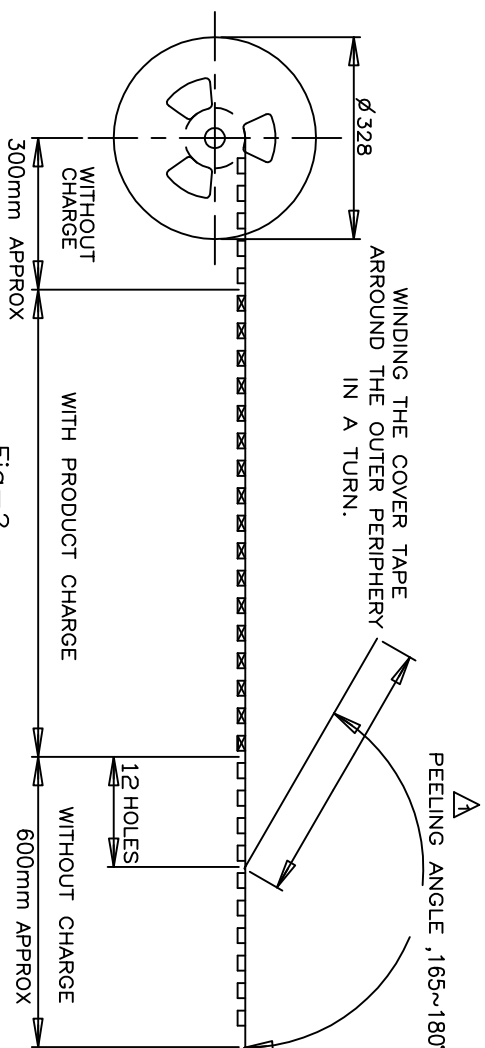
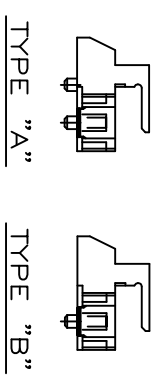

COLOR	BLACK		NATURAL		WITH	TAPING P/N					
	PLATE	TYPE	PLATE	TYPE							
A	11.5	TYPE 1	24	10	500	2	0-292173-2				
		TYPE 2					24	10	500	2	0-292173-2
		TYPE 3					24	10	500	2	0-292173-2
B	14.2	TYPE 1	32	18	500	2	0-292173-2				
		TYPE 2					32	18	500	2	0-292173-2
		TYPE 3					32	18	500	2	0-292173-2
C	14.2	TYPE 1	32	20	500	2	0-292173-2				
		TYPE 2					32	20	500	2	0-292173-2
		TYPE 3					32	20	500	2	0-292173-2



ON TAPING (EMBOSS)
TE CT CONNECTOR POST HEADER ASS'Y
(BOX-H SMT TYPE W/BOSS & TAIL)

THIS DRAWING IS A CONTROLLED DOCUMENT.		DIMENSIONS: MM		TOLERANCES UNLESS OTHERWISE SPECIFIED:	
DWN	JACK HOU	21SEP10		0 PLC	±
CHK	MARTIN LI	21SEP10		1 PLC	±
APVD	STEVEN YAO	21SEP10		2 PLC	±
				3 PLC	±
				4 PLC	±
				ANGLES	±
				FINISH	±

NAME	SIZE	WEIGHT	CUSTOMER DRAWING
TE CT CONNECTOR POST HEADER ASS'Y (BOX-H SMT TYPE W/BOSS & TAIL)	A3	00779	292173

TOLERANCE UNLESS OTHERWISE SPECIFIED:	ANGLE
10>±0.2	±3°
30>±0.25	
100>±0.3	

NOTES:
▲ PEELING RESISTANCE : 0.196N-0.686N (20gf-70gf)
SPEED : 300mm/min

Loc	DIST	REVISIONS		DATE	DWN	APVD
ES 00	00	P	DESCRIPTION			
		LTR	SEE SHEET 1			

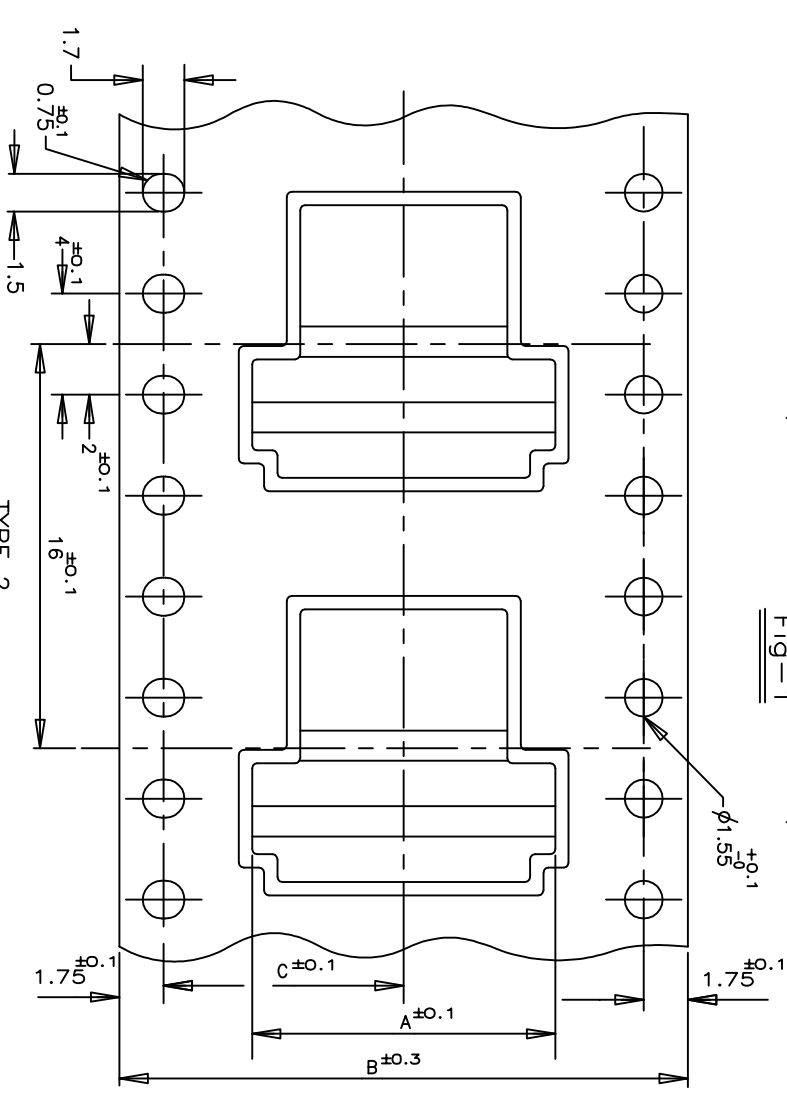
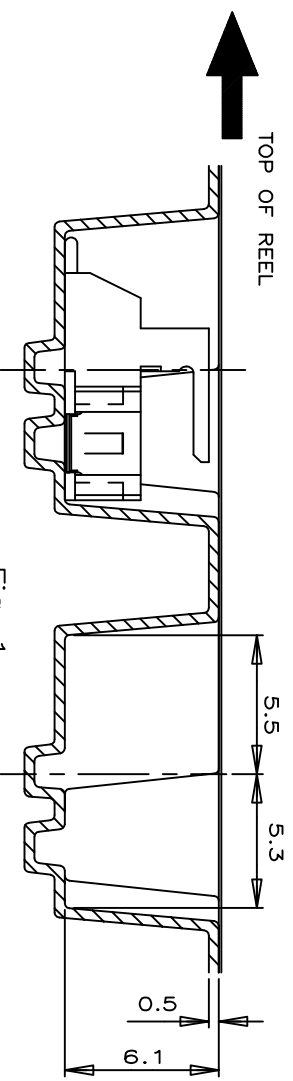
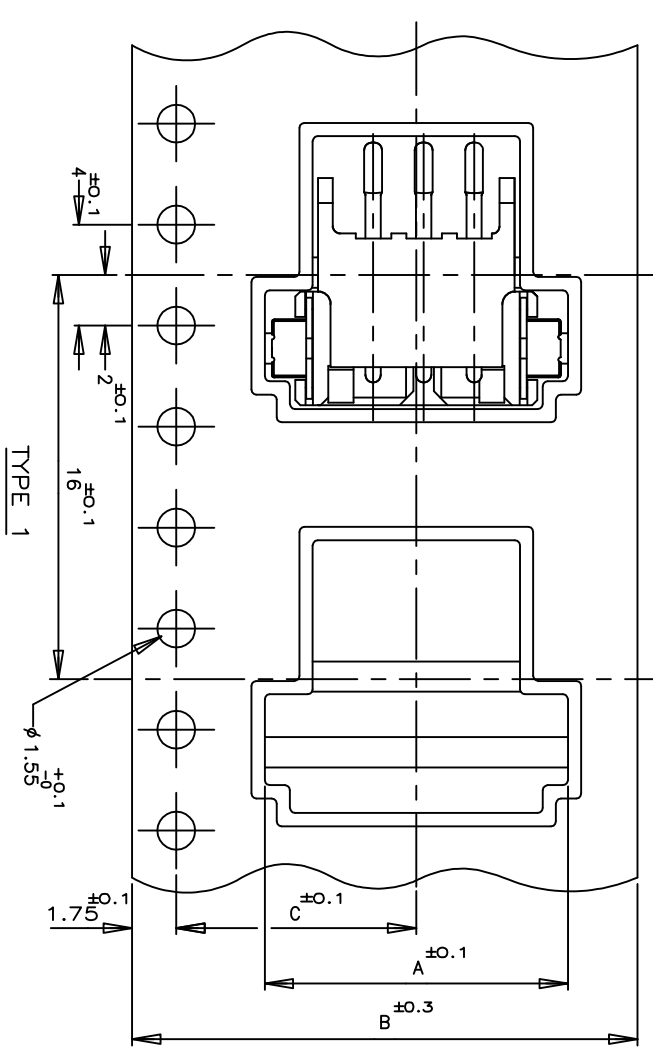

TOLERANCE UNLESS OTHERWISE SPECIFIED:

10>	±0.2
30>	±0.25
100>	±0.3
ANGLE	±.3°

NOTES:
 Δ PEELING RESISTANCE : 0.196N-0.686N (20gf-70gf)
 SPEED : 300mm/min

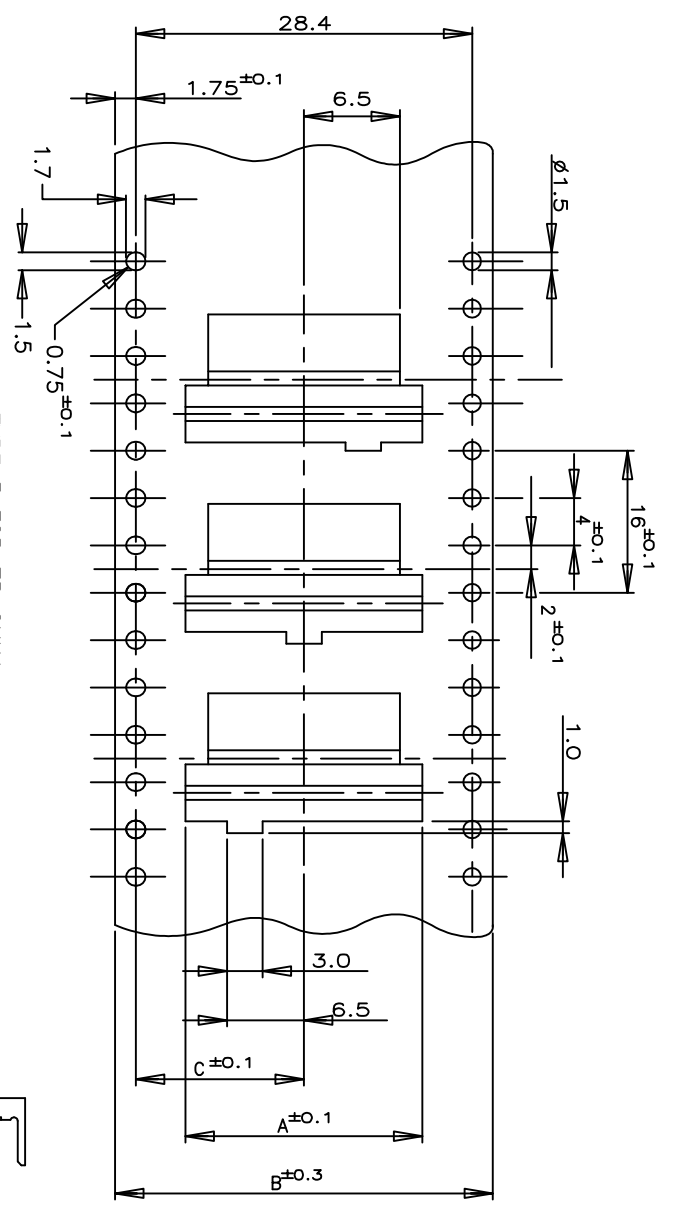

TYPE 3 FOR 7P ONLY
 THREE KINDS OF DIFFERENT POCKETS AS 1 SET
 USED FOR 7P ONLY

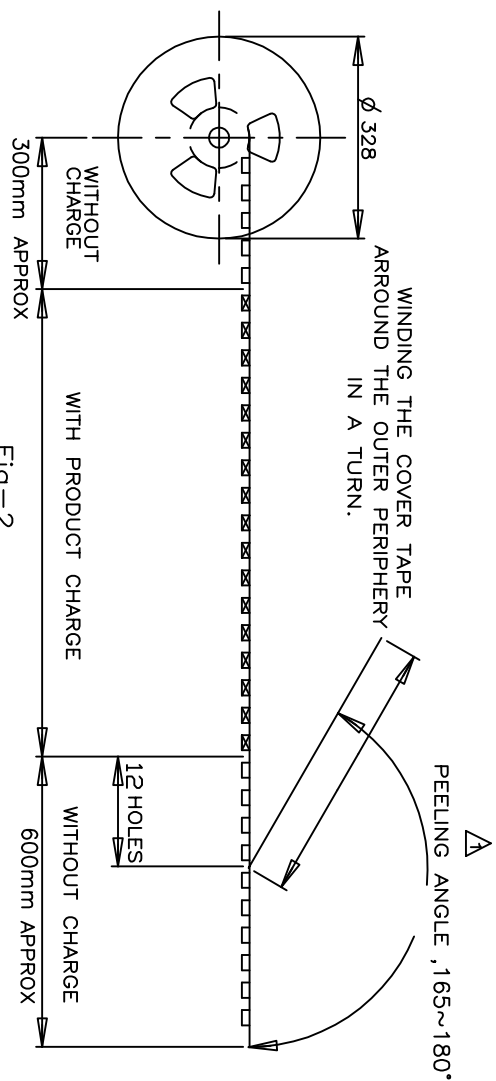
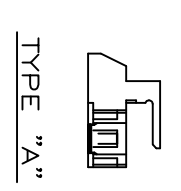

COLOR	WITH	TYPE	BLACK		NATURAL	
			PLATE	TYPE	PLATE	TYPE
BLACK	TYPE 2	A	20.2	44	24	500
	TYPE 3	A	20.2	44	22	500
	TYPE 2	A	14.2	32	18	500
	TYPE 2	A	11.5	24	16	500
	TYPE 1	A	11.5	24	14	500
	TYPE 1	A	11.5	24	12	500
	TYPE 2	A	20.2	44	24	500
	TYPE 2	A	20.2	44	22	500
	TYPE 3	A	14.2	32	20	500
	TYPE 2	A	14.2	32	18	500
	TYPE 2	A	11.5	24	16	500
	TYPE 2	A	11.5	24	14	500

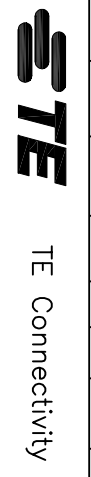

ON TAPING (EMBOSS)
 TE CT CONNECTOR POST HEADER ASS'Y
 (BOX-H SMT TYPE W/O BOSS & W/ TAIL)

DWN	CHK	APVD	NAME	SIZE	CAGE CODE	DRAWING NO	RESTRICTED TO
			TE CT CONNECTOR POST HEADER ASS'Y	A3	00779	292173	
DIMENSIONS: MM				SCALE			
TOLERANCES UNLESS OTHERWISE SPECIFIED:				SHEET 2 OF 6			
MATERIAL				REV C3			
FINISH				CUSTOMER DRAWING			

P	LTR	DESCRIPTION	DATE	DWN	APVD
-	-	SEE SHEET 1	-	-	-

REVISIONS		DATE	DWN	APVD

LAYOUT FOR 292173-X,1-292173-X

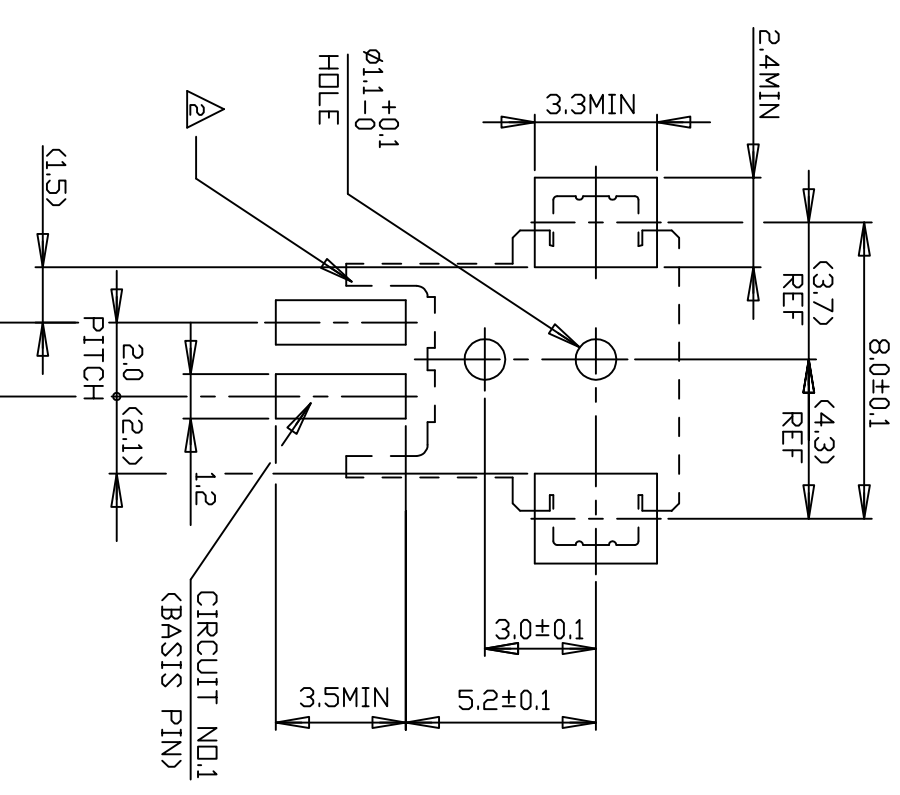
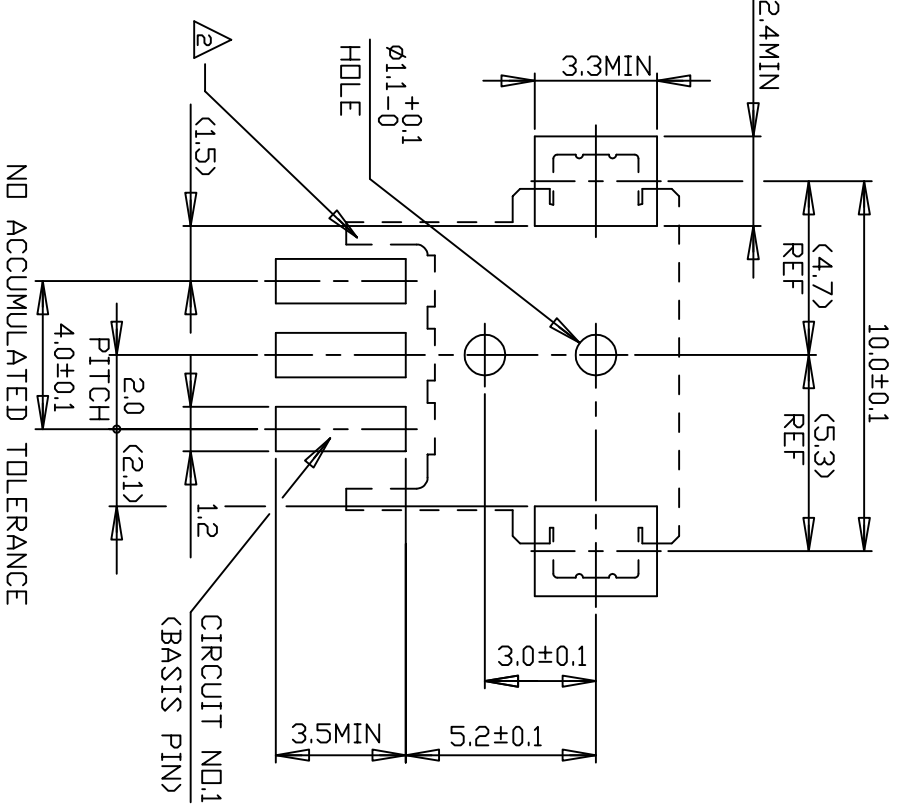
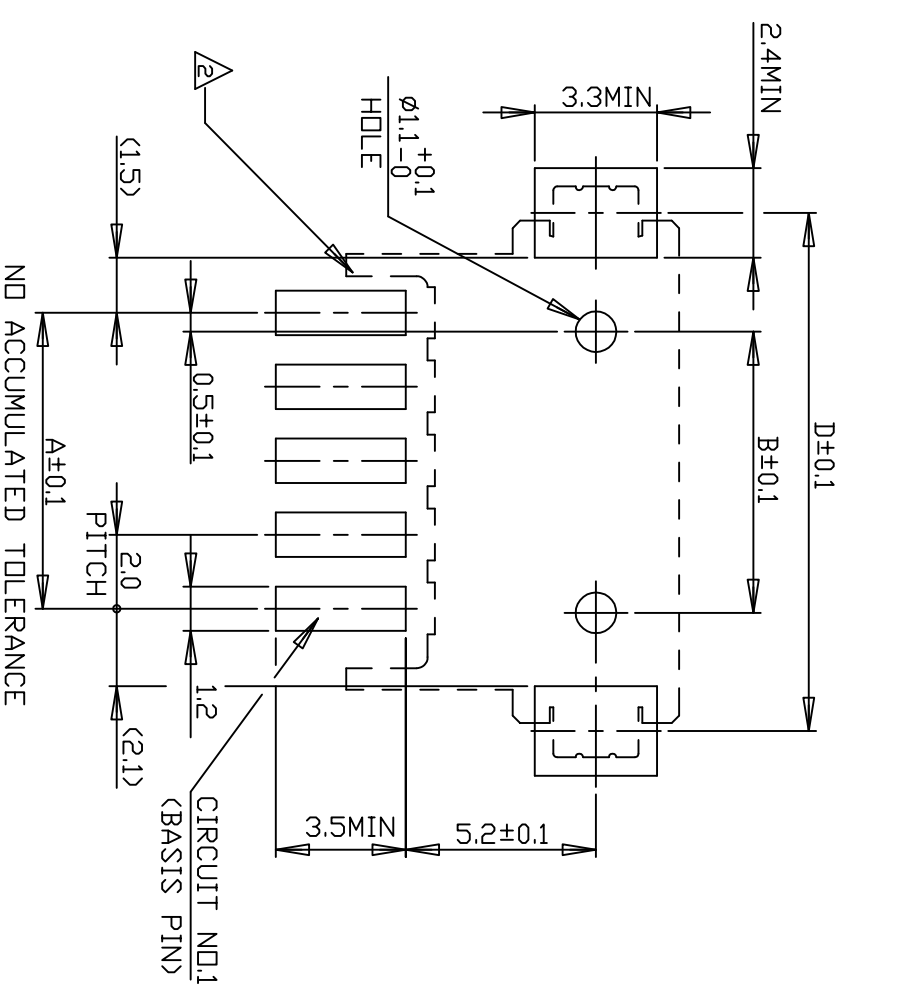

5 POS. & ABOVE POS.

3 POS.

2 POS.

RECOMMENDED P.C. BOARD LAYOUT
 (P.C.B THK:0.8mm MIN)

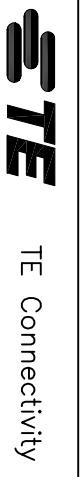

TE Connectivity

SMT TYPE POST HDR ASS'Y (H)
 WITH BOSS & TAIL TYPE
 (TE CT CONN. 2mm PITCH)

THIS DRAWING IS A CONTROLLED DOCUMENT.		DWN	-	NAME	SMT TYPE POST HDR ASS'Y (H) WITH BOSS & TAIL TYPE (TE CT CONN. 2mm PITCH)		
DIMENSIONS: MM		CHK	-	APVD	SIZE	CAGE CODE	DRAWING NO
TOLERANCES UNLESS OTHERWISE SPECIFIED:		APVD	-	PRODUCT SPEC	A3	00779	292173
0 PLC	±	PRODUCT SPEC	-	APPLICATION SPEC	SCALE	5:1	SHEET 4 OF 6
1 PLC	±	APPLICATION SPEC	-	WEIGHT	REV	C3	RESTRICTED TO
2 PLC	±	MATERIAL	-	CUSTOMER DRAWING			
3 PLC	±						
4. PRC	±						
ANGLES	±						
FINISH	±						

Loc	DIST	REVISIONS	DATE	DWN	APVD
ES	00				
P	LTR	DESCRIPTION			
-	-	SEE SHEET 1			

LAYOUT FOR 2-292173-X,3-2-292173-X

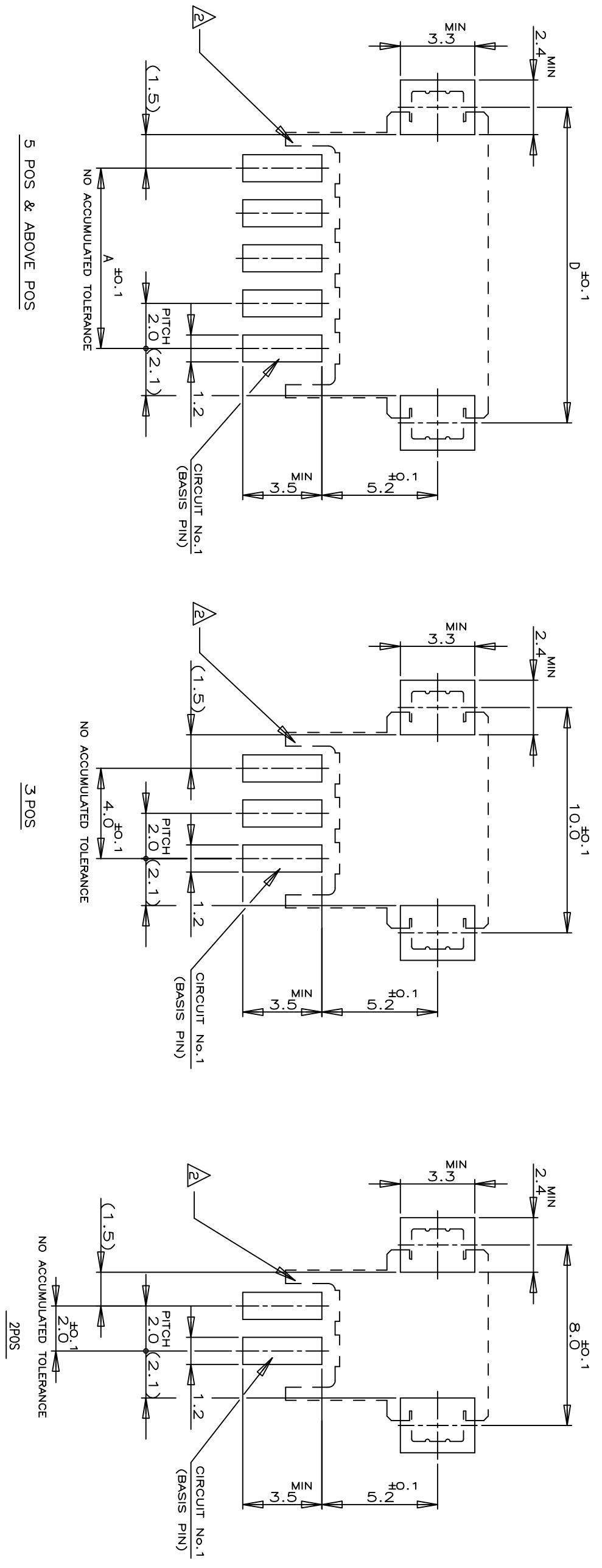

RECOMMENDED P.C.BOARD LAYOUT
(P.C.B THK:0.8mm MIN)

STE TE Connectivity

SMT TYPE POST HDR ASS'Y (H)
W/O, WITH TAIL TYPE
(TE CT CONN. 2mm PITCH)

DIMENSIONS:	MM	TOLERANCES UNLESS OTHERWISE SPECIFIED:
0 PLC	±	
1 PLC	±	
2 PLC	±	
3 PLC	±	
4 PLC	±	
ANGLES	±	
FINISH	±	

DWN	CHK	APVD	NAME
-	-	-	-
PRODUCT SPEC	APPLICATION SPEC	WEIGHT	CUSTOMER DRAWING
SIZE	CAGE CODE	DRAWING NO	RESTRICTED TO
A3	00779	292173	

SCALE 5:1 SHEET 6 OF 6 REV C3