

General Specifications

Electrical Capacity (Resistive Load)

Power Level (silver): 6A @ 125V AC & 3A @ 250V AC

4A @ 30V DC for On-None-On & On-None-Off; 3A @ 30V DC for all other circuits

Logic Level (gold): 0.4VA maximum @ 28V AC/DC maximum (Applicable Range 0.1mA ~ 0.1A @ 20mV ~ 28V)

Logic/Power Level (gold over silver): Combines silver & gold ratings

Note: Find additional explanation of dual rating & operating range in Supplement section.

Other Ratings

Contact Resistance: 10 milliohms maximum for silver; 20 milliohms maximum for gold

Insulation Resistance: 1,000 megohms minimum @ 500V DC

Dielectric Strength: 1,000V AC minimum between contacts for 1 minute minimum;
1,500V AC minimum between contacts and case for 1 minute minimum

Mechanical Life: 100,000 operations minimum; 50,000 operations minimum for flat, locking & splashproof devices

Electrical Life: 25,000 operations minimum for silver; 50,000 operations minimum for gold;

50,000 operations minimum for silver at 3A @ 125V AC

Angle of Throw: 25°

Materials & Finishes

Toggle: Brass with chrome plating

Frame: Stainless steel

Bushing: Brass with nickel plating

Support Bracket: Brass with tin plating

Case: Diallyl phthalate resin (UL94V-0)

Movable Contactor: Phosphor bronze with silver or gold plating

Movable Contacts: Silver alloy (code W); copper with gold plating (code G); or silver alloy with gold plating (code A)

Stationary Contacts: Silver with silver plating (code W); copper or brass with gold plating (code G);
or silver with gold plating (code A)

Terminals: Copper or brass with silver plating; or copper or brass with gold plating

Environmental Data

Operating Temp Range: -30°C through +85°C (-22°F through +185°F)

Humidity: 90 ~ 95% humidity for 96 hours @ 40°C (104°F)

Vibration: 10 ~ 55Hz with peak-to-peak amplitude of 1.5mm traversing the frequency range & returning
in 1 minute; 3 right angled directions for 2 hours

Shock: 50G (490m/s²) acceleration (tested in 6 right angled directions, with 5 shocks in each direction)

Sealing: Splashproof bushing options B3, D3, D8, L3, & L8, which have o-rings inside & outside the
bushing, meet IP67 of IEC60529 Standards.

Installation

Mounting Torque: 3.0Nm (26.55 lb•in) double nut for large bushing;

1.5Nm (13 lb•in) double nut & 0.7Nm (6 lb•in) single nut for all other bushings

Processing

Soldering: Wave Soldering (PC version) for Gold: See Profile A in Supplement section.

Manual Soldering for Gold: See Profile A in Supplement section.

Wave Soldering (PC version) for Silver: See Profile B in Supplement section.

Manual Soldering for Silver: See Profile B in Supplement section.

Note: Lever must be in OFF (center) position while soldering.

Cleaning: These devices are not process sealed. Hand clean locally using alcohol based solution.

Standards & Certifications

Flammability Standards: UL94V-0 for case

UL: File No. E44145 - Recognized only when ordered with marking on switch.

Add "/U" or "/CUL" before dash in part number to order UL recognized switch.

All models recognized at 6A @ 125V AC, 3A @ 250V AC or 0.4VA maximum @ 28V DC maximum.

CSA: File No. 023535_0_000 - Certified only when ordered with marking on switch.

Add "/C" before dash in part number to order CSA certified switch.

All models certified at 6A @ 125V AC or 3A @ 250V AC or 0.4VA maximum @ 28V maximum.

Distinctive Characteristics

Antirotation design, standard on noncylindrical levers, mates toggle and bushing; bottom of toggle has two flattened sides which fit into a complementary opening inside bushing.

Antijamming design protects contacts from damage due to excessive downward force on actuator.

High torque bushing construction prevents rotation or separation from frame during installation.

High insulating barriers increase isolation of circuits in multipole devices and provide added protection to contact points.

Molded diallyl phthalate case has a UL flammability rating of 94V-0.

Epoxy sealed terminals prevent entry of solder flux and other contaminants.

Prominent external insulating barriers increase insulation resistance and dielectric strength.

Interlocked actuator block, lever, and interior guide prevent switch failure due to biased lever movement.

Clinching of frame to case well above base and terminals provides 1,500V dielectric strength.

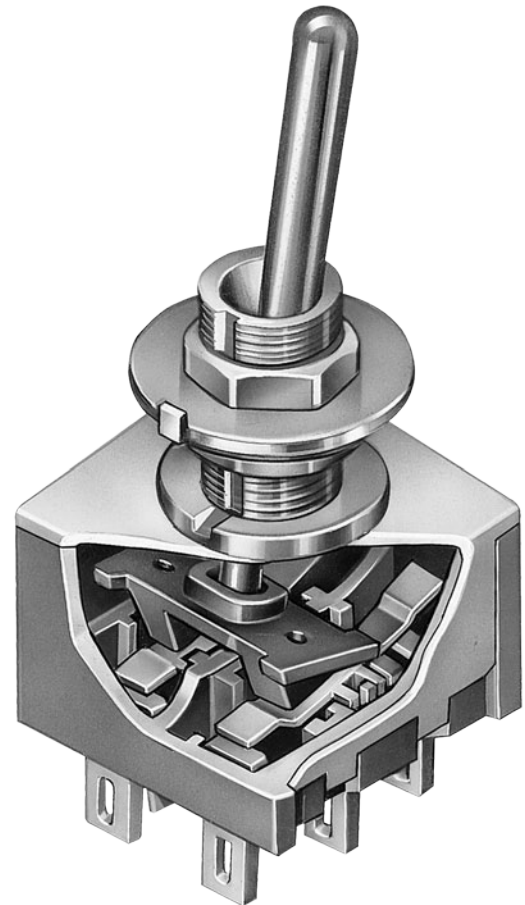

Actual Size

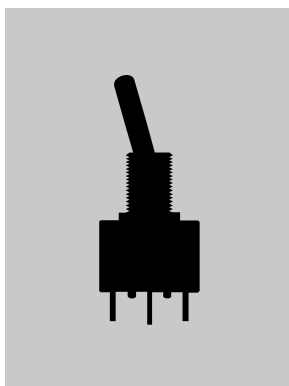

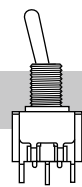
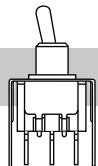
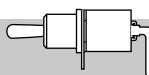
	Bushing Mount	Page A48
	Bracket PC Mount	Page A60
	Angle PC Mount	Page A66

A Toggles

Rockers

Pushbuttons

Illuminated PB

Programmable

Keylocks

Rotaries

Slides

Tactiles

Tilt

Touch

Indicators

Accessories

Supplement

TYPICAL SWITCH

ORDERING EXAMPLE

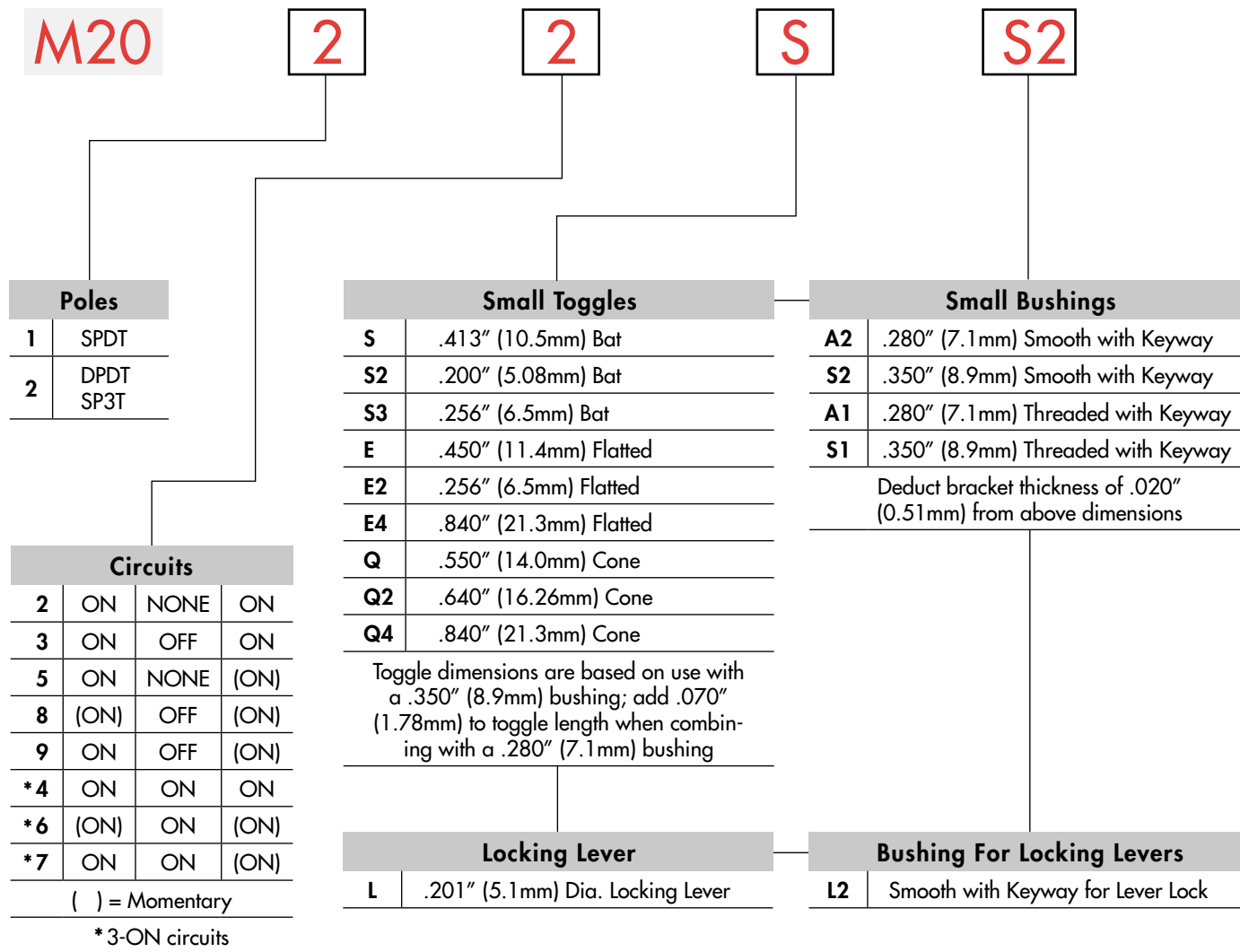

Standard Toggle & Bushing Combinations:
SS2 & S2A2

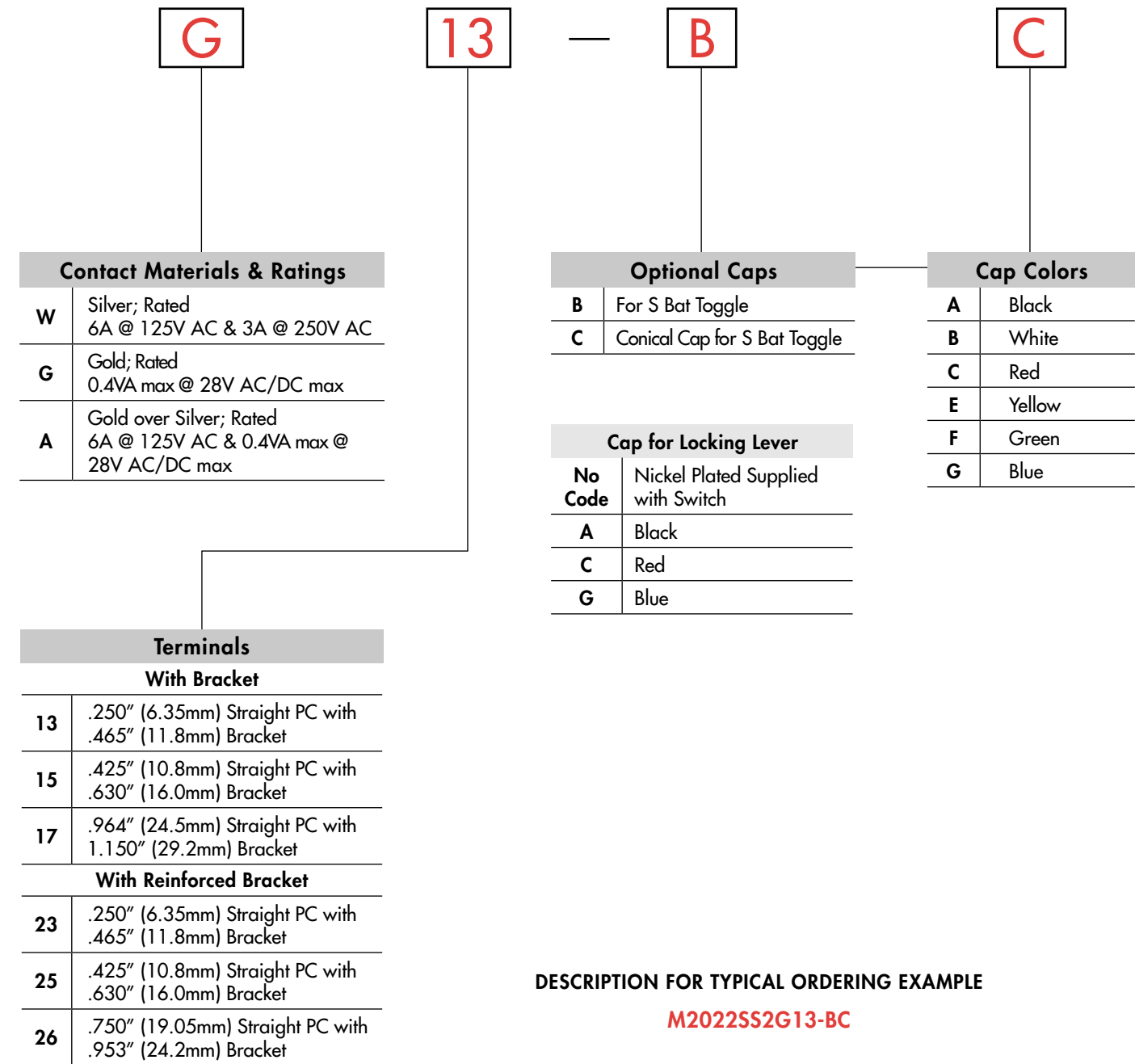

DESCRIPTION FOR TYPICAL ORDERING EXAMPLE

M2022SS2G13-BC

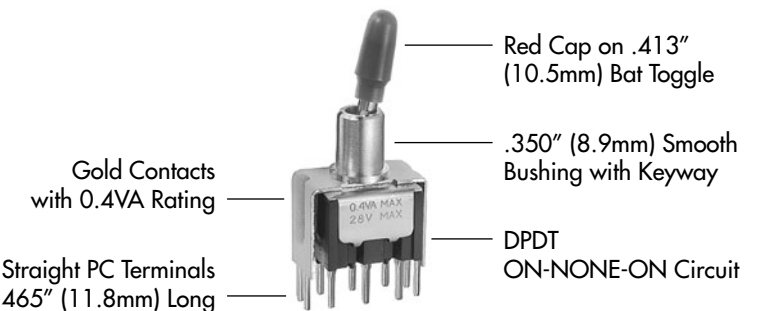

IMPORTANT:
Switches are supplied without UL, cULus & CSA marking unless specified. **UL, cULus & CSA recognized only when ordered with marking on the switch.** Specific models, ratings, & ordering instructions are noted on General Specifications page.

Toggles **A**

POLES & CIRCUITS

Pole	Model	Toggle Position () = Momentary			Connected Terminals			Throw & Schematics
		Down <small>Keyway</small>	Center	Up	Down <small>Keyway</small>	Center	Up	
SP	M2012 M2013 M2015 M2018 M2019	ON ON ON (ON) ON	NONE OFF NONE OFF OFF	ON ON (ON) (ON) (ON)	2-3	OPEN	2-1	SPDT
DP	M2022 M2023 M2025 M2028 M2029	ON ON ON (ON) ON	NONE OFF NONE OFF OFF	ON ON (ON) (ON) (ON)	2-3 5-6	OPEN	2-1 5-4	DPDT

For 3 Throw (3-On)

Pole	Model	Connected Terminals & Schematics			External Connection
		Down	Center	Up	
SP	M2024 M2026 M2027	ON (ON) ON 2-3 5-6	ON ON ON 2-3 5-4	ON (ON) (ON) 2-1 5-4	The SP3T model utilizes a double pole base. External connection must be made during field installation.

SMALL TOGGLES

Important:

Toggle length changes based on bushing selected. All illustrations are shown with .350" (8.9mm) long bushing. When using a .280" (7.1mm) long bushing, toggle length increases .070" (1.78mm).

Standard Material & Finish:

Brass with Bright Chrome
Contact factory for optional finishes.

S .413" (10.5mm) Bat

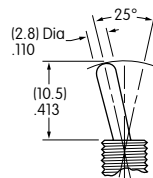

S2 .200" (5.08mm) Bat

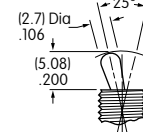

S3 .256" (6.5mm) Bat

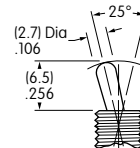

E .450" (11.4mm) Flatted

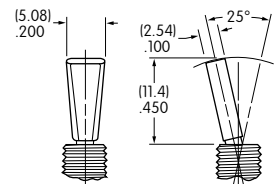

E2 .256" (6.5mm) Flatted

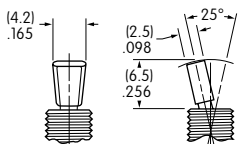

E4 .840" (21.3mm) Flatted

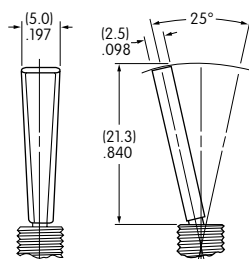

Q .550" (14.0mm) Cone

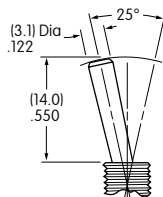

Q2 .640" (16.26mm) Cone

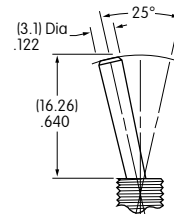

Q4 .840" (21.3mm) Cone

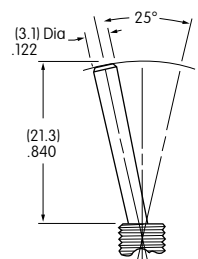

Rockers

Pushbuttons

Programmable Illuminated PB

Keylocks

Rotaries

Slides

Tactiles

Tilt

Touch

Indicators

Accessories

Supplement

SMALL BUSHINGS

A2 .280" (7.1mm)
Smooth with Keyway

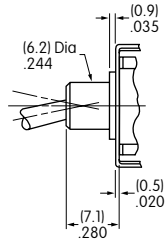
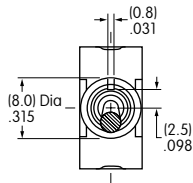

S2 .350" (8.9mm)
Smooth with Keyway

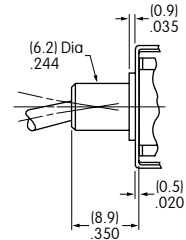
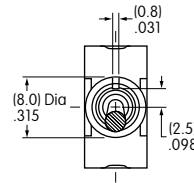

When using this bushing, toggle length is increased by .070" (1.78mm).

A1 .280" (7.1mm)
Threaded with Keyway

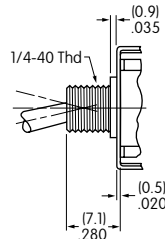
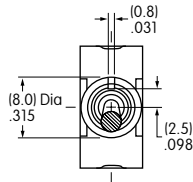

S1 .350" (8.9mm)
Threaded with Keyway

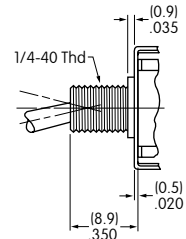
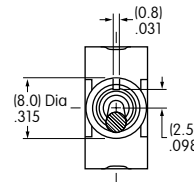

When using this bushing, toggle length is increased by .070" (1.78mm). Maximum Panel Thickness with Standard Hardware: .031" (0.8mm)

Maximum Panel Thickness with Standard Hardware: .102" (2.6mm)

Panel Cutouts

For A2, S2, A1, or S1 Bushing with Keyway

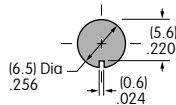

For A1 or S1 Bushing with Locking Ring

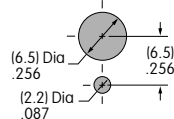

Standard Hardware:

- 2 Hex Nuts (AT513H)
- 1 Lockwasher (AT509)
- 1 Locking Ring (AT507H)

For dimensions, see Accessories & Hardware section.

LOCKING LEVER & BUSHING

LL2 Smooth with Keyway

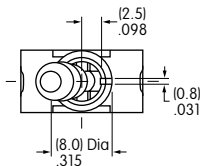

Locking Mechanism

on-none-on

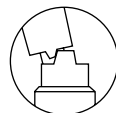

2 positions lock

on-none-(on)



1 position locks

on-off-(on)
on-on-(on)

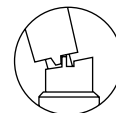

2 positions lock

on-off-on
on-on-on

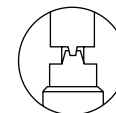

3 positions lock

(on)-off-(on)
(on)-on-(on)

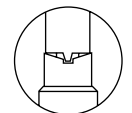

1 position locks

No Code

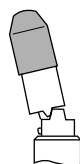

Cap for Locking Lever

Supplied with Cap AT427
Material & Finish:

Brass with Nickel Plating

Lever Material & Finish:

Brass with Chrome Plating

Color Codes for Optional Anodized Aluminum Caps

A Black

C Red

G Blue

Toggles **A**

Rockers

Pushbuttons

Illuminated PB

Programmable

Keylocks

Rotaries

Slides

Tactiles

Tilt

Touch

Indicators

Accessories

Supplement

CONTACT MATERIALS & RATINGS

W

Silver over Silver

Power Level

6A @ 125V AC & 3A @ 250V AC

G

Gold over Brass or Copper

Logic Level

0.4VA maximum @ 28V AC/DC maximum

Note: See Supplement section to find complete explanation of operating range.

A

Gold over Silver

Power Level
or Logic Level

6A @ 125V AC
or 0.4VA maximum @ 28V AC/DC maximum

Note: This dual rated option is suitable when two or more identical switches are used in logic and in power circuits within the same application. See Supplement section to find complete explanation of dual rating and operating range.

TERMINALS

Straight PC Mount with Bracket

Straight PC Mount with Reinforced Bracket

13

.250" (6.35mm)
Terminal with
.465" (11.8mm)
Bracket

15

.425" (10.8mm)
Terminal with
.630" (16.0mm)
Bracket

17

.964" (24.5mm)
Terminal with
1.150" (29.2mm)
Bracket

23

.250" (6.35mm)
Terminal with
.465" (11.8mm)
Bracket

25

.425" (10.8mm)
Terminal with
.630" (16.0mm)
Bracket

26

.750" (19.05mm)
Terminal with
.953" (24.2mm)
Bracket

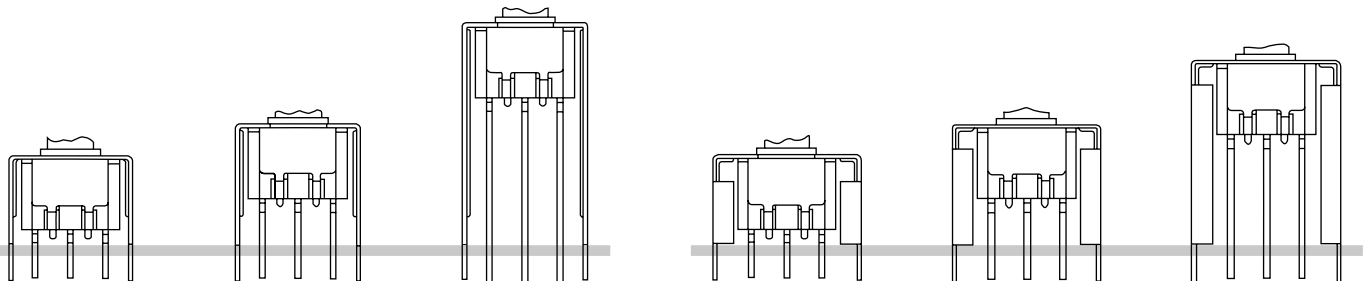

PCB footprints are on the following Typical Switch Dimension page.

OPTIONAL CAPS & CAP COLORS

B

AT415
for S Bat Toggle

Material:
Polyethylene

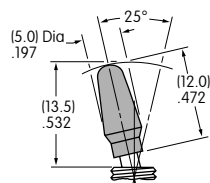

C

AT444
Conical Cap for
S Bat Toggle

Material:
Polyethylene

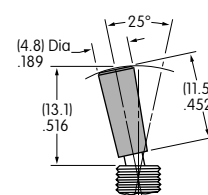

Cap Colors
Available:

A

Black

B

White

C

Red

E

Yellow

F

Green

G

Blue

TYPICAL SWITCH DIMENSIONS

Straight PC • Bracket

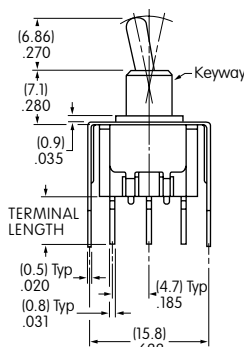
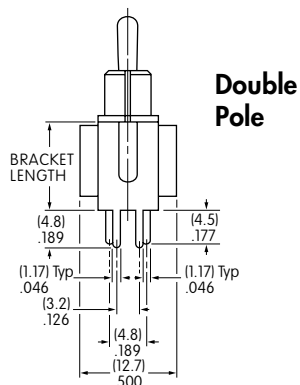
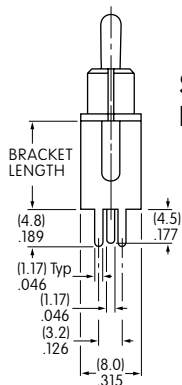

M2012S2A2G13

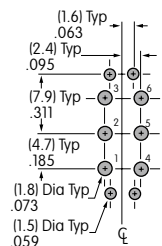
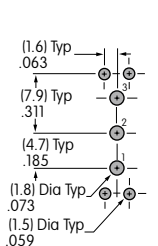

Terminal Code:	Terminal Length:	Bracket Length:
13	.250" (6.35mm)	.465" (11.8mm)
15	.425" (10.8mm)	.630" (16.0mm)
17	.964" (24.5mm)	1.150" (29.2mm)

Straight PC • Reinforced Bracket

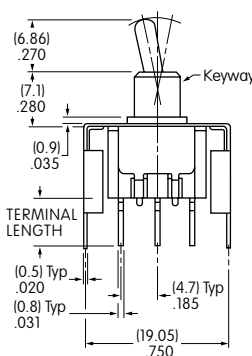
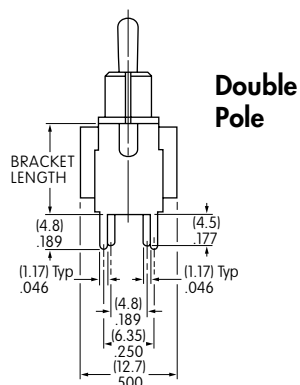
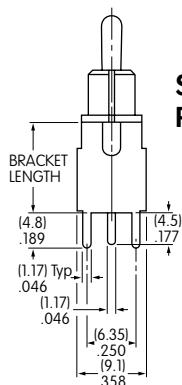

M2012S2A2G23

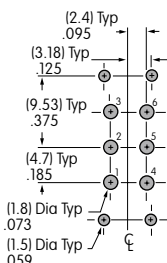
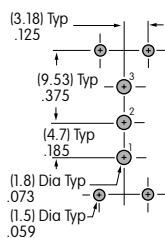

Terminal Code:	Terminal Length:	Bracket Length:
23	.250" (6.35mm)	.465" (11.8mm)
25	.425" (10.8mm)	.630" (16.0mm)
26	.750" (19.05mm)	.953" (24.2mm)