

# CAT24C01, CAT24C02, CAT24C04, CAT24C08, CAT24C16

## 1-Kb, 2-Kb, 4-Kb, 8-Kb and 16-Kb I<sup>2</sup>C CMOS Serial EEPROM

### Description

The CAT24C01/02/04/08/16 are 1-Kb, 2-Kb, 4-Kb, 8-Kb and 16-Kb respectively CMOS Serial EEPROM devices organized internally as 8/16/32/64 and 128 pages respectively of 16 bytes each. All devices support both the Standard (100 kHz) as well as Fast (400 kHz) I<sup>2</sup>C protocol.

Data is written by providing a starting address, then loading 1 to 16 contiguous bytes into a Page Write Buffer, and then writing all data to non-volatile memory in one internal write cycle. Data is read by providing a starting address and then shifting out data serially while automatically incrementing the internal address count.

External address pins make it possible to address up to eight CAT24C01 or CAT24C02, four CAT24C04, two CAT24C08 and one CAT24C16 device on the same bus.

### Features

- Supports Standard and Fast I<sup>2</sup>C Protocol
- 1.7 V to 5.5 V Supply Voltage Range
- 16-Byte Page Write Buffer
- Hardware Write Protection for Entire Memory
- Schmitt Triggers and Noise Suppression Filters on I<sup>2</sup>C Bus Inputs (SCL and SDA)
- Low power CMOS Technology
- More than 1,000,000 Program/Erase Cycles
- 100 Year Data Retention
- Industrial and Extended Temperature Range
- These Devices are Pb-Free, Halogen Free/BFR Free and are RoHS Compliant

### PIN CONFIGURATION

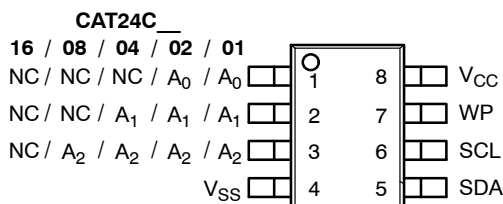

PDIP (L), SOIC (W), TSSOP (Y), MSOP (Z),  
TDFN, (VP2)\*, UDFN-EP (HU4) (Top View)

\* The TDFN (VP2) package is not recommended for new designs.

### ORDERING INFORMATION

See detailed ordering and shipping information in the package dimensions section on page 19 of this data sheet.



ON Semiconductor®

<http://onsemi.com>

	PDIP-8 L SUFFIX CASE 646AA		UDFN8-EP HU4 SUFFIX CASE 517AZ
	MSOP-8 Z SUFFIX CASE 846AD		TSOT-23 TD SUFFIX CASE 419AE
	TSSOP-8 Y SUFFIX CASE 948AL		TSOP-5** TS SUFFIX CASE 483
	SOIC-8 W SUFFIX CASE 751BD		WLCSP-4*** C4A SUFFIX CASE 567DC
	TDFN-8* VP2 SUFFIX CASE 511AK		WLCSP-5*** C5A SUFFIX CASE 567DD

### PIN CONFIGURATIONS

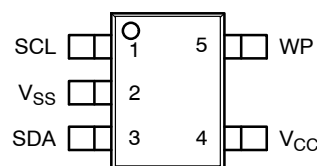

TSOT-23 (TD), TSOP-5\*\* (TS) (Top View)

\*\* TSOP are available for the CAT24C02 only.

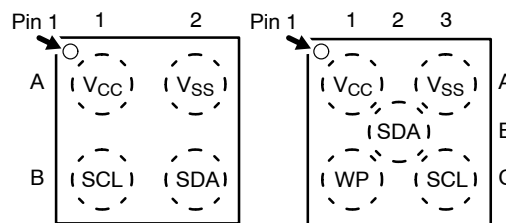

WLCSP-4\*\*\*  
WLCSP-5\*\*\*  
(Top Views)

\*\*\* WLCSP are available for the CAT24C04,  
CAT24C08 and CAT24C16 only.

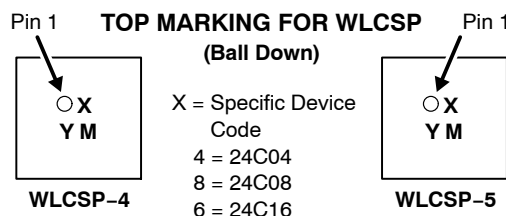

X = Specific Device Code  
4 = 24C04  
8 = 24C08  
6 = 24C16  
Y = Production Year (Last Digit)  
M = Production Month (1-9, O, N, D)

# CAT24C01, CAT24C02, CAT24C04, CAT24C08, CAT24C16

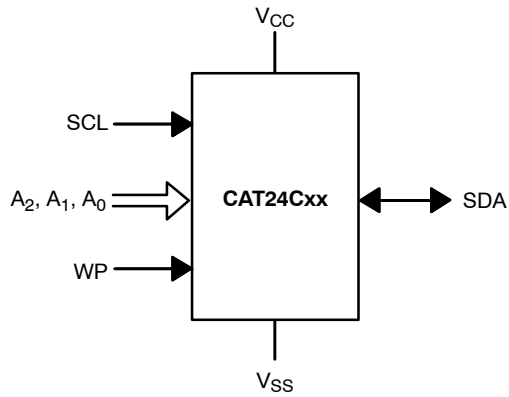

Figure 1. Functional Symbol

Table 1. PIN FUNCTION

Pin Name†	Function
A0, A1, A2	Device Address Input
SDA	Serial Data Input/Output
SCL	Serial Clock Input
WP	Write Protect Input
V <sub>CC</sub>	Power Supply
V <sub>SS</sub>	Ground
NC	No Connect

† The exposed pad for the TDFN/UDFN packages can be left floating or connected to Ground.

Table 2. ABSOLUTE MAXIMUM RATINGS

Parameters	Ratings	Units
Storage Temperature	-65 to +150	°C
Voltage on any pin with respect to Ground (Note 1)	-0.5 to +6.5	V

Stresses exceeding Maximum Ratings may damage the device. Maximum Ratings are stress ratings only. Functional operation above the Recommended Operating Conditions is not implied. Extended exposure to stresses above the Recommended Operating Conditions may affect device reliability.

1. During input transitions, voltage undershoot on any pin should not exceed -1 V for more than 20 ns. Voltage overshoot on pins A<sub>0</sub>, A<sub>1</sub>, A<sub>2</sub> and WP should not exceed V<sub>CC</sub> + 1 V for more than 20 ns, while voltage on the I<sup>2</sup>C bus pins, SCL and SDA, should not exceed the absolute maximum ratings, irrespective of V<sub>CC</sub>.

Table 3. RELIABILITY CHARACTERISTICS (Note 2)

Symbol	Parameter	Min	Units
N <sub>END</sub> (Note 3)	Endurance	1,000,000	Program / Erase Cycles
T <sub>DR</sub>	Data Retention	100	Years

2. These parameters are tested initially and after a design or process change that affects the parameter according to appropriate AEC-Q100 and JEDEC test methods.
3. Page Mode, V<sub>CC</sub> = 5 V, 25°C.

Table 4. D.C. OPERATING CHARACTERISTICS

(V<sub>CC</sub> = 1.8 V to 5.5 V, T<sub>A</sub> = -40°C to +125°C and V<sub>CC</sub> = 1.7 V to 5.5 V, T<sub>A</sub> = -40°C to +85°C, unless otherwise specified.)

Symbol	Parameter	Test Conditions		Min	Max	Units
I <sub>CCR</sub>	Read Current	Read, f <sub>SCL</sub> = 400 kHz			1	mA
I <sub>CCW</sub>	Write Current	Write, f <sub>SCL</sub> = 400 kHz			2	mA
I <sub>SB</sub>	Standby Current	All I/O Pins at GND or V <sub>CC</sub>	T <sub>A</sub> = -40°C to +85°C V <sub>CC</sub> ≤ 3.3 V		1	μA
			T <sub>A</sub> = -40°C to +85°C V <sub>CC</sub> > 3.3 V		3	
			T <sub>A</sub> = -40°C to +125°C		5	
I <sub>L</sub>	I/O Pin Leakage	Pin at GND or V <sub>CC</sub>			2	μA
V <sub>IL</sub>	Input Low Voltage			-0.5	0.3 x V <sub>CC</sub>	V
V <sub>IH</sub>	Input High Voltage	A <sub>0</sub> , A <sub>1</sub> , A <sub>2</sub> and WP		0.7 x V <sub>CC</sub>	V <sub>CC</sub> + 0.5	V
		SCL and SDA		0.7 x V <sub>CC</sub>	5.5	
V <sub>OL</sub>	Output Low Voltage	V <sub>CC</sub> > 2.5 V, I <sub>OL</sub> = 3 mA			0.4	
		V <sub>CC</sub> < 2.5 V, I <sub>OL</sub> = 1 mA			0.2	

# CAT24C01, CAT24C02, CAT24C04, CAT24C08, CAT24C16

**Table 5. PIN IMPEDANCE CHARACTERISTICS**

( $V_{CC} = 1.8\text{ V to }5.5\text{ V}$ ,  $T_A = -40^\circ\text{C to }+125^\circ\text{C}$  and  $V_{CC} = 1.7\text{ V to }5.5\text{ V}$ ,  $T_A = -40^\circ\text{C to }+85^\circ\text{C}$ , unless otherwise specified.)

Symbol	Parameter	Conditions	Max	Units
$C_{IN}$ (Note 4)	SDA Pin Capacitance	$V_{IN} = 0\text{ V}$ , $f = 1.0\text{ MHz}$ , $V_{CC} = 5.0\text{ V}$	8	pF
	Other Pins		6	pF
$I_{WP}$ (Note 5)	WP Input Current	$V_{IN} < V_{IH}$ , $V_{CC} = 5.5\text{ V}$	130	$\mu\text{A}$
		$V_{IN} < V_{IH}$ , $V_{CC} = 3.3\text{ V}$	120	
		$V_{IN} < V_{IH}$ , $V_{CC} = 1.7\text{ V}$	80	
		$V_{IN} > V_{IH}$	2	
$I_A$ (Note 5)	Address Input Current (A0, A1, A2) Product Rev H: CAT24C02 Product Rev K: CAT24C04, CAT24C08, CAT24C16	$V_{IN} < V_{IH}$ , $V_{CC} = 5.5\text{ V}$	50	$\mu\text{A}$
		$V_{IN} < V_{IH}$ , $V_{CC} = 3.3\text{ V}$	35	
		$V_{IN} < V_{IH}$ , $V_{CC} = 1.7\text{ V}$	25	
		$V_{IN} > V_{IH}$	2	

- These parameters are tested initially and after a design or process change that affects the parameter according to appropriate AEC-Q100 and JEDEC test methods.
- When not driven, the WP, A0, A1 and A2 pins are pulled down to GND internally. For improved noise immunity, the internal pull-down is relatively strong; therefore the external driver must be able to supply the pull-down current when attempting to drive the input HIGH. To conserve power, as the input level exceeds the trip point of the CMOS input buffer ( $\sim 0.5 \times V_{CC}$ ), the strong pull-down reverts to a weak current source.

**Table 6. A.C. CHARACTERISTICS**

(Note 6) ( $V_{CC} = 1.8\text{ V to }5.5\text{ V}$ ,  $T_A = -40^\circ\text{C to }+125^\circ\text{C}$  and  $V_{CC} = 1.7\text{ V to }5.5\text{ V}$ ,  $T_A = -40^\circ\text{C to }+85^\circ\text{C}$ , unless otherwise specified.)

Symbol	Parameter	Standard		Fast		Units
		Min	Max	Min	Max	
$F_{SCL}$	Clock Frequency		100		400	kHz
$t_{HD:STA}$	START Condition Hold Time	4		0.6		$\mu\text{s}$
$t_{LOW}$	Low Period of SCL Clock	4.7		1.3		$\mu\text{s}$
$t_{HIGH}$	High Period of SCL Clock	4		0.6		$\mu\text{s}$
$t_{SU:STA}$	START Condition Setup Time	4.7		0.6		$\mu\text{s}$
$t_{HD:DAT}$	Data In Hold Time	0		0		$\mu\text{s}$
$t_{SU:DAT}$	Data In Setup Time	250		100		ns
$t_R$	SDA and SCL Rise Time		1000		300	ns
$t_F$ (Note 6)	SDA and SCL Fall Time		300		300	ns
$t_{SU:STO}$	STOP Condition Setup Time	4		0.6		$\mu\text{s}$
$t_{BUF}$	Bus Free Time Between STOP and START	4.7		1.3		$\mu\text{s}$
$t_{AA}$	SCL Low to Data Out Valid		3.5		0.9	$\mu\text{s}$
$t_{DH}$	Data Out Hold Time	100		100		ns
$T_i$ (Note 6)	Noise Pulse Filtered at SCL and SDA Inputs		100		100	ns
$t_{SU:WP}$	WP Setup Time	0		0		$\mu\text{s}$
$t_{HD:WP}$	WP Hold Time	2.5		2.5		$\mu\text{s}$
$t_{WR}$	Write Cycle Time		5		5	ms
$t_{PU}$ (Notes 7, 8)	Power-up to Ready Mode		1		1	ms

- Test conditions according to "AC Test Conditions" table.
- Tested initially and after a design or process change that affects this parameter.
- $t_{PU}$  is the delay between the time  $V_{CC}$  is stable and the device is ready to accept commands.

**Table 7. A.C. TEST CONDITIONS**

Input Drive Levels	0.2 x V <sub>CC</sub> to 0.8 x V <sub>CC</sub>
Input Rise and Fall Time	≤ 50 ns
Input Reference Levels	0.3 x V <sub>CC</sub> , 0.7 x V <sub>CC</sub>
Output Reference Level	0.5 x V <sub>CC</sub>
Output Test Load	Current Source I <sub>OL</sub> = 3 mA (V <sub>CC</sub> ≥ 2.5 V); I <sub>OL</sub> = 1 mA (V <sub>CC</sub> < 2.5 V); C <sub>L</sub> = 100 pF

**Power-On Reset (POR)**

Each CAT24Cxx\* incorporates Power-On Reset (POR) circuitry which protects the internal logic against powering up in the wrong state.

A CAT24Cxx device will power up into Standby mode after V<sub>CC</sub> exceeds the POR trigger level and will power down into Reset mode when V<sub>CC</sub> drops below the POR trigger level. This bi-directional POR feature protects the device against ‘brown-out’ failure following a temporary loss of power.

*\*For common features, the CAT24C01/02/04/08/16 will be referred to as CAT24Cxx.*

**Pin Description**

**SCL:** The Serial Clock input pin accepts the Serial Clock generated by the Master.

**SDA:** The Serial Data I/O pin receives input data and transmits data stored in EEPROM. In transmit mode, this pin is open drain. Data is acquired on the positive edge, and is delivered on the negative edge of SCL.

**A0, A1 and A2:** The Address inputs set the device address when cascading multiple devices. When not driven, these pins are pulled LOW internally.

**WP:** The Write Protect input pin inhibits all write operations, when pulled HIGH. When not driven, this pin is pulled LOW internally.

**Functional Description**

The CAT24Cxx supports the Inter-Integrated Circuit (I<sup>2</sup>C) Bus data transmission protocol, which defines a device that sends data to the bus as a transmitter and a device receiving data as a receiver. Data flow is controlled by a Master device, which generates the serial clock and all START and STOP conditions. The CAT24Cxx acts as a Slave device. Master and Slave alternate as either transmitter or receiver.

**I<sup>2</sup>C Bus Protocol**

The I<sup>2</sup>C bus consists of two ‘wires’, SCL and SDA. The two wires are connected to the V<sub>CC</sub> supply via pull-up resistors. Master and Slave devices connect to the 2-wire bus via their respective SCL and SDA pins. The transmitting device pulls down the SDA line to ‘transmit’ a ‘0’ and releases it to ‘transmit’ a ‘1’.

Data transfer may be initiated only when the bus is not busy (see AC Characteristics).

During data transfer, the SDA line must remain stable while the SCL line is high. An SDA transition while SCL is high will be interpreted as a START or STOP condition (Figure 2). The START condition precedes all commands. It consists of a HIGH to LOW transition on SDA while SCL is HIGH. The START acts as a ‘wake-up’ call to all receivers. Absent a START, a Slave will not respond to commands. The STOP condition completes all commands. It consists of a LOW to HIGH transition on SDA while SCL is HIGH.

*NOTE: The I/O pins of CAT24Cxx do not obstruct the SCL and SDA lines if the VCC supply is switched off. During power-up, the SCL and SDA pins (connected with pull-up resistors to VCC) will follow the VCC monotonically from VSS (0 V) to nominal VCC value, regardless of pull-up resistor value. The delta between the VCC and the instantaneous voltage levels during power ramping will be determined by the relation between bus time constant (determined by pull-up resistance and bus capacitance) and actual VCC ramp rate.*

**Device Addressing**

The Master initiates data transfer by creating a START condition on the bus. The Master then broadcasts an 8-bit serial Slave address. For normal Read/Write operations, the first 4 bits of the Slave address are fixed at 1010 (Ah). The next 3 bits are used as programmable address bits when cascading multiple devices and/or as internal address bits. The last bit of the slave address, R/W, specifies whether a Read (1) or Write (0) operation is to be performed. The 3 address space extension bits are assigned as illustrated in Figure 3. A<sub>2</sub>, A<sub>1</sub> and A<sub>0</sub> must match the state of the external address pins, and a<sub>10</sub>, a<sub>9</sub> and a<sub>8</sub> are internal address bits.

**Acknowledge**

After processing the Slave address, the Slave responds with an acknowledge (ACK) by pulling down the SDA line during the 9th clock cycle (Figure 4). The Slave will also acknowledge the address byte and every data byte presented in Write mode. In Read mode the Slave shifts out a data byte, and then releases the SDA line during the 9th clock cycle. As long as the Master acknowledges the data, the Slave will continue transmitting. The Master terminates the session by not acknowledging the last data byte (NoACK) and by issuing a STOP condition. Bus timing is illustrated in Figure 5.

# CAT24C01, CAT24C02, CAT24C04, CAT24C08, CAT24C16

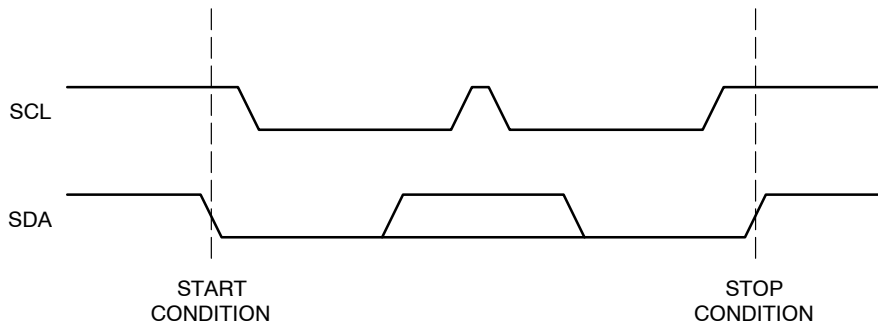

**Figure 2. Start/Stop Timing**

1	0	1	0	A <sub>2</sub>	A <sub>1</sub>	A <sub>0</sub>	R/ $\bar{W}$	CAT24C01 and CAT24C02
1	0	1	0	A <sub>2</sub>	A <sub>1</sub>	a <sub>8</sub>	R/ $\bar{W}$	CAT24C04
1	0	1	0	A <sub>2</sub>	a <sub>9</sub>	a <sub>8</sub>	R/ $\bar{W}$	CAT24C08
1	0	1	0	a <sub>10</sub>	a <sub>9</sub>	a <sub>8</sub>	R/ $\bar{W}$	CAT24C16

**Figure 3. Slave Address Bits**

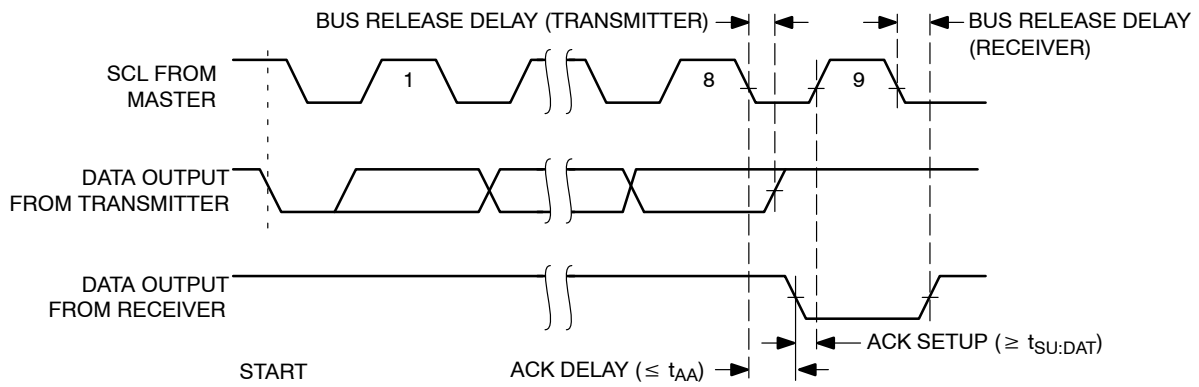

**Figure 4. Acknowledge Timing**

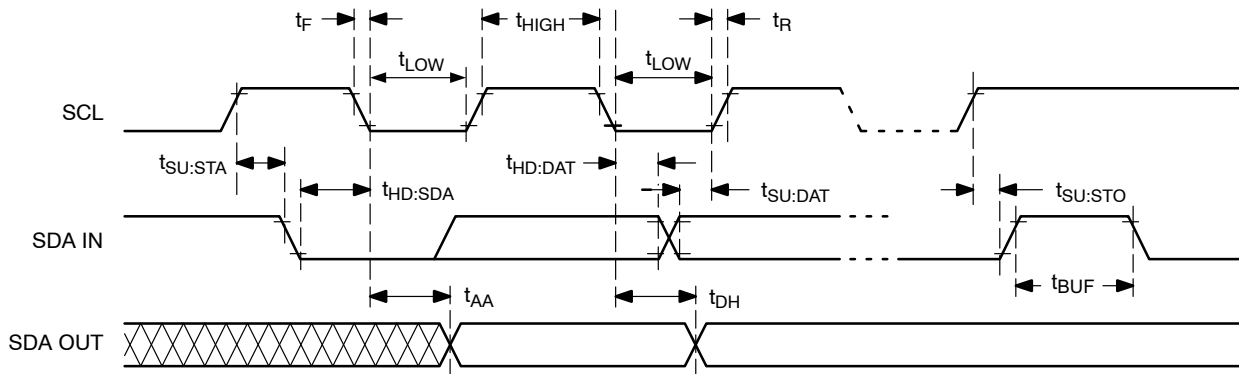

**Figure 5. Bus Timing**

WRITE OPERATIONS

**Byte Write**

In Byte Write mode, the Master sends the START condition and the Slave address with the R/W bit set to zero to the Slave. After the Slave generates an acknowledge, the Master sends the byte address that is to be written into the address pointer of the CAT24Cxx. After receiving another acknowledge from the Slave, the Master transmits the data byte to be written into the addressed memory location. The CAT24Cxx device will acknowledge the data byte and the Master generates the STOP condition, at which time the device begins its internal Write cycle to nonvolatile memory (Figure 6). While this internal cycle is in progress ( $t_{WR}$ ), the SDA output will be tri-stated and the CAT24Cxx will not respond to any request from the Master device (Figure 7).

**Page Write**

The CAT24Cxx writes up to 16 bytes of data in a single write cycle, using the Page Write operation (Figure 8). The Page Write operation is initiated in the same manner as the Byte Write operation, however instead of terminating after the data byte is transmitted, the Master is allowed to send up to fifteen additional bytes. After each byte has been transmitted the CAT24Cxx will respond with an acknowledge and internally increments the four low order address bits. The high order bits that define the page address remain unchanged. If the Master transmits more than sixteen bytes prior to sending the STOP condition, the address counter ‘wraps around’ to the beginning of page and previously transmitted data will be overwritten. Once all

sixteen bytes are received and the STOP condition has been sent by the Master, the internal Write cycle begins. At this point all received data is written to the CAT24Cxx in a single write cycle.

**Acknowledge Polling**

The acknowledge (ACK) polling routine can be used to take advantage of the typical write cycle time. Once the stop condition is issued to indicate the end of the host’s write operation, the CAT24Cxx initiates the internal write cycle. The ACK polling can be initiated immediately. This involves issuing the start condition followed by the slave address for a write operation. If the CAT24Cxx is still busy with the write operation, NoACK will be returned. If the CAT24Cxx has completed the internal write operation, an ACK will be returned and the host can then proceed with the next read or write operation.

**Hardware Write Protection**

With the WP pin held HIGH, the entire memory is protected against Write operations. If the WP pin is left floating or is grounded, it has no impact on the operation of the CAT24Cxx. The state of the WP pin is strobed on the last falling edge of SCL immediately preceding the first data byte (Figure 9). If the WP pin is HIGH during the strobe interval, the CAT24Cxx will not acknowledge the data byte and the Write request will be rejected.

**Delivery State**

The CAT24Cxx is shipped erased, i.e., all bytes are FFh.

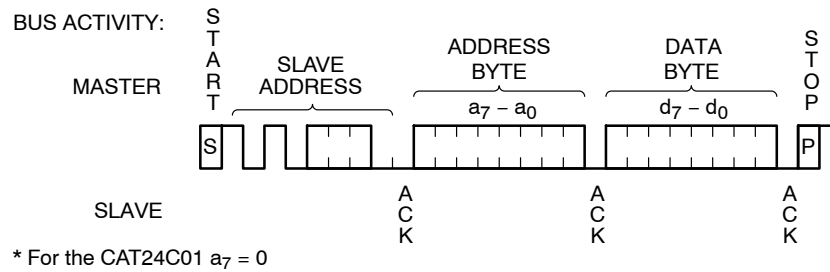
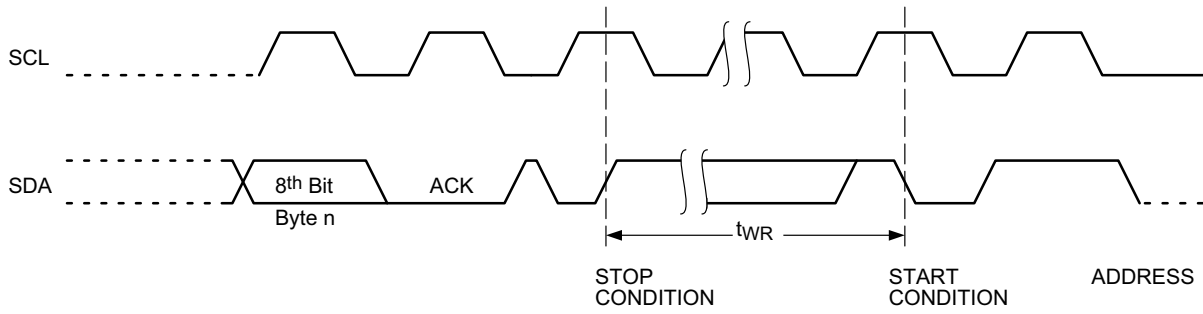
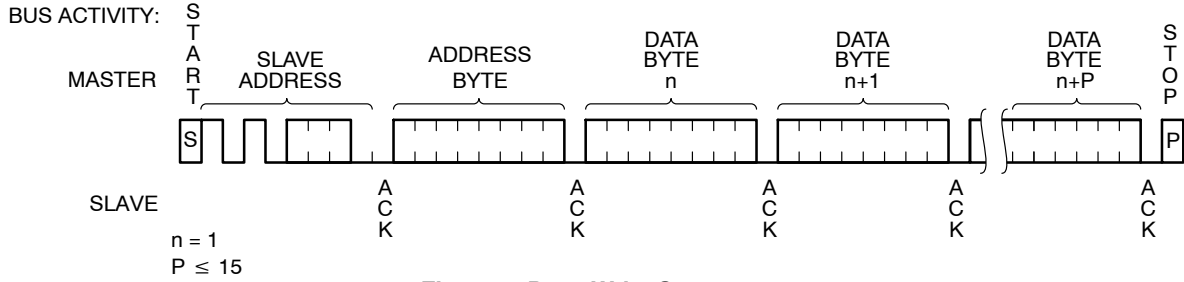

Figure 6. Byte Write Sequence

**CAT24C01, CAT24C02, CAT24C04, CAT24C08, CAT24C16**



**Figure 7. Write Cycle Timing**



**Figure 8. Page Write Sequence**

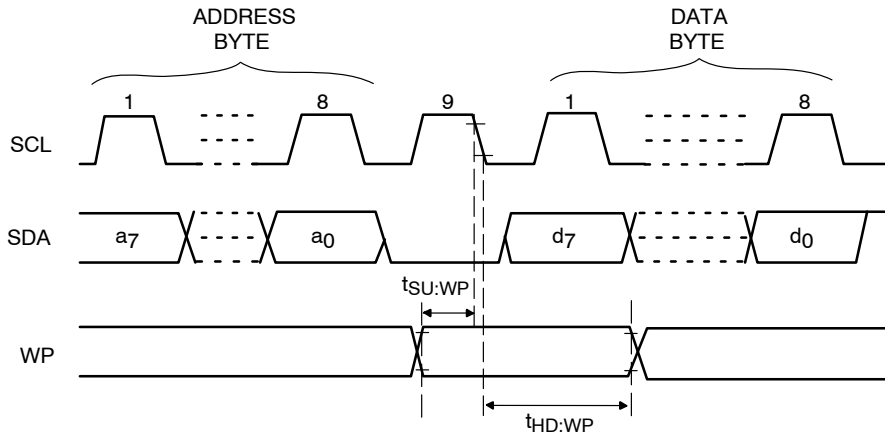

**Figure 9. WP Timing**

READ OPERATIONS

Immediate Read

Upon receiving a Slave address with the R/W bit set to '1', the CAT24Cxx will interpret this as a request for data residing at the current byte address in memory. The CAT24Cxx will acknowledge the Slave address, will immediately shift out the data residing at the current address, and will then wait for the Master to respond. If the Master does not acknowledge the data (NoACK) and then follows up with a STOP condition (Figure 10), the CAT24Cxx returns to Standby mode.

Selective Read

Selective Read operations allow the Master device to select at random any memory location for a read operation. The Master device first performs a 'dummy' write operation by sending the START condition, slave address and byte address of the location it wishes to read. After the

CAT24Cxx acknowledges the byte address, the Master device resends the START condition and the slave address, this time with the R/W bit set to one. The CAT24Cxx then responds with its acknowledge and sends the requested data byte. The Master device does not acknowledge the data (NoACK) but will generate a STOP condition (Figure 11).

Sequential Read

If during a Read session, the Master acknowledges the 1<sup>st</sup> data byte, then the CAT24Cxx will continue transmitting data residing at subsequent locations until the Master responds with a NoACK, followed by a STOP (Figure 12). In contrast to Page Write, during Sequential Read the address count will automatically increment to and then wrap-around at end of memory (rather than end of page). In the CAT24C01, the internal address count will not wrap around at the end of the 128 byte memory space.

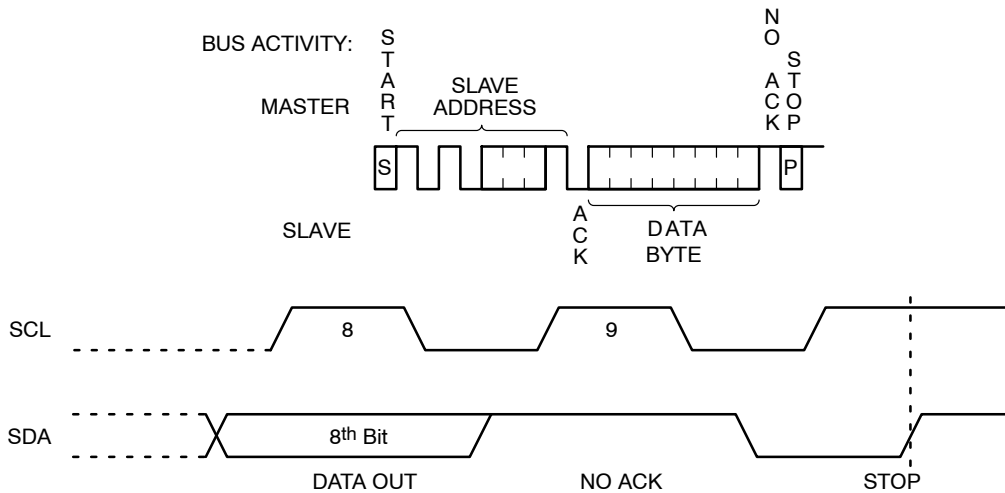

Figure 10. Immediate Read Sequence and Timing

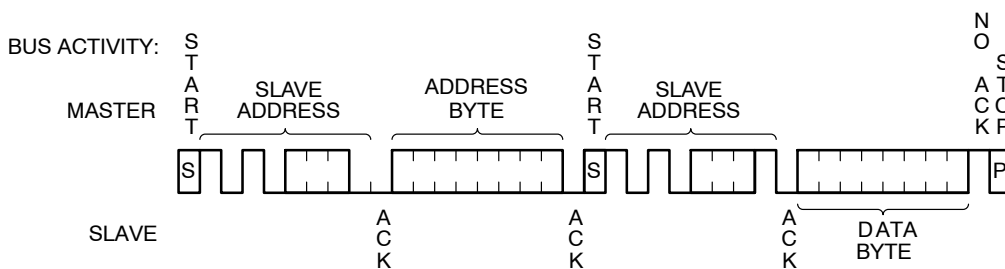

Figure 11. Selective Read Sequence

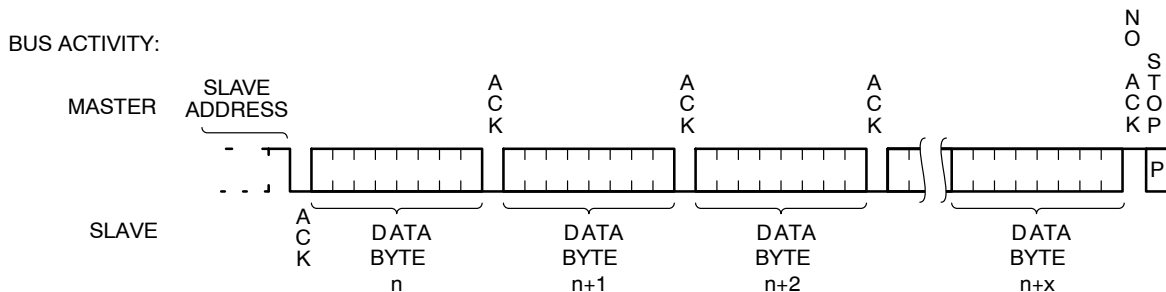

Figure 12. Sequential Read Sequence



# CAT24C01, CAT24C02, CAT24C04, CAT24C08, CAT24C16

## PACKAGE DIMENSIONS

PDIP-8, 300 mils  
CASE 646AA  
ISSUE A

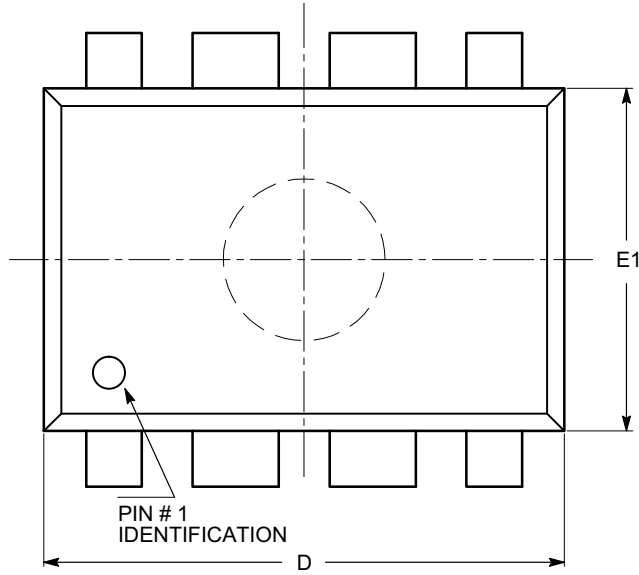

TOP VIEW

SYMBOL	MIN	NOM	MAX
A			5.33
A1	0.38		
A2	2.92	3.30	4.95
b	0.36	0.46	0.56
b2	1.14	1.52	1.78
c	0.20	0.25	0.36
D	9.02	9.27	10.16
E	7.62	7.87	8.25
E1	6.10	6.35	7.11
e	2.54 BSC		
eB	7.87		10.92
L	2.92	3.30	3.80

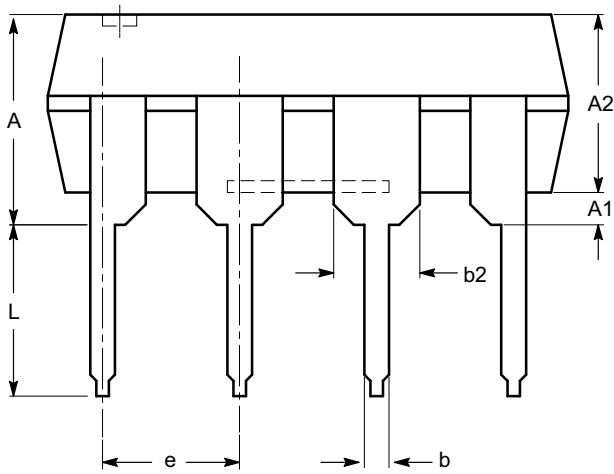

SIDE VIEW

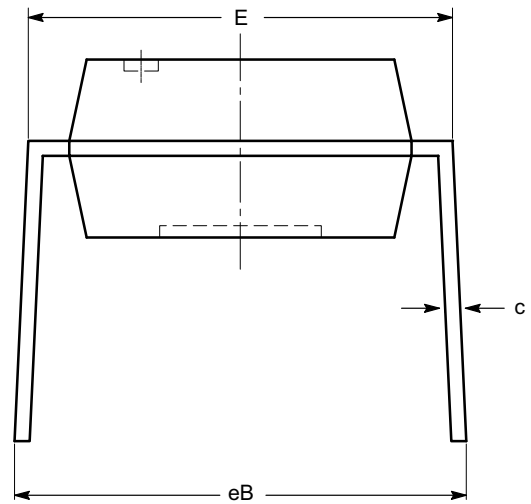

END VIEW

**Notes:**

- (1) All dimensions are in millimeters.
- (2) Complies with JEDEC MS-001.

# CAT24C01, CAT24C02, CAT24C04, CAT24C08, CAT24C16

## PACKAGE DIMENSIONS

SOIC 8, 150 mils  
CASE 751BD  
ISSUE O

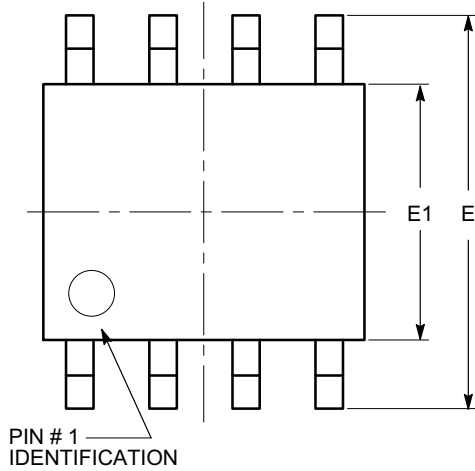

TOP VIEW

SYMBOL	MIN	NOM	MAX
A	1.35		1.75
A1	0.10		0.25
b	0.33		0.51
c	0.19		0.25
D	4.80		5.00
E	5.80		6.20
E1	3.80		4.00
e	1.27 BSC		
h	0.25		0.50
L	0.40		1.27
$\theta$	0°		8°

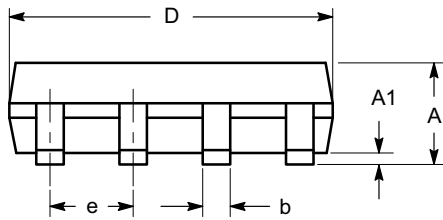

SIDE VIEW

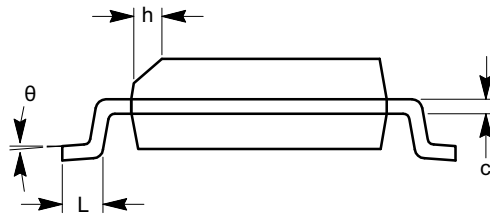

END VIEW

**Notes:**

- (1) All dimensions are in millimeters. Angles in degrees.
- (2) Complies with JEDEC MS-012.

# CAT24C01, CAT24C02, CAT24C04, CAT24C08, CAT24C16

## PACKAGE DIMENSIONS

TSSOP8, 4.4x3  
CASE 948AL  
ISSUE O

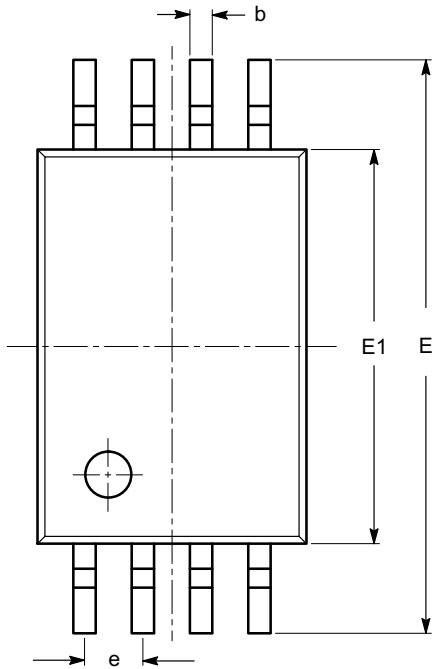

SYMBOL	MIN	NOM	MAX
A			1.20
A1	0.05		0.15
A2	0.80	0.90	1.05
b	0.19		0.30
c	0.09		0.20
D	2.90	3.00	3.10
E	6.30	6.40	6.50
E1	4.30	4.40	4.50
e	0.65 BSC		
L	1.00 REF		
L1	0.50	0.60	0.75
$\theta$	0°		8°

TOP VIEW

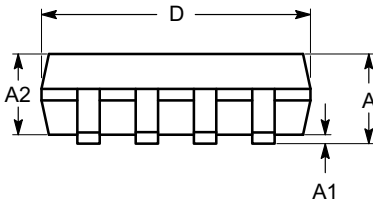

SIDE VIEW

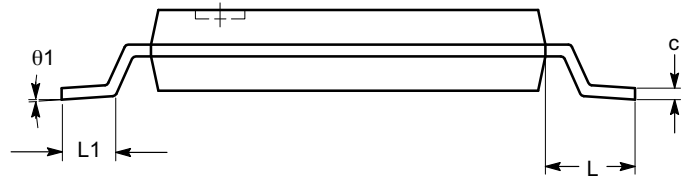

END VIEW

**Notes:**

- (1) All dimensions are in millimeters. Angles in degrees.
- (2) Complies with JEDEC MO-153.

# CAT24C01, CAT24C02, CAT24C04, CAT24C08, CAT24C16

## PACKAGE DIMENSIONS

MSOP 8, 3x3  
CASE 846AD  
ISSUE O

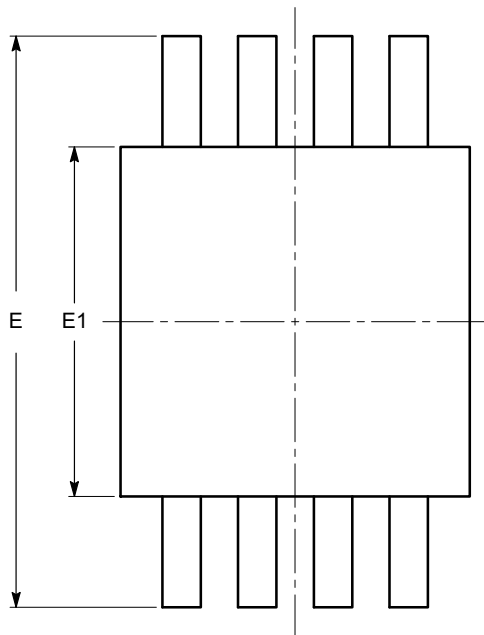

TOP VIEW

SYMBOL	MIN	NOM	MAX
A			1.10
A1	0.05	0.10	0.15
A2	0.75	0.85	0.95
b	0.22		0.38
c	0.13		0.23
D	2.90	3.00	3.10
E	4.80	4.90	5.00
E1	2.90	3.00	3.10
e	0.65 BSC		
L	0.40	0.60	0.80
L1	0.95 REF		
L2	0.25 BSC		
$\theta$	0°		6°

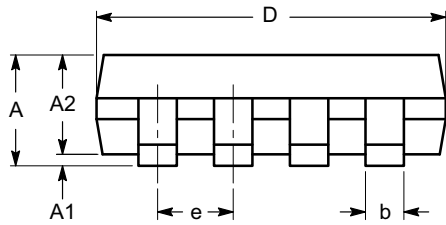

SIDE VIEW

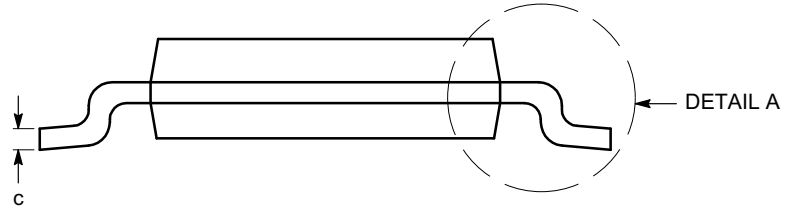

END VIEW

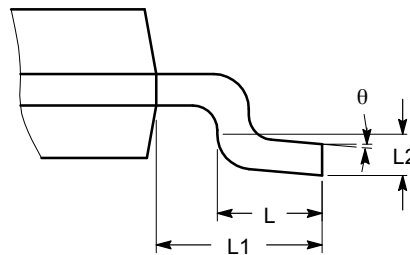

DETAIL A

**Notes:**

- (1) All dimensions are in millimeters. Angles in degrees.
- (2) Complies with JEDEC MO-187.

PACKAGE DIMENSIONS

TDFN8, 2x3  
CASE 511AK  
ISSUE A

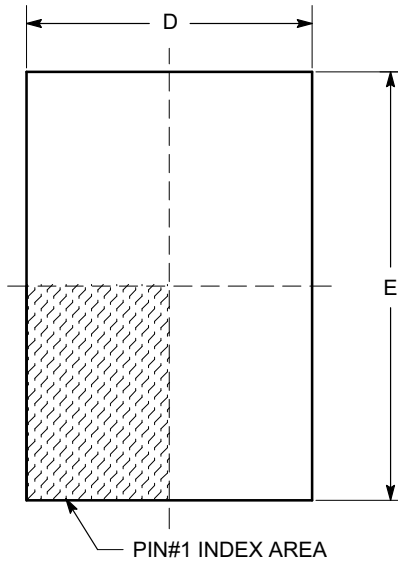

TOP VIEW

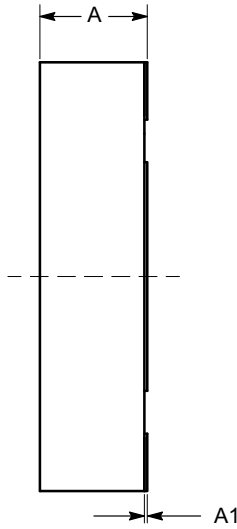

SIDE VIEW

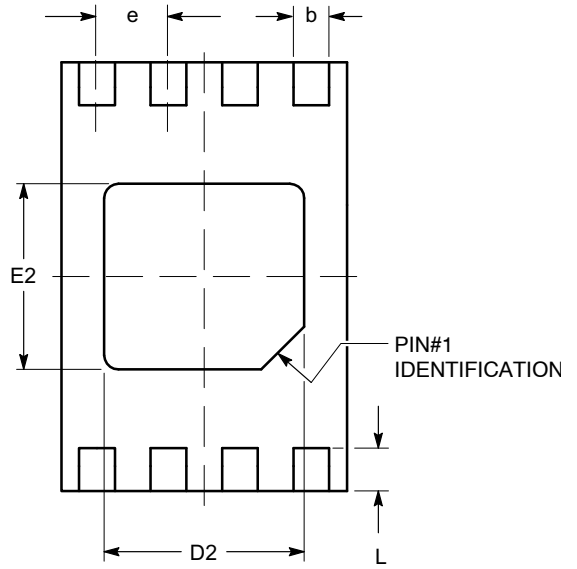

BOTTOM VIEW

SYMBOL	MIN	NOM	MAX
A	0.70	0.75	0.80
A1	0.00	0.02	0.05
A2	0.45	0.55	0.65
A3	0.20 REF		
b	0.20	0.25	0.30
D	1.90	2.00	2.10
D2	1.30	1.40	1.50
E	2.90	3.00	3.10
E2	1.20	1.30	1.40
e	0.50 TYP		
L	0.20	0.30	0.40

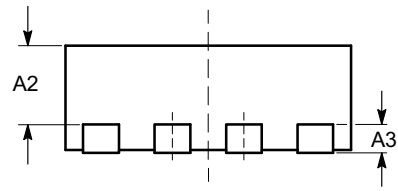

FRONT VIEW

Notes:

- (1) All dimensions are in millimeters.
- (2) Complies with JEDEC MO-229.

# CAT24C01, CAT24C02, CAT24C04, CAT24C08, CAT24C16

## PACKAGE DIMENSIONS

TSOT-23, 5 LEAD  
CASE 419AE  
ISSUE O

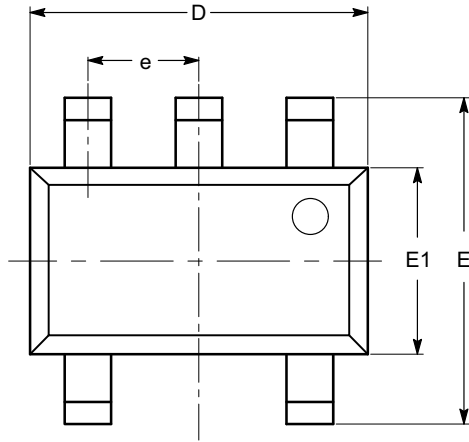

TOP VIEW

SYMBOL	MIN	NOM	MAX
A			1.00
A1	0.01	0.05	0.10
A2	0.80	0.87	0.90
b	0.30		0.45
c	0.12	0.15	0.20
D	2.90 BSC		
E	2.80 BSC		
E1	1.60 BSC		
e	0.95 TYP		
L	0.30	0.40	0.50
L1	0.60 REF		
L2	0.25 BSC		
$\theta$	0°		8°

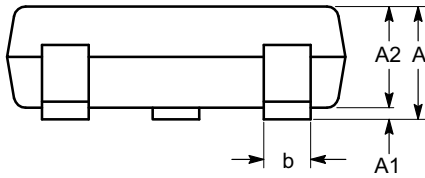

SIDE VIEW

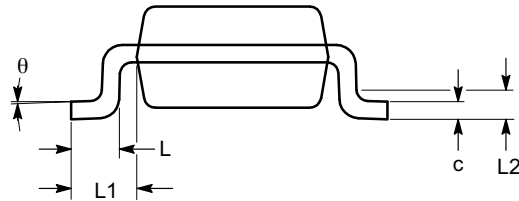

END VIEW

**Notes:**

- (1) All dimensions are in millimeters. Angles in degrees.
- (2) Complies with JEDEC MO-193.

# CAT24C01, CAT24C02, CAT24C04, CAT24C08, CAT24C16

## PACKAGE DIMENSIONS

### TSOP-5 CASE 483-02 ISSUE H

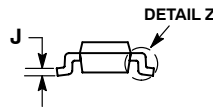
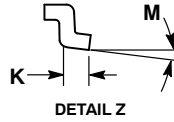
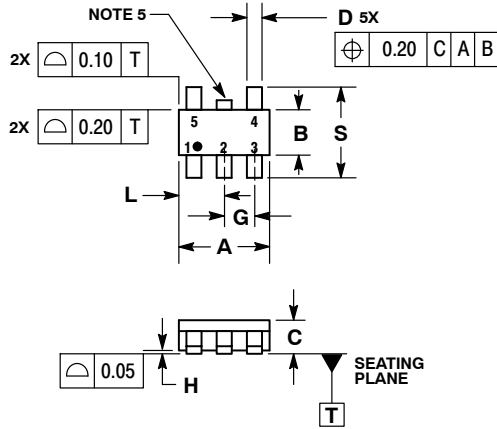

#### NOTES:

1. DIMENSIONING AND TOLERANCING PER ASME Y14.5M, 1994.
2. CONTROLLING DIMENSION: MILLIMETERS.
3. MAXIMUM LEAD THICKNESS INCLUDES LEAD FINISH THICKNESS. MINIMUM LEAD THICKNESS IS THE MINIMUM THICKNESS OF BASE MATERIAL.
4. DIMENSIONS A AND B DO NOT INCLUDE MOLD FLASH, PROTRUSIONS, OR GATE BURRS.
5. OPTIONAL CONSTRUCTION: AN ADDITIONAL TRIMMED LEAD IS ALLOWED IN THIS LOCATION. TRIMMED LEAD NOT TO EXTEND MORE THAN 0.2 FROM BODY.

DIM	MILLIMETERS	
	MIN	MAX
A	3.00 BSC	
B	1.50 BSC	
C	0.90	1.10
D	0.25	0.50
G	0.95 BSC	
H	0.01	0.10
J	0.10	0.26
K	0.20	0.60
L	1.25	1.55
M	0° 10°	
S	2.50	3.00

#### SOLDERING FOOTPRINT\*

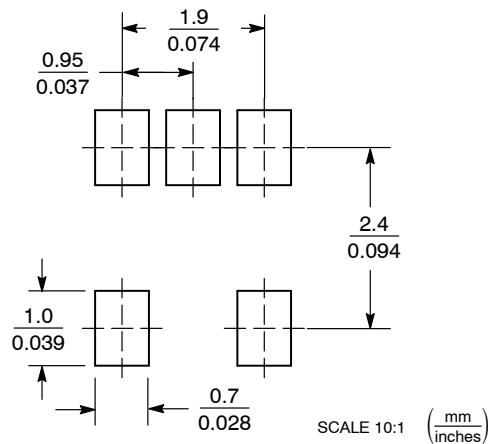

\*For additional information on our Pb-Free strategy and soldering details, please download the ON Semiconductor Soldering and Mounting Techniques Reference Manual, SOLDERRM/D.

# CAT24C01, CAT24C02, CAT24C04, CAT24C08, CAT24C16

## PACKAGE DIMENSIONS

UDFN8, 2x3 EXTENDED PAD  
CASE 517AZ  
ISSUE O

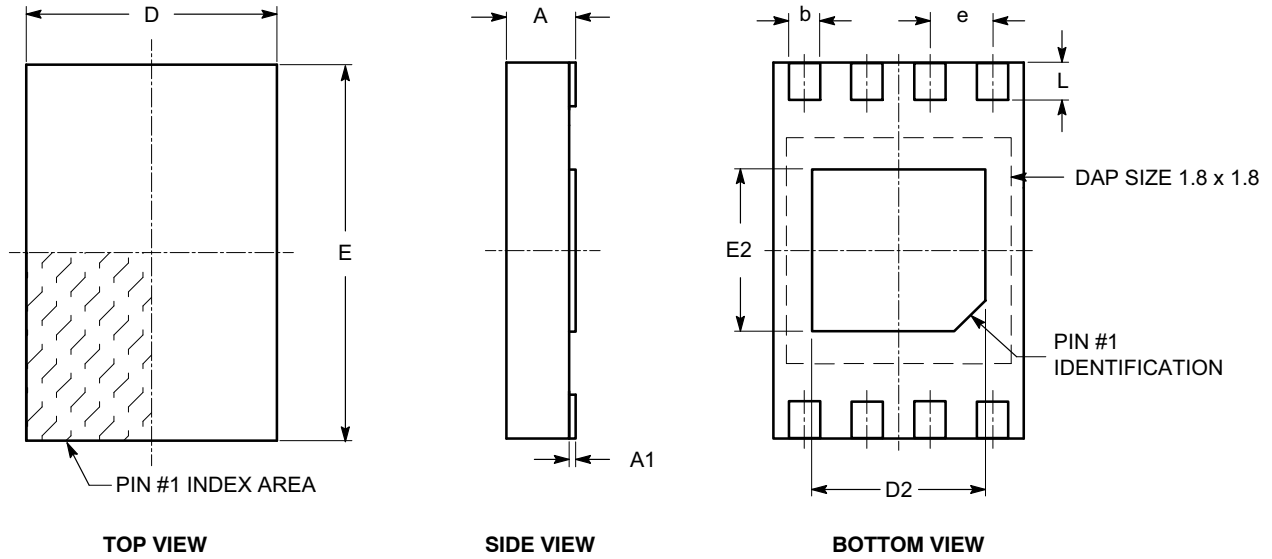

SYMBOL	MIN	NOM	MAX
A	0.45	0.50	0.55
A1	0.00	0.02	0.05
A3	0.127 REF		
b	0.20	0.25	0.30
D	1.95	2.00	2.05
D2	1.35	1.40	1.45
E	2.95	3.00	3.05
E2	1.25	1.30	1.35
e	0.50 REF		
L	0.25	0.30	0.35

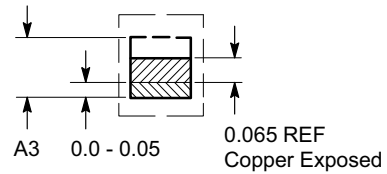
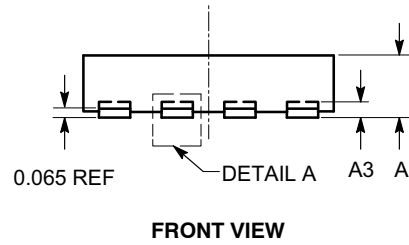

**Notes:**

- (1) All dimensions are in millimeters.
- (2) Refer JEDEC MO-236/MO-252.



# CAT24C01, CAT24C02, CAT24C04, CAT24C08, CAT24C16

## PACKAGE DIMENSIONS

WLCSP4, 0.84x0.86  
CASE 567DC  
ISSUE D

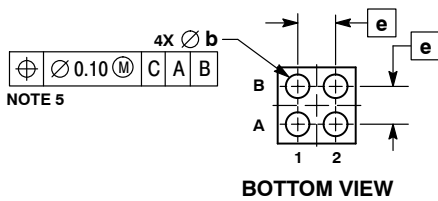
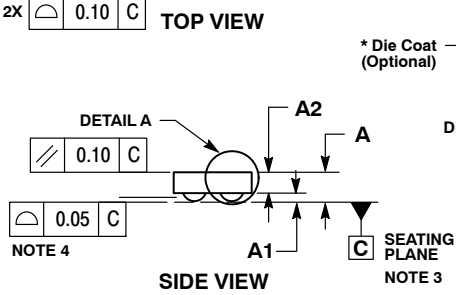
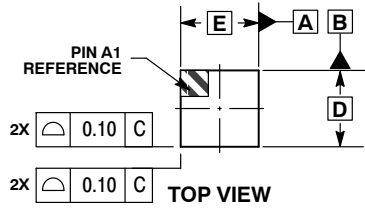

**NOTES:**

1. DIMENSIONING AND TOLERANCING PER ASME Y14.5M, 1994.
2. CONTROLLING DIMENSION: MILLIMETERS.
3. DATUM C, THE SEATING PLANE, IS DEFINED BY THE SPHERICAL CROWNS OF THE CONTACT BALLS.
4. COPLANARITY APPLIES TO SPHERICAL CROWNS OF THE CONTACT BALLS.
5. DIMENSION b IS MEASURED AT THE MAXIMUM CONTACT BALL DIAMETER PARALLEL TO DATUM C.

MILLIMETERS		
DIM	MIN	MAX
A	0.28	0.38
A1	0.08	0.12
A2	0.23 REF	
A3*	0.025 REF	
b	0.16	0.20
D	0.84 BSC	
E	0.86 BSC	
e	0.40 BSC	

\* Die Coat (Optional)

### RECOMMENDED SOLDERING FOOTPRINT\*

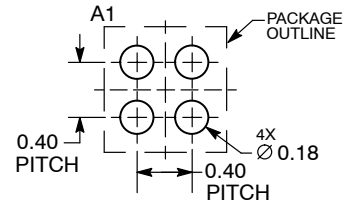

DIMENSIONS: MILLIMETERS

\*For additional information on our Pb-Free strategy and soldering details, please download the ON Semiconductor Soldering and Mounting Techniques Reference Manual, SOLDERRM/D.

# CAT24C01, CAT24C02, CAT24C04, CAT24C08, CAT24C16

## PACKAGE DIMENSIONS

WLCSP5, 0.86x0.84  
CASE 567DD  
ISSUE C

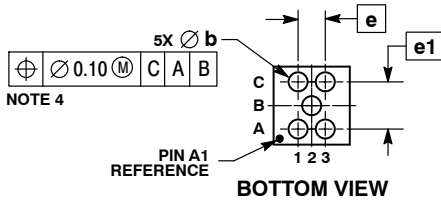
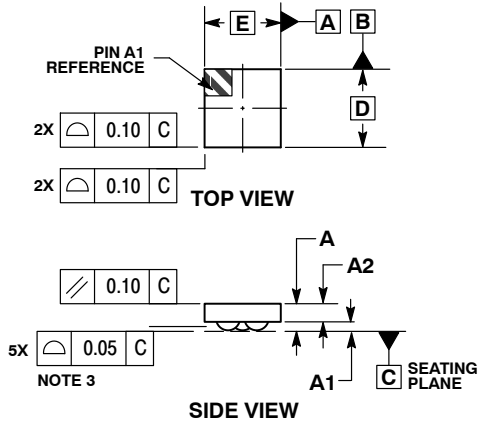

### NOTES:

1. DIMENSIONING AND TOLERANCING PER ASME Y14.5M, 1994.
2. CONTROLLING DIMENSION: MILLIMETERS.
3. DATUM C, THE SEATING PLANE, IS DEFINED BY THE SPHERICAL CROWNS OF THE CONTACT BALLS.
4. COPLANARITY APPLIES TO SPHERICAL CROWNS OF THE CONTACT BALLS.
5. DIMENSION b IS MEASURED AT THE MAXIMUM CONTACT BALL DIAMETER PARALLEL TO DATUM C.

DIM	MILLIMETERS	
	MIN	MAX
A	0.29	0.39
A1	0.10	0.14
A2	0.23	REF
b	0.14	0.18
D	0.86	BSC
E	0.84	BSC
e	0.30	BSC
e1	0.52	BSC

### RECOMMENDED SOLDERING FOOTPRINT\*

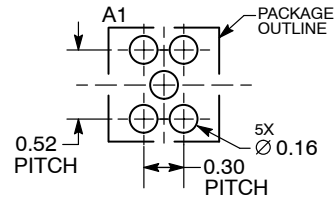

DIMENSIONS: MILLIMETERS

\*For additional information on our Pb-Free strategy and soldering details, please download the ON Semiconductor Soldering and Mounting Techniques Reference Manual, SOLDERRM/D.

# CAT24C01, CAT24C02, CAT24C04, CAT24C08, CAT24C16

## Ordering Information

### CAT24C01 Ordering Information

Device Order Number	Specific Device Marking	Package Type	Temperature Range (Note 9)	Lead Finish	Shipping
CAT24C01TDI-GT3	MM	TSOT-23-5	Industrial	NiPdAu	Tape & Reel, 3,000 Units / Reel
CAT24C01VP2I-GT3*	EE	TDFN-8	Industrial	NiPdAu	Tape & Reel, 3,000 Units / Reel
CAT24C01WI-GT3	24C01WI	SOIC-8	Industrial	NiPdAu	Tape & Reel, 3,000 Units / Reel
CAT24C01WE-GT3	24C01WI	SOIC-8	Extended	NiPdAu	Tape & Reel, 3,000 Units / Reel
CAT24C01YI-GT3	C01	TSSOP-8	Industrial	NiPdAu	Tape & Reel, 3,000 Units / Reel
CAT24C01YE-GT3	C01	TSSOP-8	Extended	NiPdAu	Tape & Reel, 3,000 Units / Reel
CAT24C01ZI-GT3	ABMK	MSOP-8	Industrial	NiPdAu	Tape & Reel, 3,000 Units / Reel

### CAT24C02 Ordering Information (Notes 10, 11)

Device Order Number	Specific Device Marking	Package Type	Temperature Range (Note 9)	Lead Finish	Shipping
CAT24C02WI-G	24C02H	SOIC-8	Industrial	NiPdAu	Tube, 100 Units / Tube
CAT24C02WI-GA	24C02H	SOIC-8	Industrial	NiPdAu	Tube, 100 Units / Tube
CAT24C02WI-GT3	24C02H	SOIC-8	Industrial	NiPdAu	Tape & Reel, 3,000 Units / Reel
CAT24C02WI-GT3A	24C02H	SOIC-8	Industrial	NiPdAu	Tape & Reel, 3,000 Units / Reel
CAT24C02WE-GT3	24C02H	SOIC-8	Extended	NiPdAu	Tape & Reel, 3,000 Units / Reel
CAT24C02WE-GT3A	24C02H	SOIC-8	Extended	NiPdAu	Tape & Reel, 3,000 Units / Reel
CAT24C02YI-G	C02H	TSSOP-8	Industrial	NiPdAu	Tube, 100 Units / Tube
CAT24C02YI-GA	C02H	TSSOP-8	Industrial	NiPdAu	Tube, 100 Units / Tube
CAT24C02YI-GT3	C02H	TSSOP-8	Industrial	NiPdAu	Tape & Reel, 3,000 Units / Reel
CAT24C02YI-GT3A	C02H	TSSOP-8	Industrial	NiPdAu	Tape & Reel, 3,000 Units / Reel
CAT24C02YE-GT3	C02H	TSSOP-8	Extended	NiPdAu	Tape & Reel, 3,000 Units / Reel
CAT24C02YE-GT3A	C02H	TSSOP-8	Extended	NiPdAu	Tape & Reel, 3,000 Units / Reel
CAT24C02VP2I-GT3*	C1T	TDFN-8	Industrial	NiPdAu	Tape & Reel, 3,000 Units / Reel
CAT24C02VP2IGT3A*	C1T	TDFN-8	Industrial	NiPdAu	Tape & Reel, 3,000 Units / Reel
CAT24C02VP2E-GT3*	C1T	TDFN-8	Extended	NiPdAu	Tape & Reel, 3,000 Units / Reel
CAT24C02VP2EGT3A*	C1T	TDFN-8	Extended	NiPdAu	Tape & Reel, 3,000 Units / Reel
CAT24C02ZI-GT3	C1	MSOP-8	Industrial	NiPdAu	Tape & Reel, 3,000 Units / Reel
CAT24C02ZE-GT3	C1	MSOP-8	Extended	NiPdAu	Tape & Reel, 3,000 Units / Reel
CAT24C02ZI-GT3A	C1	MSOP-8	Industrial	NiPdAu	Tape & Reel, 3,000 Units / Reel
CAT24C02ZE-GT3A	C1	MSOP-8	Extended	NiPdAu	Tape & Reel, 3,000 Units / Reel
CAT24C02TDI-GT3	C1	TSOT-23-5	Industrial	NiPdAu	Tape & Reel, 3,000 Units / Reel
CAT24C02TDE-GT3	C1	TSOT-23-5	Extended	NiPdAu	Tape & Reel, 3,000 Units / Reel
CAT24C02TDI-GT3A	C1	TSOT-23-5	Industrial	NiPdAu	Tape & Reel, 3,000 Units / Reel
CAT24C02TDE-GT3A	C1	TSOT-23-5	Extended	NiPdAu	Tape & Reel, 3,000 Units / Reel
CAT24C02LI-GA	24C02H	PDIP-8	Industrial	NiPdAu	Tube, 50 Units / Tube
CAT24C02LE-GA	24C02H	PDIP-8	Extended	NiPdAu	Tube, 50 Units / Tube
CAT24C02HU4IGT3A	C1U	UDFN8-EP	Industrial	NiPdAu	Tape & Reel, 3,000 Units / Reel
CAT24C02HU4EGT3A	C1U	UDFN8-EP	Extended	NiPdAu	Tape & Reel, 3,000 Units / Reel
CAT24C02TSI-T3	C1	TSOP-5	Industrial	Matte-Tin	Tape & Reel, 3,000 Units / Reel

9. Industrial temperature range is -40°C to +85°C and Extended temperature range is -40°C to +125°C.

10. Part numbers ending with "A" for the CAT24C02 are for Gresham (Product Rev H) only die.

11. The CAT24C02 "non-A" Device Order Numbers use Gresham die (Rev H) for date codes, starting August 1st, 2012. Therefore the Specific Device Marking for these OPNs reflect Rev H die.

\* The TDFN (VP2) package is not recommended for new designs.

## CAT24C01, CAT24C02, CAT24C04, CAT24C08, CAT24C16

### CAT24C04 Ordering Information

Device Order Number	Specific Device Marking	Package Type	Temperature Range (Note 12)	Lead Finish	Shipping
CAT24C04WI-G	24C04K	SOIC-8	Industrial	NiPdAu	Tube, 100 Units / Tube
CAT24C04WI-GT3	24C04K	SOIC-8	Industrial	NiPdAu	Tape & Reel, 3,000 Units / Reel
CAT24C04WE-GT3	24C04K	SOIC-8	Extended	NiPdAu	Tape & Reel, 3,000 Units / Reel
CAT24C04YI-G	C04K	TSSOP-8	Industrial	NiPdAu	Tube, 100 Units / Tube
CAT24C04YI-GT3	C04K	TSSOP-8	Industrial	NiPdAu	Tape & Reel, 3,000 Units / Reel
CAT24C04YE-GT3	C04K	TSSOP-8	Extended	NiPdAu	Tape & Reel, 3,000 Units / Reel
CAT24C04VP2I-GT3*	C2T	TDFN-8	Industrial	NiPdAu	Tape & Reel, 3,000 Units / Reel
CAT24C04LI-G	24C04K	PDIP-8	Industrial	NiPdAu	Tube, 50 Units / Tube
CAT24C04LE-G	24C04K	PDIP-8	Extended	NiPdAu	Tube, 50 Units / Tube
CAT24C04ZI-GT3	C2	MSOP-8	Industrial	NiPdAu	Tape & Reel, 3,000 Units / Reel
CAT24C04ZE-GT3	C2	MSOP-8	Extended	NiPdAu	Tape & Reel, 3,000 Units / Reel
CAT24C04C4ATR	4	WLCSP-4	Industrial	N/A	Tape & Reel, 5,000 Units / Reel
CAT24C04C5ATR	4	WLCSP-5	Industrial	N/A	Tape & Reel, 5,000 Units / Reel
CAT24C04TDI-GT3	C2	TSOT-23-5	Industrial	NiPdAu	Tape & Reel, 3,000 Units / Reel
CAT24C04TDE-GT3	C2	TSOT-23-5	Extended	NiPdAu	Tape & Reel, 3,000 Units / Reel
CAT24C04HU4I-GT3	C2U	UDFN8-EP	Industrial	NiPdAu	Tape & Reel, 3,000 Units / Reel
CAT24C04HU4E-GT3	C2U	UDFN8-EP	Extended	NiPdAu	Tape & Reel, 3,000 Units / Reel

### CAT24C08 Ordering Information

Device Order Number	Specific Device Marking	Package Type	Temperature Range (Note 12)	Lead Finish	Shipping
CAT24C08WI-G	24C08K	SOIC-8	Industrial	NiPdAu	Tube, 100 Units / Tube
CAT24C08WI-GT3	24C08K	SOIC-8	Industrial	NiPdAu	Tape & Reel, 3,000 Units / Reel
CAT24C08WE-GT3	24C08K	SOIC-8	Extended	NiPdAu	Tape & Reel, 3,000 Units / Reel
CAT24C08YI-G	C08K	TSSOP-8	Industrial	NiPdAu	Tube, 100 Units / Tube
CAT24C08YI-GT3	C08K	TSSOP-8	Industrial	NiPdAu	Tape & Reel, 3,000 Units / Reel
CAT24C08YE-GT3	C08K	TSSOP-8	Extended	NiPdAu	Tape & Reel, 3,000 Units / Reel
CAT24C08VP2I-GT3*	C3T	TDFN-8	Industrial	NiPdAu	Tape & Reel, 3,000 Units / Reel
CAT24C08VP2E-GT3*	C3T	TDFN-8	Extended	NiPdAu	Tape & Reel, 3,000 Units / Reel
CAT24C08LI-G	24C08K	PDIP-8	Industrial	NiPdAu	Tube, 50 Units / Tube
CAT24C08LE-G	24C08K	PDIP-8	Extended	NiPdAu	Tube, 50 Units / Tube
CAT24C08ZI-GT3	C3	MSOP-8	Industrial	NiPdAu	Tape & Reel, 3,000 Units / Reel
CAT24C08ZE-GT3	C3	MSOP-8	Extended	NiPdAu	Tape & Reel, 3,000 Units / Reel
CAT24C08C4ATR	8	WLCSP-4	Industrial	N/A	Tape & Reel, 5,000 Units / Reel
CAT24C08C4CTR**	8	WLCSP-4	Industrial	N/A	Tape & Reel, 5,000 Units / Reel
CAT24C08C5ATR	8	WLCSP-5	Industrial	N/A	Tape & Reel, 5,000 Units / Reel
CAT24C08TDI-GT3	C3	TSOT-23-5	Industrial	NiPdAu	Tape & Reel, 3,000 Units / Reel
CAT24C08TDE-GT3	C3	TSOT-23-5	Extended	NiPdAu	Tape & Reel, 3,000 Units / Reel
CAT24C08HU4I-GT3	C3U	UDFN8-EP	Industrial	NiPdAu	Tape & Reel, 3,000 Units / Reel
CAT24C08HU4E-GT3	C3U	UDFN8-EP	Extended	NiPdAu	Tape & Reel, 3,000 Units / Reel

12. Industrial temperature range is -40°C to +85°C and Extended temperature range is -40°C to +125°C.

\* The TDFN (VP2) package is not recommended for new designs.

\*\* CAT24C08C4CTR is a backside coated version. Contact factory for other densities.

# CAT24C01, CAT24C02, CAT24C04, CAT24C08, CAT24C16

## CAT24C16 Ordering Information

Device Order Number	Specific Device Marking	Package Type	Temperature Range (Note 13)	Lead Finish	Shipping
CAT24C16WI-G	24C16K	SOIC-8	Industrial	NiPdAu	Tube, 100 Units / Tube
CAT24C16WI-GT3	24C16K	SOIC-8	Industrial	NiPdAu	Tape & Reel, 3,000 Units / Reel
CAT24C16WE-GT3	24C16K	SOIC-8	Extended	NiPdAu	Tape & Reel, 3,000 Units / Reel
CAT24C16YI-G	C16K	TSSOP-8	Industrial	NiPdAu	Tube, 100 Units / Tube
CAT24C16YI-GT3	C16K	TSSOP-8	Industrial	NiPdAu	Tape & Reel, 3,000 Units / Reel
CAT24C16YE-GT3	C16K	TSSOP-8	Extended	NiPdAu	Tape & Reel, 3,000 Units / Reel
CAT24C16VP2I-GT3*	C4T	TDFN-8	Industrial	NiPdAu	Tape & Reel, 3,000 Units / Reel
CAT24C16VP2E-GT3*	C4T	TDFN-8	Extended	NiPdAu	Tape & Reel, 3,000 Units / Reel
CAT24C16LI-G	24C16K	PDIP-8	Industrial	NiPdAu	Tube, 50 Units / Tube
CAT24C16LE-G	24C16K	PDIP-8	Extended	NiPdAu	Tube, 50 Units / Tube
CAT24C16ZI-GT3	C4	MSOP-8	Industrial	NiPdAu	Tape & Reel, 3,000 Units / Reel
CAT24C16ZE-GT3	C4	MSOP-8	Extended	NiPdAu	Tape & Reel, 3,000 Units / Reel
CAT24C16C4ATR	6	WLCSP-4	Industrial	N/A	Tape & Reel, 5,000 Units / Reel
CAT24C16C5ATR	6	WLCSP-5	Industrial	N/A	Tape & Reel, 5,000 Units / Reel
CAT24C16TDI-GT3	C4	TSOT-23-5	Industrial	NiPdAu	Tape & Reel, 3,000 Units / Reel
CAT24C16TDE-GT3	C4	TSOT-23-5	Extended	NiPdAu	Tape & Reel, 3,000 Units / Reel
CAT24C16HU4I-GT3	C4U	UDFN8-EP	Extended	NiPdAu	Tape & Reel, 3,000 Units / Reel

13. Industrial temperature range is -40°C to +85°C and Extended temperature range is -40°C to +125°C.

14. All packages are RoHS-compliant (Lead-free, Halogen-free).

15. For information on tape and reel specifications, including part orientation and tape sizes, please refer to our Tape and Reel Packaging Specifications Brochure, BRD8011/D.

16. For detailed information and a breakdown of device nomenclature and numbering systems, please see the ON Semiconductor Device Nomenclature document, TND310/D, available at [www.onsemi.com](http://www.onsemi.com)

\* The TDFN (VP2) package is not recommended for new designs.

ON Semiconductor is licensed by Philips Corporation to carry the I<sup>2</sup>C Bus Protocol.

ON Semiconductor and  are registered trademarks of Semiconductor Components Industries, LLC (SCILLC). SCILLC owns the rights to a number of patents, trademarks, copyrights, trade secrets, and other intellectual property. A listing of SCILLC's product/patent coverage may be accessed at [www.onsemi.com/site/pdf/Patent-Marking.pdf](http://www.onsemi.com/site/pdf/Patent-Marking.pdf). SCILLC reserves the right to make changes without further notice to any products herein. SCILLC makes no warranty, representation or guarantee regarding the suitability of its products for any particular purpose, nor does SCILLC assume any liability arising out of the application or use of any product or circuit, and specifically disclaims any and all liability, including without limitation special, consequential or incidental damages. "Typical" parameters which may be provided in SCILLC data sheets and/or specifications can and do vary in different applications and actual performance may vary over time. All operating parameters, including "Typicals" must be validated for each customer application by customer's technical experts. SCILLC does not convey any license under its patent rights nor the rights of others. SCILLC products are not designed, intended, or authorized for use as components in systems intended for surgical implant into the body, or other applications intended to support or sustain life, or for any other application in which the failure of the SCILLC product could create a situation where personal injury or death may occur. Should Buyer purchase or use SCILLC products for any such unintended or unauthorized application, Buyer shall indemnify and hold SCILLC and its officers, employees, subsidiaries, affiliates, and distributors harmless against all claims, costs, damages, and expenses, and reasonable attorney fees arising out of, directly or indirectly, any claim of personal injury or death associated with such unintended or unauthorized use, even if such claim alleges that SCILLC was negligent regarding the design or manufacture of the part. SCILLC is an Equal Opportunity/Affirmative Action Employer. This literature is subject to all applicable copyright laws and is not for resale in any manner.

## PUBLICATION ORDERING INFORMATION

### LITERATURE FULFILLMENT:

Literature Distribution Center for ON Semiconductor  
P.O. Box 5163, Denver, Colorado 80217 USA  
Phone: 303-675-2175 or 800-344-3860 Toll Free USA/Canada  
Fax: 303-675-2176 or 800-344-3867 Toll Free USA/Canada  
Email: [orderlit@onsemi.com](mailto:orderlit@onsemi.com)

**N. American Technical Support:** 800-282-9855 Toll Free  
USA/Canada  
**Europe, Middle East and Africa Technical Support:**  
Phone: 421 33 790 2910  
**Japan Customer Focus Center**  
Phone: 81-3-5817-1050

**ON Semiconductor Website:** [www.onsemi.com](http://www.onsemi.com)

**Order Literature:** <http://www.onsemi.com/orderlit>

For additional information, please contact your local Sales Representative