

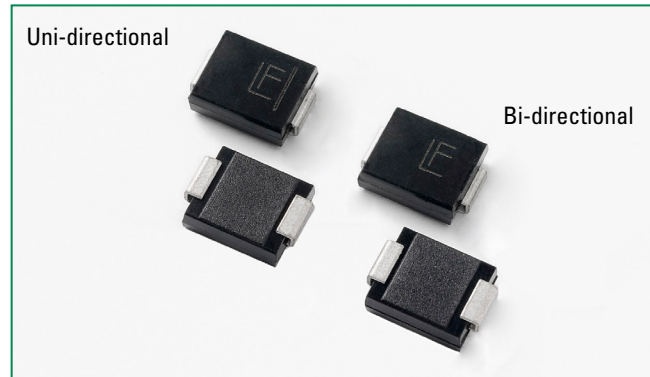

5.0SMDJ Series



Agency Approvals

AGENCY	AGENCY FILE NUMBER
	E230531

Maximum Ratings and Thermal Characteristics (T_A=25°C unless otherwise noted)

Parameter	Symbol	Value	Unit
Peak Pulse Power Dissipation at T _A =25°C by 10/1000µs Waveform (Fig.2)(Note 1), (Note 2)	P _{PPM}	5000	W
Power Dissipation on Infinite Heat Sink at T _A =50°C	P _{M(AV)}	6.5	W
Peak Forward Surge Current, 8.3ms Single Half Sine Wave (Note 3)	I _{FSM}	300	A
Maximum Instantaneous Forward Voltage at 100A for Unidirectional Only	V _F	5.0	V
Operating Junction and Storage Temperature Range	T _J , T _{STG}	-55 to 150	°C
Typical Thermal Resistance Junction to Lead	R _{θJL}	15	°C/W
Typical Thermal Resistance Junction to Ambient	R _{θJA}	75	°C/W

Notes:

- Non-repetitive current pulse, per Fig. 4 and derated above T_A = 25°C per Fig. 3.
- Mounted on copper pad area of 0.31x0.31" (8.0 x 8.0mm) to each terminal.
- Measured on 8.3ms single half sine wave or equivalent square wave for unidirectional device only, duty cycle=4 per minute maximum.

Functional Diagram

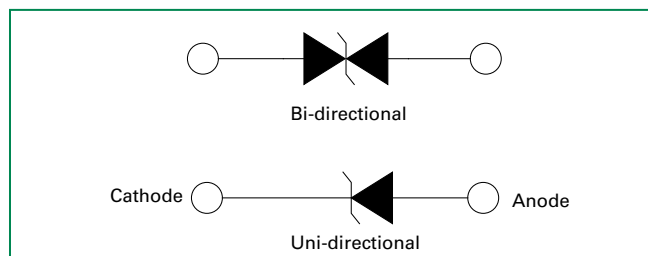

Description

The 5.0SMDJ series is designed specifically to protect sensitive electronic equipment from voltage transients induced by lightning and other transient voltage events.

Features

- For surface mounted applications to optimize board space
- Low profile package
- Typical failure mode is short from over-specified voltage or current
- Whisker test is conducted based on JEDEC JESD201A per its table 4a and 4c
- IEC-61000-4-2 ESD 15kV(Air), 8kV (Contact)
- ESD protection of data lines in accordance with IEC 61000-4-2 (IEC801-2)
- EFT protection of data lines in accordance with IEC 61000-4-4 (IEC801-4)
- Built-in strain relief
- V_{BR} @T_J = V_{BR} @25°C × (1 + αT × (T_J - 25)) (αT: Temperature Coefficient)
- Glass passivated chip junction
- 5000W peak pulse power capability at 10/1000µs waveform, repetition rate (duty cycles):0.01%
- Fast response time: typically less than 1.0ps from 0V to BV min
- Excellent clamping capability
- Low incremental surge resistance
- Typical I_R less than 5µA above 22V
- High temperature soldering guaranteed: 260°C/40 seconds at terminals
- Plastic package has underwriters laboratory flammability 94V-0
- Meet MSL level1, per J-STD-020, LF maximum peak of 260°C
- Matte tin lead-free plated
- Halogen free and RoHS compliant

Applications

TVS devices are ideal for the protection of I/O Interfaces, V_{CC} bus and other vulnerable circuits used in Telecom, Computer, Industrial and Consumer electronic applications.

Additional Information



[Datasheet](#)



[Resources](#)



[Samples](#)

Electrical Characteristics (T_A=25°C unless otherwise noted)

Part Number (Uni)	Part Number (Bi)	Marking		Reverse Stand off Voltage V _R (Volts)	Breakdown Voltage V _{BR} (Volts) @ I _T		Test Current I _T (mA)	Maximum Clamping Voltage V _C @ I _{pp} (V)	Maximum Peak Pulse Current I _{pp} (A)	Maximum Reverse Leakage I _R @ V _R (μA)	Agency Approval 
		UNI	BI		MIN	MAX					
5.0SMDJ12A	5.0SMDJ12CA	5PEP	5BEP	12.0	13.30	14.70	10	19.9	252.00	800	X
5.0SMDJ13A	5.0SMDJ13CA	5PEQ	5BEQ	13.0	14.40	15.90	10	21.5	233.00	500	X
5.0SMDJ14A	5.0SMDJ14CA	5PER	5BER	14.0	15.60	17.20	10	23.2	216.00	200	X
5.0SMDJ15A	5.0SMDJ15CA	5PES	5BES	15.0	16.70	18.50	1	24.4	205.00	100	X
5.0SMDJ16A	5.0SMDJ16CA	5PET	5BET	16.0	17.80	19.70	1	26.0	193.00	50	X
5.0SMDJ17A	5.0SMDJ17CA	5PEU	5BEU	17.0	18.90	20.90	1	27.6	181.00	20	X
5.0SMDJ18A	5.0SMDJ18CA	5PEV	5BEV	18.0	20.00	22.10	1	29.2	172.00	10	X
5.0SMDJ20A	5.0SMDJ20CA	5PEW	5BEW	20.0	22.20	24.50	1	32.4	155.00	5	X
5.0SMDJ22A	5.0SMDJ22CA	5PEX	5BEX	22.0	24.40	26.90	1	35.5	141.00	5	X
5.0SMDJ24A	5.0SMDJ24CA	5PEZ	5BEZ	24.0	26.70	29.50	1	38.9	129.00	5	X
5.0SMDJ26A	5.0SMDJ26CA	5PFE	5BFE	26.0	28.90	31.90	1	42.1	119.00	5	X
5.0SMDJ28A	5.0SMDJ28CA	5PFG	5BFG	28.0	31.10	34.40	1	45.4	110.00	5	X
5.0SMDJ30A	5.0SMDJ30CA	5PFG	5BFG	30.0	33.30	36.80	1	48.4	103.00	5	X
5.0SMDJ33A	5.0SMDJ33CA	5PFM	5BFM	33.0	36.70	40.60	1	53.3	93.90	5	X
5.0SMDJ36A	5.0SMDJ36CA	5PFP	5BFP	36.0	40.00	44.20	1	58.1	86.10	5	X
5.0SMDJ40A	5.0SMDJ40CA	5PFR	5BFR	40.0	44.40	49.10	1	64.5	77.60	5	X
5.0SMDJ43A	5.0SMDJ43CA	5PFT	5BFT	43.0	47.80	52.80	1	69.4	72.10	5	X
5.0SMDJ45A	5.0SMDJ45CA	5PFV	5BFV	45.0	50.00	55.30	1	72.7	68.80	5	X
5.0SMDJ48A	5.0SMDJ48CA	5PFX	5BFX	48.0	53.30	58.90	1	77.4	64.70	5	X
5.0SMDJ51A	5.0SMDJ51CA	5PFZ	5BFZ	51.0	56.70	62.70	1	82.4	60.70	5	X
5.0SMDJ54A	5.0SMDJ54CA	5PGE	5BGE	54.0	60.00	66.30	1	87.1	57.50	5	X
5.0SMDJ58A	5.0SMDJ58CA	5PGG	5BGG	58.0	64.40	71.20	1	93.6	53.50	5	X
5.0SMDJ60A	5.0SMDJ60CA	5PGK	5BGK	60.0	66.70	73.70	1	96.8	51.70	5	X
5.0SMDJ64A	5.0SMDJ64CA	5PGM	5BGM	64.0	71.10	78.60	1	103.0	48.60	5	X
5.0SMDJ70A	5.0SMDJ70CA	5PGP	5BGP	70.0	77.80	86.00	1	113.0	44.30	5	X
5.0SMDJ75A	5.0SMDJ75CA	5PGR	5BGR	75.0	83.30	92.10	1	121.0	41.40	5	X
5.0SMDJ78A	5.0SMDJ78CA	5PGT	5BGT	78.0	86.70	95.80	1	126.0	39.70	5	X
5.0SMDJ85A	5.0SMDJ85CA	5PGV	5BGV	85.0	94.40	104.00	1	137.0	36.50	5	X
5.0SMDJ90A	5.0SMDJ90CA	5PGX	5BGX	90.0	100.00	111.00	1	146.0	34.30	5	X
5.0SMDJ100A	5.0SMDJ100CA	5PGZ	5BGZ	100.0	111.00	123.00	1	162.0	30.90	5	X
5.0SMDJ110A	5.0SMDJ110CA	5PHE	5BHE	110.0	122.00	135.00	1	177.0	28.30	5	X
5.0SMDJ120A	5.0SMDJ120CA	5PHG	5BHG	120.0	133.00	147.00	1	193.0	26.00	5	X
5.0SMDJ130A	5.0SMDJ130CA	5PHK	5BHK	130.0	144.00	159.00	1	209.0	24.00	5	X
5.0SMDJ150A	5.0SMDJ150CA	5PHM	5BHM	150.0	167.00	185.00	1	243.0	20.60	5	X
5.0SMDJ160A	5.0SMDJ160CA	5PHP	5BHB	160.0	178.00	197.00	1	259.0	19.30	5	X
5.0SMDJ170A	5.0SMDJ170CA	5PHR	5BHR	170.0	189.00	209.00	1	275.0	18.20	5	X

For Bidirectional type having V_R of 20 volts and less, the I_R limit is double.
 For parts without A, the V_{BR} is + 10%, and V_C is 5% higher than A parts.

I-V Curve Characteristics

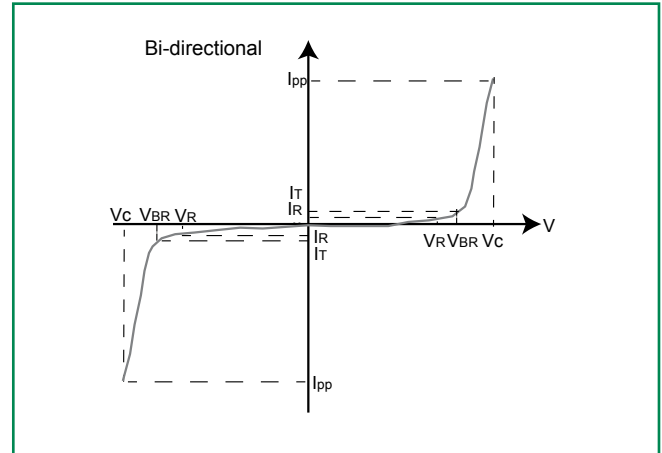
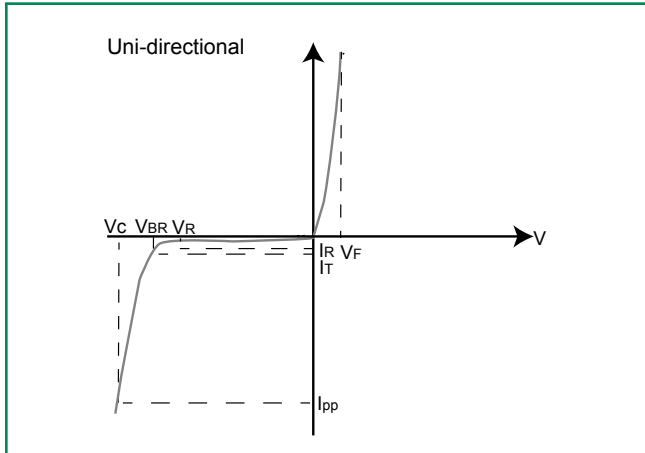

- P_{PPM} Peak Pulse Power Dissipation** – Max power dissipation
- V_R Stand-off Voltage** – Maximum voltage that can be applied to the TVS without operation
- V_{BR} Breakdown Voltage** – Maximum voltage that flows through the TVS at a specified test current (I_T)
- V_C Clamping Voltage** – Peak voltage measured across the suppressor at a specified I_{ppm} (peak impulse current)
- I_R Reverse Leakage Current** – Current measured at V_R
- V_F Forward Voltage Drop for Uni-directional**

Ratings and Characteristic Curves ($T_A=25^\circ\text{C}$ unless otherwise noted)

Figure 1 - TVS Transients Clamping Waveform

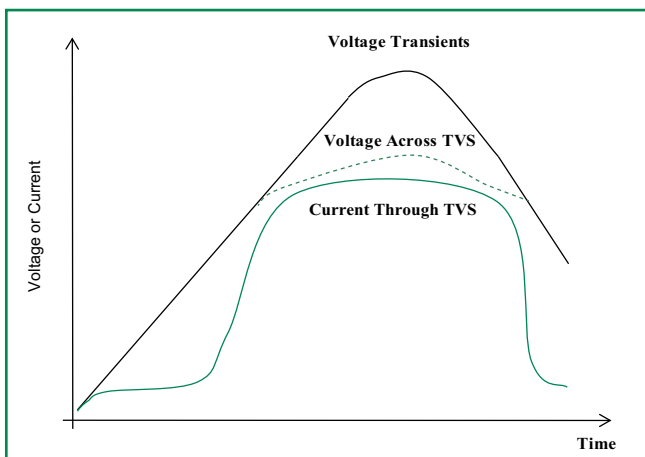
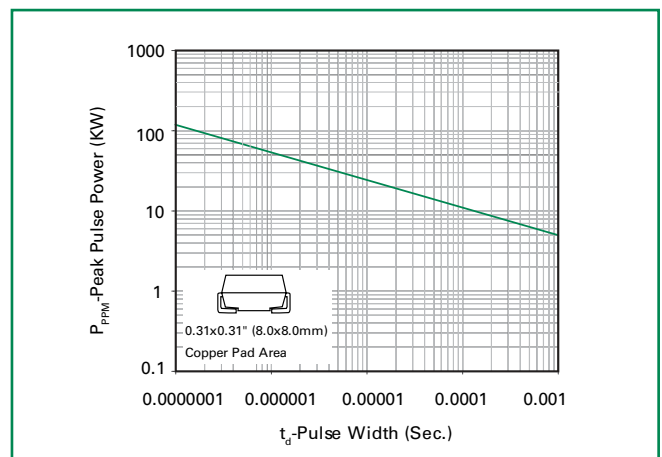

Figure 2 - Peak Pulse Power Rating



continues on next page.

Ratings and Characteristic Curves ($T_A=25^\circ\text{C}$ unless otherwise noted) (Continued)

Figure 3 - Peak Pulse Power or Current Derating Curve vs Initial Junction Temperature

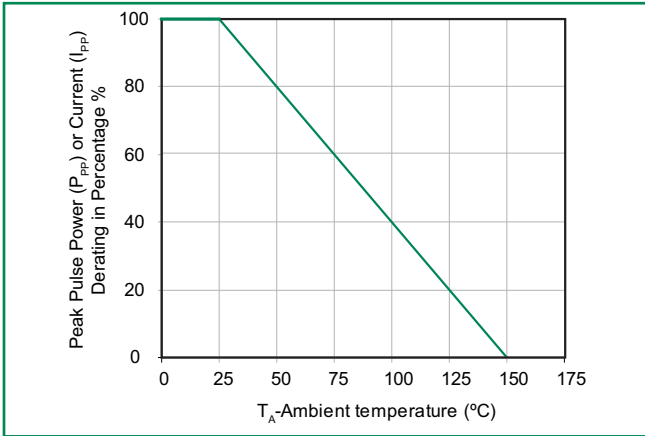

Figure 4 - Pulse Waveform

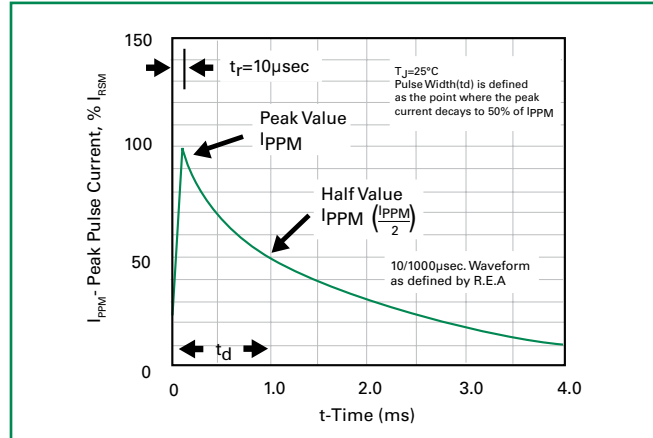

Figure 5 - Typical Junction Capacitance

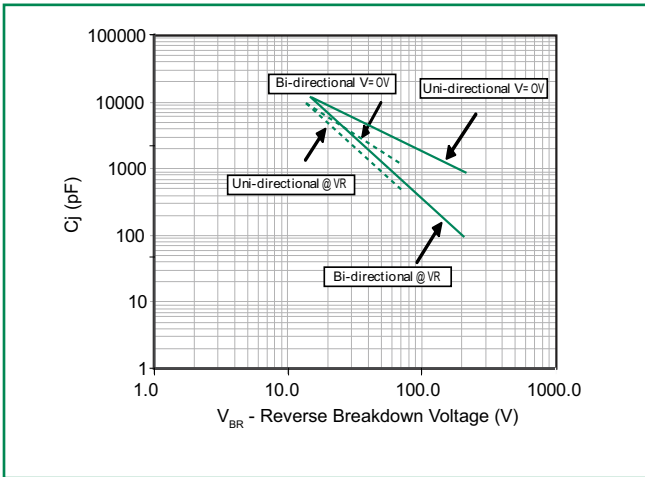

Figure 6 - Steady State Power Derating Curve

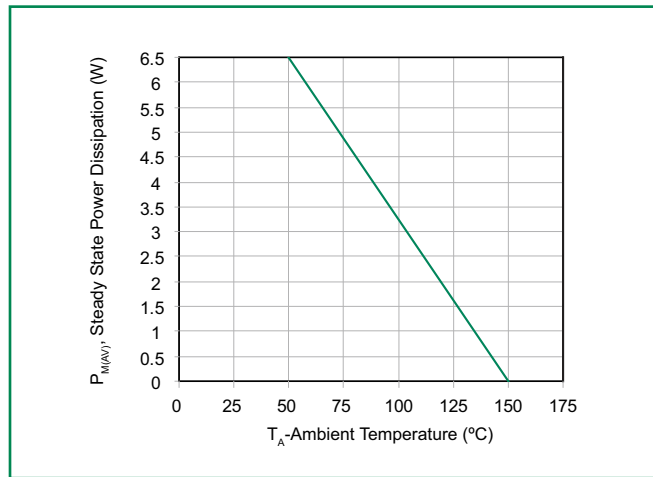
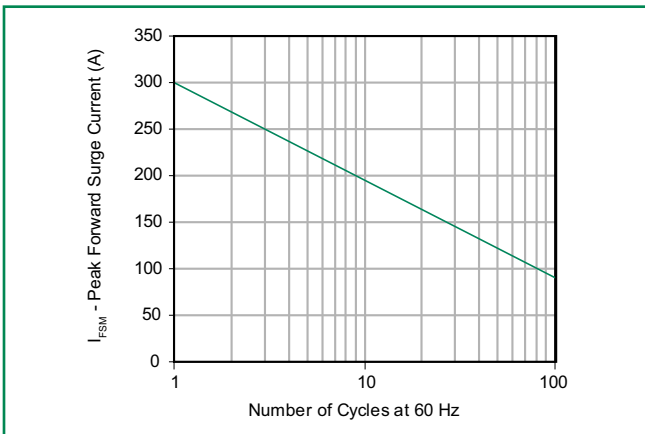
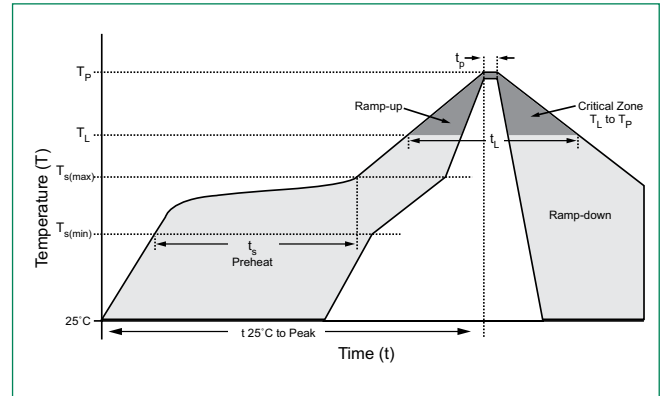

Figure 7 - Maximum Non-Repetitive Peak Forward Surge Current Uni-Directional Only



Soldering Parameters

Reflow Condition		Lead-free assembly
Pre Heat	- Temperature Min ($T_{s(min)}$)	150°C
	- Temperature Max ($T_{s(max)}$)	200°C
	- Time (min to max) (t_s)	60 – 180 secs
Average ramp up rate (Liquidus Temp (T_L) to peak)		3°C/second max
$T_{s(max)}$ to T_L - Ramp-up Rate		3°C/second max
Reflow	- Temperature (T_L) (Liquidus)	217°C
	- Time (min to max) (t_s)	60 – 150 seconds
Peak Temperature (T_p)		260 ^{+0/-5} °C
Time within 5°C of actual peak Temperature (t_p)		20 – 40 seconds
Ramp-down Rate		6°C/second max
Time 25°C to peak Temperature (T_p)		8 minutes Max.
Do not exceed		280°C



Physical Specifications

Weight	0.007 ounce, 0.21 grams
Case	JEDEC DO214AB. Molded plastic body over glass passivated junction
Polarity	Color band denotes positive end (cathode) except Bidirectional.
Terminal	Matte Tin-plated leads, Solderable per JESD22-B102

Environmental Specifications

High Temp. Storage	JESD22-A103
HTRB	JESD22-A108
Temperature Cycling	JESD22-A104
MSL	JEDEC-J-STD-020, Level 1
H3TRB	JESD22-A101
RSH	JESD22-B106

Dimensions

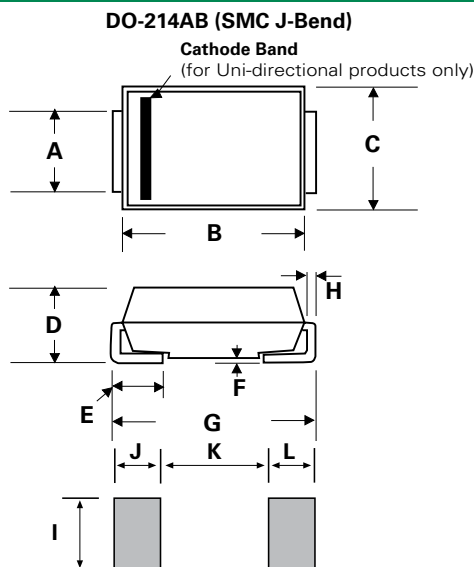

Dimensions	Inches		Millimeters	
	Min	Max	Min	Max
A	0.114	0.126	2.900	3.200
B	0.260	0.280	6.600	7.110
C	0.220	0.245	5.590	6.220
D	0.079	0.103	2.060	2.620
E	0.030	0.060	0.760	1.520
F	-	0.008	-	0.203
G	0.305	0.320	7.750	8.130
H	0.006	0.012	0.152	0.305
I	0.129	-	3.300	-
J	0.094	-	2.400	-
K	-	0.165	-	4.200
L	0.094	-	2.400	-

Part Numbering System

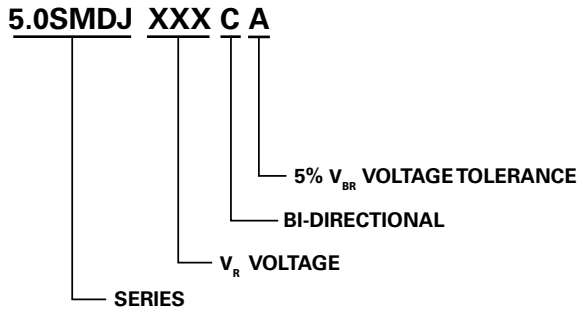

Part Marking System

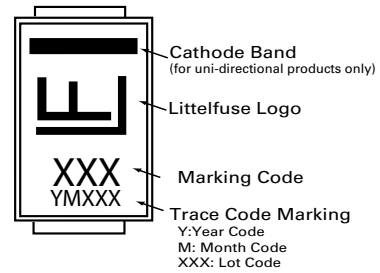

Packaging Options

Part number	Component Package	Quantity	Packaging Option	Packaging Specification
5.0SMDJxxxXX	DO-214AB	3000	Tape & Reel – 16mm/13" tape	EIA STD RS-481
5.0SMDJxxxXX-T7	DO-214AB	500	Tape & Reel – 16mm/7" tape	EIA STD RS-481

Tape and Reel Specification

