

RF Power Field Effect Transistors

N-Channel Enhancement-Mode Lateral MOSFETs

Designed for CDMA base station applications with frequencies from 1800 to 2200 MHz. Can be used in Class AB and Class C for all typical cellular base station modulation formats.

- Typical Doherty Single-Carrier W-CDMA Performance: $V_{DD} = 32$ Volts, $I_{DQA} = 150$ mA, $V_{GSB} = 1.5$ Vdc, $P_{out} = 10$ Watts Avg., IQ Magnitude Clipping, Channel Bandwidth = 3.84 MHz, Input Signal PAR = 9.9 dB @ 0.01% Probability on CCDF.

Frequency	G_{ps} (dB)	η_D (%)	Output PAR (dB)	ACPR (dBc)
2025 MHz	18.2	42.6	7.3	-34.8

- Capable of Handling 5:1 VSWR, @ 32 Vdc, 2017.5 MHz, 50 Watts CW (1) Output Power (3 dB Input Overdrive from Rated P_{out})
- Typical P_{out} @ 3 dB Compression Point \approx 50 Watts CW (1)

Features

- Production Tested in a Symmetrical Doherty Configuration
- 100% PAR Tested for Guaranteed Output Power Capability
- Characterized with Series Equivalent Large-Signal Impedance Parameters and Common Source S-Parameters
- Internally Matched for Ease of Use
- Integrated ESD Protection
- Greater Negative Gate-Source Voltage Range for Improved Class C Operation
- Designed for Digital Predistortion Error Correction Systems
- RoHS Compliant
- In Tape and Reel. R3 Suffix = 250 Units, 56 mm Tape Width, 13 inch Reel. For R5 Tape and Reel option, see p. 15.

Table 1. Maximum Ratings

Rating	Symbol	Value	Unit
Drain-Source Voltage	V_{DSS}	-0.5, +65	Vdc
Gate-Source Voltage	V_{GS}	-6.0, +10	Vdc
Operating Voltage	V_{DD}	32, +0	Vdc
Storage Temperature Range	T_{stg}	-65 to +150	°C
Case Operating Temperature	T_C	150	°C
Operating Junction Temperature (2,3)	T_J	225	°C
CW Operation @ $T_C = 25^\circ\text{C}$ Derate above 25°C	CW	42.4 0.17	W W/°C

Table 2. Thermal Characteristics

Characteristic	Symbol	Value (3,4)	Unit
Thermal Resistance, Junction to Case Case Temperature 78°C, 10 W CW, 32 Vdc, $I_{DQA} = 150$ mA, $V_{GSB} = 1.5$ Vdc, 2017.5 MHz Case Temperature 82°C, 40 W CW(1), 32 Vdc, $I_{DQA} = 150$ mA, $V_{GSB} = 1.5$ Vdc, 2017.5 MHz	$R_{\theta JC}$	2.11 1.50	°C/W

1. Exceeds recommended operating conditions. See CW operation data in Maximum Ratings table.
2. Continuous use at maximum temperature will affect MTTF.
3. MTTF calculator available at <http://www.freescale.com/rf>. Select Software & Tools/Development Tools/Calculators to access MTTF calculators by product.
4. Refer to AN1955, *Thermal Measurement Methodology of RF Power Amplifiers*. Go to <http://www.freescale.com/rf>. Select Documentation/-Application Notes - AN1955.

MRF7P20040HR3
MRF7P20040HSR3

2010-2025 MHz, 10 W AVG., 32 V
SINGLE W-CDMA
LATERAL N-CHANNEL
RF POWER MOSFETs

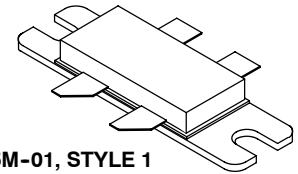

CASE 465M-01, STYLE 1
NI-780-4
MRF7P20040HR3

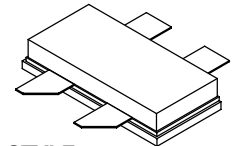

CASE 465H-02, STYLE 1
NI-780S-4
MRF7P20040HSR3

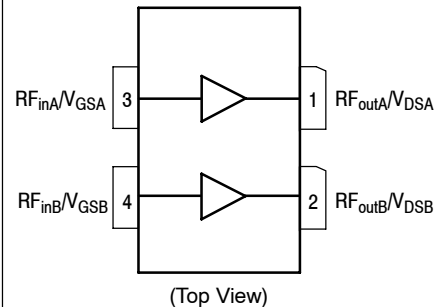

Figure 1. Pin Connections

Table 3. ESD Protection Characteristics

Test Methodology	Class
Human Body Model (per JESD22-A114)	1A (Minimum)
Machine Model (per EIA/JESD22-A115)	B (Minimum)
Charge Device Model (per JESD22-C101)	IV (Minimum)

Table 4. Electrical Characteristics ($T_A = 25^\circ\text{C}$ unless otherwise noted)

Characteristic	Symbol	Min	Typ	Max	Unit
Off Characteristics (1)					
Zero Gate Voltage Drain Leakage Current ($V_{DS} = 65\text{ Vdc}$, $V_{GS} = 0\text{ Vdc}$)	I_{DSS}	—	—	10	μAdc
Zero Gate Voltage Drain Leakage Current ($V_{DS} = 32\text{ Vdc}$, $V_{GS} = 0\text{ Vdc}$)	I_{DSS}	—	—	1	μAdc
Gate-Source Leakage Current ($V_{GS} = 5\text{ Vdc}$, $V_{DS} = 0\text{ Vdc}$)	I_{GSS}	—	—	1	μAdc

On Characteristics (1)

Gate Threshold Voltage ($V_{DS} = 10\text{ Vdc}$, $I_D = 33.5\ \mu\text{Adc}$)	$V_{GS(th)}$	1.2	2	2.7	Vdc
Gate Quiescent Voltage ($V_{DD} = 32\text{ Vdc}$, $I_{DA} = 150\text{ mAdc}$, Measured in Functional Test)	$V_{GS(Q)}$	2	2.7	3.5	Vdc
Drain-Source On-Voltage ($V_{GS} = 10\text{ Vdc}$, $I_D = 0.325\text{ Adc}$)	$V_{DS(on)}$	0.1	0.24	0.3	Vdc

Functional Tests (2,3) (In Freescale Doherty Test Fixture, 50 ohm system) $V_{DD} = 32\text{ Vdc}$, $I_{DQA} = 150\text{ mA}$, $V_{GSB} = 1.5\text{ Vdc}$, $P_{out} = 10\text{ W Avg.}$, $f = 2025\text{ MHz}$, Single-Carrier W-CDMA, IQ Magnitude Clipping, Input Signal PAR = 9.9 dB @ 0.01% Probability on CCDF. ACPR measured in 3.84 MHz Channel Bandwidth @ $\pm 5\text{ MHz}$ Offset.

Power Gain	G_{ps}	16	18.2	21	dB
Drain Efficiency	η_D	39	42.6	—	%
Output Peak-to-Average Ratio @ 0.01% Probability on CCDF	PAR	6.9	7.3	—	dB
Adjacent Channel Power Ratio	ACPR	—	-34.8	-30	dBc
Input Return Loss	IRL	—	-17.8	-10	dB

Typical Performance (3) (In Freescale Doherty Test Fixture, 50 ohm system) $V_{DD} = 32\text{ Vdc}$, $I_{DQA} = 150\text{ mA}$, $V_{GSB} = 1.5\text{ Vdc}$, 2010–2025 MHz Bandwidth

P_{out} @ 1 dB Compression Point, CW	P1dB	—	35	—	W
P_{out} @ 3 dB Compression Point, CW (4)	P3dB	—	50	—	W
IMD Symmetry @ 15 W PEP, P_{out} where IMD Third Order Intermodulation $\cong 30\text{ dBc}$ (Delta IMD Third Order Intermodulation between Upper and Lower Sidebands > 2 dB)	IMD _{sym}	—	8	—	MHz
VBW Resonance Point (IMD Third Order Intermodulation Inflection Point)	VBW _{res}	—	70	—	MHz
Gain Flatness in 15 MHz Bandwidth @ $P_{out} = 10\text{ W Avg.}$	G_F	—	0.04	—	dB
Gain Variation over Temperature (-30°C to $+85^\circ\text{C}$)	ΔG	—	0.013	—	dB/ $^\circ\text{C}$
Output Power Variation over Temperature (-30°C to $+85^\circ\text{C}$) (4)	$\Delta P1\text{dB}$	—	0.006	—	dB/ $^\circ\text{C}$

1. Each side of device measured separately.
2. Part internally matched both on input and output.
3. Measurement made with device in a Symmetrical Doherty configuration.
4. Exceeds recommended operating conditions. See CW operation data in Maximum Ratings table.

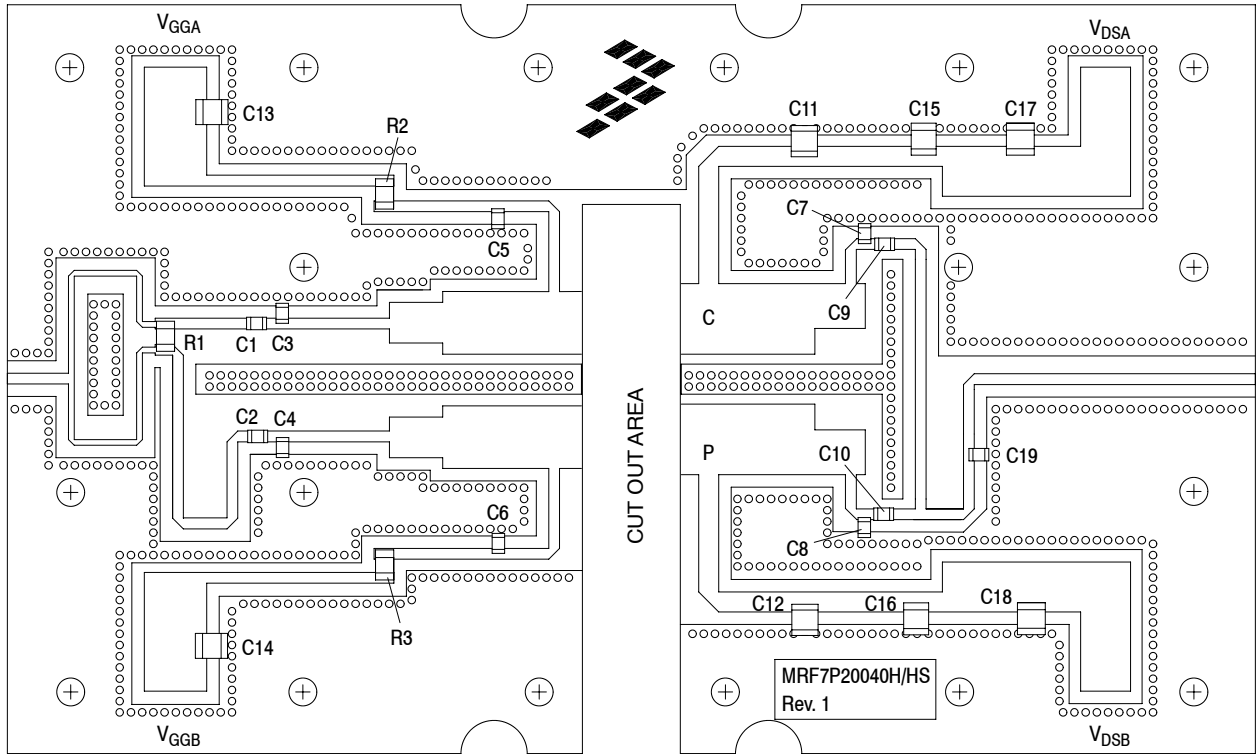

Figure 2. MRF7P20040HR3(HSR3) Test Circuit Component Layout

Table 5. MRF7P20040HR3(HSR3) Test Circuit Component Designations and Values

Part	Description	Part Number	Manufacturer
C1, C2, C9, C10	12 pF Chip Capacitors	ATC600F120FT250XT	ATC
C3, C4	2.4 pF Chip Capacitors	ATC600F2R4AT250XT	ATC
C5, C6	27 pF Chip Capacitors	ATC600F270FT250XT	ATC
C7, C8	1.1 pF Chip Capacitors	ATC600F1R1AT250XT	ATC
C11, C12	12 pF Chip Capacitors	ATC100B120FT1500XT	ATC
C13, C14	2.2 μ F, 50 V Chip Capacitors	C3225X7R1H225KT	TDK
C15, C16	4.7 μ F, 50 V Chip Capacitors	GRM43ER61H475MA88L	Murata
C17, C18	10 μ F, 50 V Chip Capacitors	GRM55DR61H106KA88L	Murata
C19	0.8 pF Chip Capacitor	ATC600F0R8AT250XT	ATC
R1	100 Ω , 1/4 W Chip Resistor	CRCW12061000FKEA	Vishay
R2, R3	12 Ω , 1/4 W Chip Resistors	CRCW120612R0FKEA	Vishay
PCB	0.020", $\epsilon_r = 3.5$	RO4350B	Rogers

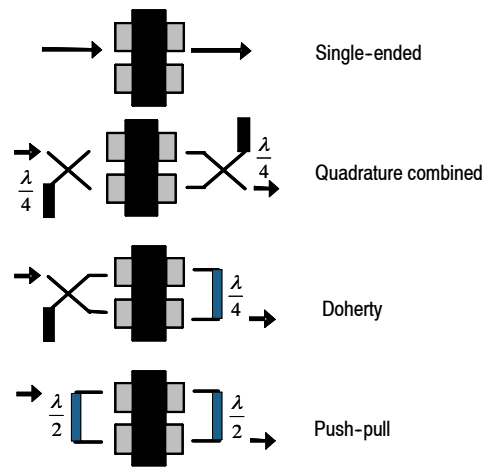

Figure 3. Possible Circuit Topologies

TYPICAL CHARACTERISTICS

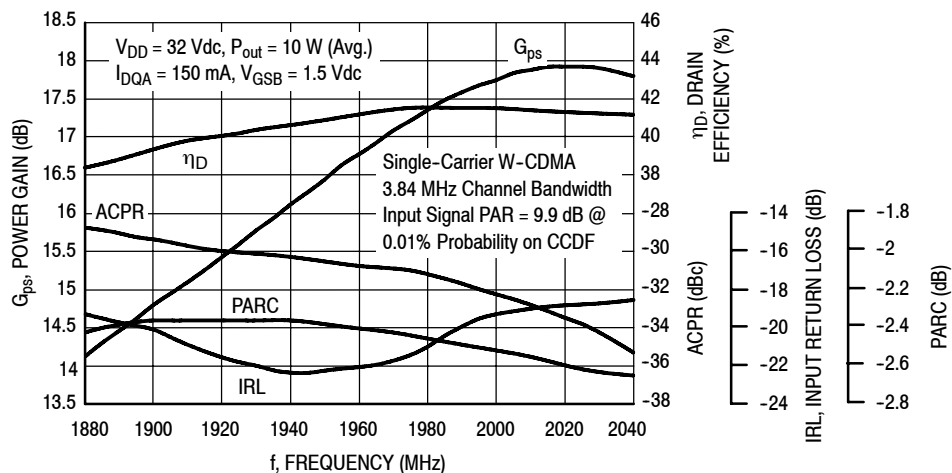

Figure 4. Output Peak-to-Average Ratio Compression (PARC) Broadband Performance @ $P_{out} = 10$ Watts Avg.

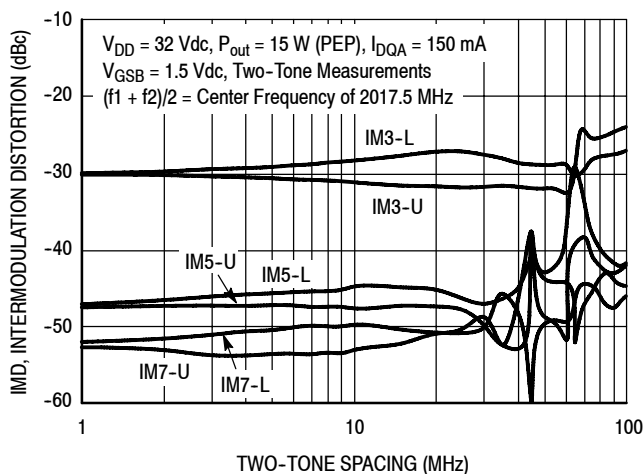

Figure 5. Intermodulation Distortion Products versus Two-Tone Spacing

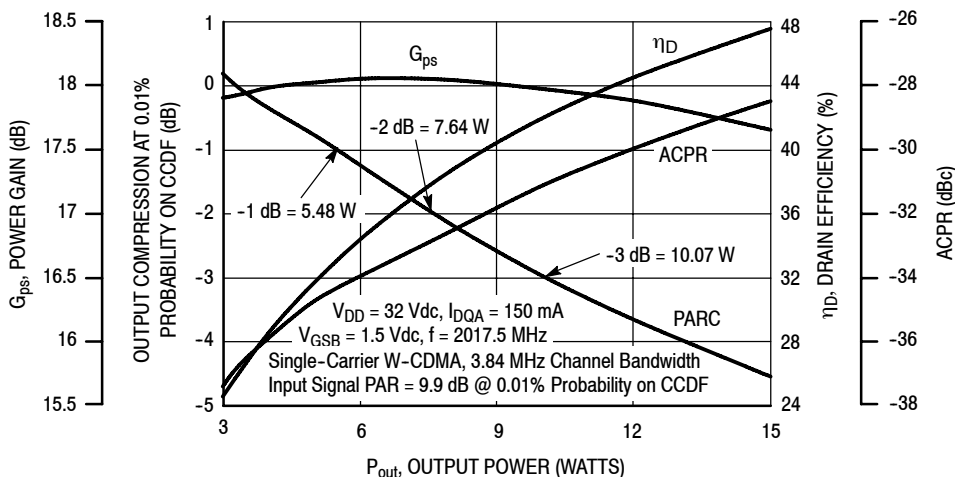

Figure 6. Output Peak-to-Average Ratio Compression (PARC) versus Output Power

TYPICAL CHARACTERISTICS

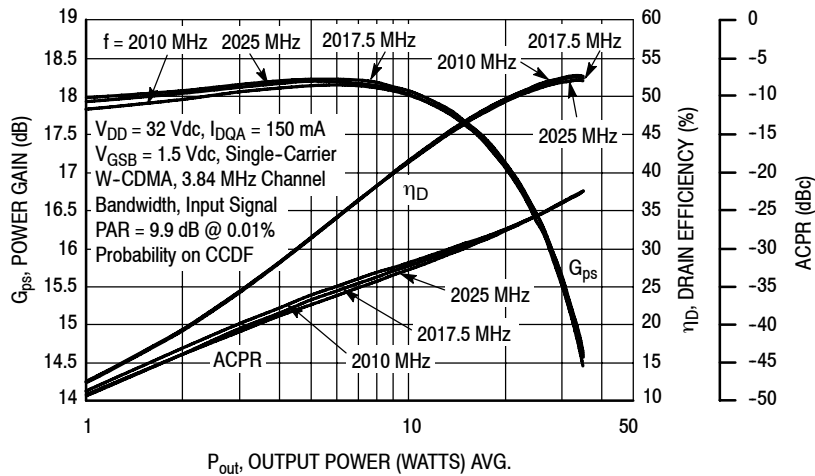

Figure 7. Single-Carrier W-CDMA Power Gain, Drain Efficiency and ACPR versus Output Power

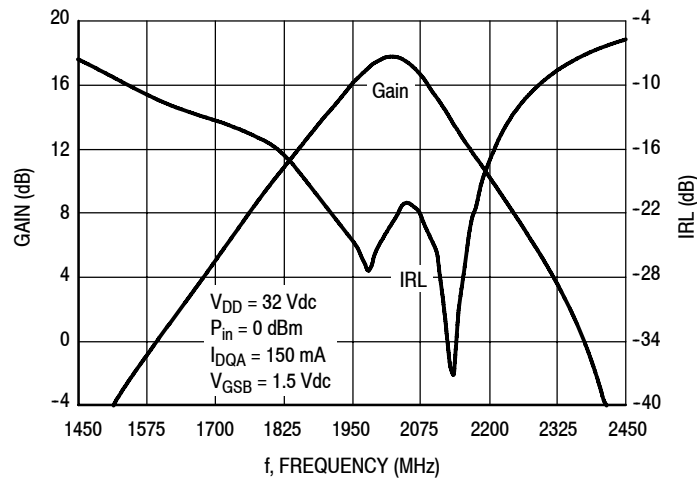

Figure 8. Broadband Frequency Response

W-CDMA TEST SIGNAL

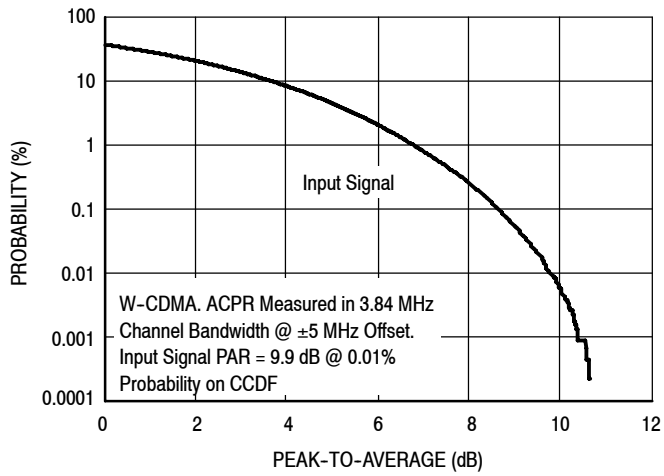

Figure 9. CCDF W-CDMA IQ Magnitude Clipping, Single-Carrier Test Signal

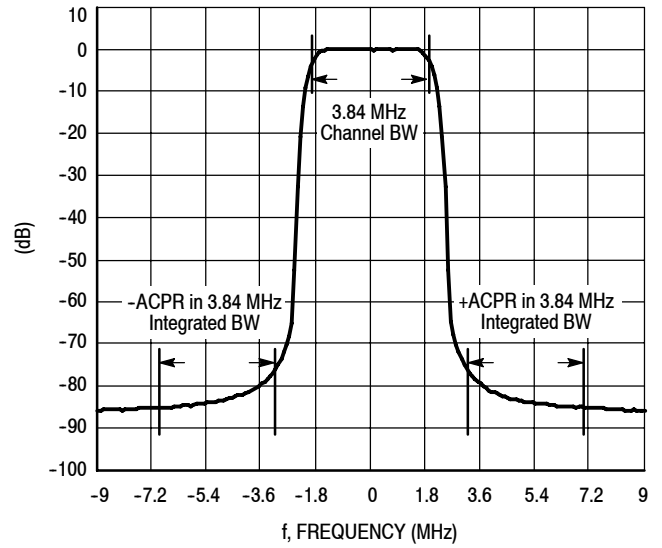

Figure 10. Single-Carrier W-CDMA Spectrum

$V_{DD} = 32 \text{ Vdc}$, $I_{DQA} = 150 \text{ mA}$, $V_{GSB} = 1.5 \text{ Vdc}$, $P_{out} = 10 \text{ W Avg.}$

f MHz	Z_{source} Ω	Z_{load} Ω
1995	6.80 - j13.11	14.67 + j4.09
2000	6.66 - j13.03	14.87 + j3.82
2005	6.52 - j12.93	15.08 + j3.58
2010	6.37 - j12.85	15.27 + j3.29
2015	6.22 - j12.78	15.45 + j3.00
2020	6.08 - j12.69	15.62 + j2.77
2025	5.94 - j12.60	15.80 + j2.44
2030	5.80 - j12.49	15.95 + j2.14
2035	5.65 - j12.40	16.08 + j1.82

Note: Measured with Peaking side open.

Z_{load} = Test circuit impedance as measured from drain to ground.

Z_{source} = Test circuit impedance as measured from gate to ground.

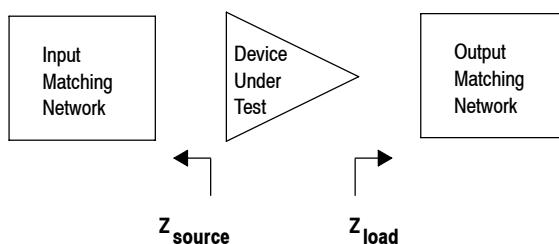

Figure 11. Series Equivalent Source and Load Impedance — Carrier Side

$V_{DD} = 32 \text{ Vdc}$, $I_{DQA} = 150 \text{ mA}$, $V_{GSB} = 1.5 \text{ Vdc}$, $P_{out} = 10 \text{ W Avg.}$

f MHz	Z_{source} Ω	Z_{load} Ω
1995	8.45 - j12.85	5.83 - j10.09
2000	8.28 - j12.79	5.57 - j10.11
2005	8.11 - j12.70	5.32 - j10.08
2010	7.95 - j12.63	5.06 - j10.07
2015	7.79 - j12.56	4.80 - j10.06
2020	7.63 - j12.48	4.55 - j10.01
2025	7.50 - j12.40	4.32 - j9.96
2030	7.34 - j12.32	4.06 - j9.88
2035	7.19 - j12.24	3.82 - j9.81

Note: Measured with Carrier side open.

Z_{load} = Test circuit impedance as measured from drain to ground.

Z_{source} = Test circuit impedance as measured from gate to ground.

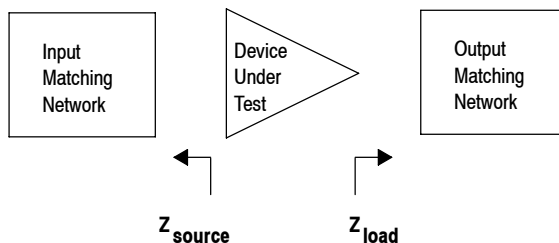
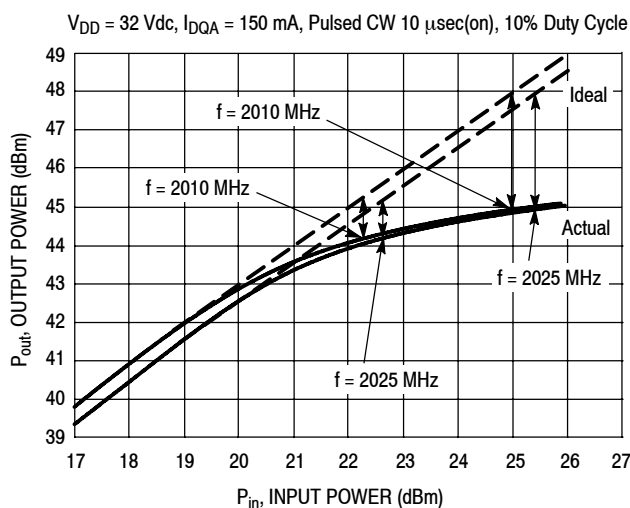

Figure 12. Series Equivalent Source and Load Impedance — Peaking Side

ALTERNATIVE PEAK TUNE LOAD PULL CHARACTERISTICS



f (MHz)	P1dB		P3dB	
	Watts	dBm	Watts	dBm
2010	26	44.1	31	44.9
2025	26	44.2	31	44.9

Test Impedances per Compression Level

f (MHz)		Z_{source} Ω	Z_{load} Ω
2010	P1dB	$2.49 - j18.56$	$15.82 - j0.28$
2025	P1dB	$2.66 - j19.78$	$15.78 + j0.52$

Figure 13. Pulsed CW Output Power versus Input Power @ 32 V

NOTE: Measurement made on the Class AB, carrier side of the device.

$V_{DD} = 28 \text{ Vdc}$, $I_{DQA} = 150 \text{ mA}$

f MHz	Max P_{out} ⁽¹⁾		Z_{source} Ω	Z_{load} Ω
	Watts	dBm		
1805	35	45.4	2.2 - j9.3	17.1 - j7.9
1880	35	45.5	2.3 - j11.3	14.0 - j4.2
1930	35	45.5	2.4 - j13.0	14.7 - j5.9
2025	35	45.5	3.5 - j17.3	15.5 - j8.0
2110	34	45.3	3.8 - j20.6	15.4 - j9.3
2200	35	45.5	5.6 - j25.8	14.4 - j9.4

(1) Maximum output power measurement reflects pulsed 3 dB gain compression.

Z_{source} = Test circuit impedance as measured from gate contact to ground.

Z_{load} = Test circuit impedance as measured from drain contact to ground.

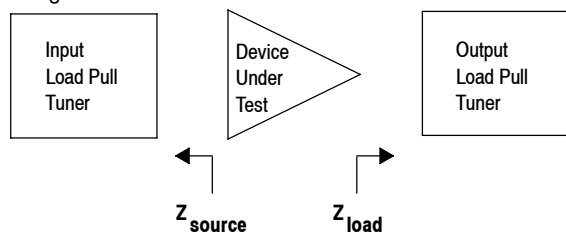

Figure 14. Carrier Side Load Pull Performance — Maximum P3dB Tuning

$V_{DD} = 28 \text{ Vdc}$, $I_{DQA} = 150 \text{ mA}$

f MHz	Max Eff. ⁽¹⁾ %	Z_{source} Ω	Z_{load} Ω
1805	66.6	2.2 - j9.3	17.6 + j9.5
1880	70.1	2.3 - j11.3	16.1 + j9.8
1930	69.8	2.4 - j13.0	14.2 + j8.9
2025	67.7	3.5 - j17.3	13.8 + j6.2
2110	67.9	3.8 - j20.6	11.5 + j3.9
2200	70.3	5.6 - j25.8	9.6 - j0.6

(1) Maximum efficiency measurement reflects pulsed 3 dB gain compression.

Z_{source} = Test circuit impedance as measured from gate contact to ground.

Z_{load} = Test circuit impedance as measured from drain contact to ground.

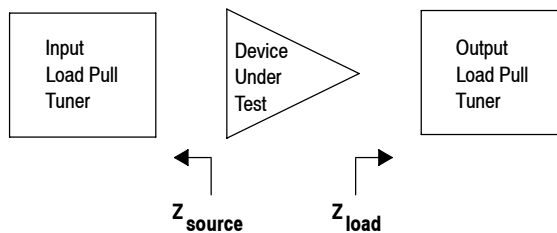
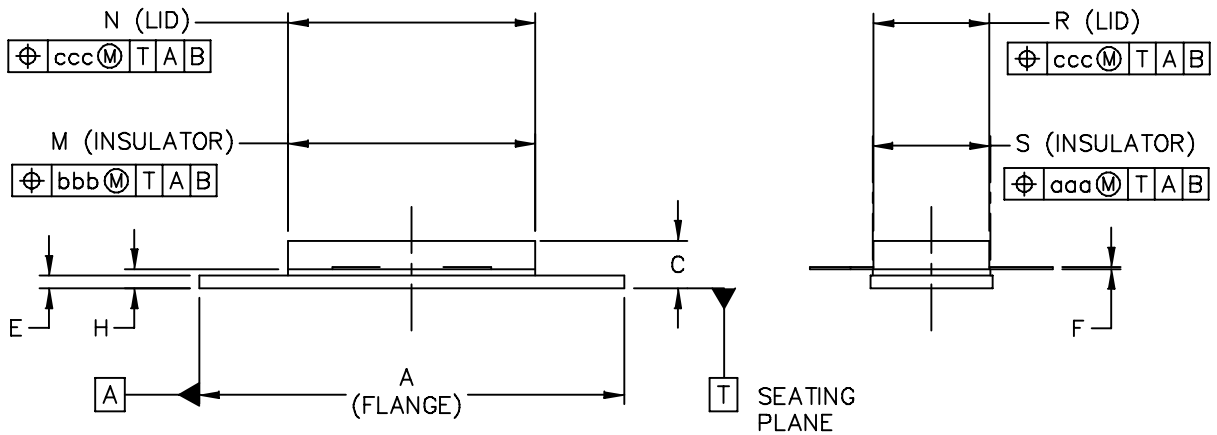
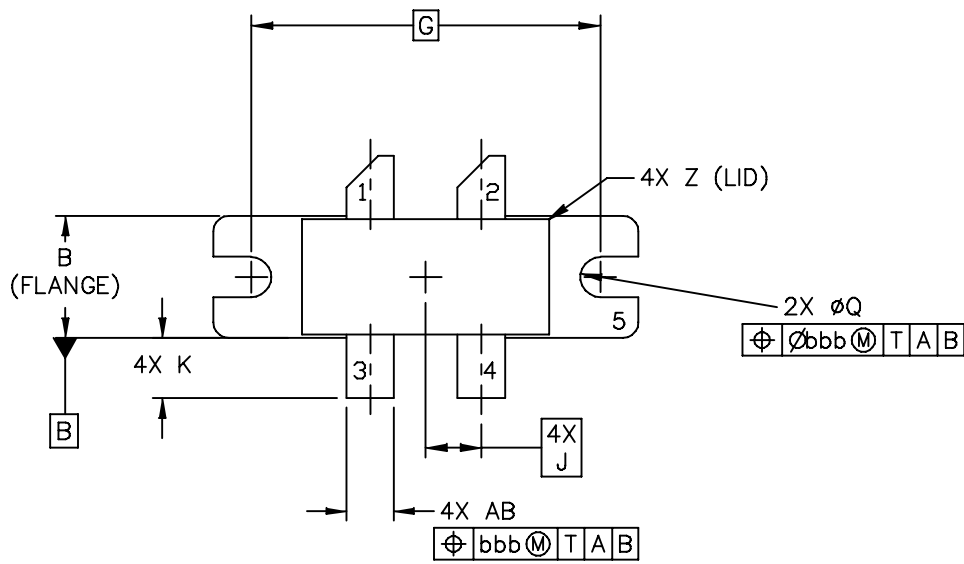

Figure 15. Carrier Side Load Pull Performance — Maximum Efficiency Tuning

PACKAGE DIMENSIONS



© FREESCALE SEMICONDUCTOR, INC. ALL RIGHTS RESERVED.	MECHANICAL OUTLINE	PRINT VERSION NOT TO SCALE	
TITLE: NI 780-4	DOCUMENT NO: 98ASA10793D CASE NUMBER: 465M-01 STANDARD: NON-JEDEC	REV: 0 27 MAR 2007	

NOTES:

1. DIMENSIONING AND TOLERANCING PER ANSI Y14.5M-1994.
2. CONTROLLING DIMENSION: INCH.
3. DIMENSION H IS MEASURED .030 (0.762) AWAY FROM PACKAGE BODY.

STYLE 1:

- PIN 1. DRAIN
 2. DRAIN
 3. GATE
 4. GATE
 5. SOURCE

DIM	INCH		MILLIMETER		DIM	INCH		MILLIMETER	
	MIN	MAX	MIN	MAX		MIN	MAX	MIN	MAX
A	1.335	1.345	33.91	34.16	R	.365	.375	9.27	9.53
B	.380	.390	9.65	9.91	S	.365	.375	9.27	9.52
C	.125	.170	3.18	4.32	U		.040		1.02
E	.035	.045	0.89	1.14	Z		.030		0.76
F	.003	.006	0.08	0.15	AB	.145	.155	3.68	3.94
G	1.100 BSC		27.94 BSC						
H	.057	.067	1.45	1.7	aaa		.005		0.127
J	.175 BSC		4.44 BSC		bbb		.010		0.254
K	.170	.210	4.32	5.33	ccc		.015		0.381
M	.774	.786	19.61	20.02					
N	.772	.788	19.61	20.02					
Q	Ø.118	Ø.138	Ø3	Ø3.51					
© FREESCALE SEMICONDUCTOR, INC. ALL RIGHTS RESERVED.			MECHANICAL OUTLINE			PRINT VERSION NOT TO SCALE			
TITLE: NI 780-4					DOCUMENT NO: 98ASA10793D			REV: 0	
					CASE NUMBER: 465M-01			27 MAR 2007	
					STANDARD: NON-JEDEC				

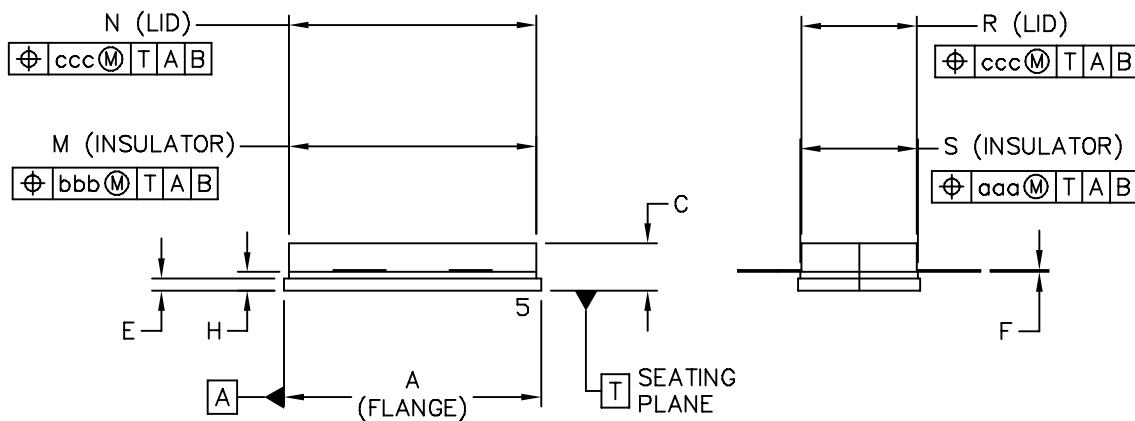
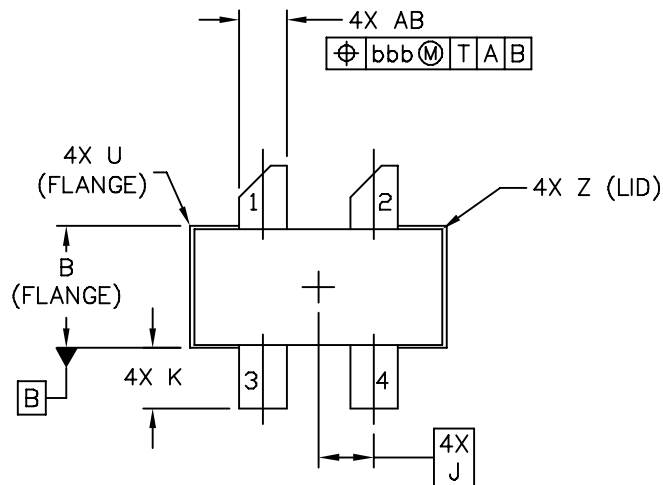

© FREESCALE SEMICONDUCTOR, INC. ALL RIGHTS RESERVED.	MECHANICAL OUTLINE	PRINT VERSION NOT TO SCALE	
TITLE: NI 780S-4	DOCUMENT NO: 98ASA10718D	REV: A	
	CASE NUMBER: 465H-02	27 MAR 2007	
	STANDARD: NON-JEDEC		

NOTES:

1. DIMENSIONING AND TOLERANCING PER ANSI Y14.5M-1994.
2. CONTROLLING DIMENSION: INCH.
3. DELETED
4. DIMENSION H IS MEASURED .030 (0.762) AWAY FROM PACKAGE BODY.

STYLE 1:

- PIN 1. DRAIN
- 2. DRAIN
- 3. GATE
- 4. GATE
- 5. SOURCE

DIM	INCH		MILLIMETER		DIM	INCH		MILLIMETER	
	MIN	MAX	MIN	MAX		MIN	MAX	MIN	MAX
A	.805	.815	20.45	20.7	U		.040		1.02
B	.380	.390	9.65	9.91	Z		.030		0.76
C	.125	.170	3.18	4.32	AB	.145	.155	3.68	- 3.94
E	.035	.045	0.89	1.14					
F	.003	.006	0.08	0.15	aaa		.005		0.127
H	.057	.067	1.45	1.7	bbb		.010		0.254
J	.175 BSC		4.44 BSC		ccc		.015		0.381
K	.170	.210	4.32	5.33					
M	.774	.786	19.61	20.02					
N	.772	.788	19.61	20.02					
R	.365	.375	9.27	9.53					
S	.365	.375	9.27	9.52					
© FREESCALE SEMICONDUCTOR, INC. ALL RIGHTS RESERVED.			MECHANICAL OUTLINE			PRINT VERSION NOT TO SCALE			
TITLE: NI 780S-4					DOCUMENT NO: 98ASA10718D			REV: A	
					CASE NUMBER: 465H-02			27 MAR 2007	
					STANDARD: NON-JEDEC				

PRODUCT DOCUMENTATION, TOOLS AND SOFTWARE

Refer to the following documents, tools and software to aid your design process.

Application Notes

- AN1955: Thermal Measurement Methodology of RF Power Amplifiers

Engineering Bulletins

- EB212: Using Data Sheet Impedances for RF LDMOS Devices

Software

- Electromigration MTTF Calculator
- RF High Power Model
- .s2p File

For Software and Tools, do a Part Number search at <http://www.freescale.com>, and select the “Part Number” link. Go to the Software & Tools tab on the part’s Product Summary page to download the respective tool.

R5 TAPE AND REEL OPTION

R5 Suffix = 50 Units, 56 mm Tape Width, 13 inch Reel.

The R5 tape and reel option for MRF7P20040H and MRF7P20040HS parts will be available for 2 years after release of MRF7P20040H and MRF7P20040HS. Freescale Semiconductor, Inc. reserves the right to limit the quantities that will be delivered in the R5 tape and reel option. At the end of the 2 year period customers who have purchased these devices in the R5 tape and reel option will be offered MRF7P20040H and MRF7P20040HS in the R3 tape and reel option.

REVISION HISTORY

The following table summarizes revisions to this document.

Revision	Date	Description
0	June 2009	<ul style="list-style-type: none">• Initial Release of Data Sheet
1	Aug. 2009	<ul style="list-style-type: none">• Removed IQ Magnitude Clipping from Typical Performance bullet, p. 1 and Functional Test header, p. 2• Electrical Characteristics, DC tests: updated footnote to indicate each side of device measured separately, p. 2
2	Dec. 2010	<ul style="list-style-type: none">• Updated frequency in overview paragraph from “2010 to 2025 MHz” to “1800 to 2200 MHz” per expanded load pull characterization shown in Fig. 14, Carrier Side Load Pull Performance — Maximum P3dB Tuning and Fig. 15, Carrier Side Load Pull Performance — Maximum Efficiency Tuning, p. 1• Added CW Operation information to Maximum Ratings table, p. 1• In Table 2, Thermal Characteristics, $P_{out} = 10$ W CW thermal resistance values changed from $I_{DQA} 2.5/V_{GSB} 2.9$ to 2.11 °C/W and $P_{out} = 40$ W CW thermal resistance value changed from 2.3 to 1.50 °C/W. Thermal values now reflect the use of the combined dissipated power from the carrier amplifier and peaking amplifier, p. 1• Added Fig. 14, Carrier Side Load Pull Performance — Maximum P3dB Tuning and Fig. 15, Carrier Side Load Pull Performance — Maximum Efficiency Tuning to show load pull data for expanded frequency range presented in p. 1 overview paragraph, p. 10

How to Reach Us:

Home Page:

www.freescale.com

Web Support:

<http://www.freescale.com/support>

USA/Europe or Locations Not Listed:

Freescale Semiconductor, Inc.
Technical Information Center, EL516
2100 East Elliot Road
Tempe, Arizona 85284
1-800-521-6274 or +1-480-768-2130
www.freescale.com/support

Europe, Middle East, and Africa:

Freescale Halbleiter Deutschland GmbH
Technical Information Center
Schatzbogen 7
81829 Muenchen, Germany
+44 1296 380 456 (English)
+46 8 52200080 (English)
+49 89 92103 559 (German)
+33 1 69 35 48 48 (French)
www.freescale.com/support

Japan:

Freescale Semiconductor Japan Ltd.
Headquarters
ARCO Tower 15F
1-8-1, Shimo-Meguro, Meguro-ku,
Tokyo 153-0064
Japan
0120 191014 or +81 3 5437 9125
support.japan@freescale.com

Asia/Pacific:

Freescale Semiconductor China Ltd.
Exchange Building 23F
No. 118 Jianguo Road
Chaoyang District
Beijing 100022
China
+86 10 5879 8000
support.asia@freescale.com

For Literature Requests Only:

Freescale Semiconductor Literature Distribution Center
1-800-441-2447 or +1-303-675-2140
Fax: +1-303-675-2150
LDCForFreescaleSemiconductor@hibbertgroup.com

Information in this document is provided solely to enable system and software implementers to use Freescale Semiconductor products. There are no express or implied copyright licenses granted hereunder to design or fabricate any integrated circuits or integrated circuits based on the information in this document.

Freescale Semiconductor reserves the right to make changes without further notice to any products herein. Freescale Semiconductor makes no warranty, representation or guarantee regarding the suitability of its products for any particular purpose, nor does Freescale Semiconductor assume any liability arising out of the application or use of any product or circuit, and specifically disclaims any and all liability, including without limitation consequential or incidental damages. "Typical" parameters that may be provided in Freescale Semiconductor data sheets and/or specifications can and do vary in different applications and actual performance may vary over time. All operating parameters, including "Typicals", must be validated for each customer application by customer's technical experts. Freescale Semiconductor does not convey any license under its patent rights nor the rights of others. Freescale Semiconductor products are not designed, intended, or authorized for use as components in systems intended for surgical implant into the body, or other applications intended to support or sustain life, or for any other application in which the failure of the Freescale Semiconductor product could create a situation where personal injury or death may occur. Should Buyer purchase or use Freescale Semiconductor products for any such unintended or unauthorized application, Buyer shall indemnify and hold Freescale Semiconductor and its officers, employees, subsidiaries, affiliates, and distributors harmless against all claims, costs, damages, and expenses, and reasonable attorney fees arising out of, directly or indirectly, any claim of personal injury or death associated with such unintended or unauthorized use, even if such claim alleges that Freescale Semiconductor was negligent regarding the design or manufacture of the part.

Freescale™ and the Freescale logo are trademarks of Freescale Semiconductor, Inc. All other product or service names are the property of their respective owners.

© Freescale Semiconductor, Inc. 2009-2010. All rights reserved.

