

3-phase WYE RFI Power Line Filters for High Noise Applications

AYC Series



UL Recognized*



150AYC10B

AYC Series

- For 3-phase, four wire, WYE applications
- Very high attenuation
- Low leakage current
- Ideal for EMC troubleshooting and refurbishing in the field
- Touch safe terminals provide easy connections and prevent inadvertent contact for safety in the most demanding applications

Ordering Information

150 AYC 10 B -95

Terminal Block Option
-95 - 95mm terminal block
available on 150A only
Omit for standard terminals

Filter Type
B - Single stage

Input / Output Style
10 - Terminal block

AYC Series

Current Rating
16, 25, 36, 63, 80, 110,
150, 180 or 200A

Available Part Numbers

| | |
|----------|--------------|
| 16AYC10B | 110AYC10B |
| 25AYC10B | 150AYC10B |
| 36AYC10B | 150AYC10B-95 |
| 63AYC10B | 180AYC10B |
| 80AYC10B | 200AYC10B |

Specifications

Maximum leakage current each Line to Ground:

| | 120 VAC 60Hz | 277 VAC 50Hz |
|----------------|--------------|--------------|
| 16A | 62 mA | 106 mA |
| 25 & 36A | 68 mA | 118 mA |
| 63A | 74 mA | 128 mA |
| 80, 100 & 150A | 74 mA | 129 mA |
| 180, 200A | 111 mA | 192 mA |

Hipot rating (one minute):

| | |
|------------------|----------|
| Line to Ground: | 1850 VDC |
| Line to Line: | 1850 VDC |
| Line to Neutral: | 1450 VDC |

Rated Voltage (max):

| | |
|------------------|---------|
| Phase to Phase: | 480 VAC |
| Phase to Ground: | 277 VAC |

Operating Frequency:

50/60 Hz

Rated Current:

16 to 200A

Operating Ambient Temperature Range (at rated current I_r):

-10°C to +40°C
In an ambient temperature (T_a) higher than +40°C the maximum operating current (I_o) is calculated as follows: $I_o = I_r \sqrt{(85-T_a)/45}$

Electrical Schematic

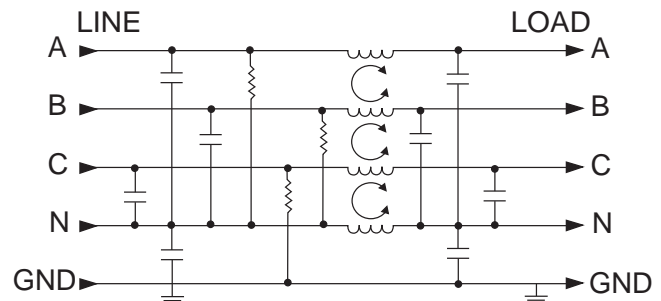

*All except 200AYC10B

3-phase WYE RFI Filters for High Noise Applications *(continued)*

AYC Series

Case Styles

16, 25, 36, 63AYC10B



80, 110, 150AYC10B / -95



180, 200AYC10B

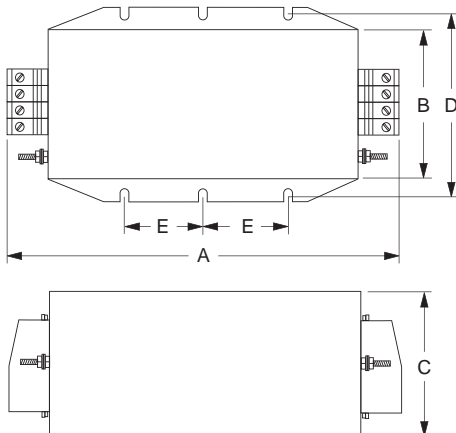

Case Dimensions

| Part No. | A (max.) | B (max.) | C (max.) | D (max.) | E ± 0.078 $\pm .2$ |
|------------------------|-----------------------|----------------------|----------------------|----------------------|------------------------------|
| 16AYC10B | 6.69 170.0 | 4.37 111.0 | 2.56 65.0 | 4.92 125.0 | 2.76 70.0 |
| 25AYC10B | 9.96 246.0 | 5.08 129.0 | 2.52 64.0 | 5.71 145.0 | 4.53 115.0 |
| 36AYC10B | 10.35 263.0 | 5.08 129.0 | 2.52 64.0 | 5.71 145.0 | 4.53 115.0 |
| 63AYC10B | 10.98 279.0 | 5.08 129.0 | 2.95 75.0 | 5.71 145.0 | 4.53 115.0 |
| 80, 110 & 150AYC10B | 12.09 307.0 | 5.55 141.0 | 5.55 141.0 | 6.10 155.0 | 4.53 115.0 |
| 150AYC10B-95 | 12.59 320.0 | 5.55 141.0 | 5.55 141.0 | 6.10 155.0 | 4.53 115.0 |
| 180AYC10B | 15.71 | 5.55 | 5.55 | 6.10 | 3.25 |
| 200AYC10B | 399.0 | 141.0 | 141.0 | 155.0 | 82.5 |

Terminals

| Part No. | Terminal | Size | Torque max. lbf-in [N·m] |
|---|-------------|-------------------------------------|-----------------------------|
| 16AYC10B | Ground | M5 | 26.58 [3.0] |
| | Line / Load | 4mm ² terminal block | 7.08 [0.8] |
| 25AYC10B | Ground | M5 | 26.58 [3.0] |
| | Line / Load | 6mm ² terminal block | 15.93 [7.8] |
| 36AYC10B | Ground | M5 | 26.58 [3.0] |
| | Line / Load | 10mm ² terminal block | 15.93 [7.8] |
| 63AYC10B | Ground | M6 | 53.1 [6.0] |
| | Line / Load | 16mm ² terminal block | 20.35 [2.3] |
| 80, 110, 150AYC10B | Ground | M10 | 177.0 [20.0] |
| | Line / Load | 50mm ² terminal block | 70.80 [8.0] |
| 150AYC10B-95 180AYC10B 200AYC10B | Ground | M10 | 177.0 [20.0] |
| | Line / Load | 95mm ² terminal block | 177.0 [20.0] |

3-phase WYE RFI Filters for High Noise Applications *(continued)*

AYC Series

Performance Data

Typical Insertion Loss

Measured in closed 50 Ohm system

16AYC10B

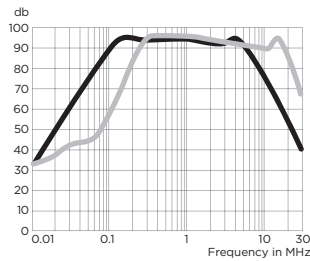

25AYC10B

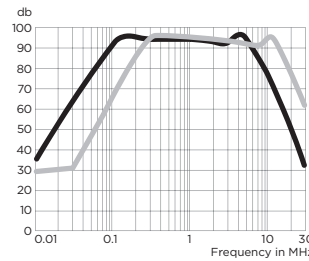

36AYC10B

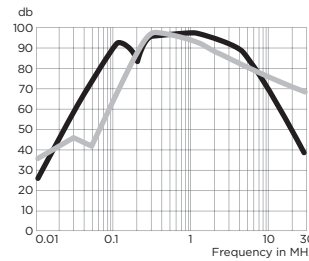

63AYC10B

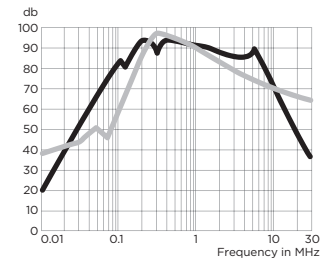

80AYC10B

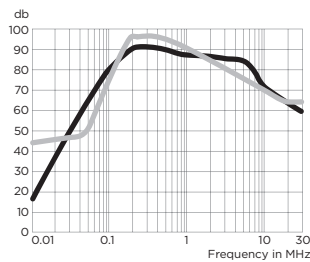

110AYC10B

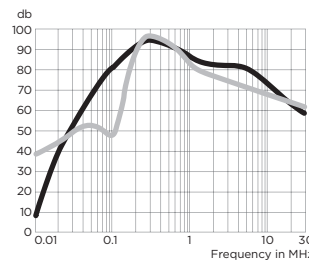

150AYC10B

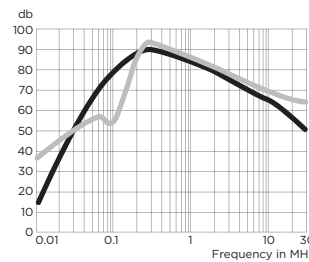

180, 200AYC10B

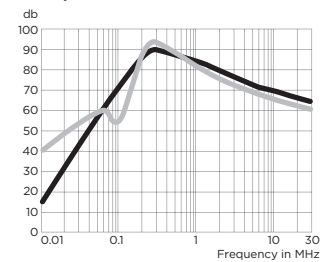

— Common Mode / Asymmetrical (L-G)
— Differential Mode / Symmetrical (L-L)

Minimum Insertion Loss

Measured in closed 50 Ohm system

Common Mode / Asymmetrical (Line to Ground)

| Part No. | Frequency –MHz | | | | | | | |
|----------------|----------------|-----|----|----|----|----|----|----|
| | .01 | .05 | .1 | .5 | 1 | 5 | 10 | 30 |
| 16AYC10B | 23 | 66 | 82 | 88 | 82 | 79 | 55 | 21 |
| 25AYC10B | 26 | 68 | 83 | 93 | 88 | 68 | 45 | 4 |
| 36AYC10B | 18 | 61 | 78 | 96 | 91 | 71 | 49 | 7 |
| 63AYC10B | 11 | 57 | 72 | 90 | 86 | 68 | 44 | 4 |
| 80AYC10B | 10 | 57 | 75 | 84 | 77 | 75 | 62 | 45 |
| 110AYC10B | 10 | 51 | 60 | 88 | 84 | 74 | 50 | 12 |
| 150AYC10B | - | 50 | 57 | 82 | 79 | 75 | 51 | 7 |
| 150AYC10B-95 | 1 | 51 | 55 | 85 | 82 | 84 | 51 | 11 |
| 180, 200AYC10B | 3 | 53 | 55 | 97 | 89 | 81 | 56 | 20 |

Differential Mode / Symmetrical (Line to Line)

| Part No. | Frequency –MHz | | | | | | | |
|----------------|----------------|-----|----|-----|----|----|----|----|
| | .01 | .05 | .1 | .5 | 1 | 5 | 10 | 30 |
| 16AYC10B | 21 | 32 | 54 | 90 | 86 | 73 | 72 | 47 |
| 25AYC10B | 23 | 33 | 60 | 100 | 95 | 87 | 70 | 38 |
| 36AYC10B | 25 | 37 | 51 | 94 | 87 | 69 | 58 | 17 |
| 63AYC10B | 27 | 45 | 41 | 84 | 77 | 63 | 61 | 43 |
| 80AYC10B | 37 | 42 | 67 | 87 | 80 | 66 | 60 | 50 |
| 110AYC10B | 27 | 35 | 39 | 75 | 72 | 51 | 44 | 31 |
| 150AYC10B | 28 | 37 | 42 | 74 | 67 | 52 | 45 | 30 |
| 150AYC10B-95 | 28 | 40 | 42 | 73 | 66 | 51 | 44 | 31 |
| 180, 200AYC10B | 30 | 41 | 50 | 70 | 64 | 49 | 42 | 26 |