

DESCRIPTION

The DIP series is a very compact design having a low profile package and a high profile package. This series is compatible with all DIP relays.



FEATURES

- High resistance option available
- Diode option available

CHARACTERISTICS

- Low profile package
- Standard pin configurations
- IC-pin compatible
- 4.25 kVDC breakdown voltage for pin out 13
- UL approval

DIMENSIONS

All dimensions in mm [inch]

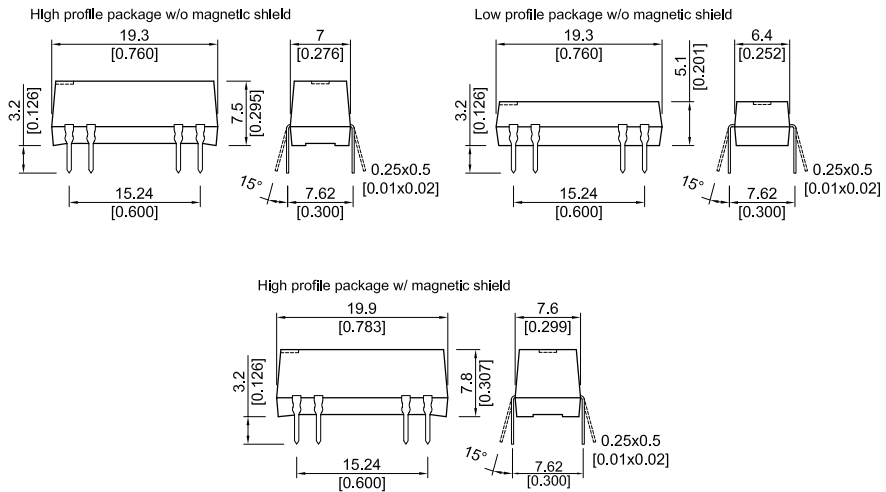

Molded DIP Reed Relays

ORDER INFORMATION

Series	Nominal Voltage	Contact Form	Switch Model	Pin Out	Option () Version with magn. Shield
DIP	XX -	XX	XX -	XX	X
Options	05, 12, 15, 24	1A	72, 75	10, 11, 12, 13*	A, B, C, L(M), D(Q), E(R), F(S)
		1B	72	13*, 19	
		2A	72	21	
	05, 12, 15, 24	1C	90	51	

*Selects 4-25 (3.0 kVRMS) breakdown voltage contact to coil.

Part Number Example

DIP12 - 1A75 - 13L

12 is the nominal voltage
1A is the contact form
75 is the switch model
13 is the pin out
L is the option

PIN OUT

View from top of component, 2.54 mm [0.10"] pitch grid

10

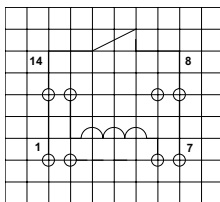

11

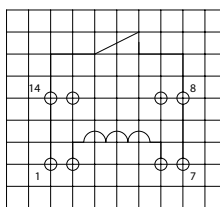

12

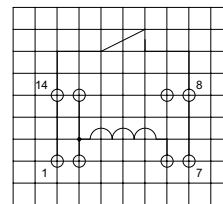

13

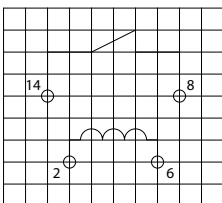

19

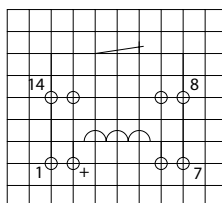

21

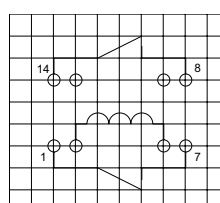

51

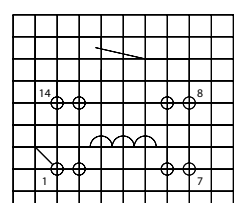

OPTIONS

() Versions with magnetic shield, View from top of component, 2.54 mm [0.10"] pitch grid

A

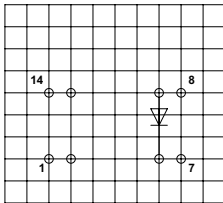

B

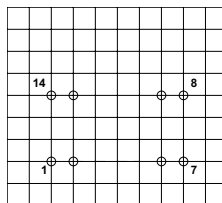

C

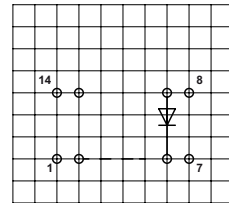

L (M)

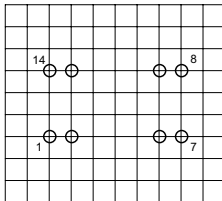

D (Q)

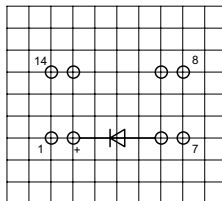

E (R)

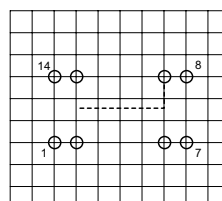

F (S)

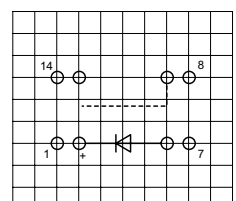

OPTIONS DEPENDENCE ON CASE SIZES

Contact Form	Package Size	Pin Out	Options												
			L	A	B	C	D	E	F	M	Q	R	S		
1A	Low Profile	10	X	X	X	X									
		11	X					X							
		12	X	X											
		13	X												
	High Profile	10				X									
		11					X		X	X	X			X	
		12					X	X	X						
13					X			X	X						
1B	High Profile	19	X				X			X	X				
2A	High Profile	21	X	X			X	X	X	X	X	X	X	X	
1C	Low Profile	51	X												
	High Profile						X	X	X	X	X	X	X	X	

- L = No option
- A = Diode between Pin 6 and Pin 9 (Pin 6 is positive)
- B = Internal shield on Pin 2.
- C = Diode between Pin 6 and Pin 9 (Pin 6 is positive and internal shield on Pin 2)
- D = With Diode between pin 2 and 6 (Pin 2 is positive)
- E = Internal shield on pin 9

- F = With Diode between pin 2 and 6 (Pin 2 is positive) and Internal shield on pin 9
- M = External magnetic shield
- Q = External magnetic shield and diode between pin 2 and 6 (Pin 2 is positive)
- R = External magnetic shield and internal shield on pin 9
- S = External magnetic shield and with diode between pin 2 and 6 (Pin 2 is positive) and internal shield on pin 9

Molded DIP Reed Relays

RELAY DATA

All Data at 20° C	Switch Model → Contact Form →	Switch 72 Form A / B			Switch 75 Form A			Switch 90 Form C			Unit
		Min.	Typ.	Max.	Min.	Typ.	Max.	Min.	Typ.	Max.	
Contact Ratings	Conditions										
Switching Power	Any DC combination of V & A not to exceed their individual max.'s			10			10			10	W
Switching Voltage	DC or peak AC			200			500			100	V
Switching Current	DC or peak AC			0.5			0.5			0.2	A
Carry Current	DC or peak AC			1.0			1.0			0.5	A
Static Contact Resistance	w/ 0.5 V & 10mA			150			200			150	mΩ
Dynamic Contact Resistance	Measured w/ 0.5 V & 50mA , 1.5 ms after closure			200			200			200	mΩ
Insulation Resistance across Contacts	100 volts applied	10 ¹² 10 ¹²			10 ¹² 10 ¹²			10 ⁹ 10 ¹²			Ω
Breakdown Voltage across Contact	Across contacts Contact to coil	500 1500**			1500* 1500**			150 1500			VDC
Operate Time incl. Bounce	Measured w/ 100 % overdrive			0.5			0.5			2.0	ms
Release Time	Measured w/ no coil suppression			0.1			0.1			2.0	ms
Capacitance	at 10 kHz cross contact		0.2 2.0			0.4 2.0			1.5 0.3		pF
Life Expectancies											
Switching 5 V - 10 mA	DC only & <10 pF stray cap.		1000			500			100		10 ⁶ Cycles
For other load requirements, see the life test section on P. 120.											
Environmental Data											
Shock Resistance	1/2 sinus wave duration 11 ms			50			50			50	g
Vibration Resistance	From 10 - 2000 Hz			20			20			20	g
Ambient Temperature	10°C/ minute max. allowable	-20		70	-20		70	-20		70	°C
Stock Temperature	10°C/ minute max. allowable	-35		95	-35		95	-35		95	°C
Soldering Temperature	5 sec.			260			260			260	°C
* 600 VDC with 5V coil, 1000 VDC with 12V coil. ** Selects Pin out 13 and 425 kVDC (3.0 kVRMS) breakdown voltage contact to coil.											

COIL DATA

Contact Form	Switch Model	Coil Voltage		Coil Resistance			Pull-in Voltage	Drop-out Voltage	Nominal Coil Power
All Data at 20 °C		VDC		Ω			VDC	VDC	mW
		Nom.	Max.	Min.	Typ.	Max.	Max.	Min.	Typ.
1A	72 75	5	7.5	450 (180)	500 (200)	550 (220)	3.5	0.75	50
		12	16	900	1000	1100	8.4	1.8	145
		15	20	1800	2000	2200	10.5	2.2	115
		24	30	1800	2000	2200	16.8	3.6	290
1B **	72	5	7.5	450	500	550	3.5	0.75	50
		12	16	900	1000	1100	8.4	1.8	145
		15	20	1800	2000	2200	10.5	2.2	115
		24	30	1800	2000	2200	16.8	3.6	290
2A	72	5	7.5	180	200	220	3.5	0.75	125
		12	16	450	500	550	8.4	1.8	290
		15	20	1800	2000	2200	10.5	2.2	115
		24	30	1800	2000	2200	16.8	3.6	290
1C	90	5	7.5	180	200	220	3.5	0.75	125
		12	16	450	500	550	8.4	1.8	290
		15	20	1800	2000	2200	10.5	2.2	115
		24	30	1800	2000	2200	16.8	3.6	290

() For Switch 75.
 * The pull-in / drop-out voltage and coil resistance will change at rate of 0.4% per °C.
 ** Re-closure of Form B may occur if the max. coil voltage is exceeded. Coil polarity on Form B must be observed. Pin 2 is positive.