



SAF7113H

9-bit video input processor

Rev. 03 — 9 May 2005

Product data sheet

1. General description

The 9-bit video input processor is a combination of a two-channel analog preprocessing circuit including source selection, anti-aliasing filter and ADC, an automatic clamp and gain control, a Clock Generation Circuit (CGC), a digital multistandard decoder (PAL BGHI, PAL M, PAL N, combination PAL N, NTSC M, NTSC-Japan, NTSC N and SECAM), a brightness, contrast and saturation control circuit, a multistandard VBI data slicer and a 27 MHz VBI data bypass.

The pure 3.3 V CMOS circuit SAF7113H, analog front-end and digital video decoder, is a highly integrated circuit for desktop video applications. The decoder is based on the principle of line-locked clock decoding and is able to decode the color of PAL, SECAM and NTSC signals into ITU-R BT 601 compatible color component values. The SAF7113H accepts as analog inputs CVBS or S-video (Y/C) from TV or VTR sources. The circuit is I²C-bus controlled.

The integrated high performance multistandard data slicer supports several VBI data standards:

- Teletext 625 lines: WST (World Standard Teletext) and CCST (Chinese teletext)
- Teletext 525 lines: US-WST, NABTS (North-American Broadcast Text System) and MOJI (Japanese teletext)
- Closed caption: Europe and US (line 21)
- Wide Screen Signalling (WSS)
- Video Programming Signal (VPS)
- Time codes (VITC EBU/SMPTE)
- High-speed VBI data bypass for Intericast application.

2. Features

- Four analog inputs, internal analog source selectors, e.g. 4 × CVBS or 2 × Y/C or (1 × Y/C and 2 × CVBS)
- Two analog preprocessing channels in differential CMOS style for best S/N-performance
- Fully programmable static gain or automatic gain control for the selected CVBS or Y/C channel
- Switchable white peak control
- Two built-in analog anti-aliasing filters
- Two 9-bit video CMOS Analog-to-Digital Converters (ADCs), digitized CVBS or Y/C-signals are available on the VPO-port via I²C-bus control
- On-chip clock generator

PHILIPS

- Line-locked system clock frequencies
- Digital PLL for horizontal sync processing and clock generation, horizontal and vertical sync detection
- Requires only one crystal (24.576 MHz) for all standards
- Automatic detection of 50 Hz and 60 Hz field frequency and automatic switching between PAL and NTSC standards
- Luminance and chrominance signal processing for PAL BGHI, PAL N, combination PAL N, PAL M, NTSC M, NTSC N, NTSC 4.43, NTSC-Japan and SECAM
- User programmable luminance peaking or aperture correction
- Cross-color reduction for NTSC by chrominance comb filtering
- PAL delay line for correcting PAL phase errors
- Brightness Contrast Saturation (BCS) and hue control on-chip
- Real-time status information output (RTCO)
- Two multifunctional real-time output pins controlled by I²C-bus
- Multistandard VBI data slicer decoding World Standard Teletext (WST), North-American Broadcast Text System (NABTS), closed caption, Wide Screen Signalling (WSS), Video Programming System (VPS), Vertical Interval Time Code (VITC) variants (EBU/SMPTE), etc.
- Standard ITU-R BT 656 YUV 4 : 2 : 2 format (8-bit) on VPO output bus
- Enhanced ITU-R BT 656 output format on VPO output bus containing:
 - ◆ Active video
 - ◆ Raw CVBS data for Intercast applications (27 MHz data rate)
 - ◆ Decoded VBI data
- Boundary scan test circuit complies with the "IEEE Std. 1149.b1 - 1994" (ID-Code = 1 7113 02B)
- I²C-bus controlled (full read-back ability by an external controller and bit rate up to 400 kbit/s)
- Low power (< 0.5 W), low voltage (3.3 V), small package (QFP44)
- Power saving mode by chip enable input
- Detection of copy protected input signals according to the Macrovision standard; can be used to prevent unauthorized recording of pay-TV or video tape signals.

3. Applications

- Notebook (low power consumption)
- PCMCIA card application
- AGP based graphics cards
- Image processing
- Video phone applications
- Intercast and PC teletext applications
- Security applications.

4. Quick reference data

Table 1: Quick reference data

Symbol	Parameter	Conditions	Min	Typ	Max	Unit
V _{DDD}	digital supply voltage		3.0	3.3	3.6	V
V _{DDA}	analog supply voltage		3.1	3.3	3.5	V
T _{amb}	ambient temperature		-40	+25	+85	°C
P _{A+D}	analog plus digital power dissipation		-	0.34	-	W

5. Ordering information

Table 2: Ordering information

Type number	Package		
	Name	Description	Version
SAF7113H	QFP44	plastic quad flat package; 44 leads (lead length 1.3 mm); body 10 × 10 × 1.75 mm	SOT307-2

6. Block diagram

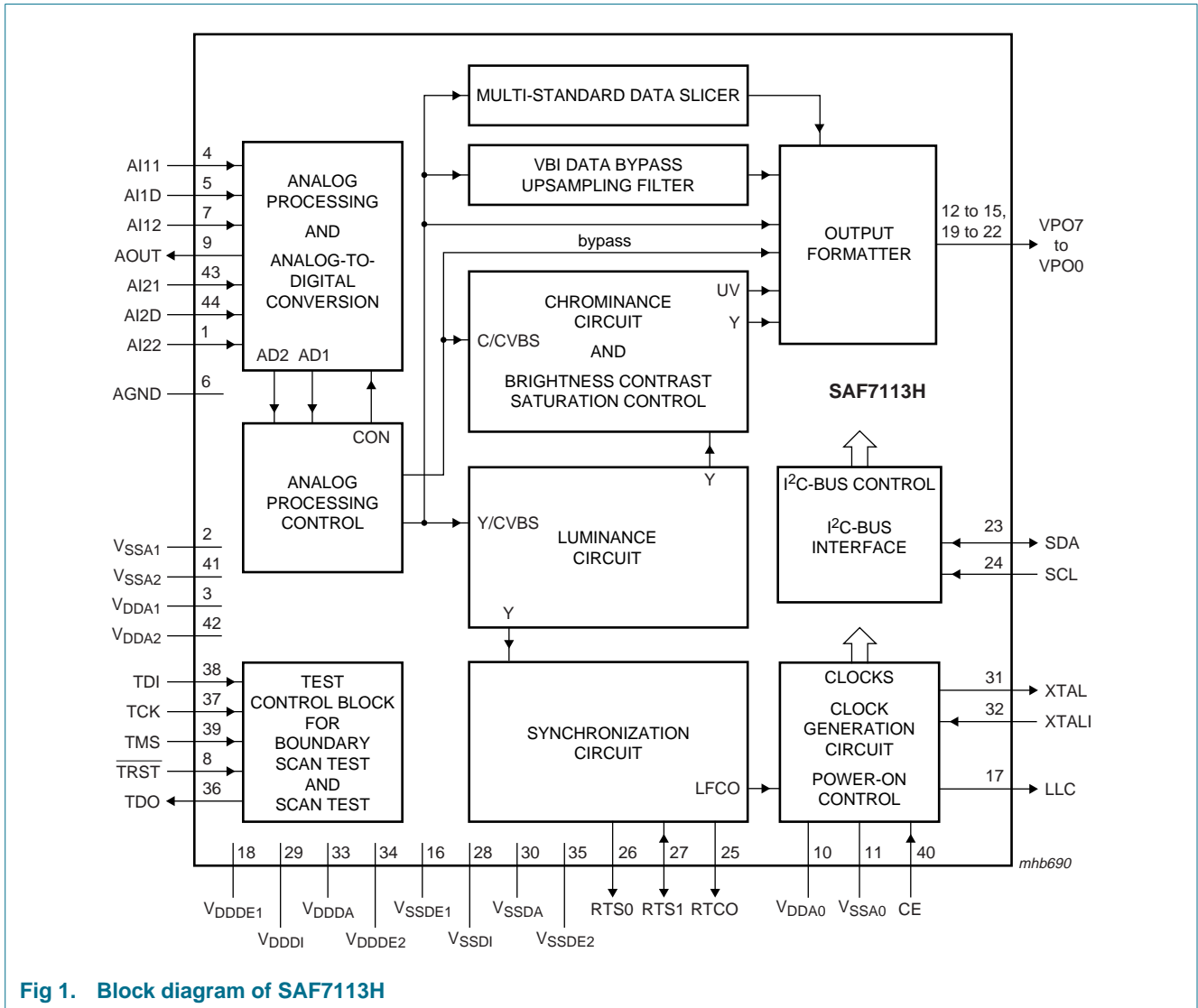

Fig 1. Block diagram of SAF7113H

7. Pinning information

7.1 Pinning

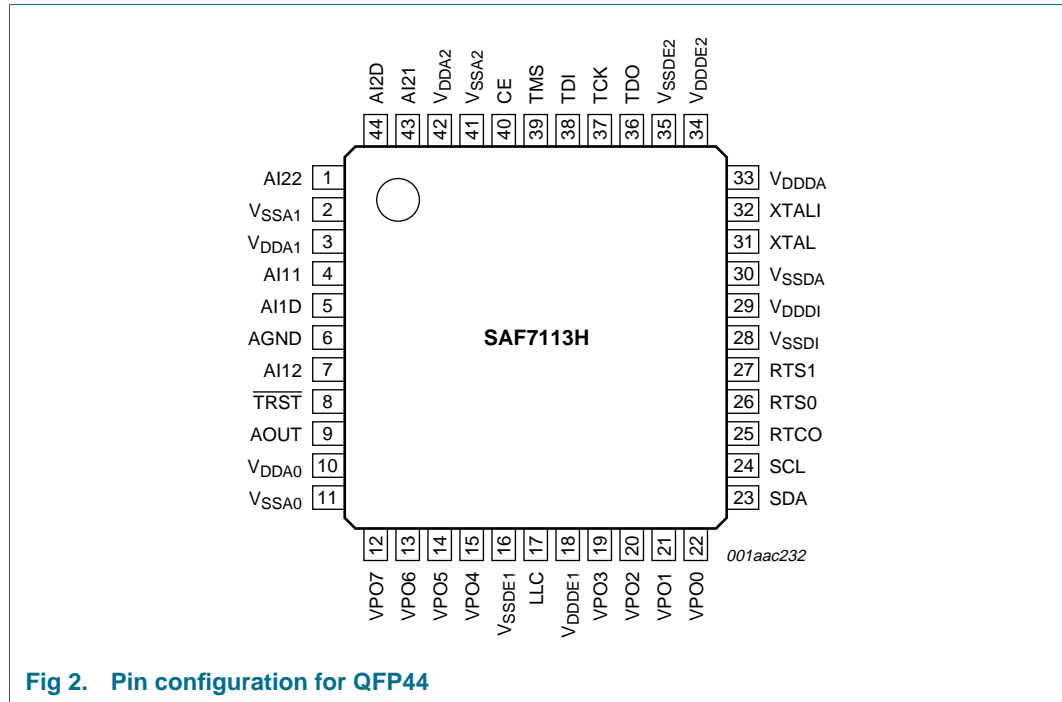

Fig 2. Pin configuration for QFP44

7.2 Pin description

Table 3: Pin description

Symbol	Pin	Type	Description
AI22	1	I	analog input 22
VSSA1	2	P	ground for analog supply voltage channel 1
VDDA1	3	P	positive supply voltage for analog channel 1 (3.3 V)
AI11	4	I	analog input 11
AI1D	5	I	differential analog input for AI11 and AI12; has to be connected to ground via a capacitor; see application diagram of Figure 40
AGND	6	P	analog signal ground connection
AI12	7	I	analog input 12
TRST	8	I	test reset input (active LOW), for boundary scan test; see Table note 1 , Table note 2 and Table note 3
AOUT	9	O	analog test output; for testing the analog input channels; 75 Ω termination possible
VDDA0	10	P	positive supply voltage (3.3 V) for internal Clock Generation Circuit (CGC)
VSSA0	11	P	ground for internal clock generation circuit

Table 3: Pin description...continued

Symbol	Pin	Type	Description
VPO7 to VPO4	12 to 15	O	digital VPO-bus output signal; higher bits of the 8-bit output bus. The output data types of the VPO-bus are controlled via I ² C-bus registers LCR2 to LCR24 (see Table 7). If I ² C-bus bit VIPB = 1, the higher bits of the digitized input signal are connected to these outputs, configured by the I ² C-bus control signals MODE3 to MODE0.
V _{SSDE1}	16	P	ground 1 or digital supply voltage input E (external pad supply)
LLC	17	O	line-locked system clock output (27 MHz)
V _{DDDE1}	18	P	digital supply voltage E1 (external pad supply 1; 3.3 V)
VPO3 to VPO0	19 to 22	O	digital VPO-bus output signal; lower bits of the 8-bit output bus. The output data types of the VPO-bus are controlled via I ² C-bus registers LCR2 to LCR24 (see Table 7). If I ² C-bus bit VIPB = 1, the lower bits of the digitized input signal are connected to these outputs, configured by the I ² C-bus control signals MODE3 to MODE0.
SDA	23	I/O	serial data input/output (I ² C-bus)
SCL	24	I(O)	serial clock input (I ² C-bus) with inactive output path
RTCO	25	(I/O)	real-time control output; contains information about actual system clock frequency, field rate, odd/even sequence, decoder status, subcarrier frequency and phase and PAL sequence (see external document "RTC Functional Description", available on request); the RTCO pin is enabled via I ² C-bus bit OERT. Remark: this pin is also used as an input pin for test purposes and has an internal pull-down resistor; do not connect any pull-up resistor to this pin
RTS0	26	(I/O)	real-time signal output 0: multifunctional output, controlled by I ² C-bus bits RTSE03 to RTSE00 (see Table 50). RTS0 is strapped during power-on or CE driven reset, defines which I ² C-bus slave address is used; LOW = 48h for write, 49h for read, external pull-down resistor of 3.3 kΩ is needed and HIGH = 4Ah for write, 4Bh for read, default slave address (default, internal pull-up).
RTS1	27	I/O	real-time signal I/O terminal 1: multifunctional output, controlled by I ² C-bus bit RTSE13 to RTSE10 (see Table 51)
V _{SSDI}	28	P	ground for internal digital core supply
V _{DDDI}	29	P	internal core supply (3.3 V)
V _{SSDA}	30	P	digital ground for internal crystal oscillator
XTAL	31	O	second terminal of crystal oscillator; not connected if external clock signal is used
XTALI	32	I	input terminal for crystal oscillator or connection of external oscillator with CMOS compatible square wave clock signal
V _{DDDA}	33	P	digital positive supply voltage for internal crystal oscillator (3.3 V)
V _{DDDE2}	34	P	digital supply voltage E2 (external pad supply 2; 3.3 V)
V _{SSDE2}	35	P	ground 2 for digital supply voltage input E (external pad supply)
TDO	36	O	test data output for boundary scan test; see Table note 3
TCK	37	I	test clock input for boundary scan test; see Table note 3
TDI	38	I	test data input for boundary scan test; see Table note 3
TMS	39	I	test mode select input for boundary scan test or scan test; see Table note 3

Table 3: Pin description...continued

Symbol	Pin	Type	Description
CE	40	I	chip enable, Sleep mode with low power consumption if connected to ground (internal pull-up); internal reset sequence is generated when released
V _{SSA2}	41	P	ground for analog supply voltage channel 2
V _{DDA2}	42	P	positive supply voltage for analog channel 2 (3.3 V)
AI21	43	I	analog input 21
AI2D	44	I	differential analog input for AI21 and AI22; has to be connected to ground via a capacitor; see application diagram of Figure 40

- [1] For board design without boundary scan implementation connect the $\overline{\text{TRST}}$ pin to ground.
- [2] This pin provides easy initialization of the Boundary Scan Test (BST) circuit. $\overline{\text{TRST}}$ can be used to force the Test Access Port (TAP) controller to the TEST_LOGIC_RESET state (normal operation) at once.
- [3] In accordance with the *IEEE1149.1* standard the pads TCK, TDI, TMS and $\overline{\text{TRST}}$ are input pads with an internal pull-up transistor and TDO is a 3-state output pad.

8. Functional description

8.1 Analog input processing

The SAF7113H offers four analog signal inputs, two analog main channels with source switch, clamp circuit, analog amplifier, anti-alias filter and video 9-bit CMOS ADC (see [Figure 6](#)).

8.2 Analog control circuits

The anti-alias filters are adapted to the line-locked clock frequency via a filter control circuit. The characteristics are shown in [Figure 3](#). During the vertical blanking period, gain and clamping control are frozen.

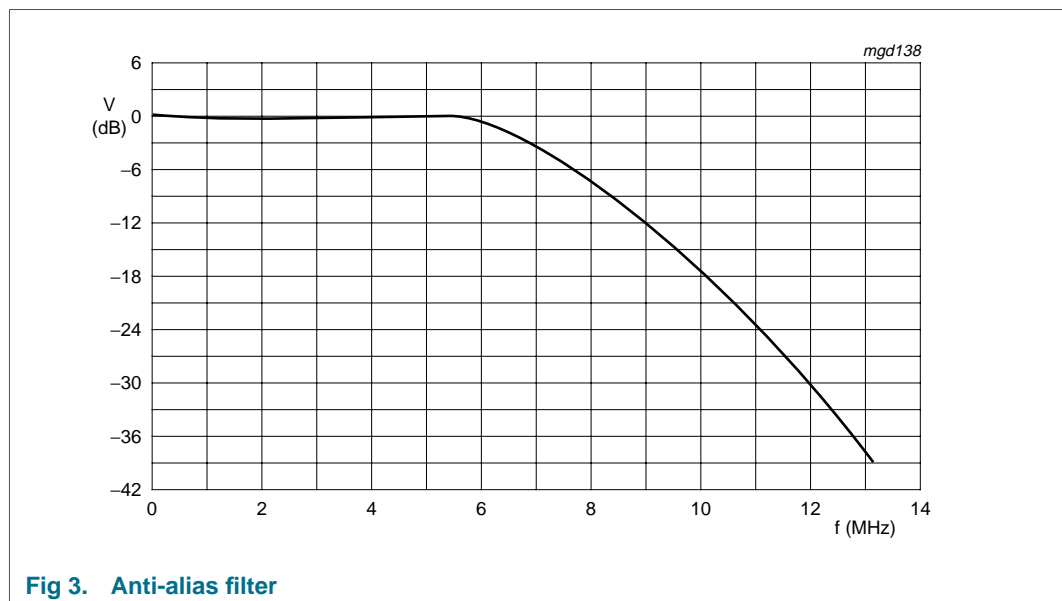

Fig 3. Anti-alias filter

8.2.1 Clamping

The clamp control circuit controls the correct clamping of the analog input signals. The coupling capacitor is also used to store and filter the clamping voltage. An internal digital clamp comparator generates the information with respect to clamp-up or clamp-down. The clamping levels for the two ADC channels are fixed for luminance (120) and chrominance (256). Clamping time in normal use is set with the HCL pulse on the back porch of the video signal.

8.2.2 Gain control

The gain control circuit receives (via the I²C-bus) the static gain levels for the two analog amplifiers or controls one of these amplifiers automatically via a built-in Automatic Gain Control (AGC) as part of the Analog Input Control (AICO). The AGC for luminance is used to amplify a CVBS or Y signal to the required signal amplitude, matched to the ADCs input voltage range. The AGC active time is the sync bottom of the video signal.

Signal (white) peak control limits the gain at signal overshoots. The flow charts (see [Figure 7](#) and [Figure 8](#)) show more details of the AGC. The influence of supply voltage variation within the specified range is automatically eliminated by clamp and automatic gain control.

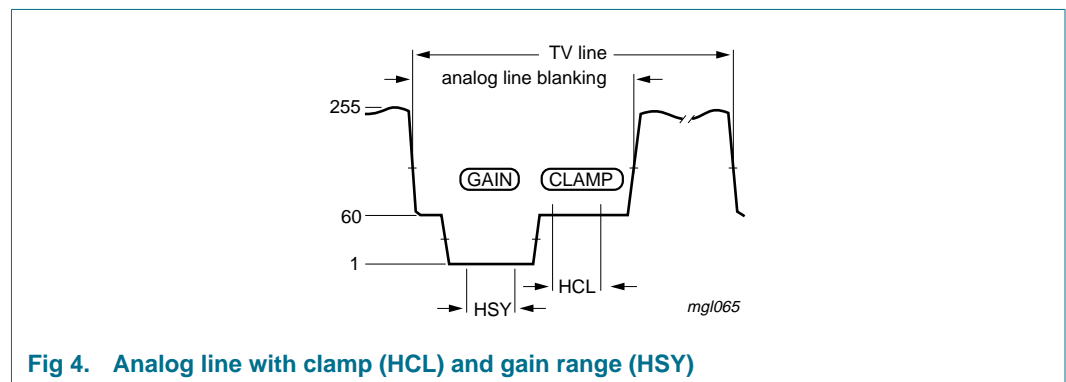

Fig 4. Analog line with clamp (HCL) and gain range (HSY)

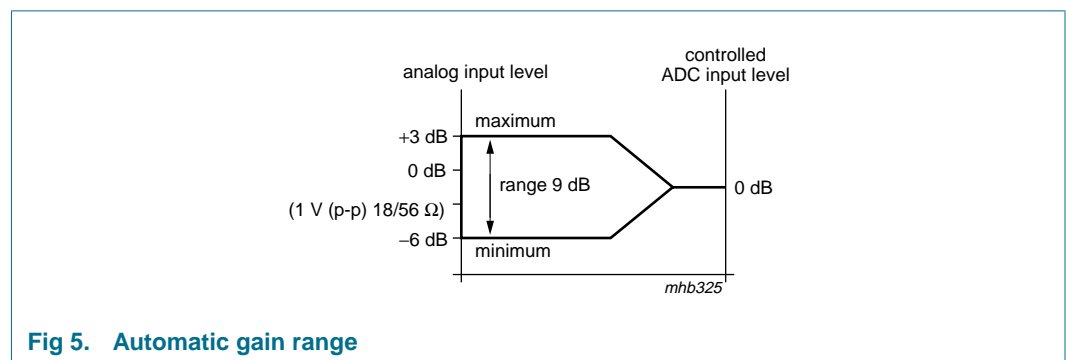

Fig 5. Automatic gain range

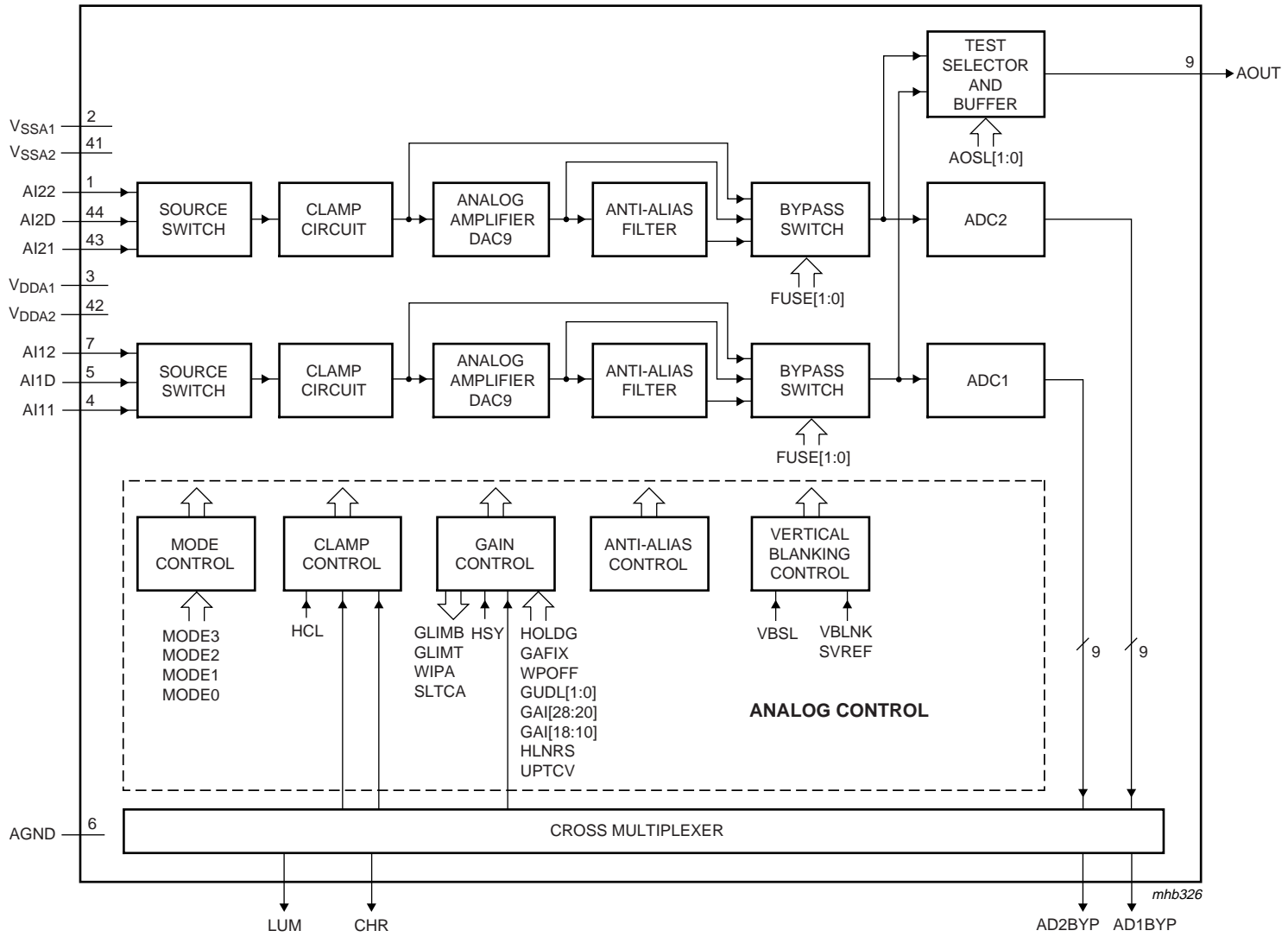
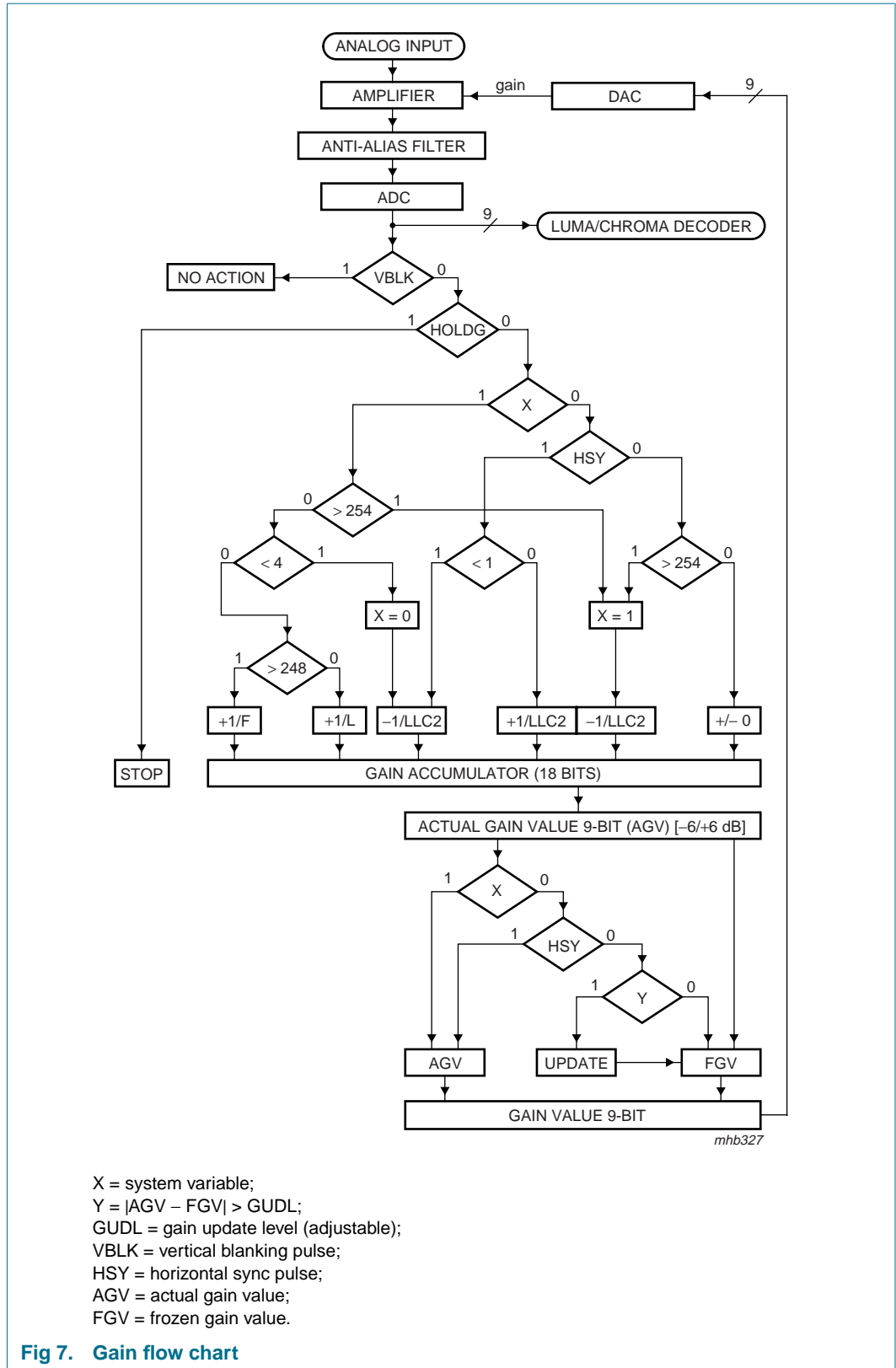
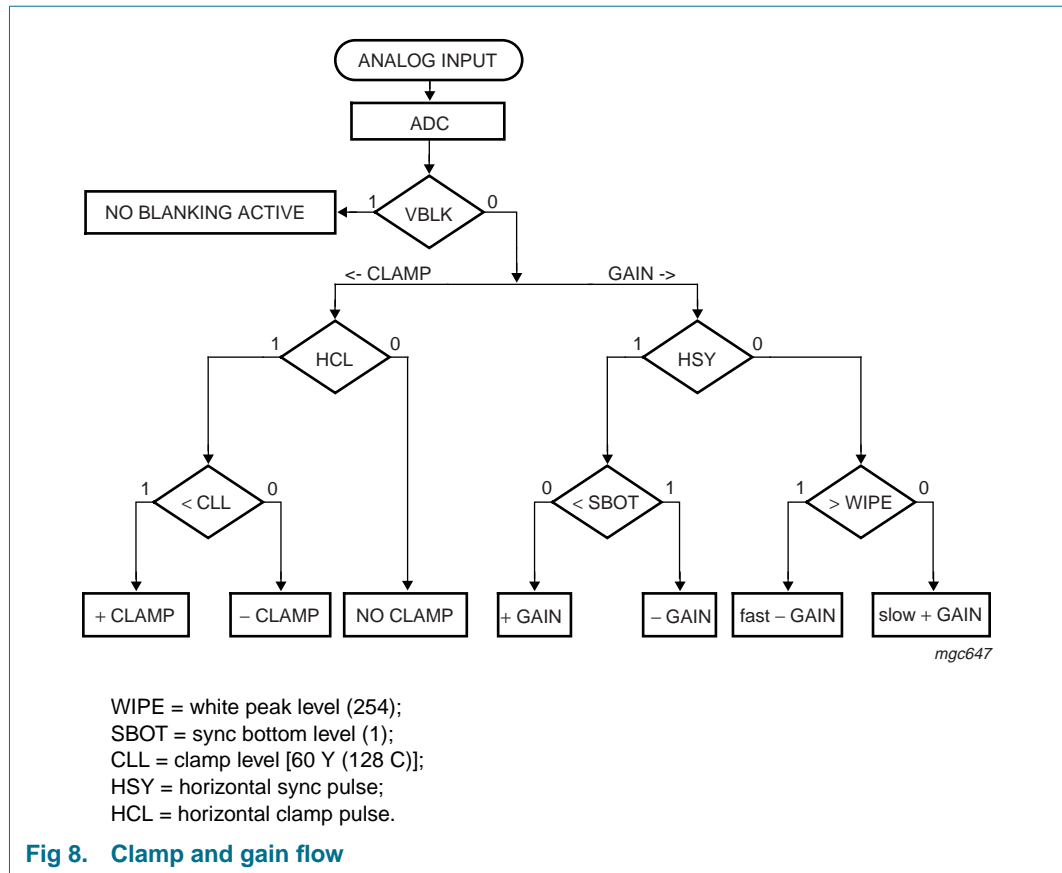

Fig 6. Analog input processing using the SAF7113H as differential front-end with 9-bit ADC





8.3 Chrominance processing

The 9-bit chrominance signal is fed to the multiplication inputs of a quadrature demodulator, where two subcarrier signals from the local oscillator DTO1 are applied (0° and 90° phase relationship to the demodulator axis). The frequency is dependent on the present color standard. The output signals of the multipliers are low-pass filtered (four programmable characteristics) to achieve the desired bandwidth for the color difference signals (PAL and NTSC) or the 0° and 90° FM signals (SECAM).

The color difference signals are fed to the Brightness/Contrast/Saturation block (BCS), which includes the following five functions:

- Automatic Gain Control (AGC) for chrominance PAL and NTSC
- Chrominance amplitude matching (different gain factors for (R – Y) and (B – Y) to achieve ITU-R BT 601 levels C_R and C_B for all standards)
- Chrominance saturation control
- Luminance contrast and brightness
- Limiting YUV to the values 1 (minimum) and 254 (maximum) to fulfil ITU-R BT 601 requirements.

The SECAM processing contains the following blocks:

- Baseband 'bell' filters to reconstruct the amplitude and phase equalized 0° and 90° FM signals
- Phase demodulator and differentiator (FM-demodulation)
- De-emphasis filter to compensate the pre-emphasized input signal, including frequency offset compensation (DB or DR white carrier values are subtracted from the signal, controlled by the SECAM switch signal).

The burst processing block provides the feedback loop of the chrominance PLL and contains:

- Burst gate accumulator
- Color identification and color killer
- Comparison nominal/actual burst amplitude (PAL/NTSC standards only)
- Loop filter chrominance gain control (PAL/NTSC standards only)
- Loop filter chrominance PLL (only active for PAL/NTSC standards)
- PAL/SECAM sequence detection, H/2-switch generation
- Increment generation for DTO1 with divider to generate stable subcarrier for non-standard signals.

The chrominance comb filter block eliminates crosstalk between the chrominance channels in accordance with the PAL standard requirements. For NTSC color standards the chrominance comb filter can be used to eliminate crosstalk from luminance to chrominance (cross-color) for vertical structures. The comb filter can be switched off if desired. The embedded line delay is also used for SECAM recombination (cross-over switches).

The resulting signals are fed to the variable Y-delay compensation and the output interface, which contains the VPO output formatter and the output control logic (see [Figure 10](#)).

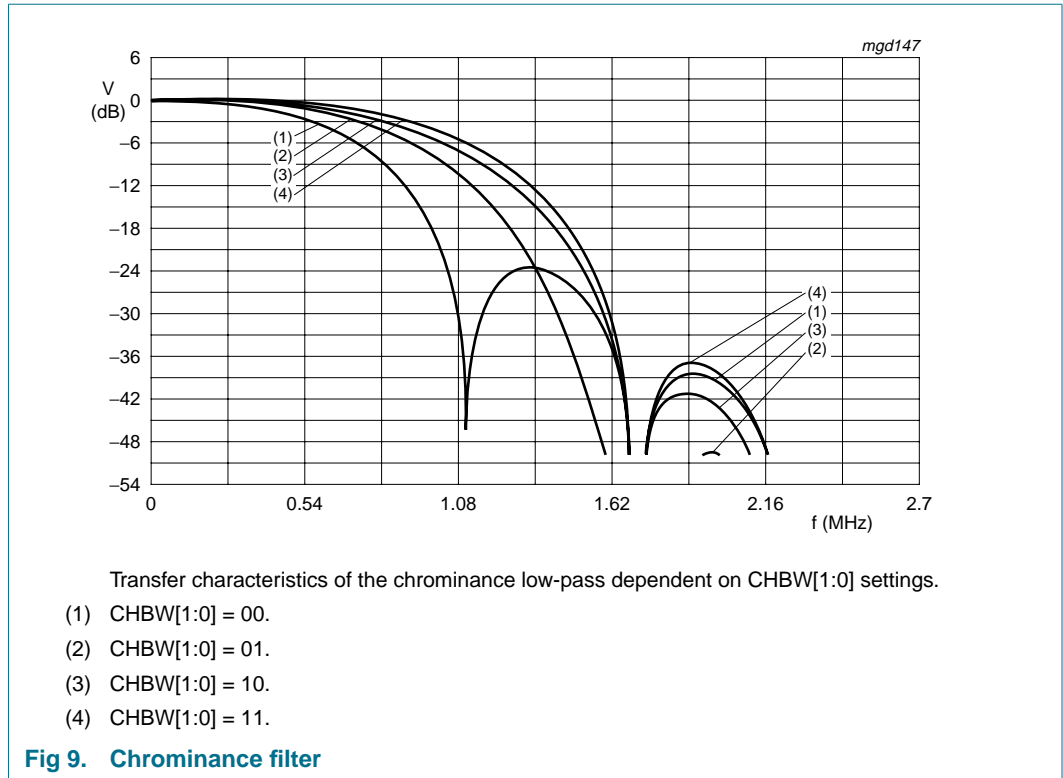

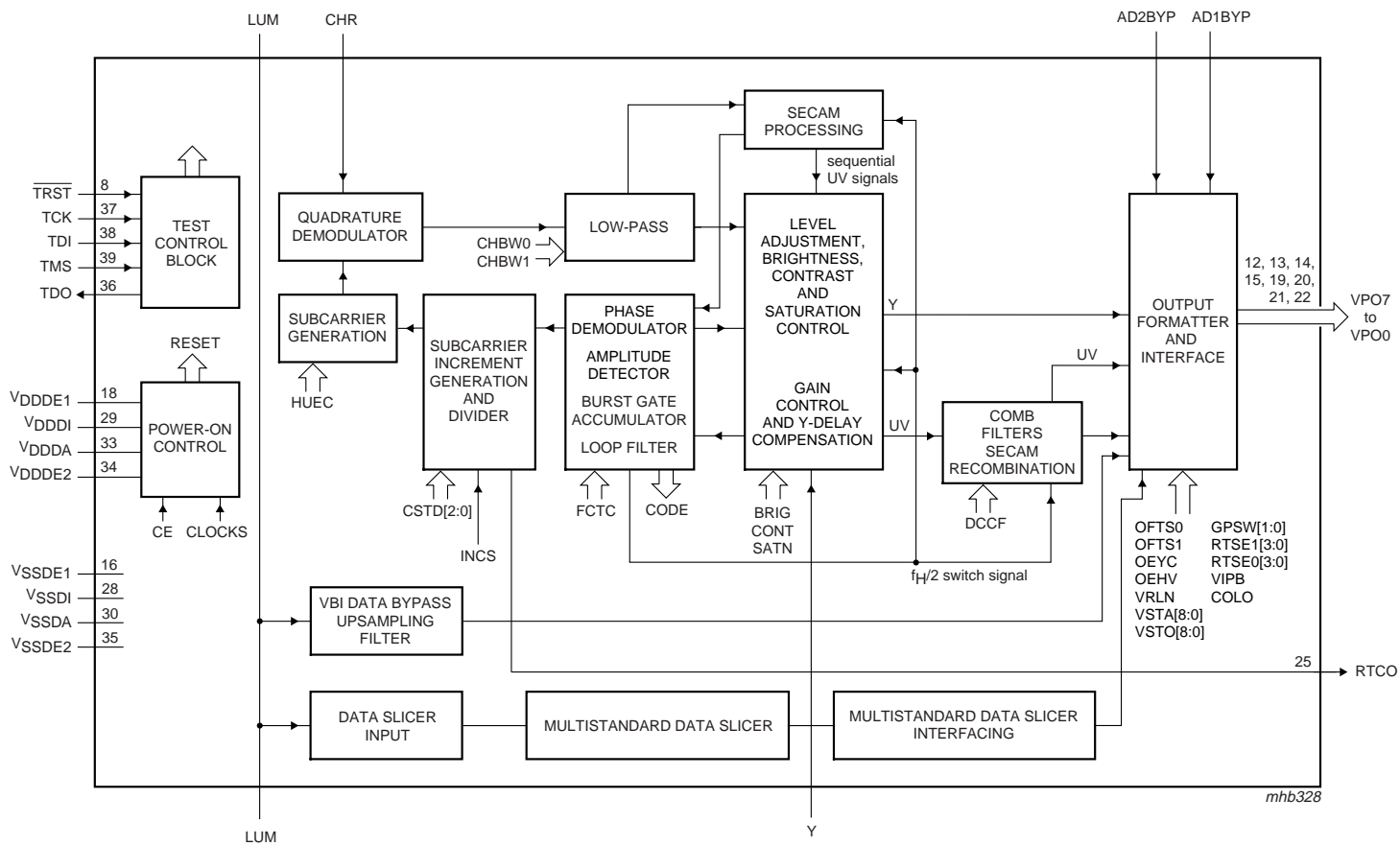
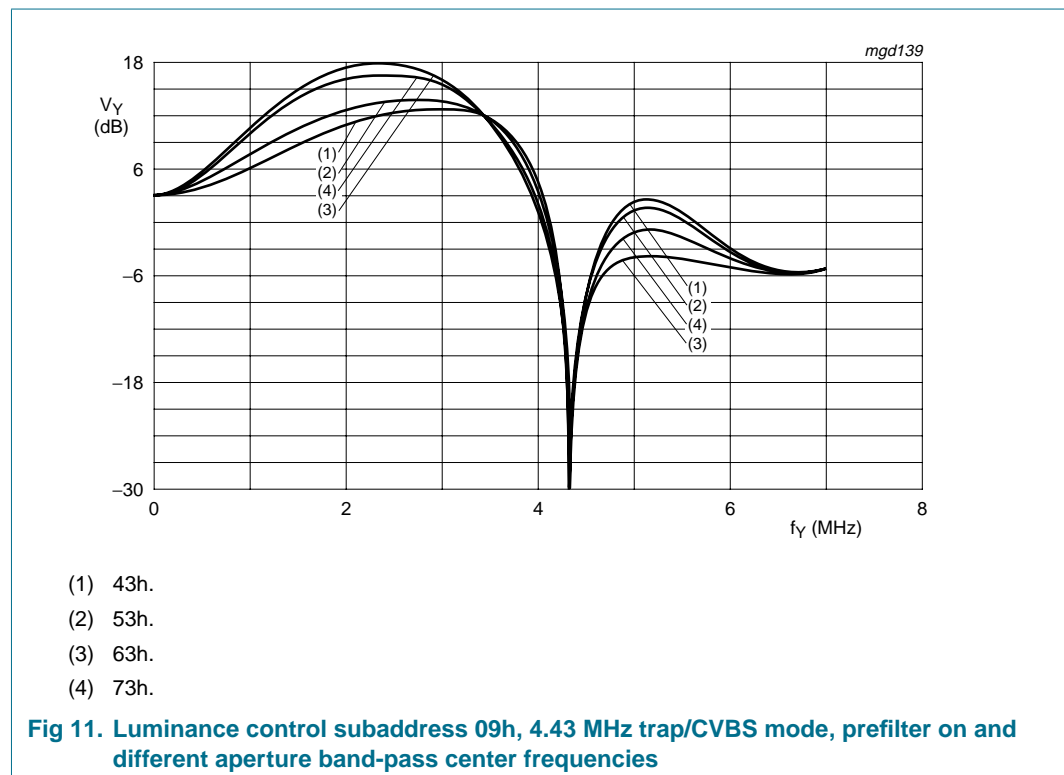

Fig 10. Chrominance circuit, text slicer, VBI-bypass, output formatting, power and test control

8.4 Luminance processing

The 9-bit luminance signal, a digital CVBS format or a luminance format (S-VHS and HI8), is fed through a switchable prefilter. High frequency components are emphasized to compensate for loss. The following chrominance trap filter ($f_0 = 4.43$ MHz or 3.58 MHz center frequency set according to the selected color standard) eliminates most of the color carrier signal. It should be bypassed via I²C-bus bit BYPS (subaddress 09h, bit 7) for S-video (S-VHS and HI8) signals.

The high frequency components of the luminance signal can be peaked (control for sharpness improvement via I²C-bus subaddress 09h; see [Table 37](#)) in two band-pass filters with selectable transfer characteristic. This signal is then added to the original (unpeaked) signal. For the resulting frequency characteristics see [Figure 11](#) to [Figure 18](#). A switchable amplifier achieves common DC amplification, because the DC gains are different in both chrominance trap modes. The improved luminance signal is fed to the BCS control located in the chrominance processing block (see [Figure 19](#)).



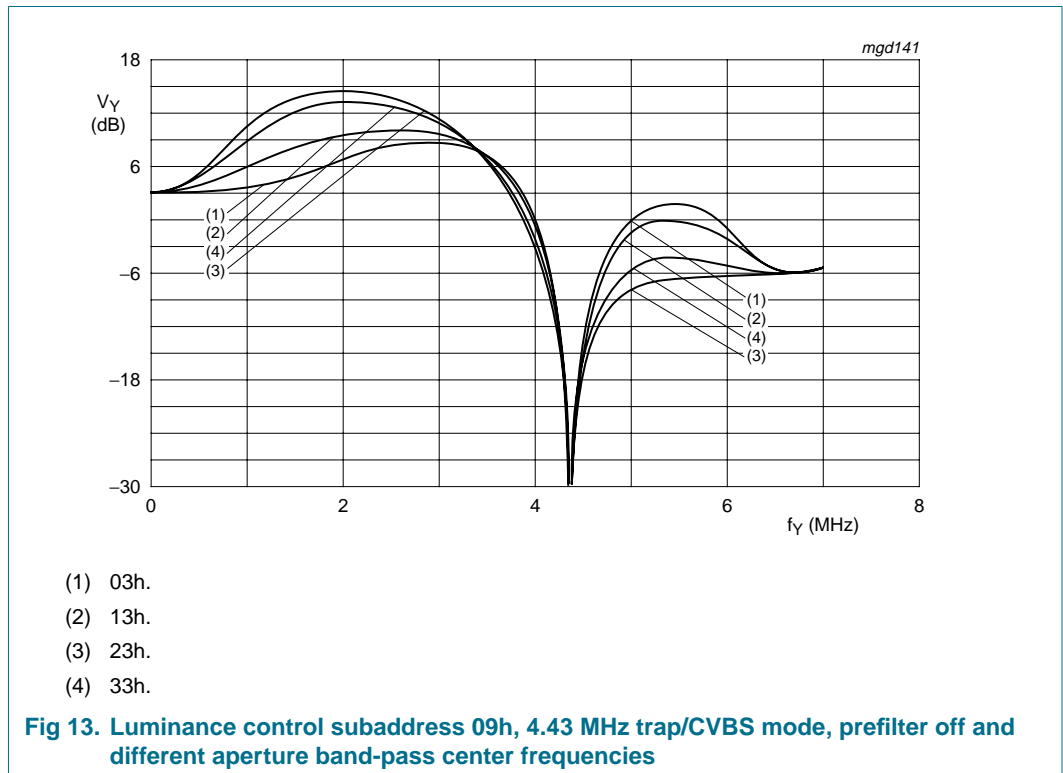
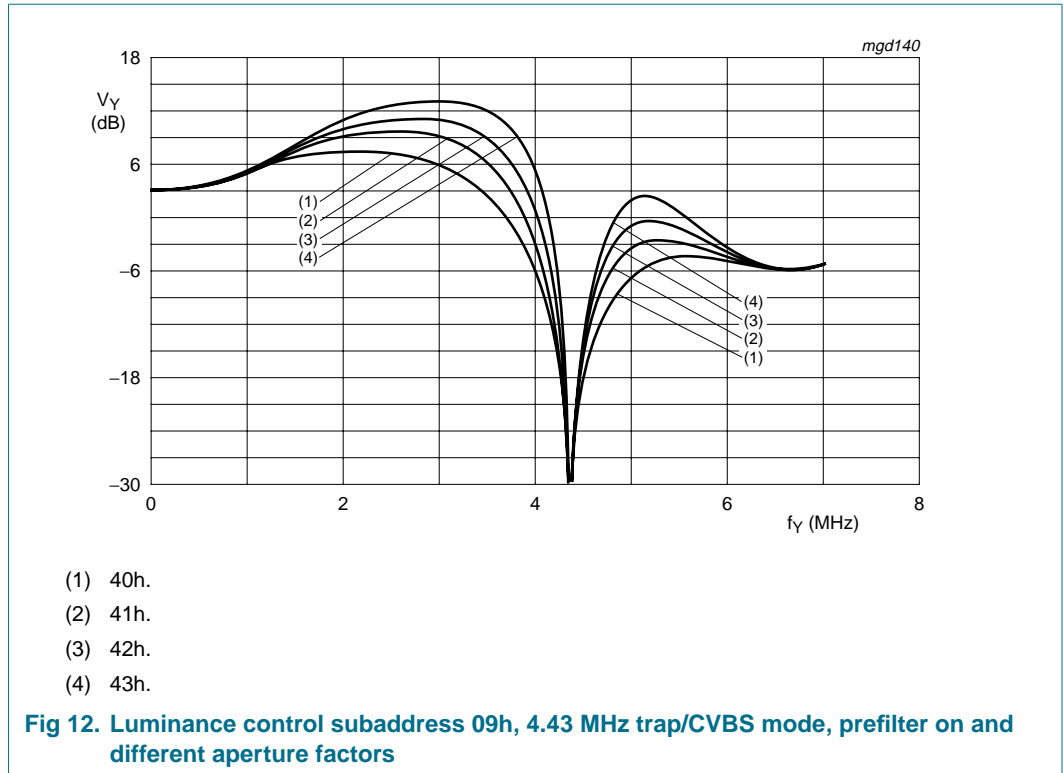

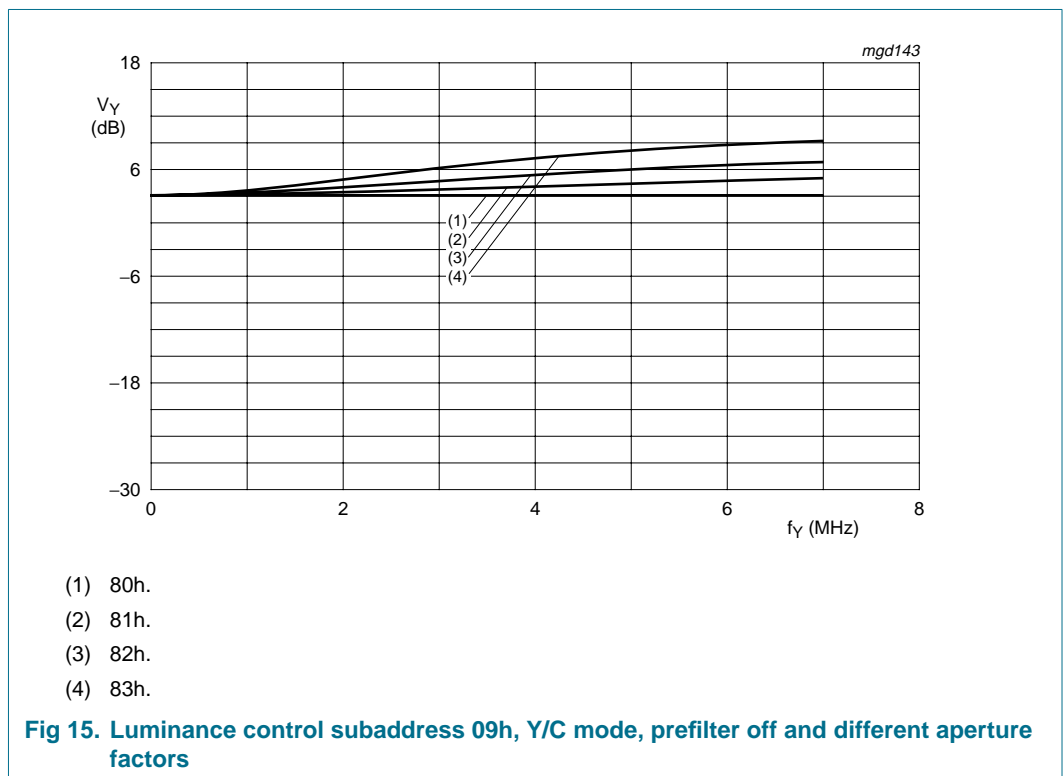
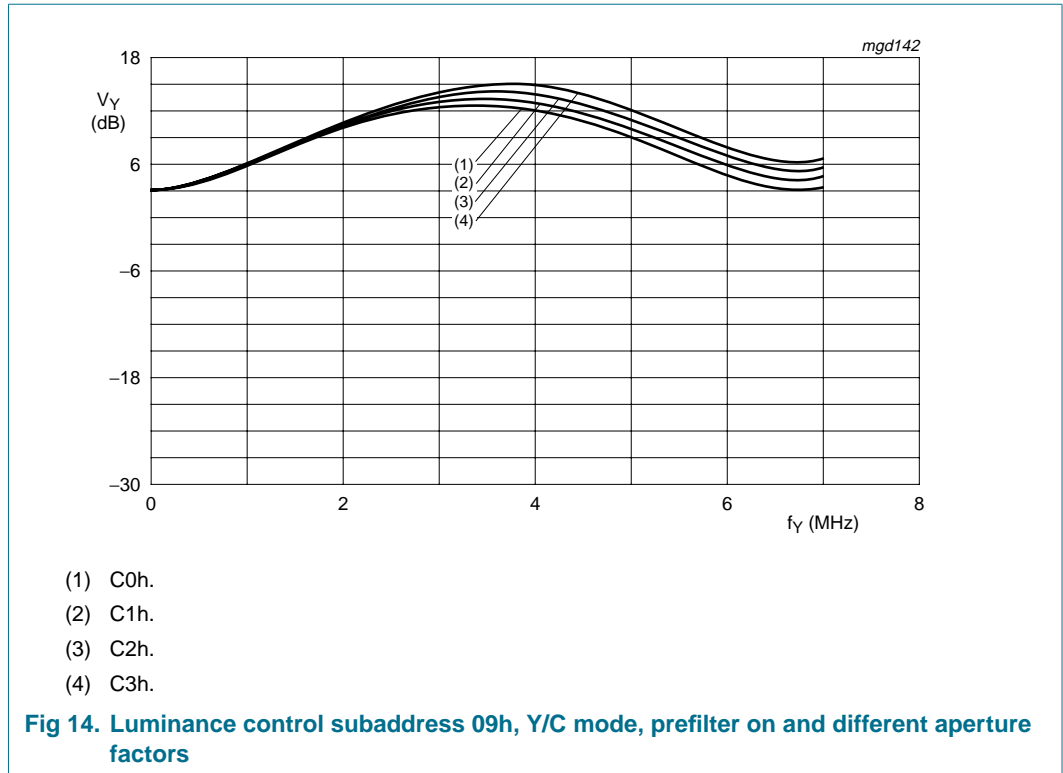

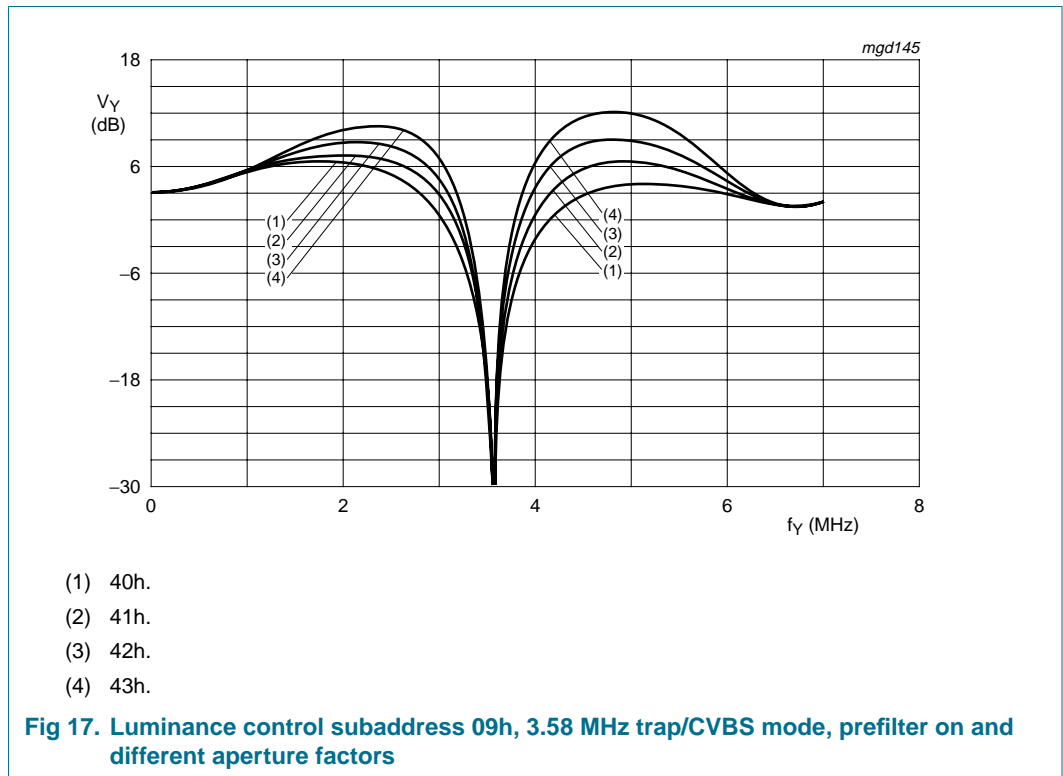
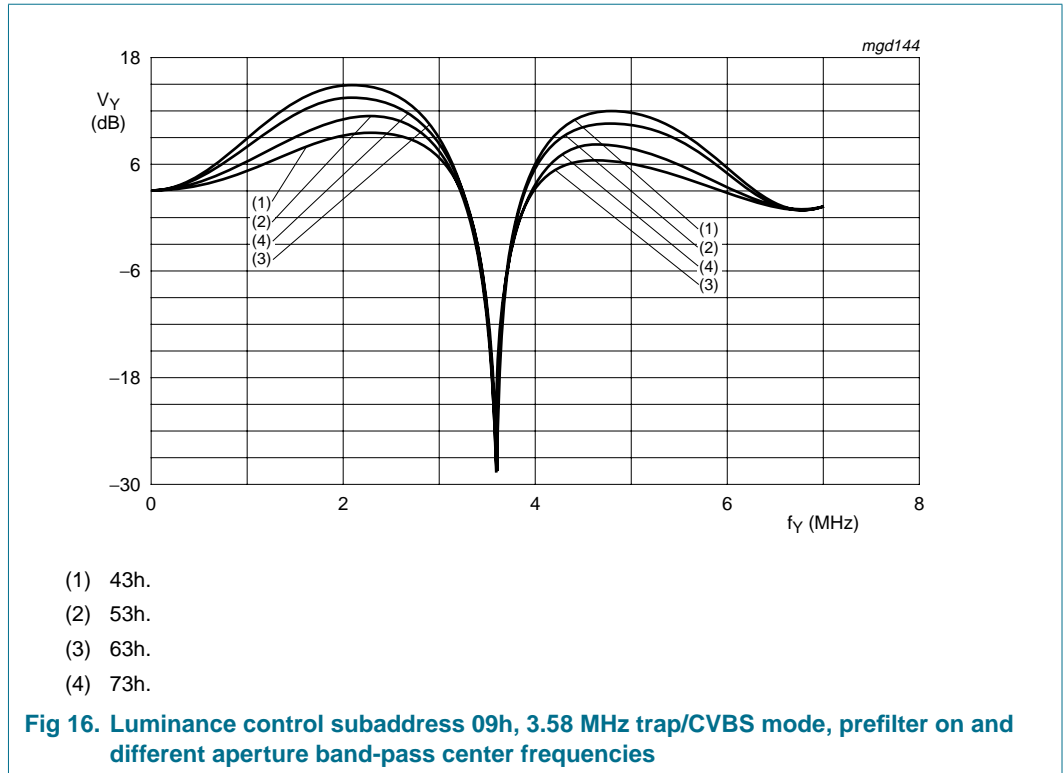

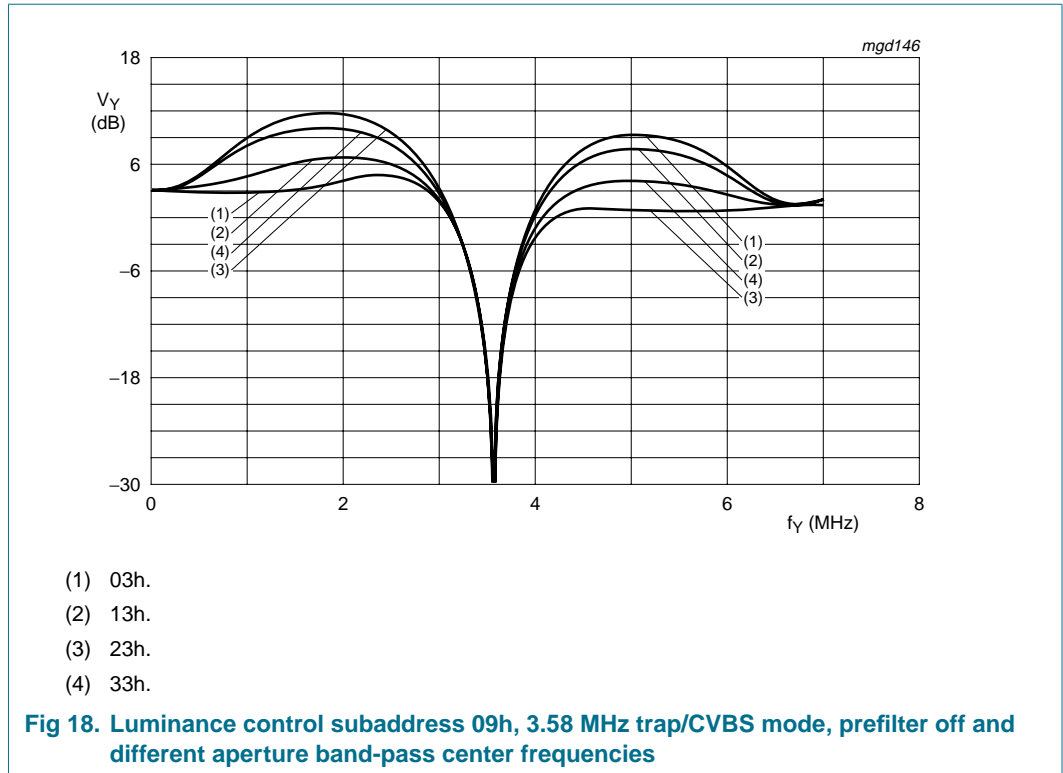

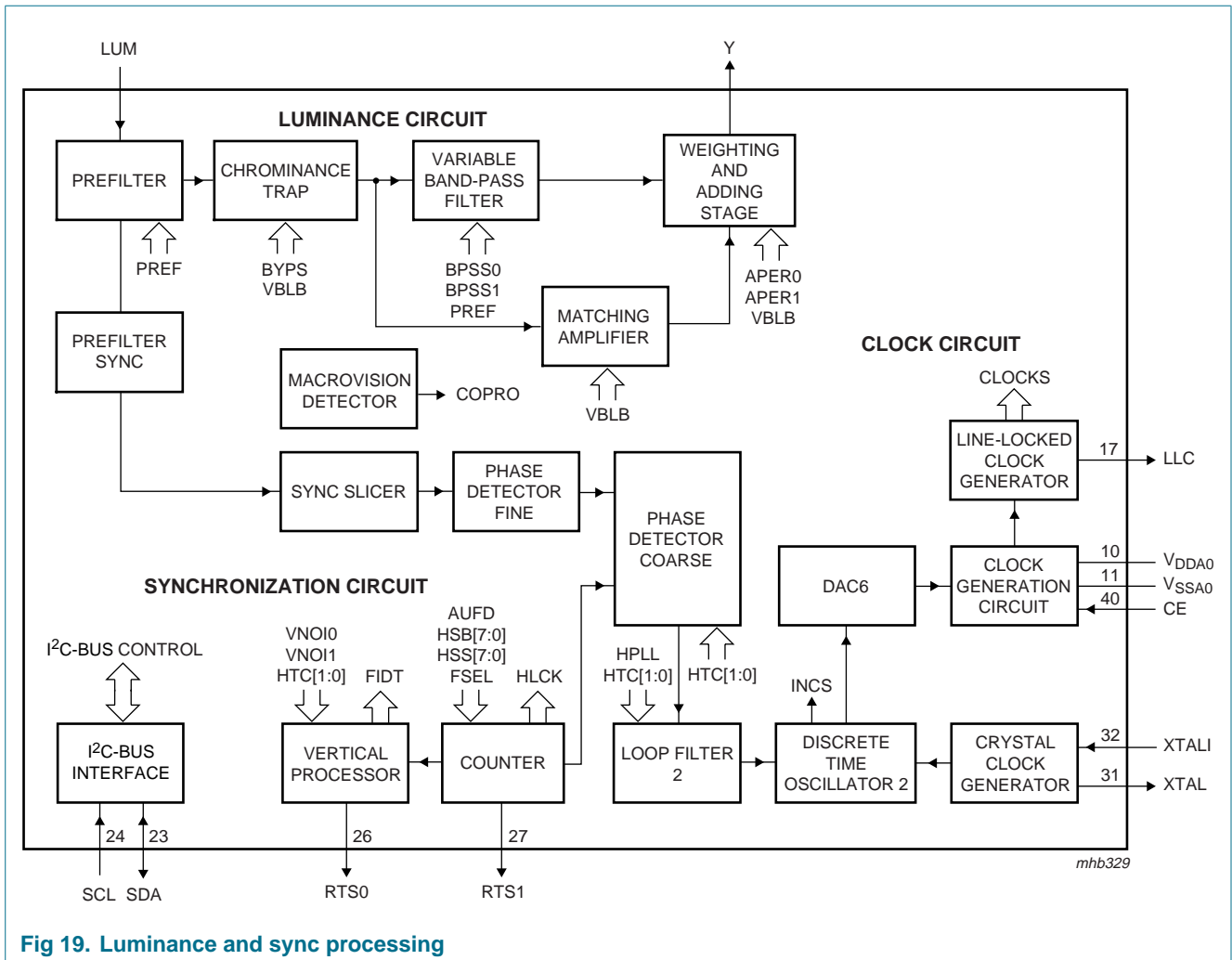

Fig 19. Luminance and sync processing

8.5 Synchronization

The prefiltered luminance signal is fed to the synchronization stage. Its bandwidth is further reduced to 1 MHz in a low-pass filter. The sync pulses are sliced and fed to the phase detectors where they are compared with the sub-divided clock frequency. The resulting output signal is applied to the loop filter to accumulate all phase deviations. Internal signals (e.g. HCL and HSY) are generated in accordance with analog front-end requirements. The loop filter signal drives an oscillator to generate the line frequency control signal LFCO (see [Figure 19](#)).

The detection of 'pseudo syncs' as part of the Macrovision copy protection standard is also done within the synchronization circuit.

The result is reported as flag COPRO within the decoder status byte at subaddress 1Fh.

8.6 Clock generation circuit

The internal CGC generates all clock signals required for the video input processor. The internal signal LFCO is a digital-to-analog converted signal provided by the horizontal PLL. It is the multiple of the line frequency: $6.75 \text{ MHz} = 429 \times f_H$ (50 Hz) or $6.75 \text{ MHz} = 432 \times f_H$ (60 Hz).

Internally the LFCO signal is multiplied by a factor of 2 and 4 in the PLL circuit (including phase detector, loop filtering, VCO and frequency divider) to obtain the output clock signals. The rectangular output clocks have a 50 % duty factor.

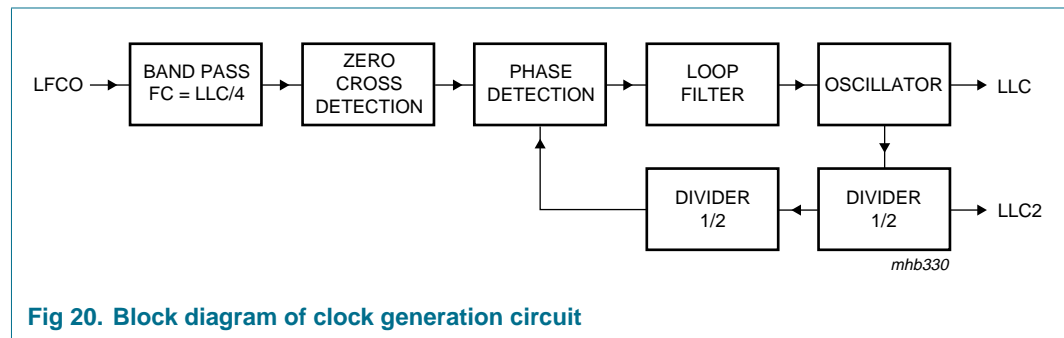

Fig 20. Block diagram of clock generation circuit

Table 4: Clock frequencies

Clock	Frequency (MHz)
XTAL	24.576
LLC	27
LLC2 (internal)	13.5
LLC4 (internal)	6.75
LLC8 (virtual)	3.375

8.7 Power-on reset and CE input

A missing clock, insufficient digital or analog V_{DDA0} supply voltages (below 2.8 V) will initiate the reset sequence; all outputs are forced to 3-state (see [Figure 21](#)).

It is possible to force a reset by pulling the Chip Enable (CE) input to ground. After the rising edge of CE and sufficient power supply voltage, the outputs LLC and SDA return from 3-state to active, while RTS0, RTS1 and RTCO remain in 3-state and have to be activated via I²C-bus programming (see [Table 5](#)).

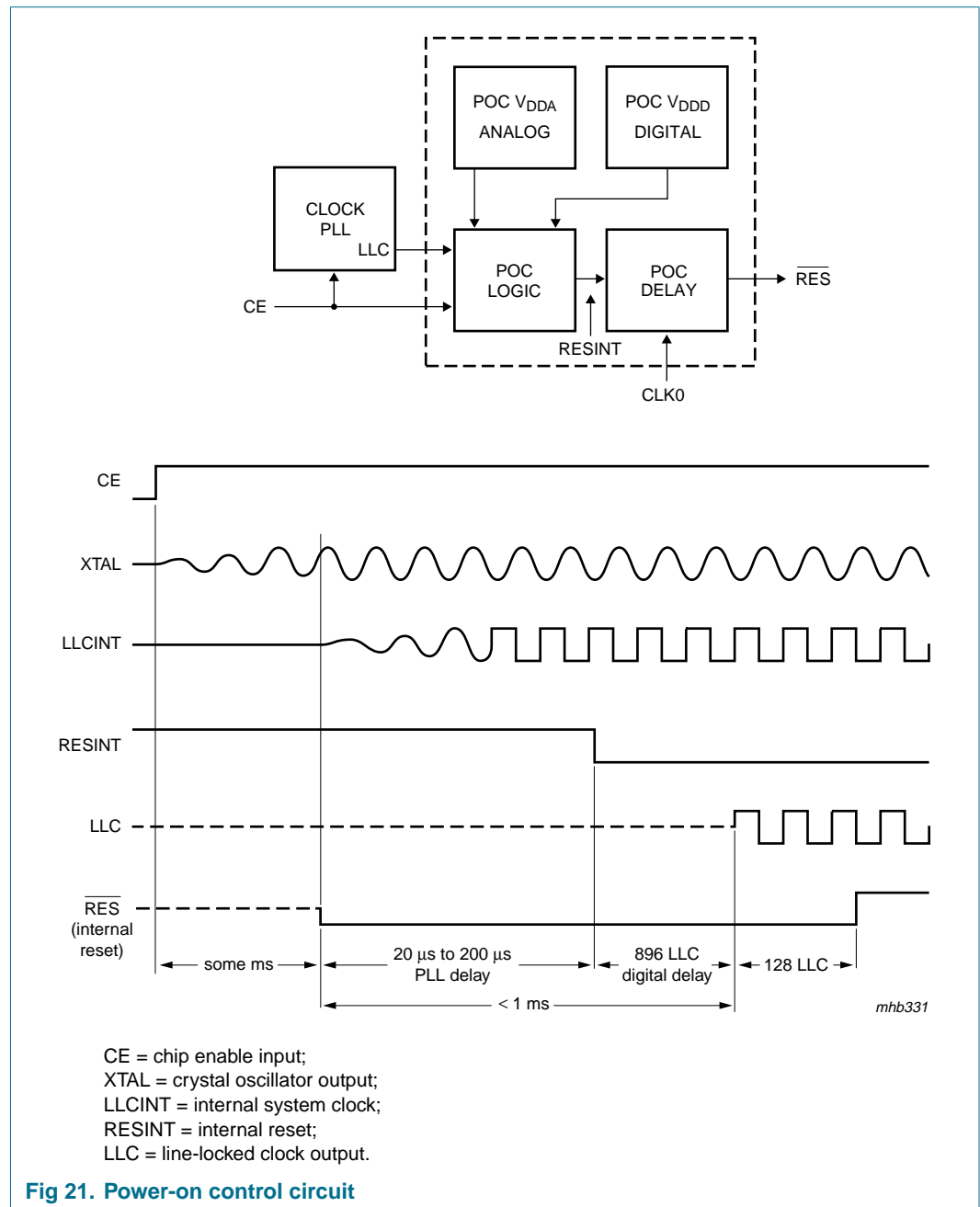

Table 5: Power-on control sequence

Internal power-on control sequence	Pin output status	Remarks
Directly after power-on asynchronous reset	VPO7 to VPO0, RTCO, RTS0, RTS1, SDA and LLC are in high-impedance state	direct switching to high-impedance for 20 ms to 200 ms
Synchronous reset sequence	LLC and SDA become active; VPO7 to VPO0, RTCO, RTS0 and RTS1 are held in high-impedance state	internal reset sequence
Status after power-on control sequence	VPO7 to VPO0, RTCO, RTS0 and RTS1 are held in high-impedance state	after power-on (reset sequence) a complete I ² C-bus transmission is required

8.8 Multistandard VBI data slicer

The multistandard data slicer is a Vertical Blanking Interval (VBI) and Full Field (FF) video data acquisition block. In combination with software modules the slicer acquires most existing formats of broadcast VBI and FF data.

The implementation and programming model of the multistandard VBI data slicer is similar to the text slicer built in the SAA5284 (Multimedia video data acquisition circuit).

The circuitry recovers the actual clock phase during the clock run-in period, slices the data bits with the selected data rate, and groups them into bytes. The clock frequency, signal source, field frequency and accepted error count must be defined via the I²C-bus in subaddress 40h, bits 7 to 4.

Several standards can be selected per VBI line. The supported VBI data standards are described in [Table 6](#).

The programming of the desired standards is done via I²C-bus subaddresses 41h to 57h (LCR2[7:0] to LCR24[7:0]); see detailed description in [Section 8.10](#). To adjust the slicers processing to the signals source, there are offsets in horizontal and vertical direction available via the I²C-bus in subaddresses 5Bh (HOFF[10:8]), 59h (HOFF[7:0]) and 5Bh (VOFF[8]) and 5Ah (VOFF[7:0]). The formatting of the decoded VBI data is done within the output interface to the VPO-bus. For a detailed description of the sliced data format see [Table 20](#).

Table 6: Supported VBI standards

Standard type	Data rate (Mbit/s)	Framing code	FC window	Hamming check
Teletext EuroWST, CCST	6.9375	27h	WST625	always
European closed caption	0.500	001	CC625	
VPS	5	9951h	VPS	
Wide screen signalling bits	5	1E3C1Fh	WSS	
US teletext (WST)	5.7272	27h	WST525	always
US closed caption (line 21)	0.503	001	CC525	
Teletext	6.9375	programmable	general text	optional
VITC/EBU time codes (Europe)	1.8125	programmable	VITC625	
VITC/SMPTE time codes (USA)	1.7898	programmable	VITC625	

Table 6: Supported VBI standards...continued

Standard type	Data rate (Mbit/s)	Framing code	FC window	Hamming check
US NABTS	5.7272	programmable	NABTS	optional
MOJI (Japanese)	5.7272	programmable (A7h)	Japtext	
Japanese format switch (L20/22)	5	programmable		

8.9 VBI-raw data bypass

For a 27 MHz VBI-raw data bypass the digitized CVBS signal is upsampled after analog-to-digital conversion. Suppressing of the back folded CVBS frequency components after upsampling is achieved by an interpolation filter (see [Figure 22](#)).

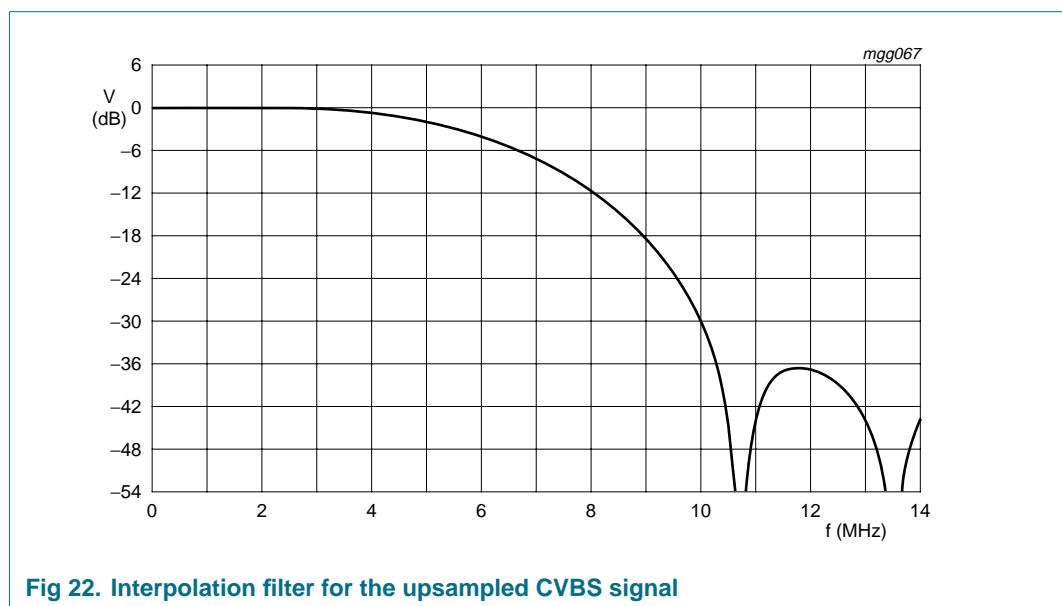

Fig 22. Interpolation filter for the upsampled CVBS signal

8.10 Digital output port VPO7 to VPO0

The 8-bit VPO-bus can carry 16 data types in three different formats, selectable by the control registers LCR2 to LCR24 (see also [Section 9](#), subaddresses 41h to 57h).

Table 7: VPO-bus data formats and types

Data type number	Data format	Data type	Name	Number of valid bytes sent per line [1]
0	sliced	teletext EuroWST, CCST	WST625	88
1	sliced	European closed caption	CC625	8
2	sliced	VPS	VPS	56
3	sliced	wide screen signalling bits	WSS	32
4	sliced	US teletext (WST)	WST525	72
5	sliced	US closed caption (line 21)	CC525	8
6	YUV 4 : 2 : 2	video component signal, VBI region	test line	1440
7	raw	oversampled CVBS data	Intercast	programmable

Table 7: VPO-bus data formats and types...continued

Data type number	Data format	Data type	Name	Number of valid bytes sent per line ^[1]
8	sliced	teletext	general text	88
9	sliced	VITC/EBU time codes (Europe)	VITC625	26
10	sliced	VITC/SMPTE time codes (USA)	VITC625	26
11	reserved	reserved	-	-
12	sliced	US NABTS	NABTS	72
13	sliced	MOJI (Japanese)	Japtext	74
14	sliced	Japanese format switch (L20/22)	JFS	56
15	YUV 4 : 2 : 2	video component signal, active video region	active video	1440

[1] The number of valid bytes per line can be less for the sliced data format if standard not recognized (wrong standard or poor input signal).

For each LCR value from 2 to 23 the data type can be programmed individually. LCR2 to LCR23 refer to line numbers. The selection in LCR24 values is valid for the rest of the corresponding field. The upper nibble contains the value for field 1 (odd), the lower nibble for field 2 (even). The relationship between LCR values and line numbers can be adjusted via VOFF[8:0] (located in subaddresses 5Bh, bit 4 and 5Ah, bits 7 to 0). The recommended values are 07h for 50 Hz sources and 0Ah for 60 Hz sources, to accommodate line number conventions as used for PAL, SECAM and NTSC standards (see [Table 11](#), [Table 12](#), [Table 13](#) and [Table 14](#)).

Some details about data types:

- **Active video** (data type 15) component YUV 4 : 2 : 2 signal, 720 active pixels per line. Format and nominal levels are given in [Figure 23](#) and [Table 16](#).
- **Test line** (data type 6), is similar to decoded YUV data as in active video, with two exceptions:
 - vertical filter (chrominance comb filter for NTSC standards, PAL-phase-error correction) within the chrominance processing is disabled
 - peaking and chrominance trap are bypassed within the luminance processing, if I²C-bus bit VBLB is set. This data type is defined for future enhancements; it could be activated for lines containing standard test signals within the vertical blanking period; currently the most sources do not contain test lines.

This data type is available only in lines with VREF = 0 (I²C-bus detail section, see [Table 46](#)). Format and nominal levels are given in [Figure 23](#) and [Table 16](#).

- **Raw samples** (data type 7) oversampled CVBS-signal for Intercast applications; the data rate is 27 MHz. The horizontal range is programmable via HSB7 to HSB0, HSS7 to HSS0 and HDEL1 and HDEL0 (see I²C-bus section subaddresses 06h, 07h and 10h and [Table 34](#), [Table 35](#) and [Table 47](#)). Format and nominal levels are given in [Figure 24](#) and [Table 18](#).
- **Sliced data** (various standards, data types 0 to 5 and 8 to 14). The format is given in [Table 20](#).

The data type selections by LCR are overruled by setting VIPB (subaddress 11h, bit 1) to logic 1. This setting is mainly intended for device production tests. The VPO-bus carries the upper or lower 8 bits of the two ADCs depending on the ADLSB (subaddress 13h, bit 7) setting. The output configuration is done via MODE3 to MODE0 settings (subaddress 02h, bits 3 to 0; see [Table 28](#)). If the YC-mode is selected, the VPO-bus carries the multiplexed output signals of both ADCs, in CVBS-mode the output of only one ADC. No timing reference codes are generated in this mode.

Remark: The LSBs (bit 0) of the ADCs are available on pins RTS0 or RTS1. See [Section 9](#), subaddress 12h for details.

The SAV/EAV timing reference codes define start and end of valid data regions.

Table 8: SAV/EAV format

Bit	Symbol	Description
7		logic 1
6	F	field bit 1st field: F = 0 2nd field: F = 1 for vertical timing see Table 9 and Table 10
5	V	vertical blanking bit VBI: V = 1 active video: V = 0 for vertical timing see Table 9 and Table 10
4	H	H = 0 in SAV; H = 1 in EAV
3 to 0	P[3:0]	reserved; evaluation not recommended (protection bits according to ITU-R BT 656)

The generation of the H-bit and consequently the timing of SAV/EAV corresponds to the selected data format. H = 0 during active data region. For all data formats excluding data type 7 (raw data), the length of the active data region is 1440 LLC. For the YUV 4 : 2 : 2 formats (data types 15 and 6) every clock cycle within this range contains valid data (see [Table 16](#)).

The sliced data stream (various standards, data types 0 to 5 and 8 to 14; see [Table 20](#)) contains also invalid cycles marked as 00h.

The length of the raw data region (data type 7) is programmable via HSB7 to HSB0 and HSS7 to HSS0 (subaddresses 06h and 07h; see [Figure 24](#)).

During horizontal blanking period between EAV and SAV the ITU-blanking code sequence '-80-10-80-10-...' is transmitted.

The position of the F-bit is constant according to ITU-R BT 656 (see [Table 9](#) and [Table 10](#)).

The V-bit can be generated in four different ways (see [Table 9](#) and [Table 10](#)) controlled via OFTS1 and OFTS0 (subaddress 10h, bits 7 and 6), VRLN (subaddress 10h, bit 3) and LCR2 to LCR24 (subaddresses 41h to 57h).

F and V bits change synchronously with the EAV code.

Table 9: 525 lines/60 Hz vertical timing

Line number	F (ITU-R BT 656)	V			OFTS1 = 1; OFTS0 = 0
		OFTS1 = 0; OFTS0 = 0 (ITU-R BT 656)	OFTS1 = 0; OFTS0 = 1 VRLN = 0	VRLN = 1	
1 to 3	1	1	1	1	according to selected data type via LCR2 to LCR24 (subaddresses 41h to 57h): data types 0 to 14: V = 1; data type 15: V = 0
4 to 19	0	1	1	1	
20	0	0	1	1	
21	0	0	1	0	
22 to 261	0	0	0	0	
262	0	0	1	0	
263	0	0	1	1	
264 and 265	0	1	1	1	
266 to 282	1	1	1	1	
283	1	0	1	1	
284	1	0	1	0	
285 to 524	1	0	0	0	
525	1	0	1	0	

Table 10: 625 lines/50 Hz vertical timing

Line number	F (ITU-R BT 656)	V			OFTS1 = 1; OFTS0 = 0
		OFTS1 = 0; OFTS0 = 0 (ITU-R BT 656)	OFTS1 = 0; OFTS0 = 1 VRLN = 0	VRLN = 1	
1 to 22	0	1	1	1	according to selected data type via LCR2 to LCR24 (subaddresses 41h to 57h): data types 0 to 14: V = 1; data type 15: V = 0
23	0	0	1	0	
24 to 309	0	0	0	0	
310	0	0	1	0	
311 and 312	0	1	1	1	
313 to 335	1	1	1	1	
336	1	0	1	0	
337 to 622	1	0	0	0	
623	1	0	1	0	
624 and 625	1	1	1	1	

Table 11: Relationship of LCR to line numbers in 525 lines/60 Hz systems (part 1)

Vertical line offset VOFF8 to VOFF0 = 00Ah; horizontal pixel offset HOFF10 to HOFF0 = 354h, FOFF = 1, FASET = 1																
Line number (1st field)	519	520	521	522	523	524	525	1	2	3	4	5	6	7	8	9
	active video							equalization pulses			serration pulses			equalization pulses		
Line number (2nd field)	257	258	259	260	261	262	263	264	265	266	267	268	269	270	271	272
	active video							equalization pulses			serration pulses			equalization pulses		
LCR (VOFF = 00Ah; HOFF = 354h; FOFF = 1; FASET = 1)	24								2	3	4	5	6	7	8	9

Table 12: Relationship of LCR to line numbers in 525 lines/60 Hz systems (part 2)

Vertical line offset VOFF8 to VOFF0 = 00Ah; horizontal pixel offset HOFF10 to HOFF0 = 354h, FOFF = 1, FASET = 1																	
Line number (1st field)	10	11	12	13	14	15	16	17	18	19	20	21	22	23			
	nominal VBI-lines F1												active video				
Line number (2nd field)	273	274	275	276	277	278	279	280	281	282	283	284	285	286			
	nominal VBI-lines F2												active video				
LCR (VOFF = 00Ah; HOFF = 354h; FOFF = 1; FASET = 1)	10	11	12	13	14	15	16	17	18	19	20	21	22	23			

Table 13: Relationship of LCR to line numbers in 625 lines/50 Hz systems (part 1)

Vertical line offset VOFF8 to VOFF0 = 007h; horizontal pixel offset HOFF10 to HOFF0 = 354h, FOFF = 1, FASET = 0																		
Line number (1st field)	621	622	623	624	625	1	2	3	4	5								
	active video				equalization pulses				serration pulses			equalization pulses						
Line number (2nd field)	309	310	311	312	313	314	315	316	317	318								
	active video			equalization pulses				serration pulses			equalization pulses							
LCR (VOFF = 007h; HOFF = 354h; FOFF = 1; FASET = 0)	24								2	3	4	5						

Table 14: Relationship of LCR to line numbers in 625 lines/50 Hz systems (part 2)

Vertical line offset VOFF8 to VOFF0 = 007h; horizontal pixel offset HOFF10 to HOFF0 = 354h, FOFF = 1, FASET = 0																				
Line number (1st field)	6	7	8	9	10	11	12	13	14	15	16	17	18	19	20	21	22	23	24	25
	nominal VBI-lines F1																			active video
Line number (2nd field)	319	320	321	322	323	324	325	326	327	328	329	330	331	332	333	334	335	336	337	338
	nominal VBI-lines F2																			active video
LCR (VOFF = 007h; HOFF = 354h; FOFF = 1; FASET = 0)	6	7	8	9	10	11	12	13	14	15	16	17	18	19	20	21	22	23	24	

Table 15: Location of related programming registers

Name	Subaddress
VOFF[8:0]	5Bh[4] and 5Ah[7:0]
HOFF[10:0]	5Bh[2:0] and 59h[7:0]
FOFF	5Bh[7]
FASET	40h[7]

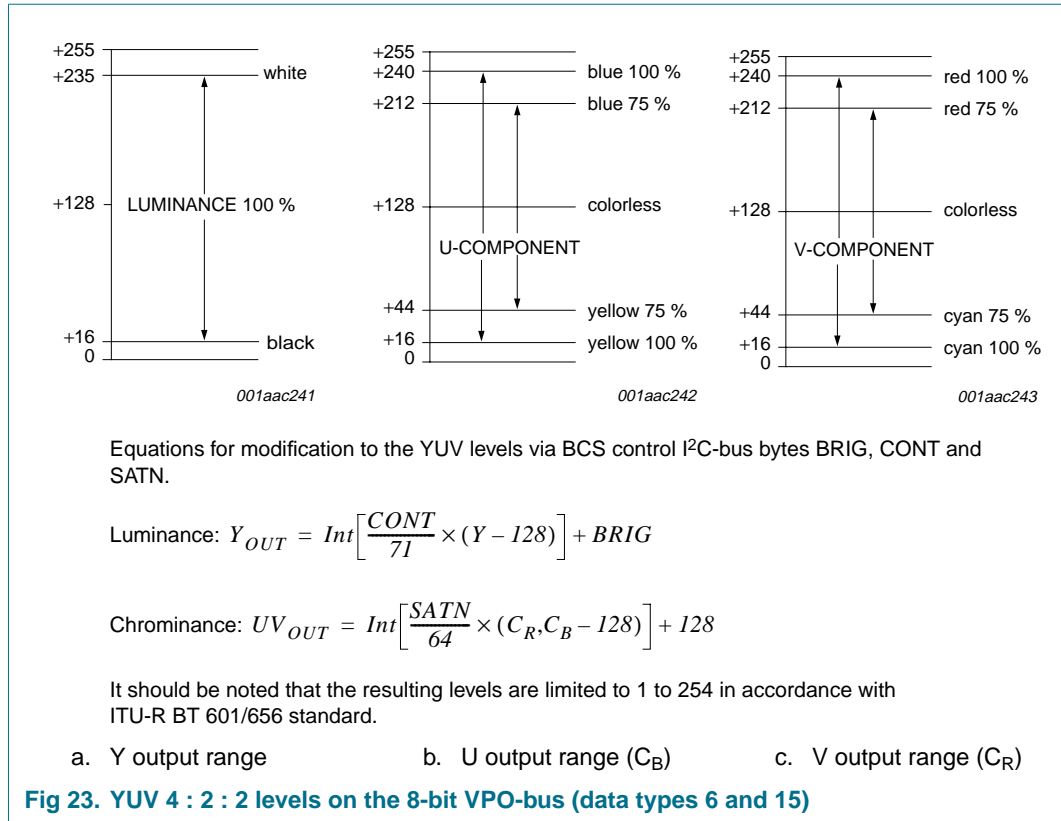

Table 16: YUV data format on the 8-bit VPO-bus (data types 6 and 15)

Blanking period			Timing reference code				720 pixels YUV 4 : 2 : 2 data							Timing reference code				Blanking period				
...	80	10	FF	00	00	SAV	C _B 0	Y0	C _R 0	Y1	C _B 2	Y2	...	C _R 718	Y719	FF	00	00	EAV	80	10	...

Table 17: Explanation to Table 16

Name	Explanation
SAV	start of active video range (see Table 8 to Table 10)
C _B n	U (B – Y) color difference component, pixel number n = 0, 2, 4 to 718
Yn	Y (luminance) component, pixel number n = 0, 1, 2, 3 to 719
C _R n	V (R – Y) color difference component, pixel number n = 0, 2, 4 to 718
EAV	end of active video range (see Table 8 to Table 10)

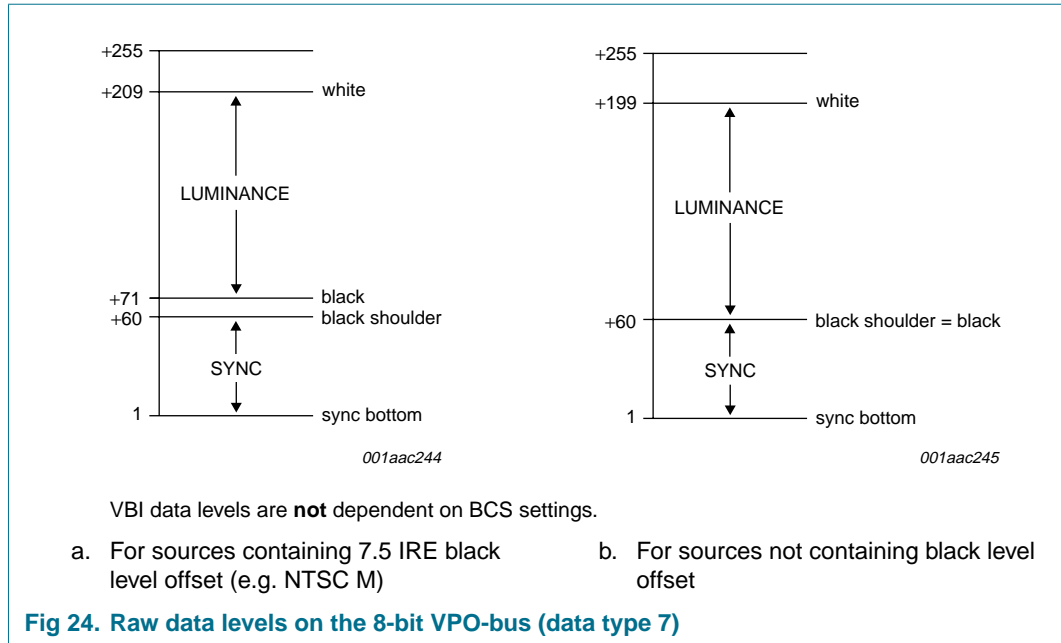

Table 18: Raw data format on the 8-bit VPO-bus (data type 7)

Blanking period			Timing reference code				Oversampled CVBS samples										Timing reference code				Blanking period		
...	80	10	FF	00	00	SAV	Y0	Y1	Y2	Y3	Y4	Y5	...	Yn-1	Yn	FF	00	00	EAV	80	10	...	

Table 19: Explanation to Table 18

Name	Explanation
SAV	start of raw sample range (see Table 8 to Table 10)
Yi	oversampled raw sample stream (CVBS signal), n = 0, 1, 2, 3 to n; n is programmable via HSB and HSS (see Section 9.2.7 and Section 9.2.8)
EAV	end of raw sample range (see Table 8 to Table 10)

Table 20: Sliced data format on the 8-bit VPO-bus (data types 0 to 5 and 8 to 14)

Blanking period			Timing reference code				Internal header				Sliced data				Timing reference code				Blanking period			
...	80	10	FF	00	00	SAV	SDID	DC	IDI1	IDI2	DLN1	DHN1	...	DLNn	DHNn	FF	00	00	EAV	80	10	...

Table 21: Explanation to [Table 20](#)

Name	Explanation
SAV	start of active data (see Table 8 to Table 10)
SDID	sliced data identification: NEP [1] , EP [2] , SDID5 to SDID0, freely programmable via I ² C-bus subaddress 5Eh[5:0], e.g. to be used as source identifier
DC	Dword count: NEP [1] , EP [2] , DC5 to DC0; DC is inserted for software compatibility reasons to SAA7112, but does not represent any relevant information for SAA7113H applications. DC describes the number of succeeding 32-bit words: $DC = \frac{1}{4}(C + n)$, where $C = 2$ (the two data identification bytes IDI1 and IDI2) and $n =$ number of decoded bytes according to the chosen text standard. As the sliced data are transmitted nibble wise, the maximum number of bytes transmitted (NBT) starting at IDI1 results to: $NBS = (DC \times 8) - 2$. DC can vary between 1 and 11, depending on the selected data type. Note that the number of bytes actually transmitted can be less than NBT for two reasons: 1. result of DC would result to a non-integer value (DC is always rounded up) 2. standard not recognized (wrong standard or poor input signal)
IDI1	internal data identification 1: OP [3] , FID (field 1 = 0, field 2 = 1), LineNumber8 to LineNumber3
IDI2	internal data identification 2: OP [3] , LineNumber2 to LineNumber0, DataType3 to DataType0 (see Table 7)
DLNn	sliced data LOW nibble, format: NEP [1] , EP [2] , D3 to D0, 1, 1
DLHn	sliced data HIGH nibble, format: NEP [1] , EP [2] , D7 to D4, 1, 1
EAV	end of active data (see Table 8 to Table 10)

[1] Inverted EP (bit 7); for EP see [Table note 2](#).

[2] Even parity (bit 6) of bits 5 to 0.

[3] Odd parity (bit 7) of bits 6 to 0.

8.11 RTCO output

The real-time control and status output signal contains serial information about the actual system clock (increment of the HPLL), subcarrier frequency, increment and phase (via reset) of the FSC-PLL and PAL sequence bit. The signal can be used for various applications in external circuits, e.g. in a digital encoder to achieve clean encoding. The SAF7113H supports RTC level 3.1 (see external document “*RTC Functional Description*”, available on request).

8.12 RTS0 and RTS1 terminals

These two pins are multifunctional inputs/output controlled by I²C-bus bits RTSE0[3:0] and RTSE1[3:0], located in subaddress 12h (see [Table 50](#) and [Table 51](#)).

The RTS0 terminal can be strapped to ground via a 3.3 kΩ resistor to change the I²C-bus slave address from default 4Ah/4Bh to 48h/49h (the strapping information is read only during the reset sequence).

The RTS1 terminal can be configured as Data Output to 3-state (DOT) input by RTSE1[3:0] = 0000 to control the VPO port (bits 7 to 0) via hardware according to [Table 22](#).

Table 22: Digital output control via RTS1 (enabled by bits RTSE1[3:0] = 0)

Bit OEYC	Pin RTS1 (DOT)	Pins VPO7 to VPO0
0	LOW	Z
1	LOW	active
0	HIGH	Z
1	HIGH	Z

9. I²C-bus description

9.1 I²C-bus format

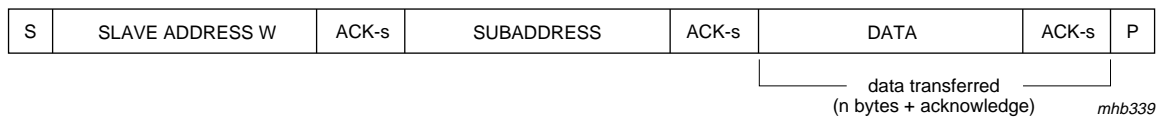

Fig 25. Write procedure

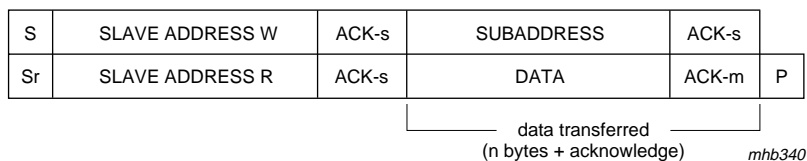

Fig 26. Read procedure (combined format)

Table 23: Description of I²C-bus format [1]

Code	Description
S	START condition
Sr	repeated START condition
Slave address W	0100 1010 (= 4Ah, default) 0100 1000 (= 48h, if pin RTS0 strapped to ground via a 3.3 kΩ resistor)
Slave address R	0100 1011 (= 4Bh, default) 0100 1001 (= 49h, if pin RTS0 strapped to ground via a 3.3 kΩ resistor)
ACK-s	acknowledge generated by the slave
ACK-m	acknowledge generated by the master
Subaddress	subaddress byte (see Table 24)
Data	data byte; see Table note 2
P	STOP condition
X = LSB slave address	read/write control bit; X = 0, order to write (the circuit is slave receiver); X = 1, order to read (the circuit is slave transmitter)

[1] The SAF7113H supports the 'fast mode' I²C-bus specification extension (data rate up to 400 kbit/s).

[2] If more than one byte DATA is transmitted the subaddress pointer is automatically incremented.

9.2 I²C-bus register description

Table 24: Register subaddresses map

Subaddress	Description	Access	Reference
00h	chip version	R	Section 9.2.1
01h to 05h	front-end part	R/W	Section 9.2.2 to Section 9.2.6
06h to 13h	decoder part	R/W	Section 9.2.7 to Section 9.2.20
14h	reserved		
15h to 17h	decoder part	R/W	Section 9.2.21 to Section 9.2.23
18h to 1Eh	reserved		
1Fh	video decoder status byte	R	Section 9.2.24
20h to 3Fh	reserved		
40h to 5Eh	general purpose data slicer	R/W	Section 9.2.25 to Section 9.2.31
5Fh	reserved		
60h to 62h	general purpose data slicer status	R	Section 9.2.32 to Section 9.2.34

Table 25: I²C-bus receiver/transmitter overview

Register function	Subaddress (hex)	D7	D6	D5	D4	D3	D2	D1	D0
Chip version (read only)	00	ID07	ID06	ID05	ID04	-	-	-	-
Increment delay	01	[1]	[1]	[1]	[1]	IDEL3	IDEL2	IDEL1	IDEL0
Analog input control 1	02	FUSE1	FUSE0	GUDL1	GUDL0	MODE3	MODE2	MODE1	MODE0
Analog input control 2	03	[1]	HLNRS	VBSL	WPOFF	HOLDG	GAFIX	GAI28	GAI18
Analog input control 3	04	GAI17	GAI16	GAI15	GAI14	GAI13	GAI12	GAI11	GAI10
Analog input control 4	05	GAI27	GAI26	GAI25	GAI24	GAI23	GAI22	GAI21	GAI20
Horizontal sync start	06	HSB7	HSB6	HSB5	HSB4	HSB3	HSB2	HSB1	HSB0
Horizontal sync stop	07	HSS7	HSS6	HSS5	HSS4	HSS3	HSS2	HSS1	HSS0
Sync control	08	AUFD	FSEL	FOET	HTC1	HTC0	HPLL	VNO11	VNO10
Luminance control	09	BYPS	PREF	BPSS1	BPSS0	VBLB	UPTCV	APER1	APER0
Luminance brightness	0A	BRIG7	BRIG6	BRIG5	BRIG4	BRIG3	BRIG2	BRIG1	BRIG0
Luminance contrast	0B	CONT7	CONT6	CONT5	CONT4	CONT3	CONT2	CONT1	CONT0
Chroma saturation	0C	SATN7	SATN6	SATN5	SATN4	SATN3	SATN2	SATN1	SATN0
Chroma hue control	0D	HUEC7	HUEC6	HUEC5	HUEC4	HUEC3	HUEC2	HUEC1	HUEC0
Chroma control	0E	CDTO	CSTD2	CSTD1	CSTD0	DCCF	FCTC	CHBW1	CHBW0
Chroma gain control	0F	ACGC	CGAIN6	CGAIN5	CGAIN4	CGAIN3	CGAIN2	CGAIN1	CGAIN0
Format/delay control	10	OFTS1	OFTS0	HDEL1	HDEL0	VRLN	YDEL2	YDEL1	YDEL0
Output control 1	11	GPSW1	CM99	GPSW0	HLSEL	OEYC	OERT	VIPB	COLO
Output control 2	12	RTSE13	RTSE12	RTSE11	RTSE10	RTSE03	RTSE02	RTSE01	RTSE00
Output control 3	13	ADLSB	[1]	[1]	OLDSB	FIDP	[1]	AOSL1	AOSL0
Reserved	14	[1]	[1]	[1]	[1]	[1]	[1]	[1]	[1]
V_GATE1_START	15	VSTA7	VSTA6	VSTA5	VSTA4	VSTA3	VSTA2	VSTA1	VSTA0
V_GATE1_STOP	16	VSTO7	VSTO6	VSTO5	VSTO4	VSTO3	VSTO2	VSTO1	VSTO0
V_GATE1_MSB	17	[1]	[1]	[1]	[1]	[1]	[1]	VSTO8	VSTA8
Reserved	18 to 1E	[1]	[1]	[1]	[1]	[1]	[1]	[1]	[1]
Status byte (read only, OLDSB = 0)	1F	INTL	HLVLN	FIDT	GLIMT	GLIMB	WIPA	COPRO	RDCAP
Status byte (read only, OLDSB = 1)	1F	INTL	HLCK	FIDT	GLIMT	GLIMB	WIPA	SLTCA	CODE
Reserved	20 to 3F	[1]	[1]	[1]	[1]	[1]	[1]	[1]	[1]

Table 25: I²C-bus receiver/transmitter overview...continued

Register function	Subaddress (hex)	D7	D6	D5	D4	D3	D2	D1	D0
AC1	40	FISSET	HAM_N	FCE	HUNT_N	[1]	CLKSEL1	CLKSEL0	[1]
LCR2	41	LCR02_7	LCR02_6	LCR02_5	LCR02_4	LCR02_3	LCR02_2	LCR02_1	LCR02_0
LCR3 to LCR23	42 to 56	LCRn_7	LCRn_6	LCRn_5	LCRn_4	LCRn_3	LCRn_2	LCRn_1	LCRn_0
LCR24	57	LCR24_7	LCR24_6	LCR24_5	LCR24_4	LCR24_3	LCR24_2	LCR24_1	LCR24_0
FC	58	FC7	FC6	FC5	FC4	FC3	FC2	FC1	FC0
HOFF	59	HOFF7	HOFF6	HOFF5	HOFF4	HOFF3	HOFF2	HOFF1	HOFF0
VOFF	5A	VOFF7	VOFF6	VOFF5	VOFF4	VOFF3	VOFF2	VOFF1	VOFF0
HVOFF	5B	FOFF	[1]	[1]	VOFF8	[1]	HOFF10	HOFF9	HOFF8
For testability	5C	[1]	[1]	[1]	[1]	[1]	[1]	[1]	[1]
Reserved	5D	[1]	[1]	[1]	[1]	[1]	[1]	[1]	[1]
Sliced data identification code SDID	5E	[1]	[1]	SDID5	SDID4	SDID3	SDID2	SDID1	SDID0
Reserved	5F	[1]	[1]	[1]	[1]	[1]	[1]	[1]	[1]
DR (read only)	60	-	FC8V	FC7V	VPSV	PPV	CCV	-	-
LN1 (read only)	61	-	-	F21_N	LN8	LN7	LN6	LN5	LN4
LN2 (read only)	62	LN3	LN2	LN1	LN0	DT3	DT2	DT1	DT0
Reserved for future extensions	63 to FF	[1]	[1]	[1]	[1]	[1]	[1]	[1]	[1]

[1] All unused control bits must be programmed with logic 0 to ensure compatibility to future enhancements.

9.2.1 Subaddress 00h (read only register)

Table 26: Chip version subaddress 00h (D7 to D4)

Function	Logic levels			
	ID07	ID06	ID05	ID04
Chip Version (CV)	CV3	CV2	CV1	CV0

9.2.2 Subaddress 01h

Table 27: Horizontal increment delay subaddress 01h (D3 to D0)

Function	IDEL3	IDEL2	IDEL1	IDEL0
No update	1	1	1	1
Minimum delay	1	1	1	0
Recommended position	1	0	0	0
Maximum delay	0	0	0	0

The programming of the horizontal increment delay is used to match internal processing delays to the delay of the ADC. Use recommended position only.

9.2.3 Subaddress 02h

Table 28: Analog control 1 subaddress 02h (D3 to D0)

Function ^[1]	Control bits D3 to D0			
	MODE3	MODE2	MODE1	MODE0
Mode 0: CVBS (automatic gain) from AI11 (pin 4)	0	0	0	0
Mode 1: CVBS (automatic gain) from AI12 (pin 7)	0	0	0	1
Mode 2: CVBS (automatic gain) from AI21 (pin 43)	0	0	1	0
Mode 3: CVBS (automatic gain) from AI22 (pin 1)	0	0	1	1
Mode 4: reserved	0	1	0	0
Mode 5: reserved	0	1	0	1
Mode 6 ^[2] : Y (automatic gain) from AI11 (pin 4) + C (gain adjustable via GAI28 to GAI20) from AI21 (pin 43)	0	1	1	0
Mode 7 ^[2] : Y (automatic gain) from AI12 (pin 7) + C (gain adjustable via GAI28 to GAI20) from AI22 (pin 1)	0	1	1	1
Mode 8 ^[2] : Y (automatic gain) from AI11 (pin 4) + C (gain adapted to Y gain) from AI21 (pin 43)	1	0	0	0
Mode 9 ^[2] : Y (automatic gain) from AI12 (pin 7) + C (gain adapted to Y gain) from AI22 (pin 1)	1	0	0	1
Modes 10 to 15: reserved	1	1	1	1

[1] Mode select (see [Figure 27](#) to [Figure 34](#)).

[2] To take full advantage of the YC-modes 6 to 9 the I²C-bus bit BYPS (subaddress 09h, bit 7) should be set to logic 1 (full luminance bandwidth).

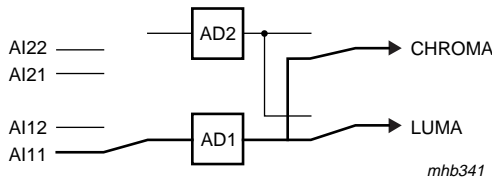

Fig 27. Mode 0; CVBS (automatic gain)

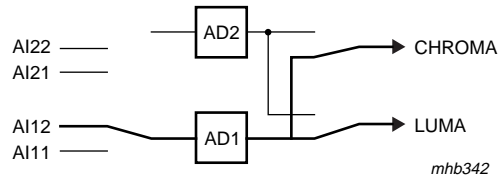

Fig 28. Mode 1; CVBS (automatic gain)

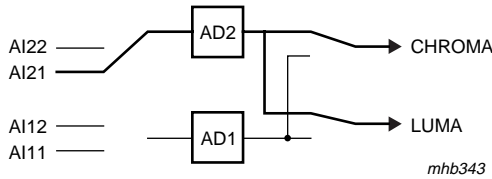

Fig 29. Mode 2; CVBS (automatic gain)

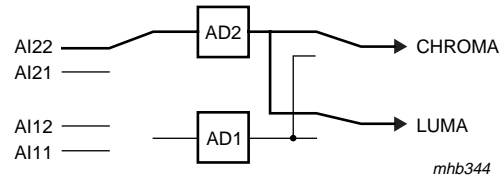
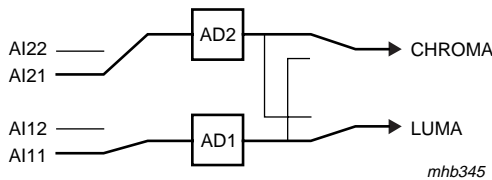
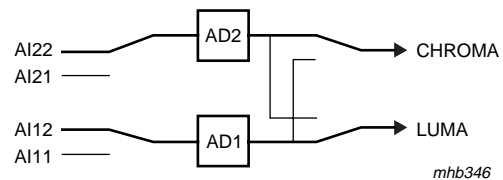

Fig 30. Mode 3; CVBS (automatic gain)



I²C-bus bit BYPS (subaddress 09h, bit 7) should be set to logic 1 (full luminance bandwidth).

Fig 31. Mode 6; Y + C (gain channel 2 adjusted via GAI2)



I²C-bus bit BYPS (subaddress 09h, bit 7) should be set to logic 1 (full luminance bandwidth).

Fig 32. Mode 7; Y + C (gain channel 2 adjusted via GAI2)

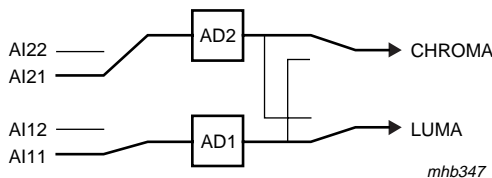

I²C-bus bit BYPS (subaddress 09h, bit 7) should be set to logic 1 (full luminance bandwidth).

Fig 33. Mode 8; Y + C (gain channel 2 adapted to Y gain)

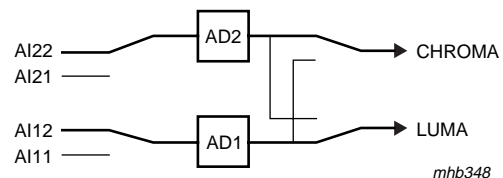

I²C-bus bit BYPS (subaddress 09h, bit 7) should be set to logic 1 (full luminance bandwidth).

Fig 34. Mode 9; Y + C (gain channel 2 adapted to Y gain)

Table 29: Analog control 1 subaddress 02h (D5 and D4) (see Figure 7)

Update hysteresis for 9-bit gain	Control bits D5 and D4	
	GUDL1	GUDL0
Off	0	0
±1 LSB	0	1
±2 LSB	1	0
±3 LSB	1	1

Table 30: Analog control 1 subaddress 02h (D7 and D6) (see Figure 6)

Analog function select FUSE	Control bits D7 and D6	
	FUSE1	FUSE0
Amplifier plus anti-alias filter bypassed	0	0
	0	1
Amplifier active	1	0
Amplifier plus anti-alias filter active	1	1

9.2.4 Subaddress 03h

Table 31: Analog control 2 (AICO2) subaddress 03h

Function	Logic level	Data bit
Static gain control channel 1 (GAI18) (see subaddress 04h)		
Sign bit of gain control	see Table 32	D0
Static gain control channel 2 (GAI28) (see subaddress 05h)		
Sign bit of gain control	see Table 33	D1
Gain control fix (GAFIX)		
Automatic gain controlled by MODE3 to MODE0	0	D2
Gain is user programmable via GAI1 + GAI2	1	D2
Automatic gain control integration (HOLDG)		
AGC active	0	D3
AGC integration hold (freeze)	1	D3
White peak off (WPOFF)		
White peak control active	0	D4
White peak off	1	D4
AGC hold during vertical blanking period (VBSL)		
Short vertical blanking (AGC disabled during equalization and serration pulses)	0	D5
Long vertical blanking (AGC disabled from start of pre-equalization pulses until start of active video (line 22 for 60 Hz, line 24 for 50 Hz))	1	D5
HL not reference select (HLNRS)		
Normal clamping if decoder is in unlocked state	0	D6
Reference select if decoder is in unlocked state	1	D6

9.2.5 Subaddress 04h

Table 32: Gain control analog (AICO3); static gain control channel 1 GAI1 subaddress 04h (D7 to D0)

Decimal value	Gain (dB)	Sign bit	Control bits D7 to D0							
			GAI18	GAI17	GAI16	GAI15	GAI14	GAI13	GAI12	GAI11
0...	≈-3	0	0	0	0	0	0	0	0	0
...117...	≈0	0	0	1	1	1	0	1	0	1
...511	≈6	1	1	1	1	1	1	1	1	1

9.2.6 Subaddress 05h

Table 33: Gain control analog (AICO4); static gain control channel 2 GAI2 subaddress 05h (D7 to D0)

Decimal value	Gain (dB)	Sign bit (subaddress 03h, D1)	Control bits D7 to D0								
		GAI28	GAI27	GAI26	GAI25	GAI24	GAI23	GAI22	GAI21	GAI20	
0...	≈-3	0	0	0	0	0	0	0	0	0	0
...117...	≈0	0	0	1	1	1	1	0	1	0	1
...511	≈6	1	1	1	1	1	1	1	1	1	1

9.2.7 Subaddress 06h

Table 34: Horizontal sync begin subaddress 06h (D7 to D0)

Delay time (step size = 8/LLC)	Control bits D7 to D0							
	HSB7	HSB6	HSB5	HSB4	HSB3	HSB2	HSB1	HSB0
-128...-109 (50 Hz)	forbidden (outside available central counter range)							
-128...-108 (60 Hz)	forbidden (outside available central counter range)							
-108 (50 Hz)...	1	0	0	1	0	1	0	0
-107 (60 Hz)...	1	0	0	1	0	1	0	1
...108 (50 Hz)	0	1	1	0	1	1	0	0
...107 (60 Hz)	0	1	1	0	1	0	1	1
109...127 (50 Hz)	forbidden (outside available central counter range)							
108...127 (60 Hz)	forbidden (outside available central counter range)							
Recommended value for raw data type (see Figure 24)	1	1	1	0	1	0	0	1

9.2.8 Subaddress 07h

Table 35: Horizontal sync stop subaddress 07h (D7 to D0)

Delay time (step size = 8/LLC)	Control bits D7 to D0							
	HSS7	HSS6	HSS5	HSS4	HSS3	HSS2	HSS1	HSS0
-128...-109 (50 Hz)	forbidden (outside available central counter range)							
-128...-108 (60 Hz)	forbidden (outside available central counter range)							
-108 (50 Hz)...	1	0	0	1	0	1	0	0
-107 (60 Hz)...	1	0	0	1	0	1	0	1
...108 (50 Hz)	0	1	1	0	1	1	0	0
...107 (60 Hz)	0	1	1	0	1	0	1	1
109...127 (50 Hz)	forbidden (outside available central counter range)							
108...127 (60 Hz)	forbidden (outside available central counter range)							
Recommended value for raw data type (see Figure 24)	0	0	0	0	1	1	0	1

9.2.9 Subaddress 08h

Table 36: Sync control subaddress 08h (D7 to D5, D3 to D0)

Function	Control bit	Logic level	Data bit
Vertical noise reduction (VNOI)			
Normal mode (recommended setting)	VNOI1	0	D1
	VNOI0	0	D0
Fast mode [applicable for stable sources only; Automatic Field Detection (AUFD) must be disabled]	VNOI1	0	D1
	VNOI0	1	D0
Free running mode	VNOI1	1	D1
	VNOI0	0	D0
Vertical noise reduction bypassed	VNOI1	1	D1
	VNOI0	1	D0
Horizontal PLL (HPLL)			
PLL closed	HPLL	0	D2
PLL open; horizontal frequency fixed	HPLL	1	D2
Horizontal time constant selection (HTC1 and HTC0)			
TV mode (recommended for poor quality TV signals only; do not use for new applications)	HTC1 and HTC0	00	D4 and D3
VTR mode (recommended if a deflection control circuit is directly connected to SAF7113H)	HTC1 and HTC0	01	D4 and D3
Reserved	HTC1 and HTC0	10	D4 and D3
Fast locking mode (recommended setting)	HTC1 and HTC0	11	D4 and D3
Forced ODD/EVEN toggle FOET			
ODD/EVEN signal toggles only with interlaced source	FOET	0	D5
ODD/EVEN signal toggles fieldwise even if source is non-interlaced	FOET	1	D5
Field selection (FSEL)			
50 Hz, 625 lines	FSEL	0	D6
60 Hz, 525 lines	FSEL	1	D6
Automatic field detection (AUFD)			
Field state directly controlled via FSEL	AUFD	0	D7
Automatic field detection	AUFD	1	D7

9.2.10 Subaddress 09h

Table 37: Luminance control subaddress 09h (D7 to D0)

Function	Control bit	Logic level	Data bit
Aperture factor (APER); see Figure 11 to Figure 18			
Aperture factor = 0	APER1	0	D1
	APER0	0	D0
Aperture factor = 0.25	APER1	0	D1
	APER0	1	D0

Table 37: Luminance control subaddress 09h (D7 to D0)...*continued*

Function	Control bit	Logic level	Data bit
Aperture factor = 0.5	APER1	1	D1
	APER0	0	D0
Aperture factor = 1.0	APER1	1	D1
	APER0	1	D0
Update time interval for analog AGC value (UPTCV)			
Horizontal update (once per line)	UPTCV	0	D2
Vertical update (once per field)	UPTCV	1	D2
Vertical blanking luminance bypass (VBLB)			
Active luminance processing	VBLB	0	D3
Chrominance trap and peaking stage are disabled during VBI lines determined by VREF = 0 (see Table 46)	VBLB	1	D3
Aperture band-pass (center frequency) (BPSS)			
Center frequency = 4.1 MHz	BPSS1	0	D5
	BPSS0	0	D4
Center frequency = 3.8 MHz ^[1]	BPSS1	0	D5
	BPSS0	1	D4
Center frequency = 2.6 MHz ^[1]	BPSS1	1	D5
	BPSS0	0	D4
Center frequency = 2.9 MHz ^[1]	BPSS1	1	D5
	BPSS0	1	D4
Prefilter active (PREF); see Figure 11, Figure 12, Figure 14, Figure 16 and Figure 17			
Bypassed	PREF	0	D6
Active	PREF	1	D6
Chrominance trap bypass (BYPS)			
Chrominance trap active; default for CVBS mode	BYPS	0	D7
Chrominance trap bypassed; default for S-video mode	BYPS	1	D7

[1] Not to be used with bypassed chrominance trap.

9.2.11 Subaddress 0Ah

Table 38: Luminance brightness control subaddress 0Ah (D7 to D0)

Offset	Control bits D7 to D0							
	BRIG7	BRIG6	BRIG5	BRIG4	BRIG3	BRIG2	BRIG1	BRIG0
255 (bright)	1	1	1	1	1	1	1	1
128 (ITU level)	1	0	0	0	0	0	0	0
0 (dark)	0	0	0	0	0	0	0	0

9.2.12 Subaddress 0Bh

Table 39: Luminance contrast control subaddress 0Bh (D7 to D0)

Gain	Control bits D7 to D0							
	CONT7	CONT6	CONT5	CONT4	CONT3	CONT2	CONT1	CONT0
1.999 (maximum)	0	1	1	1	1	1	1	1
1.109 (ITU level)	0	1	0	0	0	1	1	1
1.0	0	1	0	0	0	0	0	0
0 (luminance off)	0	0	0	0	0	0	0	0
-1 (inverse luminance)	1	1	0	0	0	0	0	0
-2 (inverse luminance)	1	0	0	0	0	0	0	0

9.2.13 Subaddress 0Ch

Table 40: Chrominance saturation control subaddress 0Ch (D7 to D0)

Gain	Control bits D7 to D0							
	SATN7	SATN6	SATN5	SATN4	SATN3	SATN2	SATN1	SATN0
1.999 (maximum)	0	1	1	1	1	1	1	1
1.0 (ITU level)	0	1	0	0	0	0	0	0
0 (color off)	0	0	0	0	0	0	0	0
-1 (inverse chrominance)	1	1	0	0	0	0	0	0
-2 (inverse chrominance)	1	0	0	0	0	0	0	0

9.2.14 Subaddress 0Dh

Table 41: Chrominance hue control subaddress 0Dh (D7 to D0)

Hue phase (deg)	Control bits D7 to D0							
	HUEC7	HUEC6	HUEC5	HUEC4	HUEC3	HUEC2	HUEC1	HUEC0
+178.6...	0	1	1	1	1	1	1	1
...0...	0	0	0	0	0	0	0	0
...-180	1	0	0	0	0	0	0	0

9.2.15 Subaddress 0Eh

Table 42: Chrominance control subaddress 0Eh

Function	Control bit	Logic level	Data bit
50 Hz	60 Hz		
Chrominance bandwidth (CHBW0 and CHBW1)			
Small bandwidth (\approx 620 kHz)	CHBW1	0	D1
	CHBW0	0	D0
Nominal bandwidth (\approx 800 kHz)	CHBW1	0	D1
	CHBW0	1	D0
Medium bandwidth (\approx 920 kHz)	CHBW1	1	D1
	CHBW0	0	D0
Wide bandwidth (\approx 1000 kHz)	CHBW1	1	D1
	CHBW0	1	D0

Table 42: Chrominance control subaddress 0Eh...continued

Function		Control bit	Logic level	Data bit
50 Hz	60 Hz			
Fast color time constant (FCTC)				
Nominal time constant		FCTC	0	D2
Fast time constant		FCTC	1	D2
Disable chrominance comb filter (DCCF)				
Chrominance comb filter on (during lines determined by VREF = 1; see Table 46)		DCCF	0	D3
Chrominance comb filter permanently off		DCCF	1	D3
Color standard selection (CSTD0 to CSTD2); logic levels 100, 110 and 111 are reserved, do not use				
PAL BGHIN	NTSC M (or NTSC-Japan with special level adjustment: brightness subaddress 0Ah = 95h; contrast subaddress 0Bh = 48h)	CSTD2	0	D6
		CSTD1	0	D5
		CSTD0	0	D4
NTSC 4.43 (50 Hz)	PAL 4.43 (60 Hz)	CSTD2	0	D6
		CSTD1	0	D5
		CSTD0	1	D4
Combination-PAL N	NTSC 4.43 (60 Hz)	CSTD2	0	D6
		CSTD1	1	D5
		CSTD0	0	D4
NTSC N	PAL M	CSTD2	0	D6
		CSTD1	1	D5
		CSTD0	1	D4
SECAM	reserved	CSTD2	1	D6
		CSTD1	0	D5
		CSTD0	1	D4
Clear DTO (CDTO)				
Disabled		CDTO	0	D7
Every time CDTO is set, the internal subcarrier DTO phase is reset to 0° and the RTCO output generates a logic 0 at time slot 68 (see external document "RTC Functional Description", available on request). So an identical subcarrier phase can be generated by an external device (e.g. an encoder).		CDTO	1	D7

9.2.16 Subaddress 0Fh

Table 43: Chrominance gain control subaddress 0Fh (D6 to D0)

Chrominance gain value (if ACGC is set to logic 1)	Control bits D6 to D0						
	CGAIN6	CGAIN5	CGAIN4	CGAIN3	CGAIN2	CGAIN1	CGAIN0
Minimum gain (0.5)	0	0	0	0	0	0	0
Nominal gain (1.125)	0	1	0	0	1	0	0
Maximum gain (7.5)	1	1	1	1	1	1	1

Table 44: Chrominance gain control subaddress 0Fh (D7)

Automatic chrominance gain control ACGC	Control bit D7
	ACGC
On	0
Programmable gain via CGAIN6 to CGAIN0	1

9.2.17 Subaddress 10h

Table 45: Format/delay control subaddress 10h (D2 to D0)

Luminance delay compensation (steps in 2/LLC)	Control bits D2 to D0		
	YDEL2	YDEL1	YDEL0
-4...	1	0	0
...0...	0	0	0
...3	0	1	1

Table 46: VREF pulse position and length VRLN subaddress 10h (D3)

Control bit D3	VREF at 60 Hz 525 lines				VREF at 50 Hz 625 lines			
	0		1		0		1	
VRLN	0		1		0		1	
Length	240		242		286		288	
Line number	first	last	first	last	first	last	first	last
Field 1 [1]	19 (22)	258 (261)	18 (21)	259 (262)	24	309	23	310
Field 2 [1]	282 (285)	521 (524)	281 (284)	522 (525)	337	622	336	623

[1] The numbers given in parenthesis refer to ITU line counting.

Table 47: Fine position of HS HDEL0 and HDEL1 subaddress 10h (D5 and D4)

Fine position of HS (steps in 2/LLC)	Control bits D5 and D4	
	HDEL1	HDEL0
0	0	0
1	0	1
2	1	0
3	1	1

Table 48: Output format selection OFTS0 and OFTS1 subaddress 10h (D7 and D6); see Table 9 and Table 10

V-flag generation in SAV/EAV-codes	Control bits D7 and D6	
	OFTS1	OFTS0
Standard ITU-R BT 656 format	0	0
V-flag in SAV/EAV is generated by VREF	0	1
V-flag in SAV/EAV is generated by data-type	1	0
Reserved	1	1

9.2.18 Subaddress 11h

Table 49: Output control 1 subaddress 11h

Function	Bit	Logic level	Data bit
Color on (COLO)			
Automatic color killer	COLO	0	D0
Color forced on	COLO	1	D0
YUV decoder bypassed (VIPB)			
Processed data to VPO output	VIPB	0	D1
ADC data to VPO output; dependent on mode settings	VIPB	1	D1
Output enable real-time (OERT)			
RTS0, RTS1, RTCO high-impedance inputs	OERT	0	D2
RTS0, RTCO active, RTS1 active, if RTSE13 to RTSE10 = 0000	OERT	1	D2
Output enable YUV data (OEYC)			
VPO-bus high-impedance	OEYC	0	D3
Output VPO-bus active or controlled by RTS1 (see Table 22)	OEYC	1	D3
Selection of horizontal lock indicator for RTS0 and RTS1 outputs			
Standard horizontal lock indicator (low-passed)	HLSEL	0	D4
Fast lock indicator (use is recommended only for high performance input signals)	HLSEL	1	D4
General purpose switch [available on pin RTS0, if control bits RTSE03 to RTSE00 (subaddress 12h) is set to 0010]			
LOW	GPSW0	0	D5
HIGH	GPSW0	1	D5
CM99 compatibility to SAA7199 (CM99)			
Default value	CM99	0	D6
To be set only if SAA7199 (digital encoder) is used for re-encoding in conjunction with RTCO	CM99	1	D6
General purpose switch [available on pin RTS1, if control bits RTSE13 to RTSE10 (subaddress 12h) is set to 0010]			
LOW	GPSW1	0	D7
HIGH	GPSW1	1	D7

9.2.19 Subaddress 12h

Table 50: RTS0 output control subaddress 12h

RTS0 output control	Control bits D3 to D0			
	RTSE03	RTSE02	RTSE01	RTSE00
Reserved	0	0	0	0
VIPB (subaddress 11h, bit 1) = 0: reserved	0	0	0	1
VIPB (subaddress 11h, bit 1) = 1: LSBs of the 9-bit ADCs				
GPSW0 level (subaddress 11h, bit 5)	0	0	1	0

Table 50: RTS0 output control subaddress 12h...continued

RTS0 output control	Control bits D3 to D0			
	RTSE03	RTSE02	RTSE01	RTSE00
Horizontal Lock (HL) indicator; selectable via HLSEL (subaddress 11h, bit 4) <ul style="list-style-type: none"> HSEL = 0: standard horizontal lock indicator HSEL = 1: fast horizontal lock indicator (use is not recommended for sources with unstable timebase e.g. VCRs) 	0	0	1	1
VL (vertical and horizontal lock)	0	1	0	0
DL (vertical and horizontal lock and color detected)	0	1	0	1
PLIN (PAL/SECAM sequence; LOW: PAL/DR line is present)	0	1	1	0
HREF_HS, horizontal reference signal: indicates valid data on the VPO-bus. The positive slope marks the beginning of a new active line. The pulse width is dependent on the data type selected by the control registers LCR2 to LCR24 (subaddress 41h to 57h; see Table 7 and Table 62) <ul style="list-style-type: none"> data type 0 to 6, 8 to 15: HIGH period 1440 LLC-cycles (720 samples; see Figure 37) data type 7 (upsampled raw data): HIGH period programmable in LLC8 steps via HSB7 to HSB0, HSS7 to HSS0 (subaddress 06h and 07h), fine position adjustment via HDEL1 to HDEL0 (subaddress 10h, bits 5 and 4) 	0	1	1	1
HS, programmable width in LLC8 steps via HSB7 to HSB0 and HSS7 to HSS0 (subaddress 06h and 07h), fine position adjustment in LLC2 steps via HDEL1 to HDEL0 (subaddress 10h, bits 5 and 4)	1	0	0	0
HQ (HREF gated with VREF)	1	0	0	1
ODD, field identifier; HIGH = odd field; see vertical timing diagrams Figure 38 and Figure 39	1	0	1	0
VS (vertical sync; see vertical timing diagrams Figure 38 and Figure 39)	1	0	1	1
V123 (vertical pulse; see vertical timing diagrams Figure 38 and Figure 39)	1	1	0	0
VGATE (programmable via VSTA8 to VSTA0 and VSTO8 to VSTO0, subaddresses 15h, 16h and 17h)	1	1	0	1
VREF (programmable in two positions via VRLN, subaddress 10h, bit 3)	1	1	1	0
FID (position and polarity programmable via VSTA8 to VSTA0, subaddresses 15h and 17h and FIDP, subaddress 13h, bit 3)	1	1	1	1

Table 51: RTS1 output control subaddress 12h

RTS1 output control	Control bits D7 to D4			
	RTSE13	RTSE12	RTSE11	RTSE10
3-state, pin RTS1 is used as DOT input (see Table 22)	0	0	0	0
VIPB (subaddress 11h, bit 1) = 0: reserved	0	0	0	1
VIPB (subaddress 11h, bit 1) = 1: LSBs of the 9-bit ADCs				
GPSW1	0	0	1	0
Horizontal Lock (HL) indicator; selectable via HLSEL (subaddress 11h, bit 4)	0	0	1	1
<ul style="list-style-type: none"> HLSEL = 0: standard horizontal lock indicator HLSEL = 1: fast horizontal lock indicator (use is not recommended for sources with unstable timebase e.g. VCRs) 				
VL (vertical and horizontal lock)	0	1	0	0
DL (vertical and horizontal lock and color detected)	0	1	0	1
PLIN (PAL/SECAM sequence; LOW: PAL/DR line is present)	0	1	1	0
HREF_HS, horizontal reference signal: indicates valid data on the VPO-bus. The positive slope marks the beginning of a new active line. The pulse width is dependent on the data type selected by the control registers LCR2 to LCR24 (subaddress 41h to 57h; see Table 7 and Table 62)	0	1	1	1
<ul style="list-style-type: none"> data type 0 to 6, 8 to 15: HIGH period 1440 LLC-cycles (720 samples; see Figure 37) data type 7 (upsampled raw data): HIGH period programmable in LLC8 steps via HSB7 to HSB0, HSS7 to HSS0 (subaddress 06h and 07h), fine position adjustment via HDEL1 to HDEL0 (subaddress 10h, bits 5 and 4) 				
HS, programmable width in LLC8 steps via HSB7 to HSB0 and HSS7 to HSS0 (subaddress 06h and 07h), fine position adjustment in LLC2 steps via HDEL1 to HDEL0 (subaddress 10h, bits 5 and 4)	1	0	0	0
HQ (HREF gated with VREF)	1	0	0	1
ODD, field identifier; HIGH = odd field; see vertical timing diagrams Figure 38 and Figure 39	1	0	1	0
VS (vertical sync); see vertical timing diagrams Figure 38 and Figure 39	1	0	1	1
V123 (vertical pulse); see vertical timing diagrams Figure 38 and Figure 39	1	1	0	0
VGATE (programmable via VSTA8 to VSTA0 and VSTO8 to VSTO0, subaddresses 15h, 16h and 17h)	1	1	0	1
VREF (programmable in two positions via VRLN, subaddress 10h, bit 3)	1	1	1	0
FID (position and polarity programmable via VSTA 8 to VSTA0, subaddresses 15h and 17h and FIDP, subaddress 13h, bit 3)	1	1	1	1

9.2.20 Subaddress 13h

Table 52: Output control subaddress 13h (D7, D4, D3, D1 and D0)

Function	Bit	Logic level	Data bit
Analog test select (AOSL)			
AOUT connected to internal test point 1	AOSL1	0	D1
	AOSL0	0	D0
AOUT connected to input AD1	AOSL1	0	D1
	AOSL0	1	D0
AOUT connected to input AD2	AOSL1	1	D1
	AOSL0	0	D0
AOUT connected to internal test point 2	AOSL1	1	D1
	AOSL0	1	D0
Field ID polarity if selected on RTS1 or RTS0 outputs if RTSE1 and RTSE0 (subaddress 12h) are set to 1111			
Default	FIDP	0	D3
Inverted	FIDP	1	D3
Selection bit for status byte functionality OLDSB			
Default status information (see Table 56)	OLDSB	0	D4
Old status information, for compatibility reasons (see Table 56)	OLDSB	1	D4
Analog-to-digital converter output bits on VPO7 to VPO0 in bypass mode (VIPB = 1, used for test purposes) ADLSB [1]			
AD8 to AD1 (MSBs) on VPO7 to VPO0	ADLSB	0	D7
AD7 to AD0 (LSBs) on VPO7 to VPO0	ADLSB	1	D7

[1] Analog-to-digital converter selection via MODE3 to MODE0 (subaddress 02h; see [Figure 27](#) to [Figure 30](#)).

9.2.21 Subaddress 15h

Table 53: Start of VGATE pulse (01-transition) and polarity change of FID pulse

Field	Frame line counting	Decimal value	MSB (subaddress 17, D0)	Control bits D7 to D0								
				VSTA8	VSTA7	VSTA6	VSTA5	VSTA4	VSTA3	VSTA2	VSTA1	VSTA0
50 Hz	1st	1	312	1	0	0	1	1	1	0	0	0
	2nd	314										
	1st	2	0...	0	0	0	0	0	0	0	0	0
	2nd	315										
60 Hz	1st	312	...310	1	0	0	1	1	0	1	1	1
	2nd	625										
	1st	4	262	1	0	0	0	0	0	1	1	0
	2nd	267										
60 Hz	1st	5	0...	0	0	0	0	0	0	0	0	0
	2nd	268										
	1st	265	...260	1	0	0	0	0	0	1	0	1
	2nd	3										

9.2.22 Subaddress 16h

Table 54: Stop of VGATE pulse (10-transition)

Field	Frame line counting		Decimal value	MSB (subaddress 17, D0)	Control bits D7 to D0							
				VSTO8	VSTO7	VSTO6	VSTO5	VSTO4	VSTO3	VSTO2	VSTO1	VSTO0
50 Hz	1st	1	312	1	0	0	1	1	1	0	0	0
	2nd	314										
	1st	2	0...	0	0	0	0	0	0	0	0	0
	2nd	315										
	1st	312	...310	1	0	0	1	1	0	1	1	1
	2nd	625										
60 Hz	1st	4	262	1	0	0	0	0	0	1	1	0
	2nd	267										
	1st	5	0...	0	0	0	0	0	0	0	0	0
	2nd	268										
	1st	265	...260	1	0	0	0	0	0	1	0	1
	2nd	3										

9.2.23 Subaddress 17h

Table 55: VGATE MSBs

Function	Logic level	Control bit
VSTA8, see subaddress 15		
MSB VGATE start	see Table 53	D0
VSTO8, see subaddress 16		
MSB VGATE stop	see Table 54	D1

9.2.24 Subaddress 1Fh (read only register)

Table 56: Status byte video decoder subaddress 1Fh

I ² C-bus control bit	Function	Data bit
RDCAP	ready for capture (all internal loops locked); active HIGH (OLDSB = 0)	D0
CODE	color signal in accordance with selected standard has been detected; active HIGH (OLDSB = 1)	
COPRO	copy protected source detected according to Macrovision version up to 7.01 (OLDSB = 0)	D1
SLTCA	slow time constant active in WIPA mode; active HIGH (OLDSB = 1)	
WIPA	white peak loop is activated; active HIGH	D2
GLIMB	gain value for active luminance channel is limited [min (bottom)]; active HIGH	D3
GLIMT	gain value for active luminance channel is limited [max (top)]; active HIGH	D4
FIDT	identification bit for detected field frequency; LOW = 50 Hz, HIGH = 60 Hz	D5

Table 56: Status byte video decoder subaddress 1Fh...continued

I ² C-bus control bit	Function	Data bit
HLVLN	status bit for horizontal/vertical loop: LOW = locked, HIGH = unlocked (OLDSB = 0)	D6
HLCK	status bit for locked horizontal frequency; LOW = locked, HIGH = unlocked (OLDSB = 1)	
INTL	status bit for interlace detection; LOW = non-interlaced, HIGH = interlaced	D7

9.2.25 Subaddress 40h

Table 57: Data slicer clock selection

Slicer set (40h)	Control bits D2 and D1	
	CLKSEL1	CLKSEL0
Reserved	0	0
13.5 MHz (default)	0	1
Reserved	1	0
Reserved	1	1

Table 58: Amplitude searching

Slicer set (40h)	Control bit D4
Amplitude searching	HUNT_N
Amplitude searching active (default)	0
Amplitude searching stopped	1

Table 59: Framing code error

Slicer set (40h)	Control bit D5
Framing code error	FCE
One framing code error allowed	0
No framing code errors allowed	1

Table 60: Hamming check

Slicer set (40h)	Control bit D6
Hamming check	HAM_N
Hamming check for 2 bytes after framing code, dependent on data type (default)	0
No Hamming check	1

Table 61: Field size select

Slicer set (40h)	Control bit D7
Field size select	FISET
50 Hz field rate	0
60 Hz field rate	1

9.2.26 Subaddresses 41h to 57h

Table 62: LCR register 2 to 24 (subaddresses 41h to 57h); see Table 7

LCR register 2 to 24 (subaddresses 41h to 57h)		Framing code	D7 to D4	D3 to D0
			DT3 to DT0 [1]	DT3 to DT0 [1]
WST625	teletext EuroWST, CCST	27h	0000	0000
CC625	European closed caption	001	0001	0001
VPS	video programming service	9951h	0010	0010
WSS	wide screen signalling bits	1E3C1Fh	0011	0011
WST525	US teletext (WST)	27h	0100	0100
CC525	US closed caption (line 21)	001	0101	0101
Test line	video component signal, VBI region	-	0110	0110
Intercast	oversampled CVBS data	-	0111	0111
General text	teletext	programmable	1000	1000
VITC625	VITC/EBU time codes (Europe)	programmable	1001	1001
	VITC/SMPTE time codes (USA)	programmable	1010	1010
Reserved	-	-	1011	1011
NABTS	US NABTS	-	1100	1100
Japtext	MOJI (Japanese)	programmable (A7h)	1101	1101
JFS	Japanese format switch (L20/22)	programmable	1110	1110
Active video	video component signal, active video region (default)	-	1111	1111

[1] The assignment of the upper and lower nibbles to the corresponding field depends on the setting of FOFF (subaddress 5Bh, bit 7); see Table 63.

Table 63: Setting of FOFF

FOFF	D7 to D4	D3 to D0
0	field 1	field 2
1	field 2	field 1

9.2.27 Subaddress 58h

Table 64: Framing code for programmable data types

Slicer set (subaddress 58h)	Control bits D7 to D0
Programmable framing code	FC7 to FC0
Default	40h

9.2.28 Subaddress 59h

Table 65: Horizontal offset

Slicer set (subaddresses 59h and 5Bh)	Control bits address 5Bh, data bits D2 to D0	Control bits address 59h, data bits D7 to D0
Horizontal offset	HOFF10 to HOFF8	HOFF7 to HOFF0
Recommended value	3h	54h

9.2.29 Subaddress 5Ah

Table 66: Vertical offset

Slicer set (subaddresses 5Ah and 5Bh)	Control bit address 5Bh, data bit D4	Control bits address 5Ah, data bits D7 to D0
Vertical offset	VOFF8	VOFF7 to VOFF0
Minimum value 0	0	0h
Maximum value 312	1	38h
Value for 50 Hz 625 lines input	0	07h
Value for 60 Hz 525 lines input	0	0Ah

9.2.30 Subaddress 5Bh

Table 67: Field offset, MSBs for vertical and horizontal offsets

Slicer set (subaddress 5Bh)	Control bit D7
Field offset	FOFF
No modification of internal field indicator	0
Invert field indicator (even/odd; default)	1

9.2.31 Subaddress 5Eh

Table 68: SDID codes

Slicer set (subaddress 5Eh)	D5	D4	D3	D2	D1	D0
SDID codes	SDID5	SDID4	SDID3	SDID2	SDID1	SDID0
SDID5 to SDID0 = 0h (default)	0	0	0	0	0	0

9.2.32 Subaddress 60h (read only register)

Table 69: Slicer status bit (subaddress 60h) read only

Slicer status bit (subaddress 60h) read only	Control bit D2
Closed caption valid	CCV
No closed caption in the last frame	0
Closed caption detected	1

Table 70: Slicer status bit (subaddress 60h) read only

Slicer status bit (subaddress 60h) read only	Control bit D3
PALplus valid	PPV
No PALplus in the last frame	0
PALplus detected	1

Table 71: Slicer status bit (subaddress 60h) read only

Slicer status bit (subaddress 60h) read only	Control bit D4
VPS valid	VPSV
No VPS in the last frame	0
VPS detected	1

Table 72: Slicer status bit (subaddress 60h) read only

Slicer status bit (subaddress 60h) read only	Control bits D6 and D5	
Framing code valid	FC8V	FC7V
No framing code in the last frame	0	0
Framing code with 1 error detected in the last frame	0	1
Framing code without errors detected in the last frame	1	X [1]

[1] X = don't care.

9.2.33 Subaddress 61h (read only register)

Table 73: Slicer status bits (subaddresses 61h and 62h) read only

Slicer status bits (subaddresses 61h and 62h) read only	Subaddress 61h, data bits D4 to D0	Subaddress 62h, data bits D7 to D4
Line number	LN8 to LN4	LN3 to LN0

9.2.34 Subaddress 62h (read only register)

Table 74: Slicer status bits (subaddress 62h) read only

Slicer status bits (subaddress 62h) read only	Control bits D3 to D0
Data type according to Table 7	DT3 to DT0

9.3 I²C-bus start setup

The given values force the following behavior of the SAF7113H:

- The analog input AI11 expects a signal in CVBS format; analog anti-alias filter and AGC active
- Automatic field detection enabled, PAL BDGHI or NTSC M standard expected
- Standard ITU-R BT 656 output format enabled, VBI data slicer disabled (see [Table 75](#), [Table note 2](#))
- Contrast, brightness and saturation control in accordance with ITU standards
- Chrominance processing with nominal bandwidth (800 kHz).

Table 75: I²C-bus start setup values

Subaddress (hexadecimal)	Function	Name [1]	Values (binary)								Start (hexadecimal)	
			7	6	5	4	3	2	1	0		
00	chip version	ID07 to ID04	read only									
01	increment delay	X, X, X, X, IDEL[3:0]	0	0	0	0	1	0	0	0	0	08
02	analog input control 1	FUSE[1:0], GUDL[1:0], MODE[3:0]	1	1	0	0	0	0	0	0	0	C0

Table 75: I²C-bus start setup values...continued

Subaddress (hexadecimal)	Function	Name [1]	Values (binary)								Start (hexadecimal)
			7	6	5	4	3	2	1	0	
03	analog input control 2	X, HLNRS, VBSL, WPOFF, HOLDG, GAFIX, GAI28, GAI18	0	0	1	1	0	0	1	1	33
04	analog input control 3	GAI1[7:0]	0	0	0	0	0	0	0	0	00
05	analog input control 4	GAI2[7:0]	0	0	0	0	0	0	0	0	00
06	horizontal sync start	HSB[7:0]	1	1	1	0	1	0	0	1	E9
07	horizontal sync stop	HSS[7:0]	0	0	0	0	1	1	0	1	0D
08	sync control	AUFD, FSEL, FOET, HTC[1:0], HPLL, VNOI[1:0]	1	0	0	1	1	0	0	0	98
09	luminance control	BYPS, PREF, BPSS[1:0], VBLB, UPTCV, APER[1:0]	0	0	0	0	0	0	0	1	01
0A	luminance brightness	BRIG[7:0]	1	0	0	0	0	0	0	0	80
0B	luminance contrast	CONT[7:0]	0	1	0	0	0	1	1	1	47
0C	chrominance saturation	SATN[7:0]	0	1	0	0	0	0	0	0	40
0D	chrominance hue control	HUEC[7:0]	0	0	0	0	0	0	0	0	00
0E	chrominance control	CDTO, CSTD[2:0], DCCF, FCTC, CHBW[1:0]	0	0	0	0	0	0	0	1	01
0F	chrominance gain control	ACGC, CGAIN[6:0]	0	0	1	0	1	0	1	0	2A
10	format/delay control	OFTS[1:0], HDEL[1:0], VRLN, YDEL[2:0]	0	0	0	0	0	0	0	0	00
11	output control 1	GPSW1, CM99, GPSW0, HLSEL, OEYC, OERT, VIPB, COLO	0	0	0	0	1	1	0	0	0C
12	output control 2	RTSE1[3:0], RTSE0[3:0]	0	0	0	0	0	0	0	1	01
13	output control 3	ADLSB, X, X, OLDSB, FIDP, X, AOSL[1:0]	0	0	0	0	0	0	0	0	00
14	reserved		0	0	0	0	0	0	0	0	00
15	VGATE start	VSTA[7:0]	0	0	0	0	0	0	0	0	00
16	VGATE stop	VSTO[7:0]	0	0	0	0	0	0	0	0	00
17	MSBs for VGATE control	X, X, X, X, X, X, VSTO8, VSTA8	0	0	0	0	0	0	0	0	00
18 to 1E	reserved		0	0	0	0	0	0	0	0	00
1F	decoder status byte	INTL, HLVLN, FIDT, GLIMIT, GLIMB, WIPA, COPRO, RDCAP	read only								
20 to 3F	reserved		0	0	0	0	0	0	0	0	00
40	slicer control 1	FISSET, HAM_N, FCE, HUNT_N, X, CLKSEL[1:0], X	0	0	0	0	0	0	1	0	02 [2]
41 to 57	line control register 2 to 24	LCRn[7:0]	1	1	1	1	1	1	1	1	FF [2]
58	programmable framing code	FC[7:0]	0	0	0	0	0	0	0	0	00
59	horizontal offset for slicer	HOFF[7:0]	0	1	0	1	0	1	0	0	54 [2]

Table 75: I²C-bus start setup values...continued

Subaddress (hexadecimal)	Function	Name [1]	Values (binary)								Start (hexadecimal)
			7	6	5	4	3	2	1	0	
5A	vertical offset for slicer	VOFF[7:0]	0	0	0	0	0	1	1	1	07 [2]
5B	field offset and MSBs for horizontal and vertical offset	FOFF, X, X, VOFF8, X, HOFF[10:8]	1	0	0	0	0	0	1	1	83 [2]
5C and 5D	reserved		0	0	0	0	0	0	0	0	00
5E	sliced data identification code	X, X, SDID[5:0]	0	0	0	0	0	0	0	0	00
5F	reserved		0	0	0	0	0	0	0	0	00
60	slicer status byte 1	-, FC8V, FC7V, VPSV, PPV, CCV, -, -	read only								
61	slicer status byte 2	-, -, F21_N, LN[8:4]	read only								
62	slicer status byte 2	LN[3:0], DT[3:0]	read only								

- [1] All X values must be set to logic 0. For SECAM decoding set register 0Eh to 50h.
- [2] For proper data slicer programming refer to [Table 7](#), [Table 11](#), [Table 12](#), [Table 13](#) and [Table 14](#).

10. Limiting values

Table 76: Limiting values

In accordance with the Absolute Maximum Rating System (IEC 60134). All ground pins connected together and all supply pins connected together.

Symbol	Parameter	Conditions	Min	Max	Unit
V _{DDD}	digital supply voltage		-0.5	+4.6	V
V _{DDA}	analog supply voltage		-0.5	+4.6	V
V _{i(a)}	analog input voltage		[1] -0.5	V _{DDA} + 0.5	V
V _{o(a)}	analog output voltage		-0.5	V _{DDA} + 0.5	V
V _{i(n)}	input voltage at pins XTALI, SDA and SCL		-0.5	V _{DDD} + 0.5	V
V _{i(d)}	digital input voltage	outputs in 3-state	-0.5	+4.6	V
		outputs in 3-state	[2] -0.5	+5.5	V
V _{o(d)}	digital output voltage	outputs active	-0.5	V _{DDD} + 0.5	V
ΔV _{SS}	voltage difference between V _{SSA(all)} and V _{SS(all)}		-	100	mV
T _{stg}	storage temperature		-65	+150	°C
T _{amb}	ambient temperature		-40	+85	°C
V _{esd}	electrostatic discharge voltage	human body model	[3] -	±2000	V
		machine model	[4] -	±150	V

- [1] Maximum value is 4.6 V.
- [2] Condition for maximum voltage at digital inputs or I/O pins: 3.0 V < V_{DDD} < 3.6 V.
- [3] Class 2 according to JESD22-A114-B.
- [4] Class A according to EIA/JESD22-A115-A.

11. Thermal characteristics

Table 77: Thermal characteristics

Symbol	Parameter	Conditions	Typ	Unit
$R_{th(j-a)}$	thermal resistance from junction to ambient	in free air	[1] 53	K/W

- [1] The overall $R_{th(j-a)}$ value can vary depending on the board layout. To minimize the effective $R_{th(j-a)}$ all power and ground pins must be connected to the power and ground layers directly. An ample copper area direct under the SAF7113H with a number of through-hole plating, which connect to the ground layer (four-layer board: second layer), can also reduce the effective $R_{th(j-a)}$. Please do not use any solder-stop varnish under the chip. In addition the usage of soldering glue with a high thermal conductance after curing is recommended.

12. Characteristics

Table 78: Characteristics

$V_{DDD} = 3.0\text{ V to }3.6\text{ V}$; $V_{DDA} = 3.1\text{ V to }3.5\text{ V}$; $T_{amb} = 25\text{ }^{\circ}\text{C}$; unless otherwise specified.

Symbol	Parameter	Conditions	Min	Typ	Max	Unit
Supplies						
V_{DDD}	digital supply voltage		3.0	3.3	3.6	V
I_{DDD}	digital supply current		[1] 28	32	42	mA
P_D	digital power dissipation		[1] 0.08	0.10	0.15	W
V_{DDA}	analog supply voltage	$V_{DDA} \leq V_{DDD} + 200\text{ mV}$	3.1	3.3	3.5	V
I_{DDA}	analog supply current	bits AOSL[1:0] = 00	[1] 64	73	82	mA
P_A	analog power dissipation		[1] 0.20	0.24	0.29	W
P_{A+D}	analog plus digital power dissipation		[1] 0.28	0.34	0.44	W
$P_{A+D(pd)}$	analog plus digital power dissipation	pin CE connected to ground; power-down mode	-	0.07	-	W
Analog part						
I_{clamp}	clamping current	$V_I = 0.9\text{ V (DC)}$	-	± 8	-	μA
$V_{i(p-p)}$	input voltage (peak-to-peak value)	for normal video levels 1 V (p-p), termination 18/56 Ω and AC coupling required; coupling capacitor = 47 nF	0.5	0.7	1.4	V
$ Z_i $	input impedance	clamping current off	200	-	-	k Ω
C_i	input capacitance		-	-	10	pF
α_{cs}	channel crosstalk	$f_i = 5\text{ MHz}$	-	-	-50	dB
9-bit analog-to-digital converters						
B	bandwidth	at -3 dB	-	7	-	MHz
ϕ_{diff}	differential phase	amplifier plus anti-alias filter bypassed	-	2	-	deg
G_{diff}	differential gain	amplifier plus anti-alias filter bypassed	-	2	-	%
$f_{clk(ADC)}$	ADC clock frequency		12.8	-	14.3	MHz
DLE	DC differential linearity error		-	0.7	-	LSB
ILE	DC integral linearity error		-	1	-	LSB

Table 78: Characteristics...*continued* $V_{DD} = 3.0\text{ V to }3.6\text{ V}$; $V_{DDA} = 3.1\text{ V to }3.5\text{ V}$; $T_{amb} = 25\text{ }^\circ\text{C}$; unless otherwise specified.

Symbol	Parameter	Conditions	Min	Typ	Max	Unit
Digital inputs						
V_{IL}	LOW-level input voltage on					
	pins SDA and SCL		[2] -0.5	-	+0.3 $V_{DD(I2C)}$	V
	pin XTALI		-0.3	-	+0.8	V
	pins for all other inputs		-0.3	-	+0.8	V
V_{IH}	HIGH-level input voltage on					
	pins SDA and SCL		[3] 0.7 $V_{DD(I2C)}$	-	$V_{DD(I2C)} + 0.5$	V
	pin XTALI		2.0	-	$V_{DD} + 0.3$	V
	pins for all other inputs		2.0	-	5.5	V
I_{LI}	input leakage current		-	-	1	μA
$I_{L/O}$	I/O leakage current		-	-	10	μA
C_i	input capacitance	outputs at 3-state	-	-	8	pF
$C_{i(n)}$	input capacitance all other inputs		-	-	5	pF
Digital outputs						
V_{OL}	LOW-level output voltage on					
	pins SDA and SCL	sink current at 3 mA	-	-	0.4	V
		sink current at 6 mA	-	-	0.6	V
	pin LLC		0	-	0.6	V
	pins for all other outputs	at $V_{DD(max)}$; $I_{OL} = 2\text{ mA}$	0	-	0.4	V
V_{OH}	HIGH-level output voltage on					
	pin LLC		2.4	-	$V_{DD} + 0.5$	V
	pins for all other outputs	at $V_{DD(min)}$; $I_{OH} = -2\text{ mA}$	2.4	-	$V_{DD} + 0.5$	V
DOT input timing (RTS1); see Figure 36						
$t_{SU,DAT}$	input data setup time		13	-	-	ns
$t_{HD,DAT}$	input data hold time		3	-	-	ns
Data and control output timing [4]						
C_L	output load capacitance		15	-	40	pF
$t_{OHD,DAT}$	output hold time	$C_L = 15\text{ pF}$	4	-	-	ns
t_{PD}	propagation delay	$C_L = 25\text{ pF}$	-	-	22	ns
t_{PDZ}	propagation delay to 3-state		-	-	22	ns
Clock output timing (LLC) [5]						
$C_{L(LLC)}$	output load capacitance		15	-	40	pF
T_{cy}	cycle time	LLC	35	-	39	ns
δ_{LLC}	duty factors for t_{LLCH}/t_{LLC}	$C_L = 25\text{ pF}$	40	-	60	%
t_r	rise time LLC		-	-	5	ns
t_f	fall time LLC		-	-	5	ns
Clock input timing (XTALI)						
δ_{XTALI}	duty factor for t_{XTALIH}/t_{XTALI}	nominal frequency	40	-	60	%

Table 78: Characteristics...continued

$V_{DD} = 3.0\text{ V to }3.6\text{ V}$; $V_{DDA} = 3.1\text{ V to }3.5\text{ V}$; $T_{amb} = 25\text{ }^\circ\text{C}$; unless otherwise specified.

Symbol	Parameter	Conditions	Min	Typ	Max	Unit
Horizontal PLL						
f_{Hn}	nominal line frequency	50 Hz field	-	15625	-	Hz
		60 Hz field	-	15734	-	Hz
$\Delta f_H/f_{Hn}$	permissible static deviation		-	-	5.7	%
Subcarrier PLL						
f_{SCn}	nominal subcarrier frequency	PAL BGHIN	-	4433619	-	Hz
		NTSC M; NTSC-Japan	-	3579545	-	Hz
		PAL M	-	3575612	-	Hz
		combination-PAL N	-	3582056	-	Hz
Δf_{SC}	lock-in range		± 400	-	-	Hz
Crystal oscillator						
f_n	nominal frequency	3rd harmonic	[6]	24.576	-	MHz
$\Delta f/f_n$	permissible nominal frequency deviation		-	-	$\pm 50 \times 10^{-6}$	-
$\Delta T f/f_{n(T)}$	permissible nominal frequency deviation with temperature		-	-	$\pm 20 \times 10^{-6}$	-
Crystal specification (X1)						
$T_{amb(X1)}$	operating ambient temperature		-40	-	+85	$^\circ\text{C}$
C_L	load capacitance		8	-	-	pF
R_s	series resonance resistor		-	40	80	Ω
C_1	motional capacitance		-	$1.5 \pm 20\%$	-	fF
C_0	parallel capacitance		-	$3.5 \pm 20\%$	-	pF

- [1] Minimum and maximum values are valid for $T_{amb} = -40\text{ }^\circ\text{C}$ to $+85\text{ }^\circ\text{C}$.
- [2] $V_{DD(I2C)}$ is the supply voltage of the I²C-bus. For $V_{DD(I2C)} = 3.3\text{ V}$ then $V_{IL(SCL,SDA)(max)} = 1\text{ V}$, for $V_{DD(I2C)} = 5\text{ V}$ then $V_{IL(SCL,SDA)(max)} = 1.5\text{ V}$.
- [3] $V_{DD(I2C)}$ is the supply voltage of the I²C-bus. For $V_{DD(I2C)} = 3.3\text{ V}$ then $V_{IH(SCL,SDA)(min)} = 2.3\text{ V}$, for $V_{DD(I2C)} = 5\text{ V}$ then $V_{IH(SCL,SDA)(min)} = 3.5\text{ V}$.
- [4] The levels must be measured with load circuits; $I_O = \pm 2\text{ mA}$; $C_L = 50\text{ pF}$. Timings and levels refer to drawings and conditions illustrated in [Figure 35](#) and [Figure 36](#).
- [5] The effects of rise and fall times are included in the calculation of $t_{OHD,DAT}$, t_{PD} and t_{PDZ} . Timings and levels refer to drawings and conditions illustrated in [Figure 35](#).
- [6] Order number: Philips 4322 143 05291.

Table 79: Processing delay

Function	Typical analog delay AI22 -> ADCIN (AOUT)	Digital delay ADCIN -> VPO (LLC CLOCKS); YDEL[2:0] = 0
Without amplifier or anti-alias filter	15 ns	157
With amplifier, without anti-alias filter	25 ns	
With amplifier and anti-alias filter	75 ns	

13. Timing diagrams

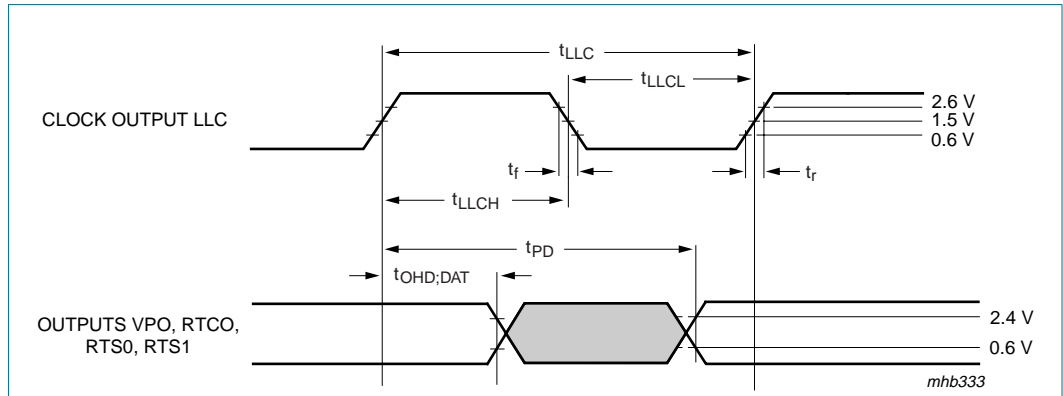

Fig 35. Clock and data output timing

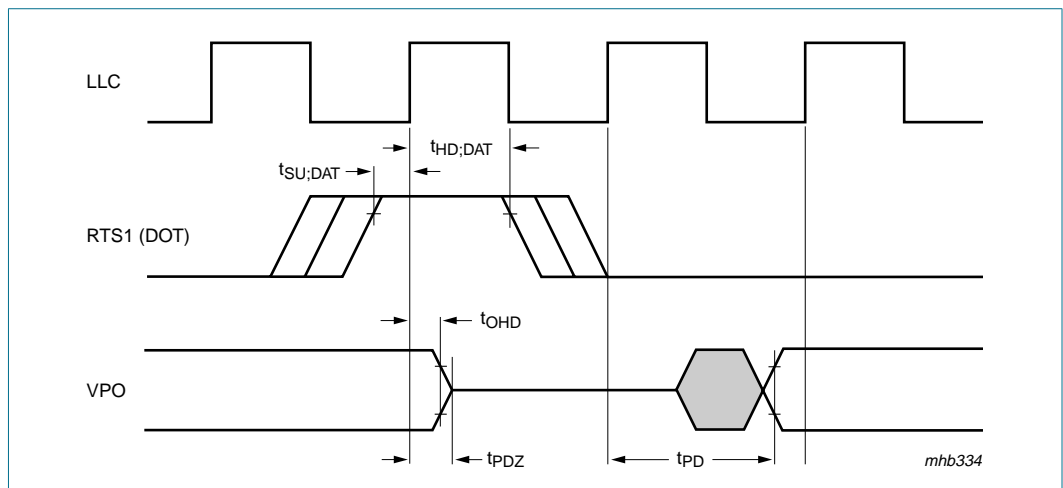
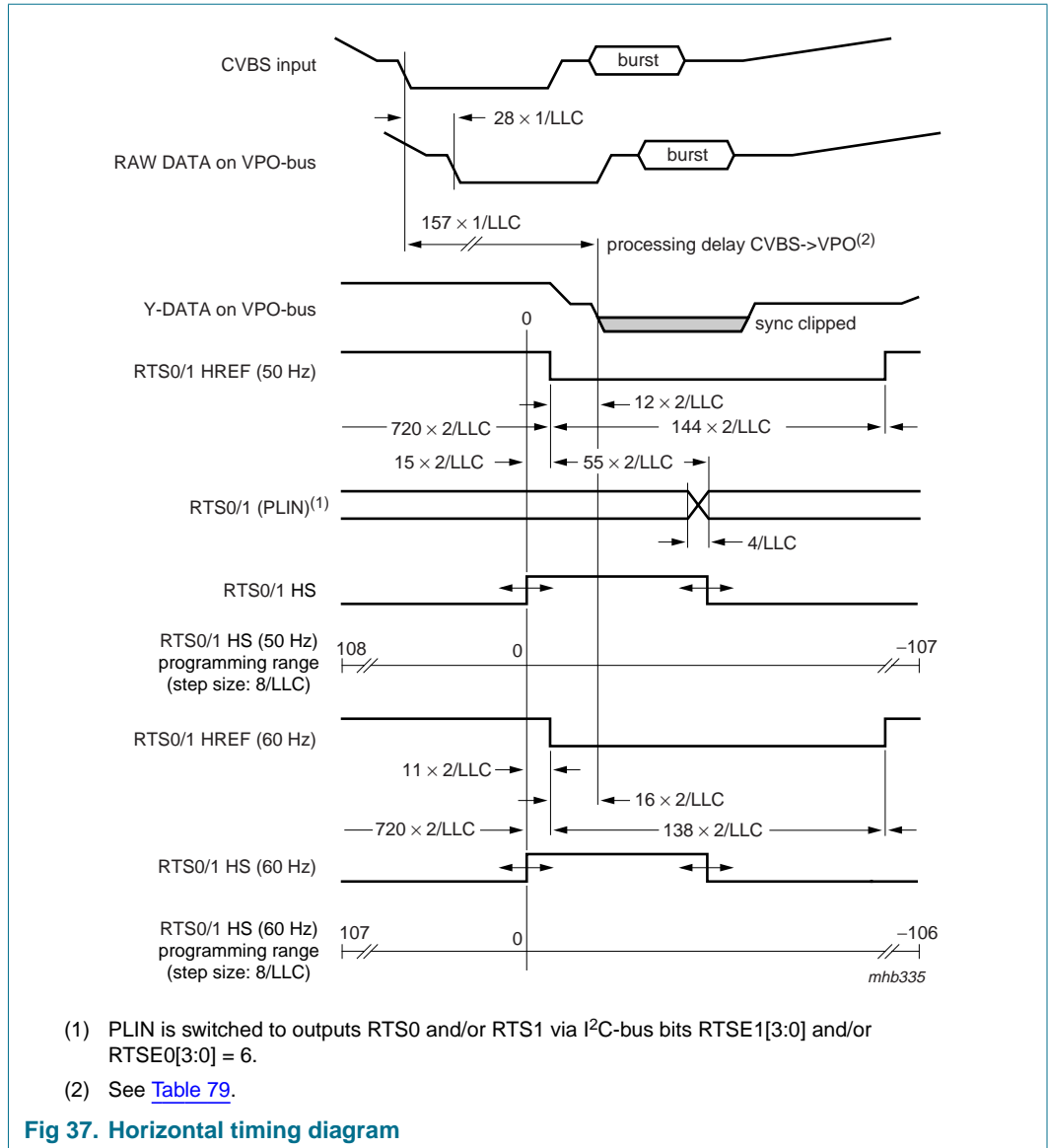
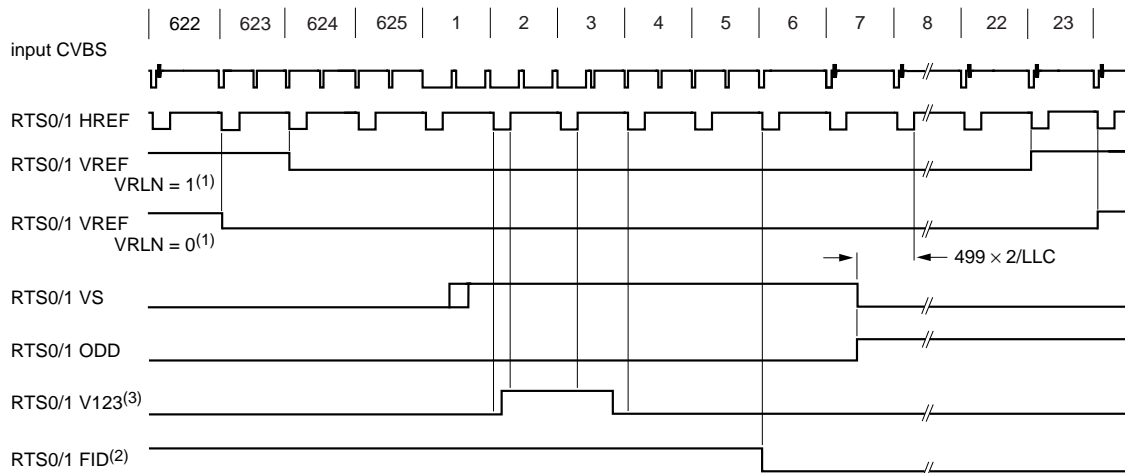
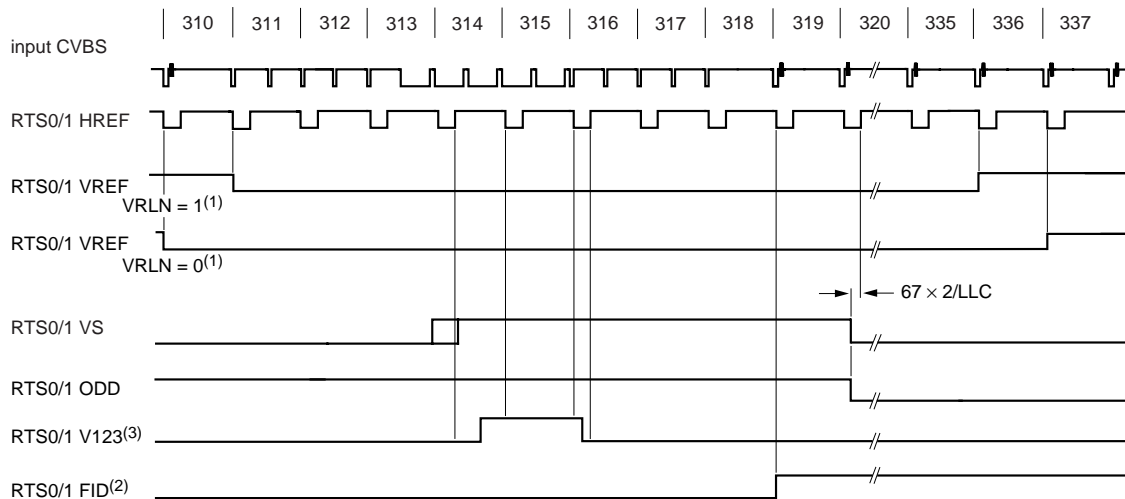

Fig 36. DOT input timing (RTS1)





(a) 1st field



(b) 2nd field

mhb336

HREF: selectable on RTS0 and/or RTS1 via I²C-bus bits RTSE03 to RTSE00 and/or RTSE13 to RTSE10 = 7h.

ODD: selectable on RTS0 and/or RTS1 via I²C-bus bits RTSE03 to RTSE00 and/or RTSE13 to RTSE10 = Ah.

VS: selectable on RTS0 and/or RTS1 via I²C-bus bits RTSE03 to RTSE00 and/or RTSE13 to RTSE10 = Bh.

V123: selectable on RTS0 and/or RTS1 via I²C-bus bits RTSE03 to RTSE00 and/or RTSE13 to RTSE10 = Ch.

VREF: selectable on RTS0 and/or RTS1 via I²C-bus bits RTSE03 to RTSE00 and/or RTSE13 to RTSE10 = Eh.

FID: selectable on RTS0 and/or RTS1 via I²C-bus bits RTSE03 to RTSE00 and/or RTSE13 to RTSE10 = Fh.

- (1) VREF range short or long can be programmed via I²C-bus bit VRLN. The luminance peaking and the chrominance trap are bypassed during VREF = 0 if I²C-bus bit VBLB is set to logic 1. The chrominance delay line (chrominance-comb filter for NTSC, phase error correcting for PAL) is disabled during VREF = 0.
- (2) FID changing line number and polarity programmable via VSTA8 to VSTA0 and FIDP (see [Table 53](#)).
- (3) The inactive going edge of the V123-signal indicates whether the field is odd or even. If HREF is active during the falling edge of V123, the field is **odd**. If HREF is inactive during the falling edge of V123, the field is **even**. The specific position of the slope is dependent on the internal processing delay and may change a few clock cycles from version to version.

Fig 38. Vertical timing diagram for 50 Hz [nominal input signal, VNL in normal mode (VNOI = 00), HPLL in VCR or fast mode (HTC = 01 or 11)]

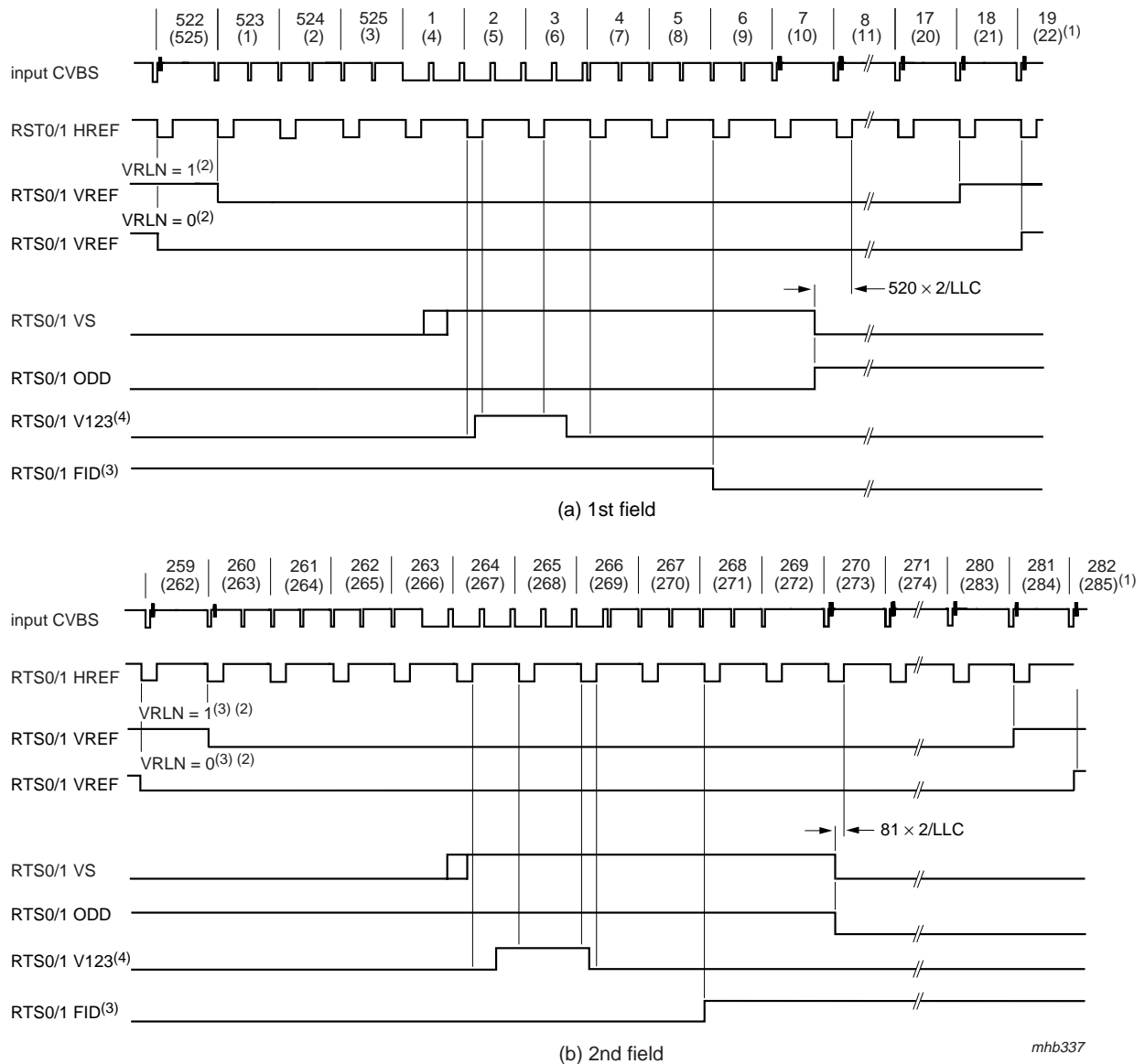

HREF: selectable on RTS0 and/or RTS1 via I²C-bus bits RTSE03 to RTSE00 and/or RTSE13 to RTSE10 = 7h.
 ODD: selectable on RTS0 and/or RTS1 via I²C-bus bits RTSE03 to RTSE00 and/or RTSE13 to RTSE10 = Ah.
 VS: selectable on RTS0 and/or RTS1 via I²C-bus bits RTSE03 to RTSE00 and/or RTSE13 to RTSE10 = Bh.
 V123: selectable on RTS0 and/or RTS1 via I²C-bus bits RTSE03 to RTSE00 and/or RTSE13 to RTSE10 = Ch.
 VREF: selectable on RTS0 and/or RTS1 via I²C-bus bits RTSE03 to RTSE00 and/or RTSE13 to RTSE10 = Eh.
 FID: selectable on RTS0 and/or RTS1 via I²C-bus bits RTSE03 to RTSE00 and/or RTSE13 to RTSE10 = Fh.

- (1) Line numbers in parenthesis refer to ITU line counting.
- (2) VREF range short or long can be programmed via I²C-bus bit VRLN. The luminance peaking and the chrominance trap are bypassed during VREF = 0 if I²C-bus bit VBLB is set to logic 1. The chrominance delay line (chrominance-comb filter for NTSC, phase error correcting for PAL) is disabled during VREF = 0.
- (3) FID changing line number and polarity programmable via VSTA8 to VSTA0 and FIDP (see Table 53).
- (4) The inactive going edge of the V123-signal indicates whether the field is odd or even. If HREF is active during the falling edge of V123, the field is **odd**. If HREF is inactive during the falling edge of V123, the field is **even**. The specific position of the slope is dependent on the internal processing delay and may change a few clock cycles from version to version.

Fig 39. Vertical timing diagram for 60 Hz [nominal input signal, VNL in normal mode (VNOI = 00), HPLL in VCR or fast mode (HTC = 01 or 11)]

14. Errata information

14.1 Fast H-lock indicator bit

- Issue: The H-lock indicator bit (HL_FAST, available on RTS0/RTS1 and selectable with HLSEL via I²C-bus) shows a static behavior which doesn't match the specified function.
- Impact: It is not possible to use the signal HL_FAST as fast horizontal locking indicator bit for quick source switching. This anomaly has minor impact for most video applications since this feature will be used mainly for security applications.
- Work-around: Use of the normal flag HL or HLCK instead of HL_FAST.

14.2 Fast time constant HPLL

- Issue: The damping factor of the digital horizontal PLL is too high.
- Impact: It is not possible to use the new fast time constant with VCR sources due to visible run-ins on the first lines.
- Work-around: The old VCR time constant should be used.

14.3 Fast locking mode

- Issue: The fast vertical locking mode VNL shows an undefined behavior which doesn't match the specified function.
- Impact: It is not possible to use the fast vertical locking mode VNL since in some unknown circumstances the fast locking mode needs more time for locking than the normal mode. This anomaly has minor impact for most video applications since this feature will be used mainly for security applications.
- Work-around: No recommendations for a functional replacement of this feature.

14.4 Odd/even detection might become unreliable with signals from video tape recorders

The odd/even detection is a flag, available on a pin, to indicate the interlace of a video signal; this should be independent of the type of input signal.

- Issue: If a signal originated from a VTR suffers from phase errors greater than 16 μ s, the odd/even detection might be set onto a wrong phase, thus interrupting the actual odd-even sequence of the input signal.
- Impact: If the generated odd/even flag is being used in a succeeding signal processing, this processing could eventually be upset due to incorrect detection.
- Work-around: It should be avoided to use the detected odd/even information whenever it cannot be assured that the input signal is of stable time base.

14.5 Indifferent detection of copy protected signals

Detection of copy protected signals according to the Macrovision scheme (pseudo sync and AGC pulses) and thus the contents of the status information COPRO (I²C-bus status bit, D1 of subaddress 1Fh) should be independent of the signal source.

- Issue: The detection of copy protected signals is not always stable with deteriorated VCR signal sources or with certain VCRs or camcorders, especially with spurious pulses that will be interpreted as pseudo syncs.
- Impact: The internal detection circuitry might react too sensitive in a sense that a copy protected signal is being detected that actually is not copy protected.
- Work-around: Sometimes it will be advantageous to average the COPRO status information (under control of the system microcontroller) for about one minute.

15. Application information

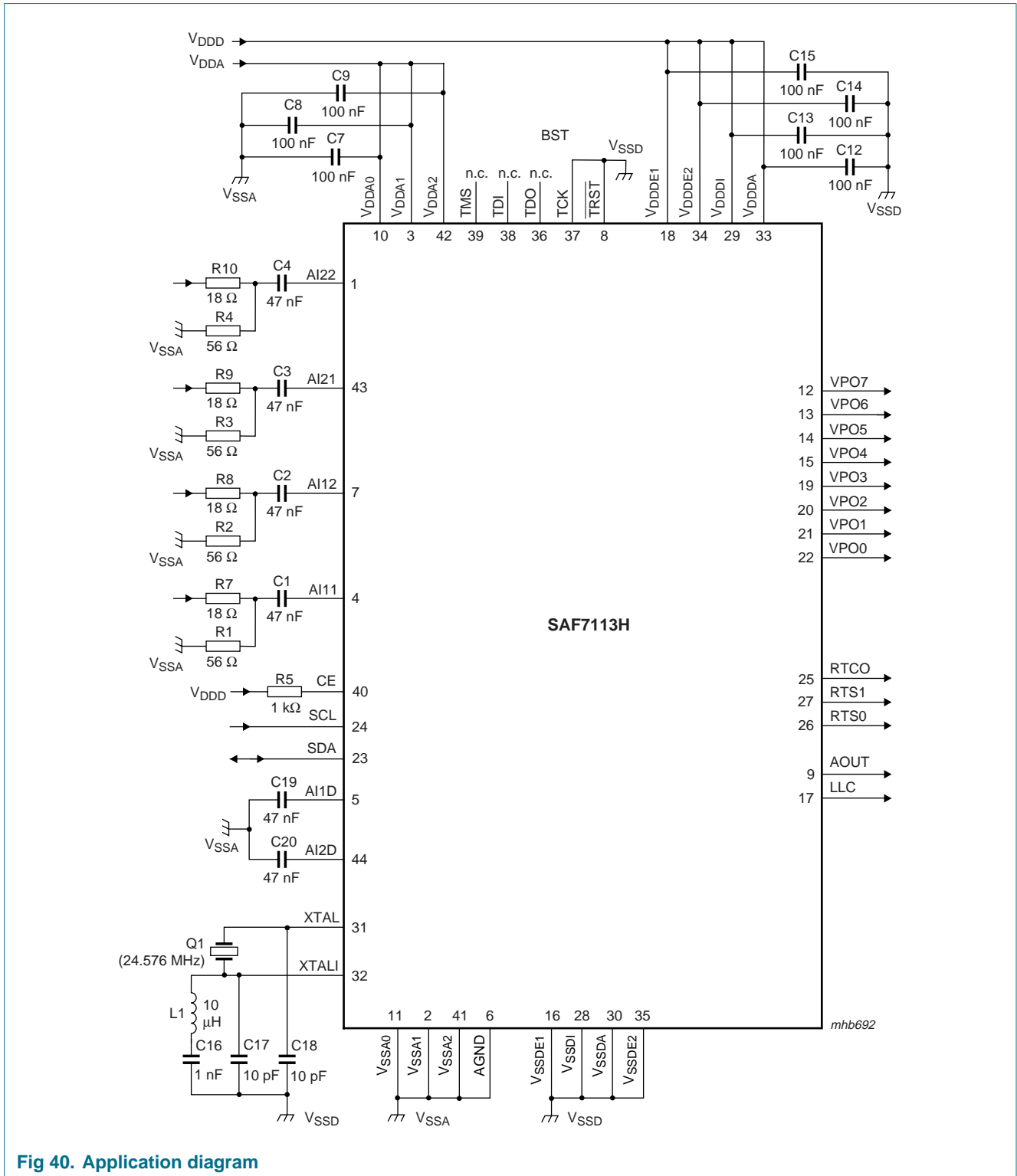
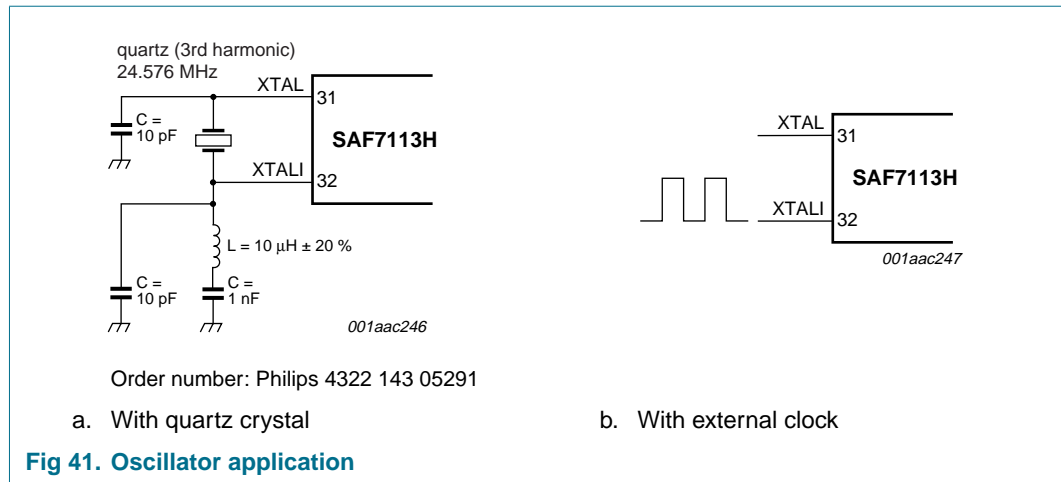

Fig 40. Application diagram



16. Test information

16.1 Boundary scan test

The SAF7113H has built-in logic and five dedicated pins to support boundary scan testing which allows board testing without special hardware (nails). The SAF7113H follows the “*IEEE Std. 1149.1 - Standard Test Access Port and Boundary-Scan Architecture*” set by the Joint Test Action Group (JTAG) chaired by Philips.

The 5 special pins are Test Mode Select (TMS), Test Clock (TCK), Test Reset ($\overline{\text{TRST}}$), Test Data Input (TDI) and Test Data Output (TDO).

The Boundary Scan Test (BST) functions BYPASS, EXTEST, INTEST, SAMPLE, CLAMP and IDCODE are all supported (see [Table 80](#)). Details about the JTAG BST-test can be found in the specification “*IEEE Std. 1149.1*”. A file containing the detailed Boundary Scan Description Language (BSDL) of the SAF7113H is available on request.

Table 80: BST instructions supported by the SAF7113H

Instruction	Description
BYPASS	This mandatory instruction provides a minimum length serial path (1 bit) between pins TDI and TDO when no test operation of the component is required.
EXTEST	This mandatory instruction allows testing of off-chip circuitry and board level interconnections.
SAMPLE	This mandatory instruction can be used to take a sample of the inputs during normal operation of the component. It can also be used to preload data values into the latched outputs of the boundary scan register.
CLAMP	This optional instruction is useful for testing when not all ICs have BST. This instruction addresses the bypass register while the boundary scan register is in external test mode.
IDCODE	This optional instruction will provide information on the components manufacturer, part number and version number.
INTEST	This optional instruction allows testing of the internal logic (no support for customers available).
USER1	This private instruction allows testing by the manufacturer (no support for customers available).

16.1.1 Initialization of boundary scan circuit

The Test Access Port (TAP) controller of an IC should be in the reset state (TEST_LOGIC_RESET) when the IC is in the functional mode. This reset state also forces the instruction register into a functional instruction such as IDCODE or BYPASS.

To solve the power-up reset, the standard specifies that the TAP controller will be forced asynchronously to the TEST_LOGIC_RESET state by setting the $\overline{\text{TRST}}$ pin LOW.

16.1.2 Device identification codes

A device identification register is specified in "IEEE Std. 1149.1b-1994". It is a 32-bit register which contains fields for the specification of the IC manufacturer, the IC part number and the IC version number. Its biggest advantage is the possibility to check for the correct ICs mounted after production and determination of the version number of ICs during field service.

When the IDCODE instruction is loaded into the BST instruction register, the identification register will be connected between pins TDI and TDO of the IC. The identification register will load a component specific code during the CAPTURE_DATA_REGISTER state of the TAP controller and this code can subsequently be shifted out. At board level, this code can be used to verify component manufacturer, type and version number. The device identification register contains 32 bits, numbered 31 to 0, where bit 31 is the most significant bit (nearest to TDI) and bit 0 is the least significant bit (nearest to TDO) (see [Figure 42](#)).

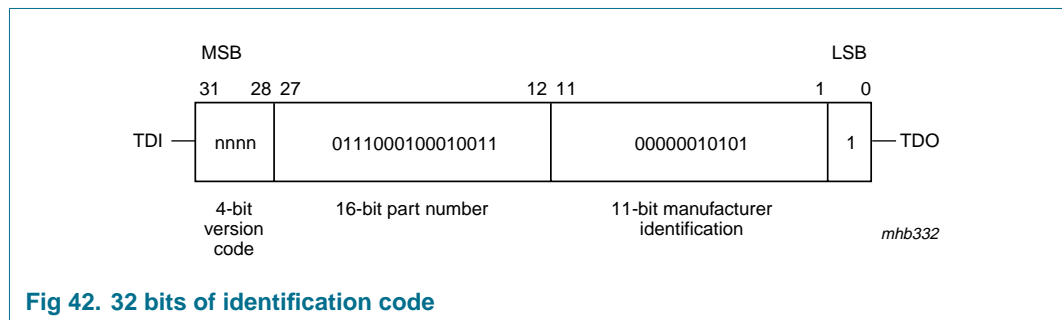

17. Package outline

QFP44: plastic quad flat package; 44 leads (lead length 1.3 mm); body 10 x 10 x 1.75 mm

SOT307-2

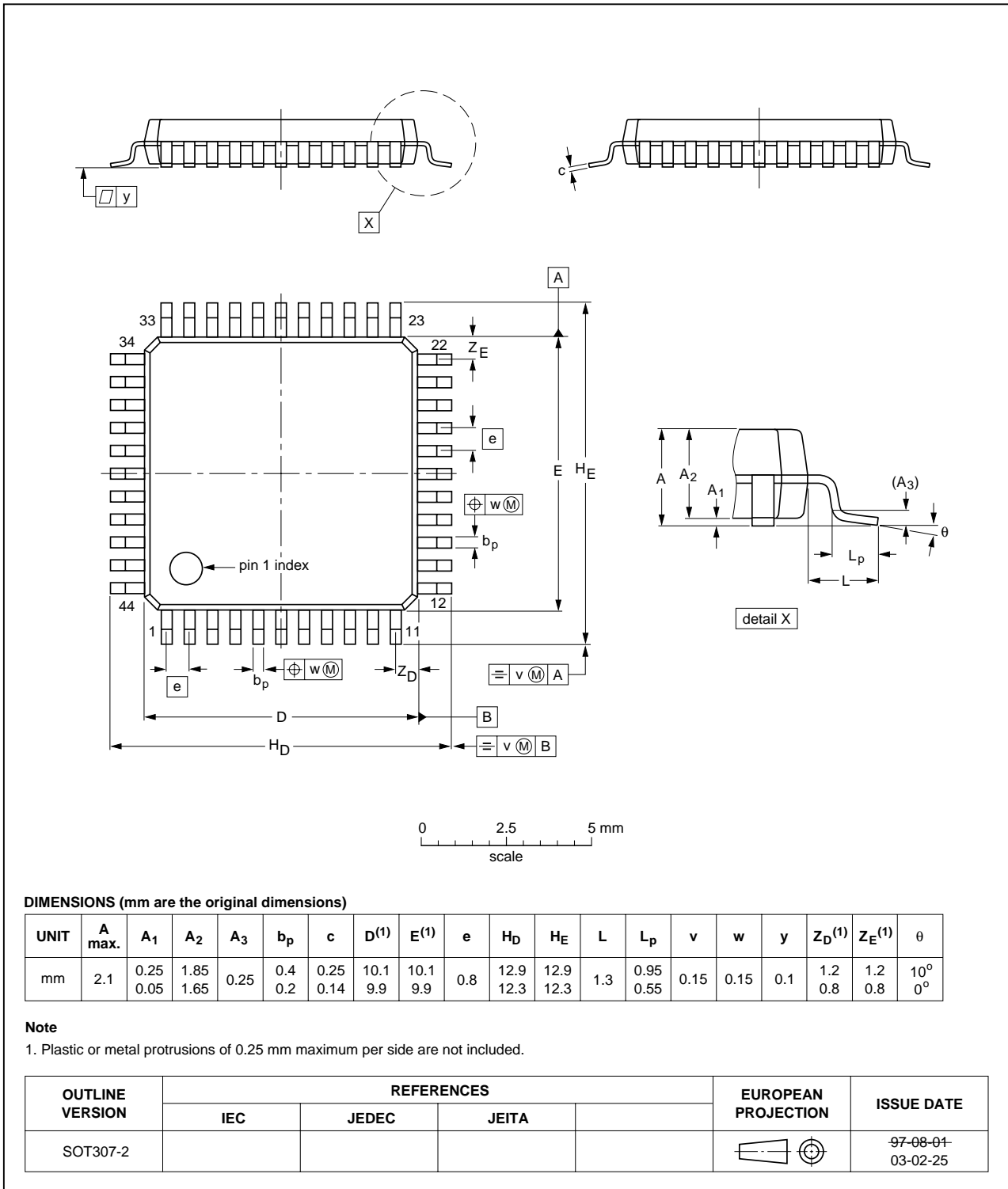

Fig 43. Package outline SOT307-2 (QFP44)

18. Soldering

18.1 Introduction to soldering surface mount packages

This text gives a very brief insight to a complex technology. A more in-depth account of soldering ICs can be found in our *Data Handbook IC26; Integrated Circuit Packages* (document order number 9398 652 90011).

There is no soldering method that is ideal for all surface mount IC packages. Wave soldering can still be used for certain surface mount ICs, but it is not suitable for fine pitch SMDs. In these situations reflow soldering is recommended.

18.2 Reflow soldering

Reflow soldering requires solder paste (a suspension of fine solder particles, flux and binding agent) to be applied to the printed-circuit board by screen printing, stencilling or pressure-syringe dispensing before package placement. Driven by legislation and environmental forces the worldwide use of lead-free solder pastes is increasing.

Several methods exist for reflowing; for example, convection or convection/infrared heating in a conveyor type oven. Throughput times (preheating, soldering and cooling) vary between 100 seconds and 200 seconds depending on heating method.

Typical reflow peak temperatures range from 215 °C to 270 °C depending on solder paste material. The top-surface temperature of the packages should preferably be kept:

- below 225 °C (SnPb process) or below 245 °C (Pb-free process)
 - for all BGA, HTSSON..T and SSOP..T packages
 - for packages with a thickness ≥ 2.5 mm
 - for packages with a thickness < 2.5 mm and a volume ≥ 350 mm³ so called thick/large packages.
- below 240 °C (SnPb process) or below 260 °C (Pb-free process) for packages with a thickness < 2.5 mm and a volume < 350 mm³ so called small/thin packages.

Moisture sensitivity precautions, as indicated on packing, must be respected at all times.

18.3 Wave soldering

Conventional single wave soldering is not recommended for surface mount devices (SMDs) or printed-circuit boards with a high component density, as solder bridging and non-wetting can present major problems.

To overcome these problems the double-wave soldering method was specifically developed.

If wave soldering is used the following conditions must be observed for optimal results:

- Use a double-wave soldering method comprising a turbulent wave with high upward pressure followed by a smooth laminar wave.
- For packages with leads on two sides and a pitch (e):
 - larger than or equal to 1.27 mm, the footprint longitudinal axis is **preferred** to be parallel to the transport direction of the printed-circuit board;

- smaller than 1.27 mm, the footprint longitudinal axis **must** be parallel to the transport direction of the printed-circuit board.

The footprint must incorporate solder thieves at the downstream end.

- For packages with leads on four sides, the footprint must be placed at a 45° angle to the transport direction of the printed-circuit board. The footprint must incorporate solder thieves downstream and at the side corners.

During placement and before soldering, the package must be fixed with a droplet of adhesive. The adhesive can be applied by screen printing, pin transfer or syringe dispensing. The package can be soldered after the adhesive is cured.

Typical dwell time of the leads in the wave ranges from 3 seconds to 4 seconds at 250 °C or 265 °C, depending on solder material applied, SnPb or Pb-free respectively.

A mildly-activated flux will eliminate the need for removal of corrosive residues in most applications.

18.4 Manual soldering

Fix the component by first soldering two diagonally-opposite end leads. Use a low voltage (24 V or less) soldering iron applied to the flat part of the lead. Contact time must be limited to 10 seconds at up to 300 °C.

When using a dedicated tool, all other leads can be soldered in one operation within 2 seconds to 5 seconds between 270 °C and 320 °C.

18.5 Package related soldering information

Table 81: Suitability of surface mount IC packages for wave and reflow soldering methods

Package [1]	Soldering method	
	Wave	Reflow [2]
BGA, HTSSON..T [3], LBGA, LFBGA, SQFP, SSOP..T [3], TFBGA, VFBGA, XSON	not suitable	suitable
DHVQFN, HBCC, HBGA, HLQFP, HSO, HSOP, HSQFP, HSSON, HTQFP, HTSSOP, HVQFN, HVSON, SMS	not suitable [4]	suitable
PLCC [5], SO, SOJ	suitable	suitable
LQFP, QFP, TQFP	not recommended [5] [6]	suitable
SSOP, TSSOP, VSO, VSSOP	not recommended [7]	suitable
CWQCCN..L [8], PMFP [9], WQCCN..L [8]	not suitable	not suitable

[1] For more detailed information on the BGA packages refer to the *(LF)BGA Application Note (AN01026)*; order a copy from your Philips Semiconductors sales office.

[2] All surface mount (SMD) packages are moisture sensitive. Depending upon the moisture content, the maximum temperature (with respect to time) and body size of the package, there is a risk that internal or external package cracks may occur due to vaporization of the moisture in them (the so called popcorn effect). For details, refer to the Drypack information in the *Data Handbook IC26; Integrated Circuit Packages; Section: Packing Methods*.

[3] These transparent plastic packages are extremely sensitive to reflow soldering conditions and must on no account be processed through more than one soldering cycle or subjected to infrared reflow soldering with peak temperature exceeding 217 °C ± 10 °C measured in the atmosphere of the reflow oven. The package body peak temperature must be kept as low as possible.

- [4] These packages are not suitable for wave soldering. On versions with the heatsink on the bottom side, the solder cannot penetrate between the printed-circuit board and the heatsink. On versions with the heatsink on the top side, the solder might be deposited on the heatsink surface.
- [5] If wave soldering is considered, then the package must be placed at a 45° angle to the solder wave direction. The package footprint must incorporate solder thieves downstream and at the side corners.
- [6] Wave soldering is suitable for LQFP, QFP and TQFP packages with a pitch (e) larger than 0.8 mm; it is definitely not suitable for packages with a pitch (e) equal to or smaller than 0.65 mm.
- [7] Wave soldering is suitable for SSOP, TSSOP, VSO and VSSOP packages with a pitch (e) equal to or larger than 0.65 mm; it is definitely not suitable for packages with a pitch (e) equal to or smaller than 0.5 mm.
- [8] Image sensor packages in principle should not be soldered. They are mounted in sockets or delivered pre-mounted on flex foil. However, the image sensor package can be mounted by the client on a flex foil by using a hot bar soldering process. The appropriate soldering profile can be provided on request.
- [9] Hot bar soldering or manual soldering is suitable for PMFP packages.

19. Revision history

Table 82: Revision history

Document ID	Release date	Data sheet status	Change notice	Doc. number	Supersedes
SAF7113H_3	20050509	Product data sheet	-	9397 750 14231	SAF7113H_2
Modifications:	<ul style="list-style-type: none"> • The format of this data sheet has been redesigned to comply with the new presentation and information standard of Philips Semiconductors. • Table 3: Changed description of pins 23 and 24. • Table 78: Digital inputs, input leakage current: changed maximum value from 10 µA to 1 µA. • Table 78: Digital inputs, I/O leakage current: added maximum value of 10 µA. 				
SAF7113H_2	20040322	Product specification	-	9397 750 12902	SAF7113H_1
SAF7113H_1	20000508	Product specification	-	9397 750 06968	-

20. Data sheet status

Level	Data sheet status ^[1]	Product status ^{[2] [3]}	Definition
I	Objective data	Development	This data sheet contains data from the objective specification for product development. Philips Semiconductors reserves the right to change the specification in any manner without notice.
II	Preliminary data	Qualification	This data sheet contains data from the preliminary specification. Supplementary data will be published at a later date. Philips Semiconductors reserves the right to change the specification without notice, in order to improve the design and supply the best possible product.
III	Product data	Production	This data sheet contains data from the product specification. Philips Semiconductors reserves the right to make changes at any time in order to improve the design, manufacturing and supply. Relevant changes will be communicated via a Customer Product/Process Change Notification (CPCN).

[1] Please consult the most recently issued data sheet before initiating or completing a design.

[2] The product status of the device(s) described in this data sheet may have changed since this data sheet was published. The latest information is available on the Internet at URL <http://www.semiconductors.philips.com>.

[3] For data sheets describing multiple type numbers, the highest-level product status determines the data sheet status.

21. Definitions

Short-form specification — The data in a short-form specification is extracted from a full data sheet with the same type number and title. For detailed information see the relevant data sheet or data handbook.

Limiting values definition — Limiting values given are in accordance with the Absolute Maximum Rating System (IEC 60134). Stress above one or more of the limiting values may cause permanent damage to the device. These are stress ratings only and operation of the device at these or at any other conditions above those given in the Characteristics sections of the specification is not implied. Exposure to limiting values for extended periods may affect device reliability.

Application information — Applications that are described herein for any of these products are for illustrative purposes only. Philips Semiconductors make no representation or warranty that such applications will be suitable for the specified use without further testing or modification.

22. Disclaimers

Life support — These products are not designed for use in life support appliances, devices, or systems where malfunction of these products can reasonably be expected to result in personal injury. Philips Semiconductors

24. Contact information

For additional information, please visit: <http://www.semiconductors.philips.com>

For sales office addresses, send an email to: sales.addresses@www.semiconductors.philips.com

customers using or selling these products for use in such applications do so at their own risk and agree to fully indemnify Philips Semiconductors for any damages resulting from such application.

Right to make changes — Philips Semiconductors reserves the right to make changes in the products - including circuits, standard cells, and/or software - described or contained herein in order to improve design and/or performance. When the product is in full production (status 'Production'), relevant changes will be communicated via a Customer Product/Process Change Notification (CPCN). Philips Semiconductors assumes no responsibility or liability for the use of any of these products, conveys no license or title under any patent, copyright, or mask work right to these products, and makes no representations or warranties that these products are free from patent, copyright, or mask work right infringement, unless otherwise specified.

23. Trademarks

Notice — All referenced brands, product names, service names and trademarks are the property of their respective owners.

25. Contents

1	General description	1	9.2.20	Subaddress 13h	49
2	Features	1	9.2.21	Subaddress 15h	49
3	Applications	2	9.2.22	Subaddress 16h	50
4	Quick reference data	3	9.2.23	Subaddress 17h	50
5	Ordering information	3	9.2.24	Subaddress 1Fh (read only register)	50
6	Block diagram	4	9.2.25	Subaddress 40h	51
7	Pinning information	5	9.2.26	Subaddresses 41h to 57h	52
7.1	Pinning	5	9.2.27	Subaddress 58h	52
7.2	Pin description	5	9.2.28	Subaddress 59h	53
8	Functional description	7	9.2.29	Subaddress 5Ah	53
8.1	Analog input processing	7	9.2.30	Subaddress 5Bh	53
8.2	Analog control circuits	7	9.2.31	Subaddress 5Eh	53
8.2.1	Clamping	8	9.2.32	Subaddress 60h (read only register)	53
8.2.2	Gain control	8	9.2.33	Subaddress 61h (read only register)	54
8.3	Chrominance processing	11	9.2.34	Subaddress 62h (read only register)	54
8.4	Luminance processing	15	9.3	I ² C-bus start setup	54
8.5	Synchronization	20	10	Limiting values	56
8.6	Clock generation circuit	21	11	Thermal characteristics	57
8.7	Power-on reset and CE input	22	12	Characteristics	57
8.8	Multistandard VBI data slicer	23	13	Timing diagrams	60
8.9	VBI-raw data bypass	24	14	Errata information	64
8.10	Digital output port VPO7 to VPO0	24	14.1	Fast H-lock indicator bit	64
8.11	RTCO output	32	14.2	Fast time constant HPLL	64
8.12	RTS0 and RTS1 terminals	32	14.3	Fast locking mode	64
9	I²C-bus description	33	14.4	Odd/even detection might become unreliable with signals from video tape recorders	64
9.1	I ² C-bus format	33	14.5	Indifferent detection of copy protected signals	65
9.2	I ² C-bus register description	34	15	Application information	66
9.2.1	Subaddress 00h (read only register)	37	16	Test information	67
9.2.2	Subaddress 01h	37	16.1	Boundary scan test	67
9.2.3	Subaddress 02h	37	16.1.1	Initialization of boundary scan circuit	68
9.2.4	Subaddress 03h	39	16.1.2	Device identification codes	68
9.2.5	Subaddress 04h	39	17	Package outline	69
9.2.6	Subaddress 05h	40	18	Soldering	70
9.2.7	Subaddress 06h	40	18.1	Introduction to soldering surface mount packages	70
9.2.8	Subaddress 07h	40	18.2	Reflow soldering	70
9.2.9	Subaddress 08h	41	18.3	Wave soldering	70
9.2.10	Subaddress 09h	41	18.4	Manual soldering	71
9.2.11	Subaddress 0Ah	42	18.5	Package related soldering information	71
9.2.12	Subaddress 0Bh	43	19	Revision history	72
9.2.13	Subaddress 0Ch	43	20	Data sheet status	73
9.2.14	Subaddress 0Dh	43	21	Definitions	73
9.2.15	Subaddress 0Eh	43	22	Disclaimers	73
9.2.16	Subaddress 0Fh	44	23	Trademarks	73
9.2.17	Subaddress 10h	45			
9.2.18	Subaddress 11h	46			
9.2.19	Subaddress 12h	46			

continued >>



24 **Contact information** 73



© Koninklijke Philips Electronics N.V. 2005

All rights are reserved. Reproduction in whole or in part is prohibited without the prior written consent of the copyright owner. The information presented in this document does not form part of any quotation or contract, is believed to be accurate and reliable and may be changed without notice. No liability will be accepted by the publisher for any consequence of its use. Publication thereof does not convey nor imply any license under patent- or other industrial or intellectual property rights.

Date of release: 9 May 2005
Document number: 9397 750 14231

Published in The Netherlands