

BFR92AW

NPN 5 GHz wideband transistor

Rev. 03 — 12 March 2008

Product data sheet

IMPORTANT NOTICE

Dear customer,

As from October 1st, 2006 Philips Semiconductors has a new trade name - NXP Semiconductors, which will be used in future data sheets together with new contact details.

In data sheets where the previous Philips references remain, please use the new links as shown below.

<http://www.philips.semiconductors.com> use <http://www.nxp.com>

<http://www.semiconductors.philips.com> use <http://www.nxp.com> (Internet)

sales.addresses@www.semiconductors.philips.com use salesaddresses@nxp.com (email)

The copyright notice at the bottom of each page (or elsewhere in the document, depending on the version)

- © Koninklijke Philips Electronics N.V. (year). All rights reserved -

is replaced with:

- © NXP B.V. (year). All rights reserved. -

If you have any questions related to the data sheet, please contact our nearest sales office via e-mail or phone (details via salesaddresses@nxp.com). Thank you for your cooperation and understanding,

NXP Semiconductors

NPN 5 GHz wideband transistor

BFR92AW

FEATURES

- High power gain
- Gold metallization ensures excellent reliability
- SOT323 (S-mini) package.

APPLICATIONS

It is designed for use in RF amplifiers, mixers and oscillators with signal frequencies up to 1 GHz.

DESCRIPTION

Silicon NPN transistor encapsulated in a plastic SOT323 (S-mini) package. The BFR92AW uses the same crystal as the SOT23 version, BFR92A.

PINNING

PIN	DESCRIPTION
1	base
2	emitter
3	collector

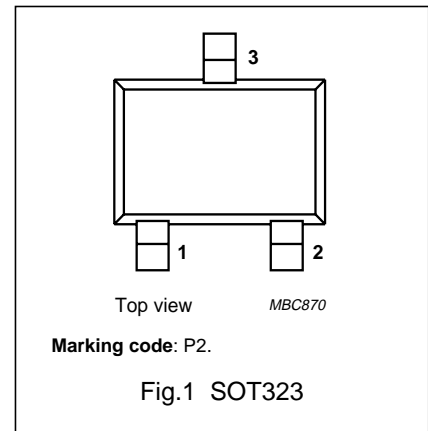

QUICK REFERENCE DATA

SYMBOL	PARAMETER	CONDITIONS	MIN.	TYP.	MAX.	UNIT
V_{CBO}	collector-base voltage	open emitter	–	–	20	V
V_{CEO}	collector-emitter voltage	open base	–	–	15	V
I_C	collector current (DC)		–	–	25	mA
P_{tot}	total power dissipation	up to $T_s = 93\text{ °C}$; note 1	–	–	300	mW
h_{FE}	current gain	$I_C = 15\text{ mA}$; $V_{CE} = 10\text{ V}$	65	90	135	
C_{re}	feedback capacitance	$I_C = 0$; $V_{CE} = 10\text{ V}$; $f = 1\text{ MHz}$; $T_{amb} = 25\text{ °C}$	–	0.35	–	pF
f_T	transition frequency	$I_C = 15\text{ mA}$; $V_{CE} = 10\text{ V}$; $f = 500\text{ MHz}$	3.5	5	–	GHz
G_{UM}	maximum unilateral power gain	$I_C = 15\text{ mA}$; $V_{CE} = 10\text{ V}$; $f = 1\text{ GHz}$; $T_{amb} = 25\text{ °C}$	–	14	–	dB
		$I_C = 15\text{ mA}$; $V_{CE} = 10\text{ V}$; $f = 2\text{ GHz}$; $T_{amb} = 25\text{ °C}$	–	8	–	dB
F	noise figure	$I_C = 5\text{ mA}$; $V_{CE} = 10\text{ V}$; $f = 1\text{ GHz}$; $\Gamma_s = \Gamma_{opt}$	–	2	–	dB
T_j	junction temperature		–	–	150	°C

Note

1. T_s is the temperature at the soldering point of the collector pin.

NPN 5 GHz wideband transistor

BFR92AW

LIMITING VALUES

In accordance with the Absolute Maximum System (IEC 134).

SYMBOL	PARAMETER	CONDITIONS	MIN.	MAX.	UNIT
V _{CBO}	collector-base voltage	open emitter	–	20	V
V _{CEO}	collector-emitter voltage	open base	–	15	V
V _{EBO}	emitter-base voltage	open collector	–	2	V
I _C	collector current (DC)		–	25	mA
P _{tot}	total power dissipation	up to T _s = 93 °C; see Fig.2; note 1	–	300	mW
T _{stg}	storage temperature		–65	+150	°C
T _j	junction temperature		–	150	°C

THERMAL CHARACTERISTICS

SYMBOL	PARAMETER	CONDITIONS	VALUE	UNIT
R _{th j-s}	thermal resistance from junction to soldering point	up to T _s = 93 °C; note 1	190	K/W

Note to the Limiting values and Thermal characteristics

1. T_s is the temperature at the soldering point of the collector pin.

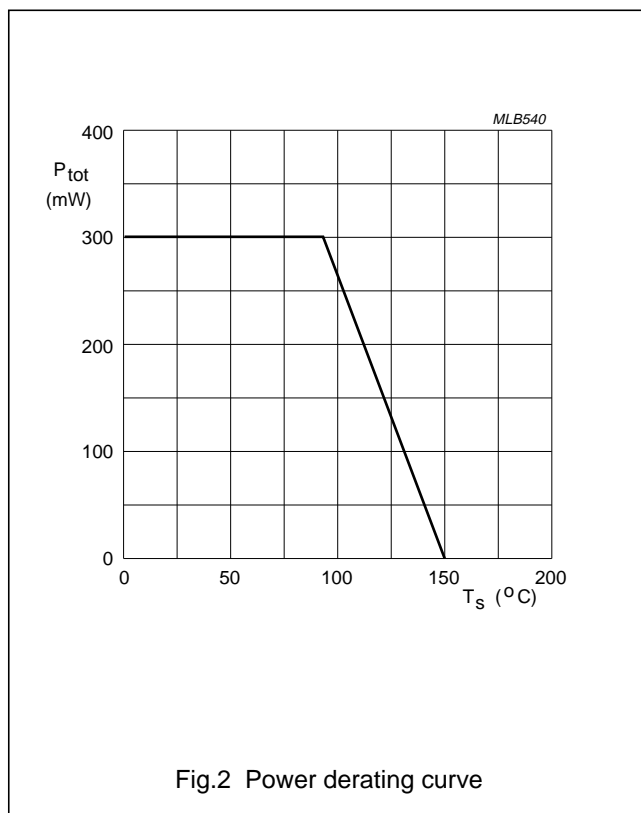

NPN 5 GHz wideband transistor

BFR92AW

CHARACTERISTICS

$T_j = 25\text{ °C}$ (unless otherwise specified).

SYMBOL	PARAMETER	CONDITIONS	MIN.	TYP.	MAX.	UNIT
I_{CBO}	collector leakage current	$I_E = 0; V_{CB} = 10\text{ V}$	–	–	50	nA
h_{FE}	DC current gain	$I_C = 15\text{ mA}; V_{CE} = 10\text{ V}$	65	90	135	
C_c	collector capacitance	$I_E = i_e = 0; V_{CB} = 10\text{ V}; f = 1\text{ MHz}$	–	0.6	–	pF
C_e	emitter capacitance	$I_C = i_c = 0; V_{EB} = 0.5\text{ V}; f = 1\text{ MHz}$	–	0.9	–	pF
C_{re}	feedback capacitance	$I_C = 0; V_{CE} = 10\text{ V}; f = 1\text{ MHz}$	–	0.35	–	pF
f_T	transition frequency	$I_C = 15\text{ mA}; V_{CE} = 10\text{ V}; f = 500\text{ MHz}$	3.5	5	–	GHz
G_{UM}	maximum unilateral power gain; note 1	$I_C = 15\text{ mA}; V_{CE} = 10\text{ V};$ $f = 1\text{ GHz}; T_{amb} = 25\text{ °C}$	–	14	–	dB
		$I_C = 15\text{ mA}; V_{CE} = 10\text{ V};$ $f = 2\text{ GHz}; T_{amb} = 25\text{ °C}$	–	8	–	dB
F	noise figure	$I_C = 5\text{ mA}; V_{CE} = 10\text{ V};$ $f = 1\text{ GHz}; \Gamma_s = \Gamma_{opt}$	–	2	–	dB
		$I_C = 5\text{ mA}; V_{CE} = 10\text{ V};$ $f = 2\text{ GHz}; \Gamma_s = \Gamma_{opt}$	–	3	–	dB

Note

1. G_{UM} is the maximum unilateral power gain, assuming s_{12} is zero and $G_{UM} = 10 \log \frac{|s_{21}|^2}{(1 - |s_{11}|^2)(1 - |s_{22}|^2)}$ dB.

NPN 5 GHz wideband transistor

BFR92AW

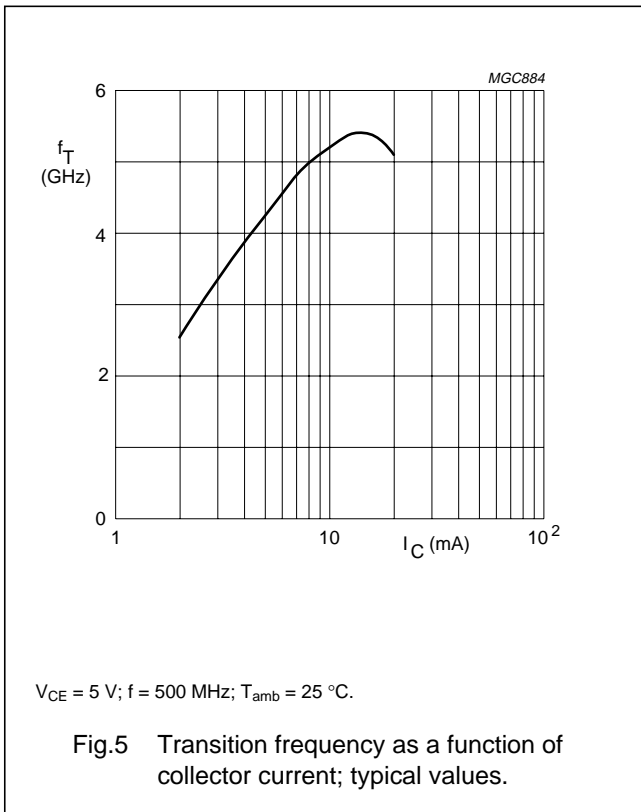
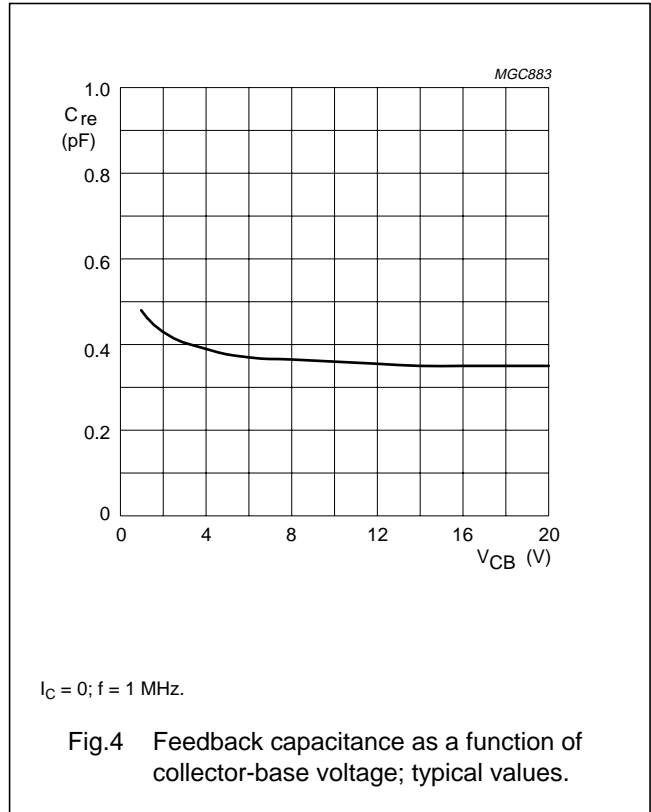
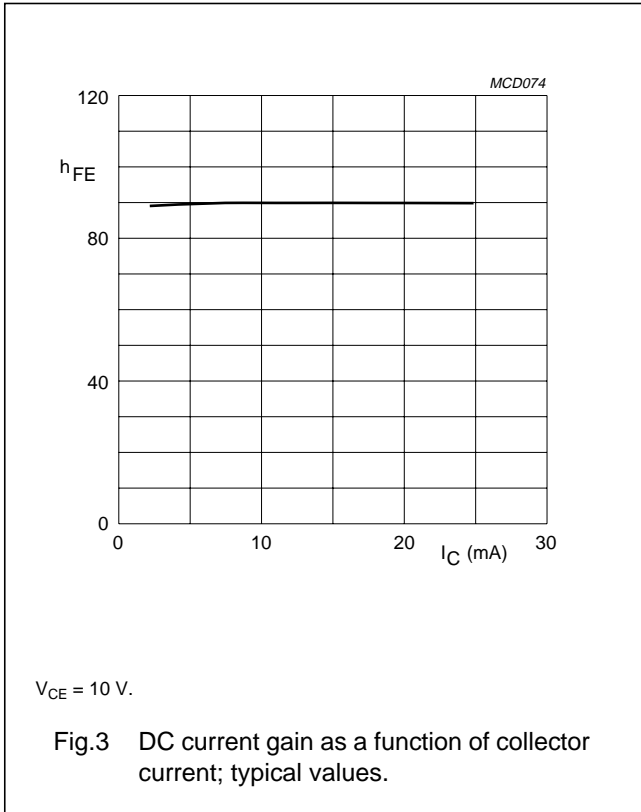

NPN 5 GHz wideband transistor

BFR92AW

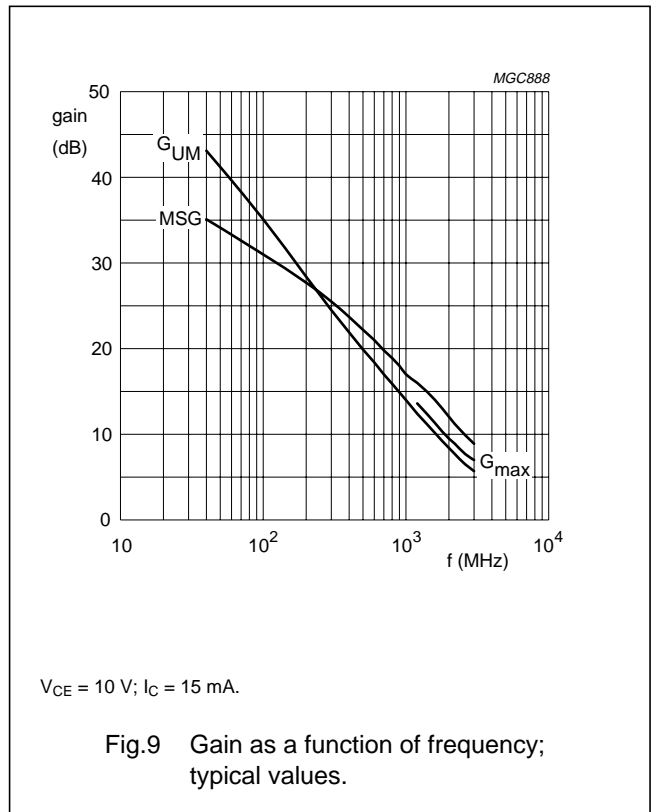
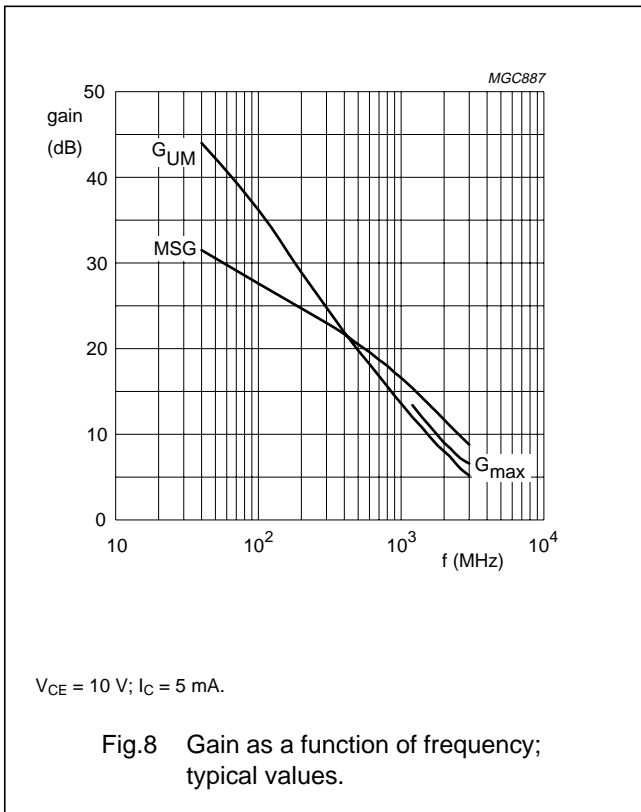
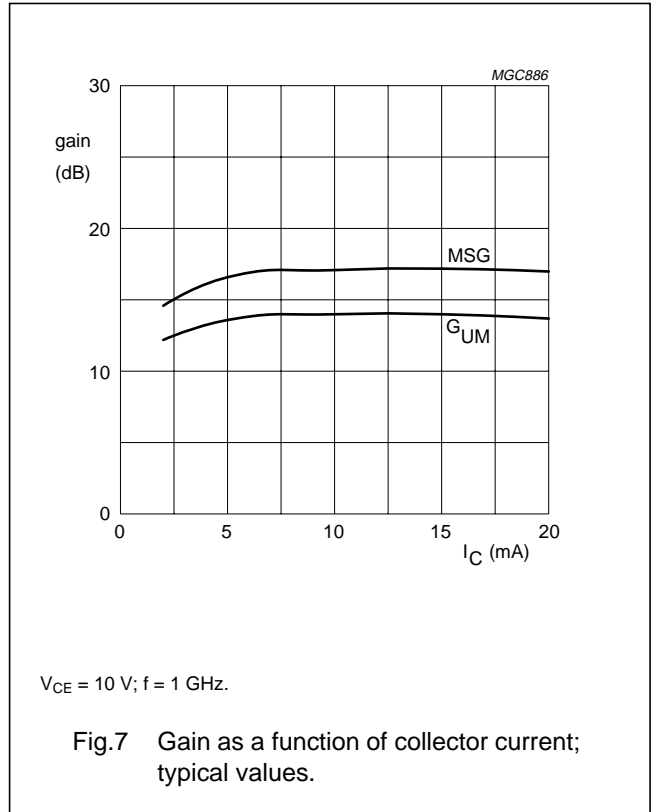
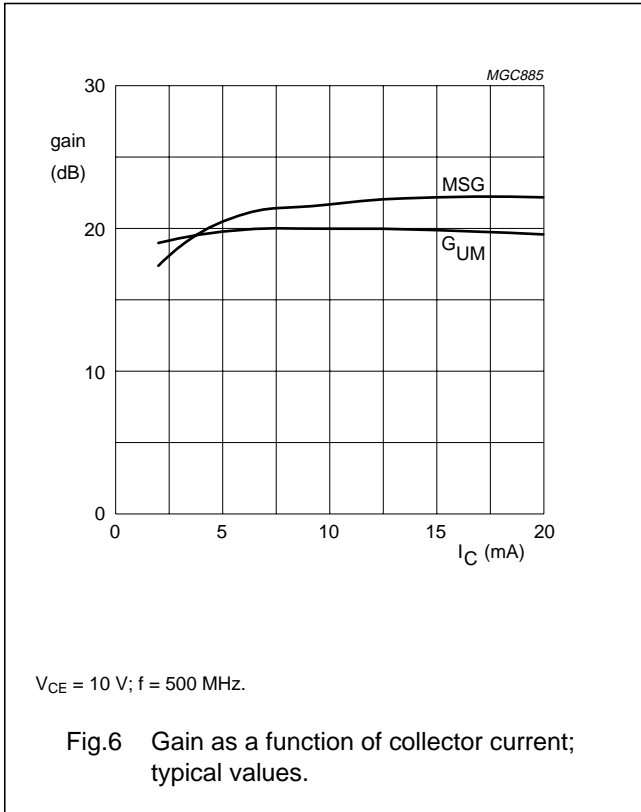

NPN 5 GHz wideband transistor

BFR92AW

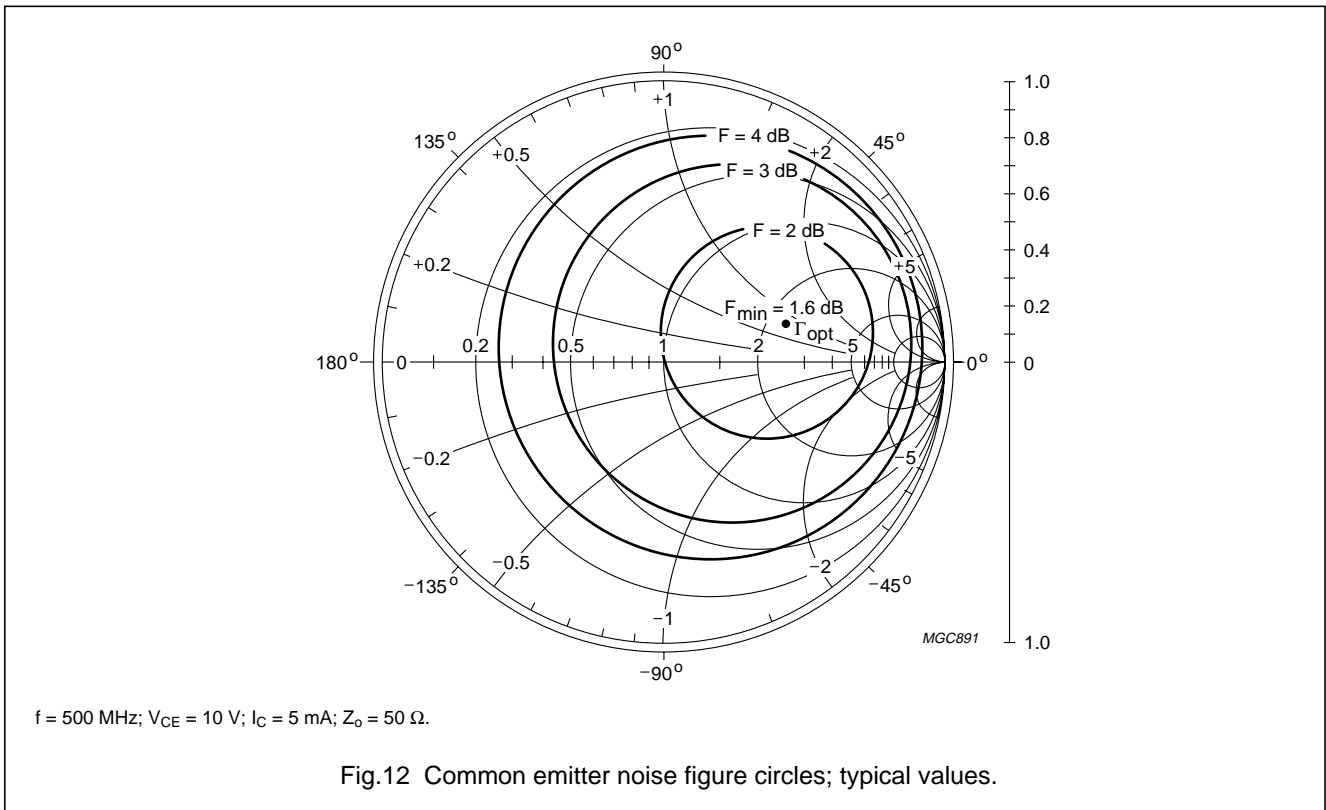
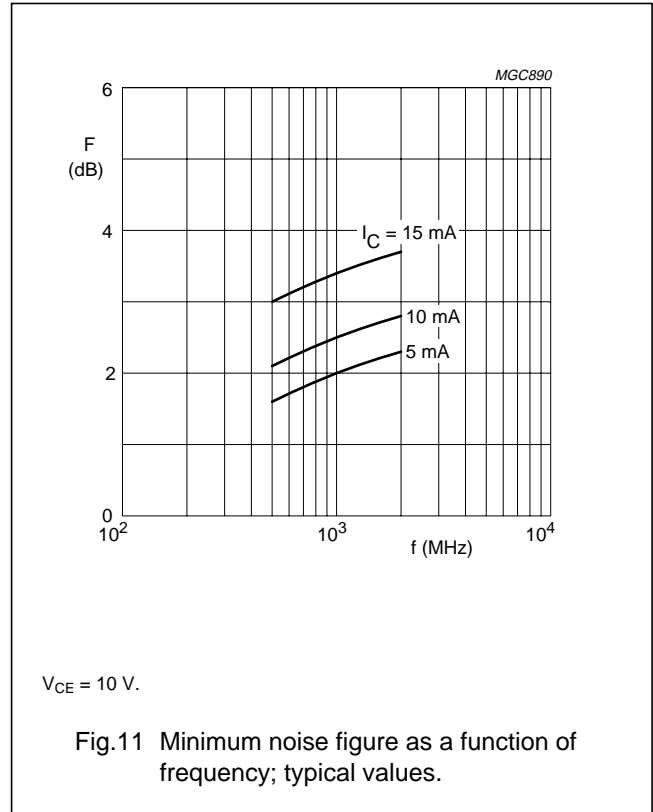
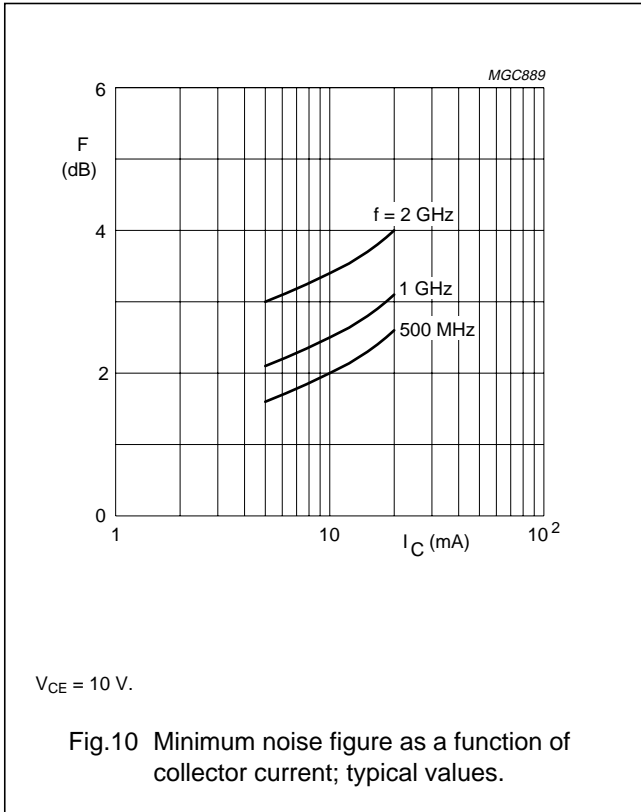

NPN 5 GHz wideband transistor

BFR92AW

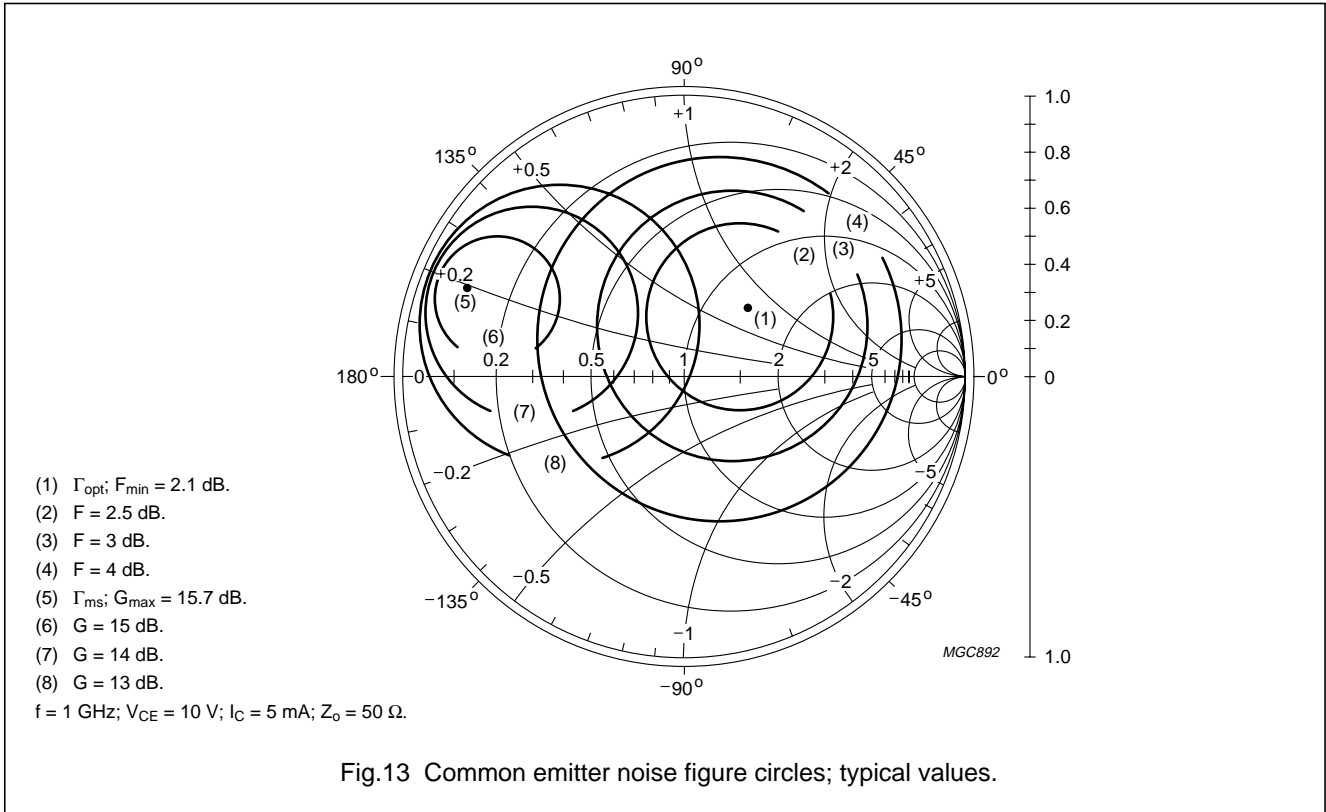

Fig.13 Common emitter noise figure circles; typical values.

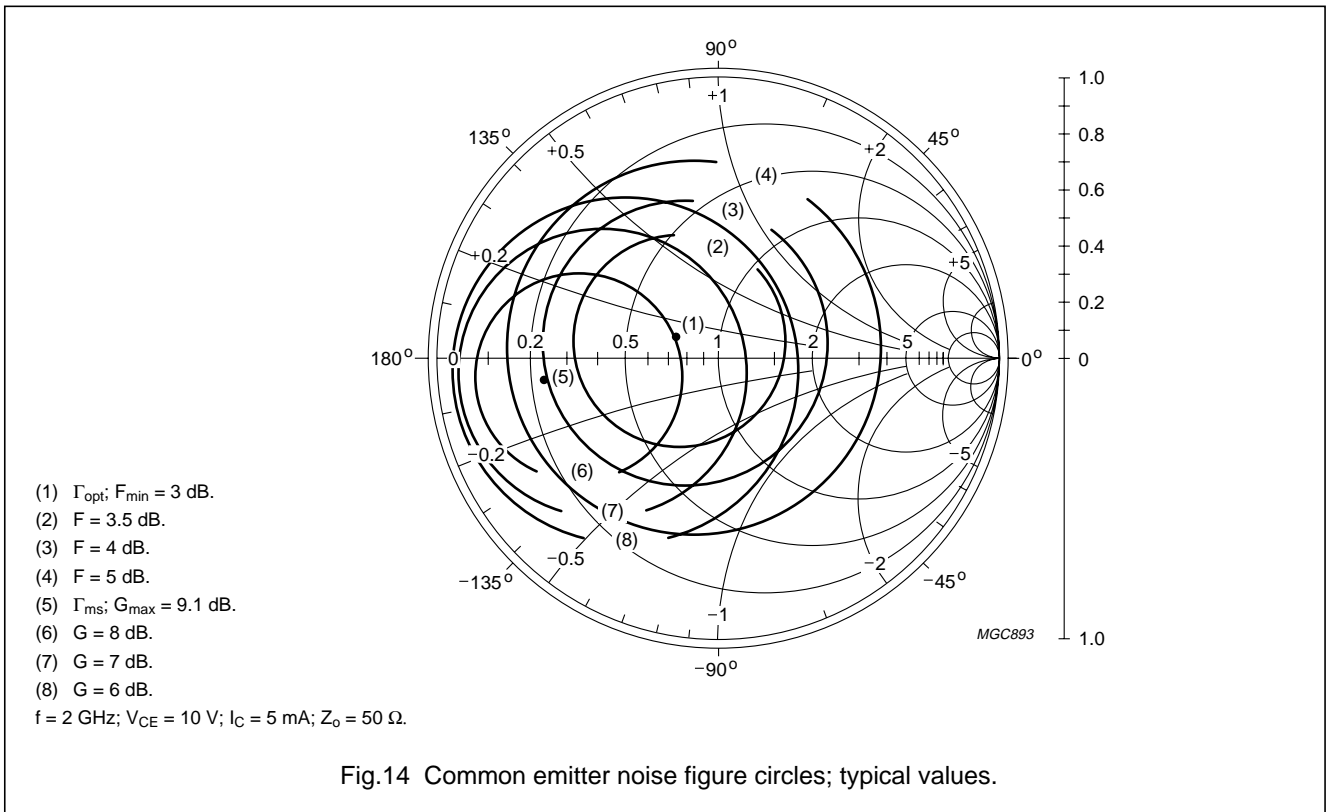
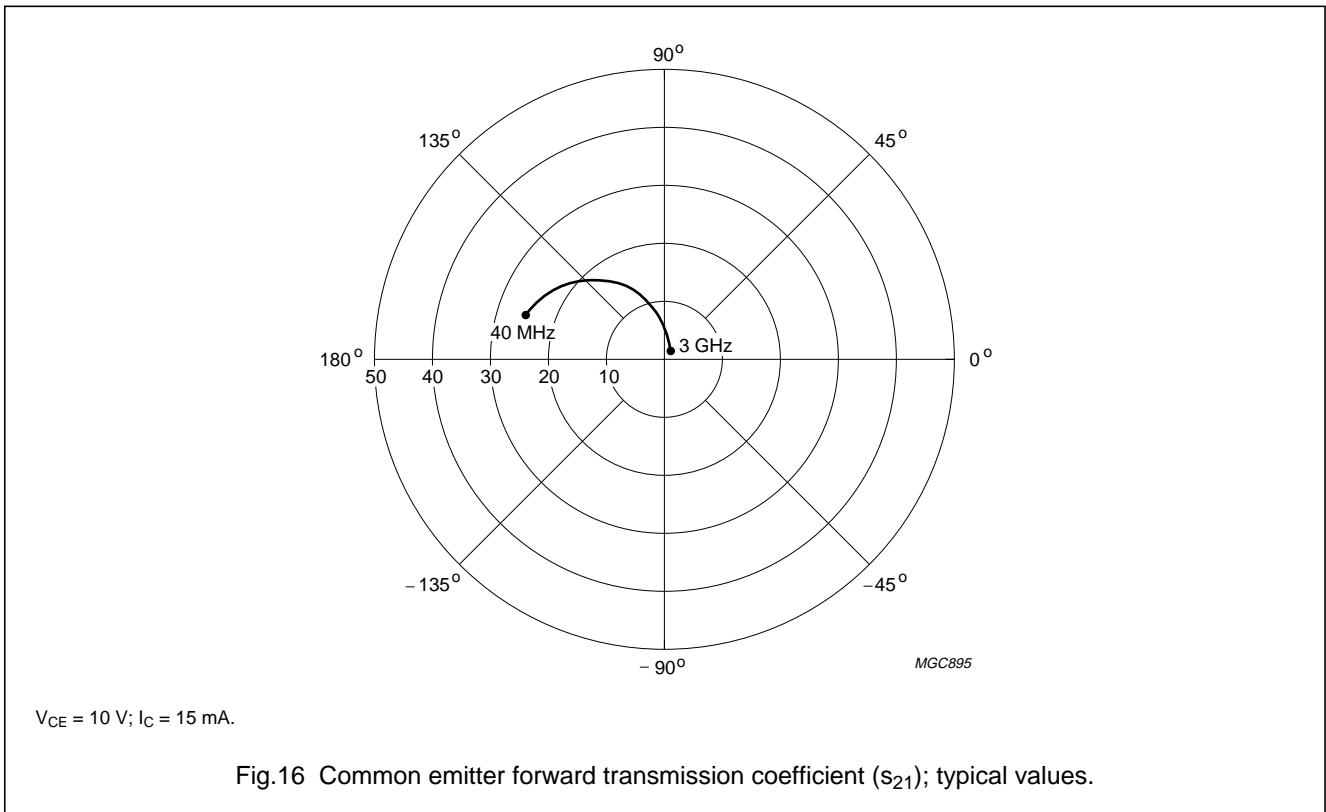
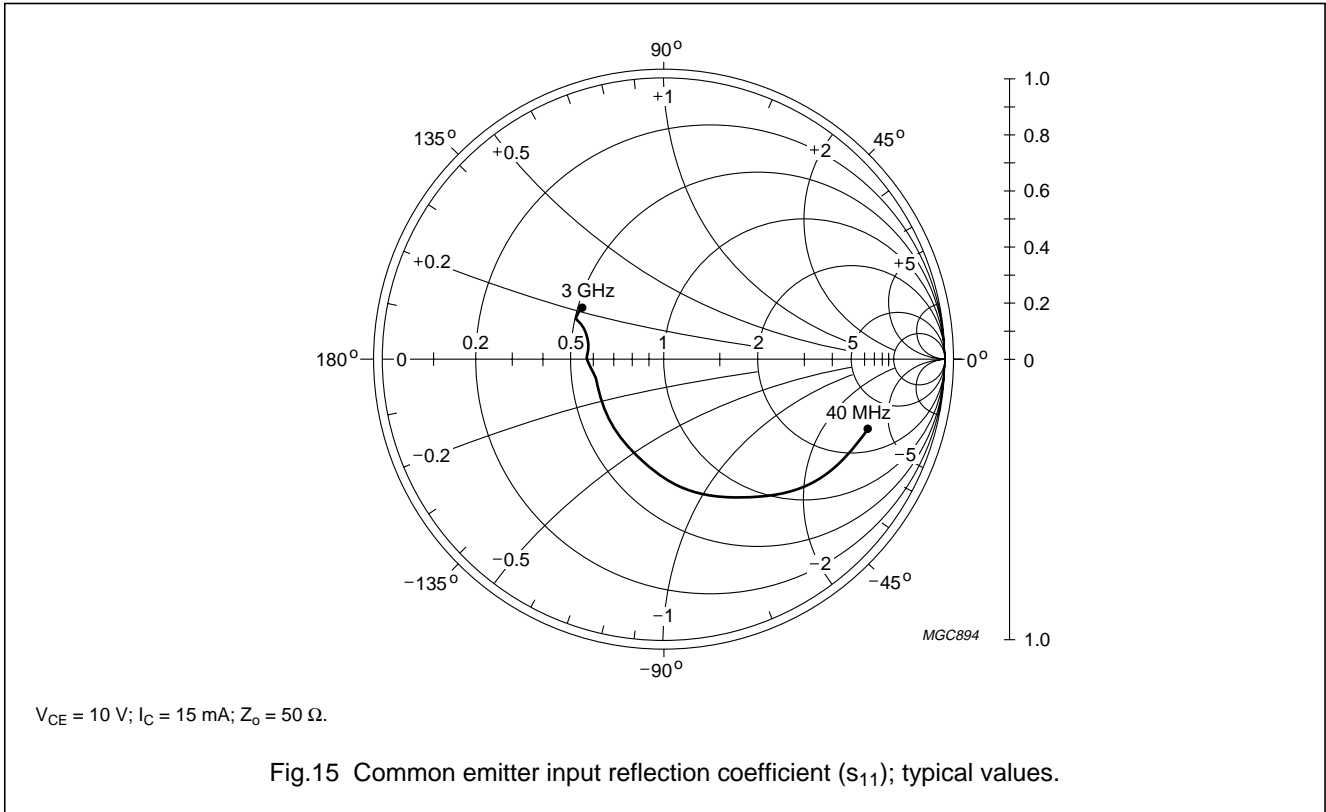

Fig.14 Common emitter noise figure circles; typical values.

NPN 5 GHz wideband transistor

BFR92AW



NPN 5 GHz wideband transistor

BFR92AW

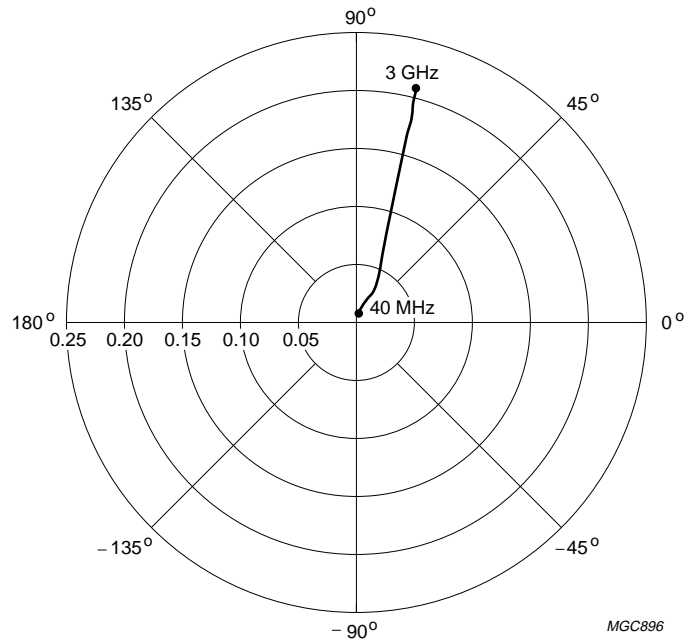

$V_{CE} = 10\text{ V}; I_C = 15\text{ mA}$.

Fig.17 Common emitter reverse transmission coefficient (s_{12}); typical values.

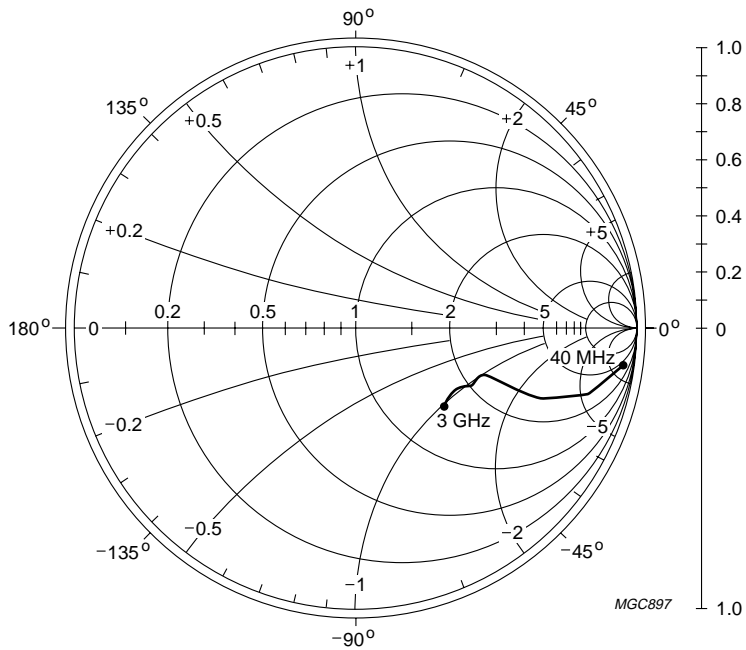

$V_{CE} = 10\text{ V}; I_C = 15\text{ mA}; Z_o = 50\ \Omega$.

Fig.18 Common emitter output reflection coefficient (s_{22}); typical values.

Legal information

Data sheet status

Document status ^{[1][2]}	Product status ^[3]	Definition
Objective [short] data sheet	Development	This document contains data from the objective specification for product development.
Preliminary [short] data sheet	Qualification	This document contains data from the preliminary specification.
Product [short] data sheet	Production	This document contains the product specification.

[1] Please consult the most recently issued document before initiating or completing a design.

[2] The term 'short data sheet' is explained in section "Definitions".

[3] The product status of device(s) described in this document may have changed since this document was published and may differ in case of multiple devices. The latest product status information is available on the Internet at URL <http://www.nxp.com>.

Definitions

Draft — The document is a draft version only. The content is still under internal review and subject to formal approval, which may result in modifications or additions. NXP Semiconductors does not give any representations or warranties as to the accuracy or completeness of information included herein and shall have no liability for the consequences of use of such information.

Short data sheet — A short data sheet is an extract from a full data sheet with the same product type number(s) and title. A short data sheet is intended for quick reference only and should not be relied upon to contain detailed and full information. For detailed and full information see the relevant full data sheet, which is available on request via the local NXP Semiconductors sales office. In case of any inconsistency or conflict with the short data sheet, the full data sheet shall prevail.

Disclaimers

General — Information in this document is believed to be accurate and reliable. However, NXP Semiconductors does not give any representations or warranties, expressed or implied, as to the accuracy or completeness of such information and shall have no liability for the consequences of use of such information.

Right to make changes — NXP Semiconductors reserves the right to make changes to information published in this document, including without limitation specifications and product descriptions, at any time and without notice. This document supersedes and replaces all information supplied prior to the publication hereof.

Suitability for use — NXP Semiconductors products are not designed, authorized or warranted to be suitable for use in medical, military, aircraft, space or life support equipment, nor in applications where failure or malfunction of an NXP Semiconductors product can reasonably be expected to result in personal injury, death or severe property or environmental

damage. NXP Semiconductors accepts no liability for inclusion and/or use of NXP Semiconductors products in such equipment or applications and therefore such inclusion and/or use is at the customer's own risk.

Applications — Applications that are described herein for any of these products are for illustrative purposes only. NXP Semiconductors makes no representation or warranty that such applications will be suitable for the specified use without further testing or modification.

Limiting values — Stress above one or more limiting values (as defined in the Absolute Maximum Ratings System of IEC 60134) may cause permanent damage to the device. Limiting values are stress ratings only and operation of the device at these or any other conditions above those given in the Characteristics sections of this document is not implied. Exposure to limiting values for extended periods may affect device reliability.

Terms and conditions of sale — NXP Semiconductors products are sold subject to the general terms and conditions of commercial sale, as published at <http://www.nxp.com/profile/terms>, including those pertaining to warranty, intellectual property rights infringement and limitation of liability, unless explicitly otherwise agreed to in writing by NXP Semiconductors. In case of any inconsistency or conflict between information in this document and such terms and conditions, the latter will prevail.

No offer to sell or license — Nothing in this document may be interpreted or construed as an offer to sell products that is open for acceptance or the grant, conveyance or implication of any license under any copyrights, patents or other industrial or intellectual property rights.

Quick reference data — The Quick reference data is an extract of the product data given in the Limiting values and Characteristics sections of this document, and as such is not complete, exhaustive or legally binding.

Trademarks

Notice: All referenced brands, product names, service names and trademarks are the property of their respective owners.

Contact information

For more information, please visit: <http://www.nxp.com>

For sales office addresses, please send an email to: salesaddresses@nxp.com

Revision history

Revision history

Document ID	Release date	Data sheet status	Change notice	Supersedes
BFR92AW_N_3	20080312	Product data sheet	-	BFR92AW_2
Modifications:	• Quick reference data and Characteristics Table; DC current gain value changed			
BFR92AW_2	19950918	Product specification	-	BFR92AW_1
BFR92AW_1	19921001	-	-	-

Please be aware that important notices concerning this document and the product(s) described herein, have been included in section 'Legal information'.

founded by

PHILIPS

© NXP B.V. 2008.

All rights reserved.

For more information, please visit: <http://www.nxp.com>

For sales office addresses, please send an email to: salesaddresses@nxp.com

Date of release: 12 March 2008

Document identifier: BFR92AW_N_3