

# DATA SHEET

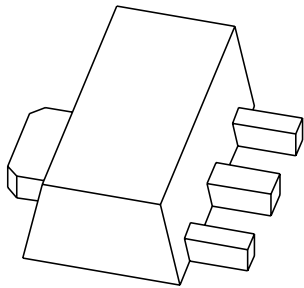

**PBSS4350X**

**50 V, 3 A**

**NPN low  $V_{CEsat}$  (BISS) transistor**

Product specification  
Supersedes data of 2003 Nov 21

2004 Nov 04

**50 V, 3 A**  
**NPN low  $V_{CEsat}$  (BISS) transistor**

**PBSS4350X**

**FEATURES**

- SOT89 (SC-62) package
- Low collector-emitter saturation voltage  $V_{CEsat}$
- High collector current capability:  $I_C$  and  $I_{CM}$
- Higher efficiency leading to less heat generation
- Reduced printed-circuit board requirements.

**APPLICATIONS**

- Power management
  - DC/DC converters
  - Supply line switching
  - Battery charger
  - LCD backlighting.
- Peripheral drivers
  - Driver in low supply voltage applications (e.g. lamps and LEDs).
  - Inductive load driver (e.g. relays, buzzers and motors).

**DESCRIPTION**

NPN low  $V_{CEsat}$  transistor in a SOT89 plastic package.  
 PNP complement: PBSS5350X.

**MARKING**

TYPE NUMBER	MARKING CODE
PBSS4350X	S43

**QUICK REFERENCE DATA**

SYMBOL	PARAMETER	MAX.	UNIT
$V_{CEO}$	collector-emitter voltage	50	V
$I_C$	collector current (DC)	3	A
$I_{CM}$	peak collector current	5	A
$R_{CEsat}$	equivalent on-resistance	130	m $\Omega$

**PINNING**

PIN	DESCRIPTION
1	emitter
2	collector
3	base

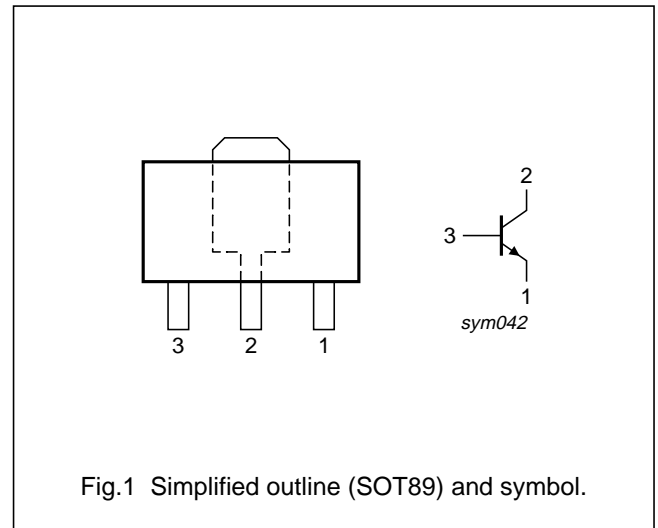

50 V, 3 A  
NPN low  $V_{CEsat}$  (BISS) transistor

PBSS4350X

**ORDERING INFORMATION**

TYPE NUMBER	PACKAGE		
	NAME	DESCRIPTION	VERSION
PBSS4350X	SC-62	plastic surface mounted package; collector pad for good heat transfer; 3 leads	SOT89

**LIMITING VALUES**

In accordance with the Absolute Maximum Rating System (IEC 60134).

SYMBOL	PARAMETER	CONDITIONS	MIN.	MAX.	UNIT
$V_{CBO}$	collector-base voltage	open emitter	–	50	V
$V_{CEO}$	collector-emitter voltage	open base	–	50	V
$V_{EBO}$	emitter-base voltage	open collector	–	5	V
$I_C$	collector current (DC)	note 4	–	3	A
$I_{CM}$	peak collector current	limited by $T_{j(max)}$	–	5	A
$I_B$	base current (DC)		–	0.5	A
$P_{tot}$	total power dissipation	$T_{amb} \leq 25\text{ °C}$ note 1 note 2 note 3 note 4	–	550 1 1.4 1.6	mW W W W
$T_{stg}$	storage temperature		–65	+150	°C
$T_j$	junction temperature		–	150	°C
$T_{amb}$	ambient temperature		–65	+150	°C

**Notes**

1. Device mounted on a FR4 printed-circuit board; single-sided copper; tin-plated; standard footprint.
2. Device mounted on a FR4 printed-circuit board; single-sided copper; tin-plated; mounting pad for collector 1 cm<sup>2</sup>.
3. Device mounted on a FR4 printed-circuit board; single-sided copper; tin-plated; mounting pad for collector 6 cm<sup>2</sup>.
4. Device mounted on a ceramic printed-circuit board 7 cm<sup>2</sup>, single-sided copper, tin-plated.

50 V, 3 A  
NPN low  $V_{CEsat}$  (BISS) transistor

PBSS4350X

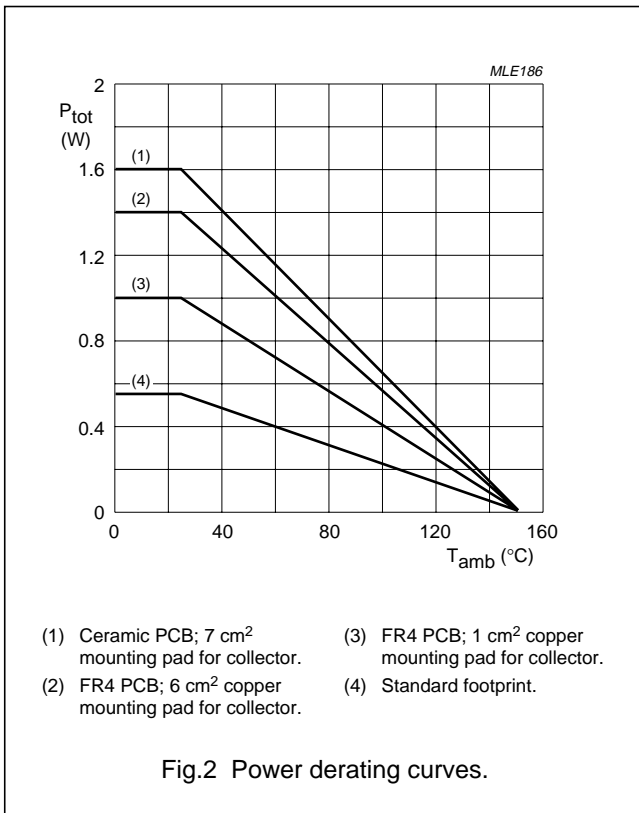

50 V, 3 A  
NPN low  $V_{CEsat}$  (BISS) transistor

PBSS4350X

**THERMAL CHARACTERISTICS**

SYMBOL	PARAMETER	CONDITIONS	VALUE	UNIT
$R_{th(j-a)}$	thermal resistance from junction to ambient	in free air		
		note 1	225	K/W
		note 2	125	K/W
		note 3	90	K/W
		note 4	80	K/W
$R_{th(j-s)}$	thermal resistance from junction to soldering point		16	K/W

**Notes**

1. Device mounted on a FR4 printed-circuit board; single-sided copper; tin-plated; standard footprint.
2. Device mounted on a FR4 printed-circuit board; single-sided copper; tin-plated; mounting pad for collector 1 cm<sup>2</sup>.
3. Device mounted on a FR4 printed-circuit board; single-sided copper; tin-plated; mounting pad for collector 6 cm<sup>2</sup>.
4. Device mounted on a ceramic printed-circuit board 7 cm<sup>2</sup>, single-sided copper, tin-plated.

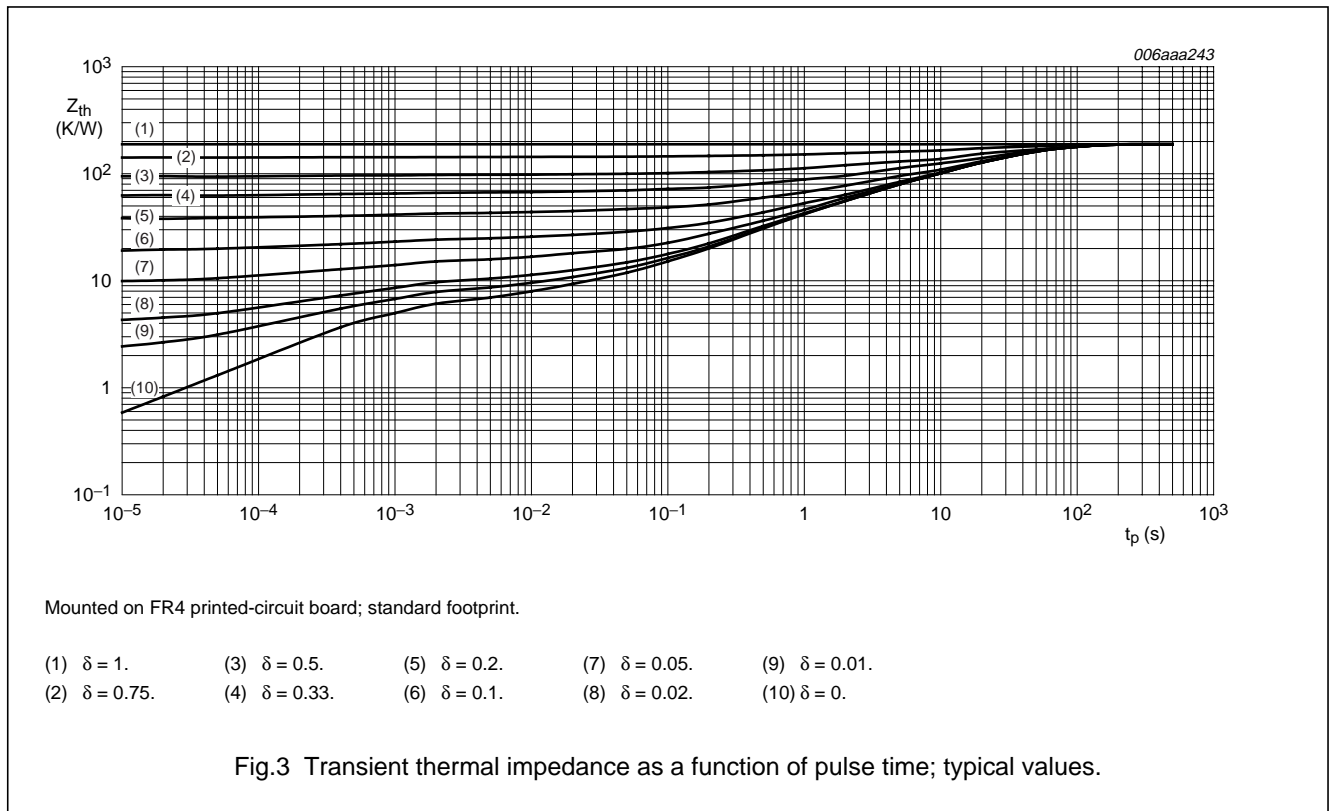

50 V, 3 A  
NPN low  $V_{CEsat}$  (BISS) transistor

PBSS4350X

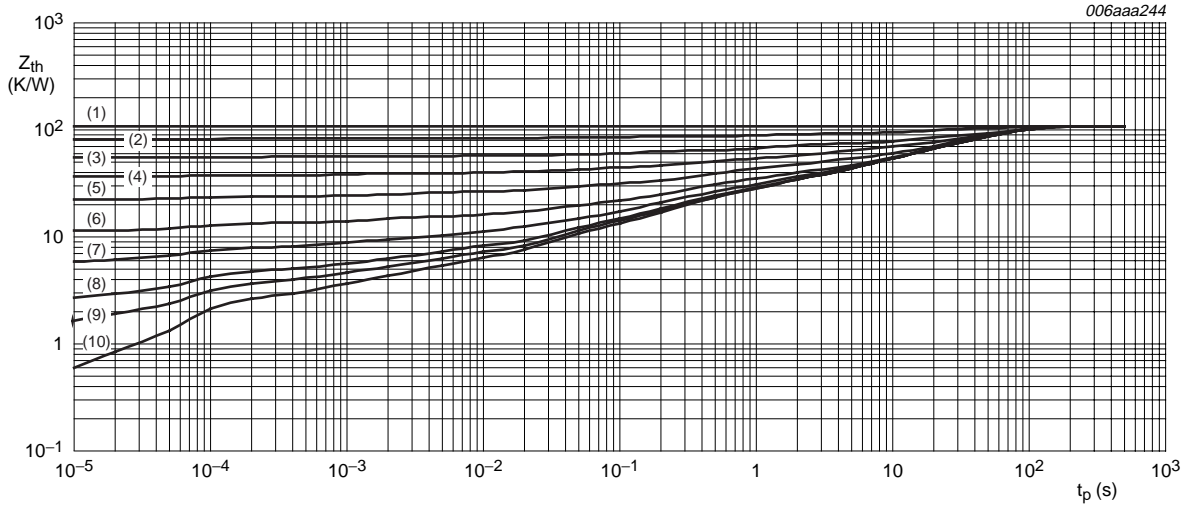

Mounted on FR4 printed-circuit board; mounting pad for collector 1 cm<sup>2</sup>.

- |                      |                      |                     |                      |                      |
|----------------------|----------------------|---------------------|----------------------|----------------------|
| (1) $\delta = 1.$    | (3) $\delta = 0.5.$  | (5) $\delta = 0.2.$ | (7) $\delta = 0.05.$ | (9) $\delta = 0.01.$ |
| (2) $\delta = 0.75.$ | (4) $\delta = 0.33.$ | (6) $\delta = 0.1.$ | (8) $\delta = 0.02.$ | (10) $\delta = 0.$   |

Fig.4 Transient thermal impedance as a function of pulse time; typical values.

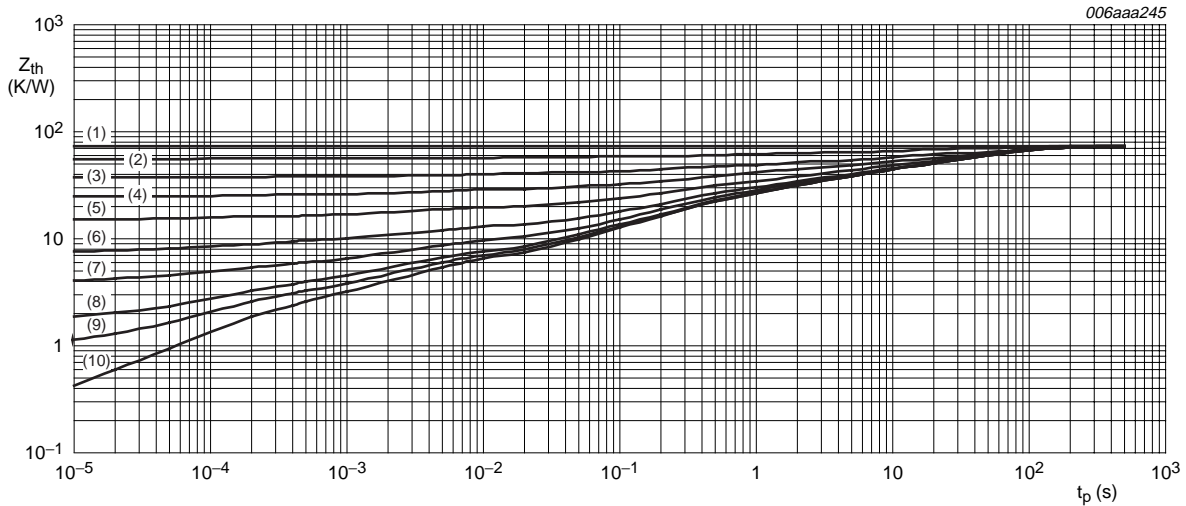

Mounted on FR4 printed-circuit board; mounting pad for collector 6 cm<sup>2</sup>.

- |                      |                      |                     |                      |                      |
|----------------------|----------------------|---------------------|----------------------|----------------------|
| (1) $\delta = 1.$    | (3) $\delta = 0.5.$  | (5) $\delta = 0.2.$ | (7) $\delta = 0.05.$ | (9) $\delta = 0.01.$ |
| (2) $\delta = 0.75.$ | (4) $\delta = 0.33.$ | (6) $\delta = 0.1.$ | (8) $\delta = 0.02.$ | (10) $\delta = 0.$   |

Fig.5 Transient thermal impedance as a function of pulse time; typical values.

50 V, 3 A  
NPN low  $V_{CEsat}$  (BISS) transistor

PBSS4350X

**CHARACTERISTICS** $T_{amb} = 25\text{ °C}$  unless otherwise specified.

SYMBOL	PARAMETER	CONDITIONS	MIN.	TYP.	MAX.	UNIT
$I_{CBO}$	collector-base cut-off current	$V_{CB} = 50\text{ V}; I_E = 0\text{ A}$	–	–	100	nA
		$V_{CB} = 50\text{ V}; I_E = 0\text{ A}; T_j = 150\text{ °C}$	–	–	50	$\mu\text{A}$
$I_{CES}$	collector-emitter cut-off current	$V_{CE} = 50\text{ V}; V_{BE} = 0\text{ V}$	–	–	100	nA
$I_{EBO}$	emitter-base cut-off current	$V_{EB} = 5\text{ V}; I_C = 0\text{ A}$	–	–	100	nA
$h_{FE}$	DC current gain	$V_{CE} = 2\text{ V}$				
		$I_C = 0.1\text{ A}$	300	–	–	
		$I_C = 0.5\text{ A}$	300	–	–	
		$I_C = 1\text{ A}; \text{note 1}$	300	–	700	
		$I_C = 2\text{ A}; \text{note 1}$	200	–	–	
$V_{CEsat}$	collector-emitter saturation voltage	$I_C = 0.5\text{ A}; I_B = 50\text{ mA}$	–	–	80	mV
		$I_C = 1\text{ A}; I_B = 50\text{ mA}$	–	–	160	mV
		$I_C = 2\text{ A}; I_B = 100\text{ mA}$	–	–	280	mV
		$I_C = 2\text{ A}; I_B = 200\text{ mA}; \text{note 1}$	–	–	260	mV
		$I_C = 3\text{ A}; I_B = 300\text{ mA}; \text{note 1}$	–	–	370	mV
$R_{CEsat}$	equivalent on-resistance	$I_C = 2\text{ A}; I_B = 200\text{ mA}; \text{note 1}$	–	100	130	$\text{m}\Omega$
$V_{BEsat}$	base-emitter saturation voltage	$I_C = 2\text{ A}; I_B = 100\text{ mA}$	–	–	1.1	V
		$I_C = 3\text{ A}; I_B = 300\text{ mA}; \text{note 1}$	–	–	1.2	V
$V_{BEon}$	base-emitter turn-on voltage	$V_{CE} = 2\text{ V}; I_C = 1\text{ A}$	1.1	–	–	V
$f_T$	transition frequency	$I_C = 100\text{ mA}; V_{CE} = 5\text{ V}; f = 100\text{ MHz}$	100	–	–	MHz
$C_c$	collector capacitance	$V_{CB} = 10\text{ V}; I_E = I_e = 0\text{ A}; f = 1\text{ MHz}$	–	–	25	pF

**Note**

1. Pulse test:  $t_p \leq 300\text{ }\mu\text{s}$ ;  $\delta \leq 0.02$ .

50 V, 3 A  
NPN low  $V_{CEsat}$  (BISS) transistor

PBSS4350X

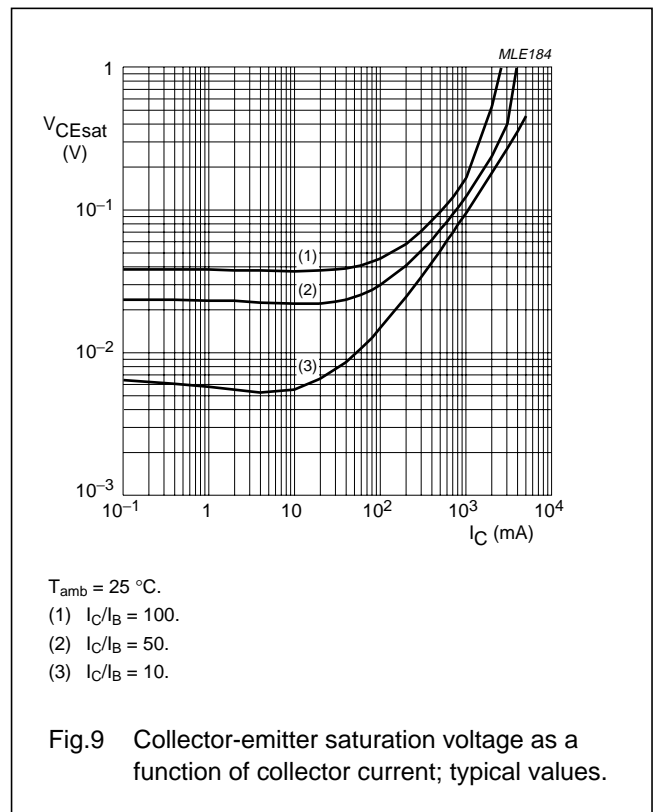
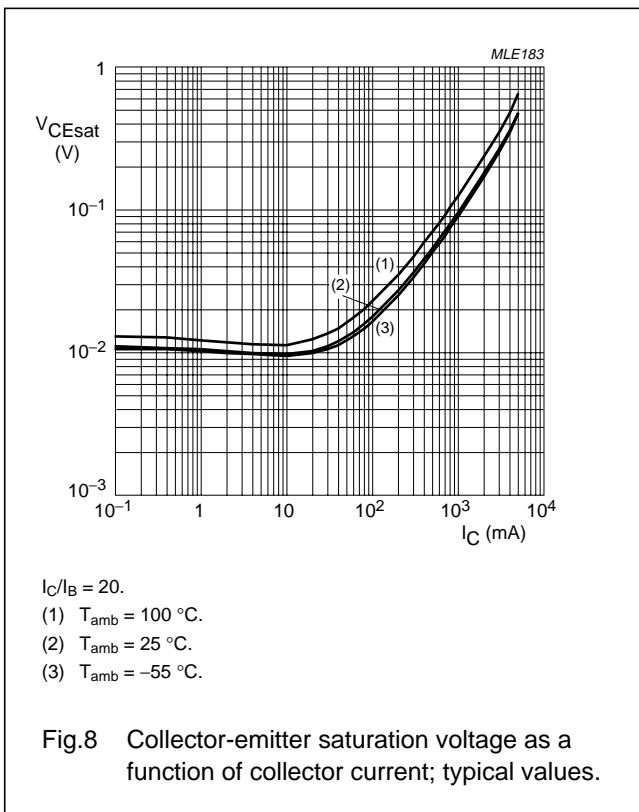
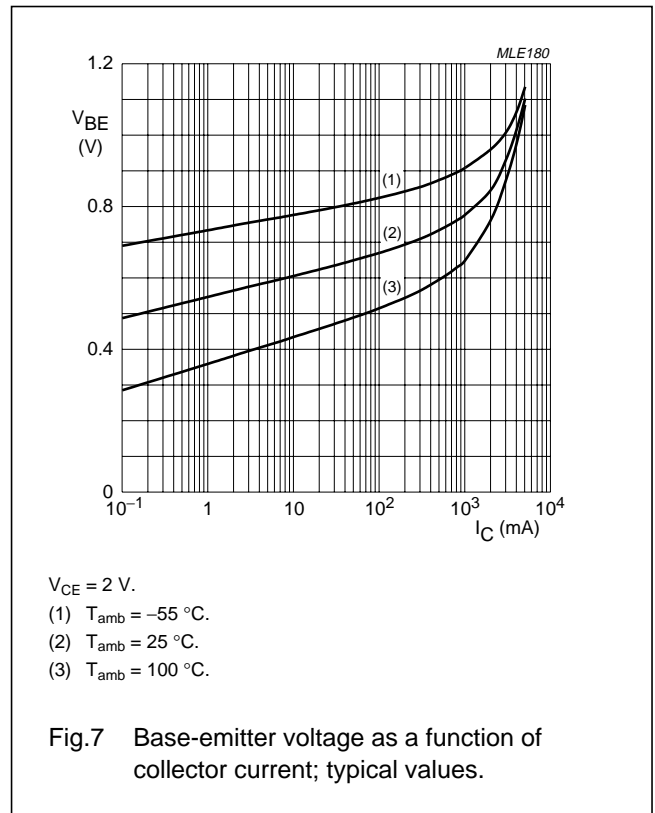
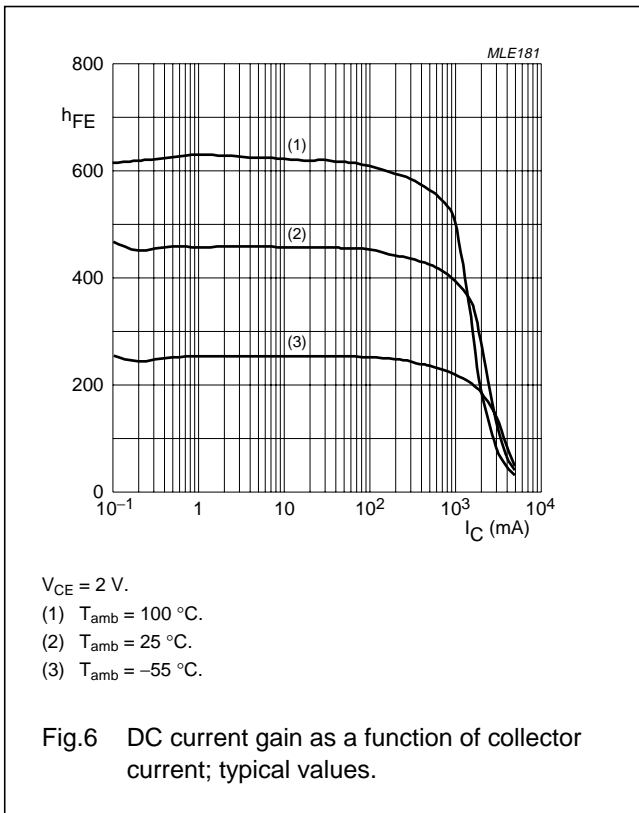



50 V, 3 A  
NPN low  $V_{CEsat}$  (BISS) transistor

PBSS4350X

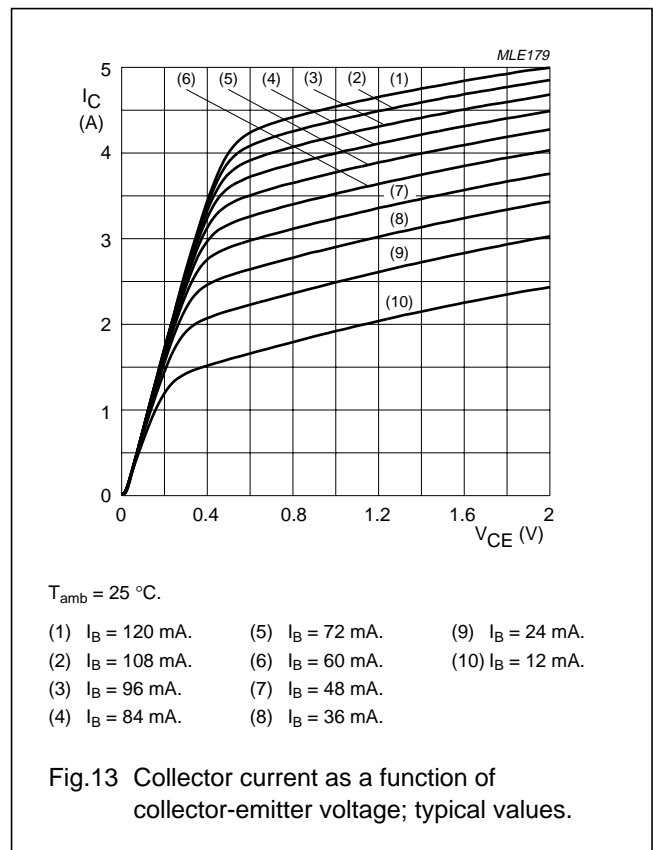
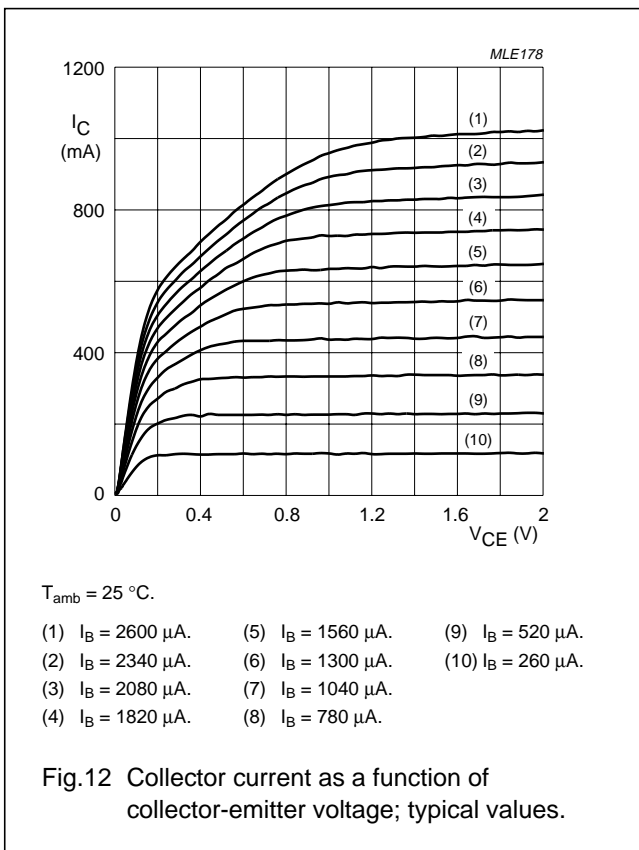
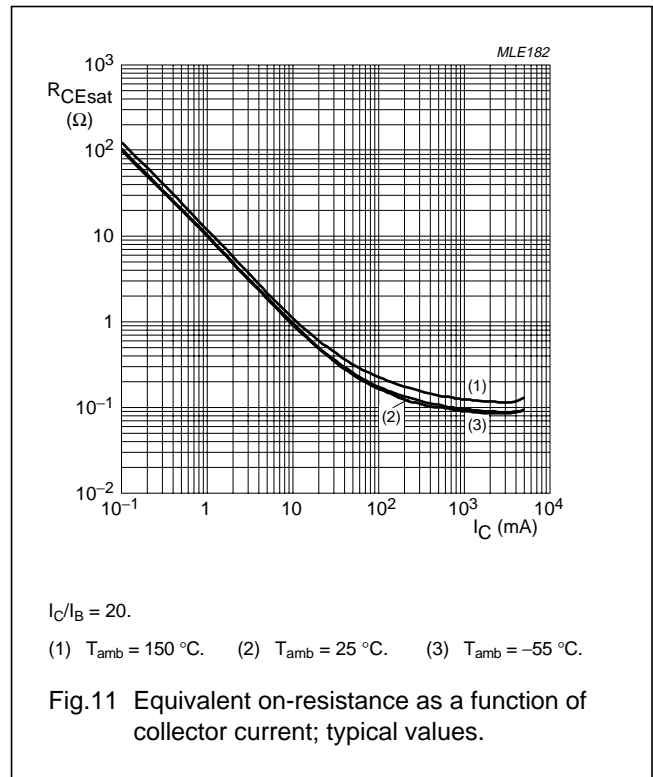
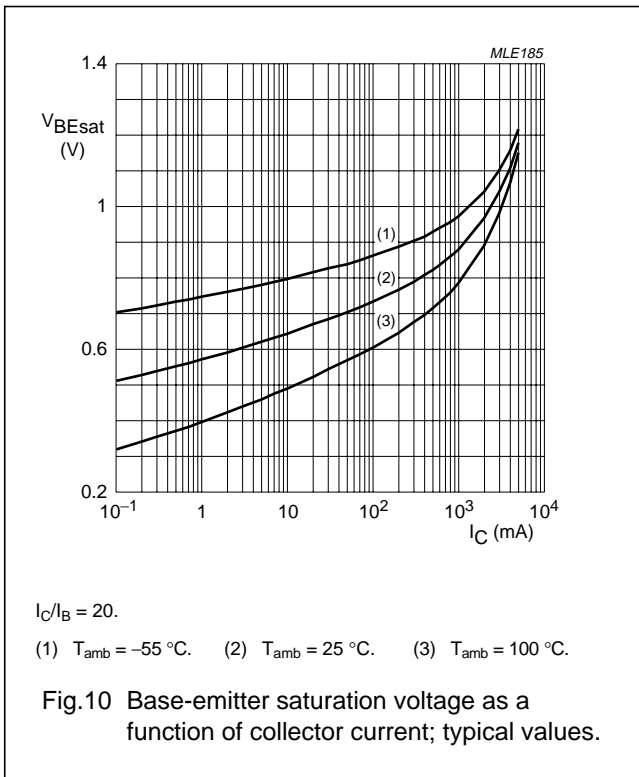

50 V, 3 A  
NPN low  $V_{CEsat}$  (BISS) transistor

PBSS4350X

PACKAGE OUTLINE

Plastic surface mounted package; collector pad for good heat transfer; 3 leads

SOT89

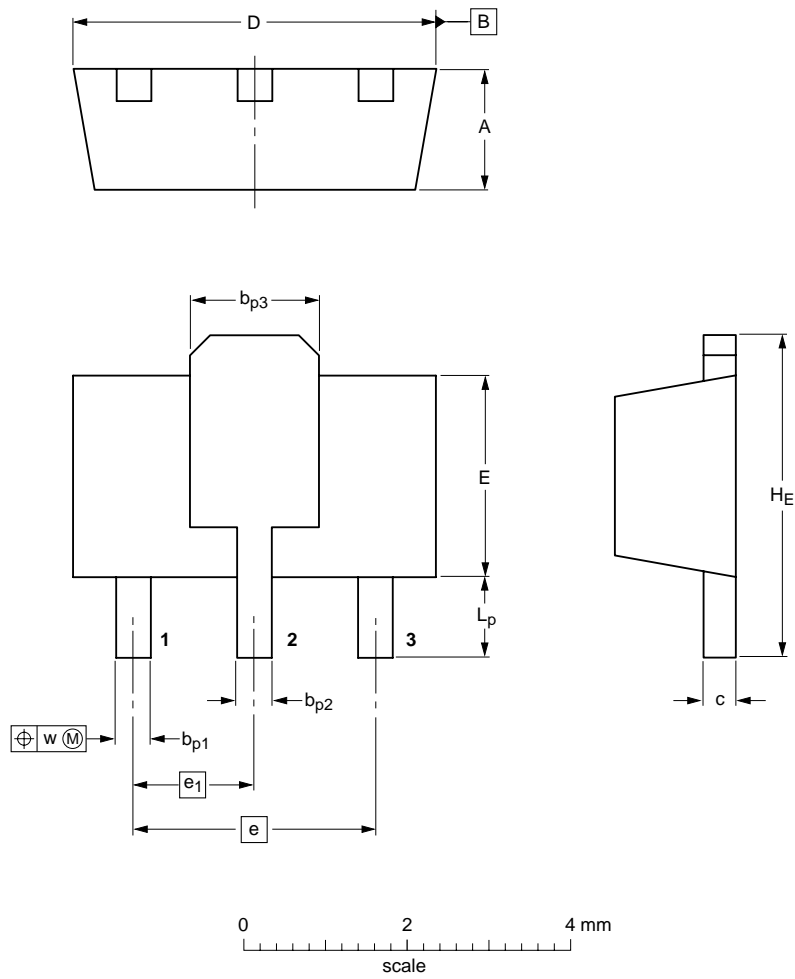

DIMENSIONS (mm are the original dimensions)

UNIT	A	bp1	bp2	bp3	c	D	E	e	e1	HE	Lp	w
mm	1.6 1.4	0.48 0.35	0.53 0.40	1.8 1.4	0.44 0.23	4.6 4.4	2.6 2.4	3.0	1.5	4.25 3.75	1.2 0.8	0.13

OUTLINE VERSION	REFERENCES			EUROPEAN PROJECTION	ISSUE DATE
	IEC	JEDEC	JEITA		
SOT89		TO-243	SC-62		99-09-13 04-08-03

50 V, 3 A  
NPN low  $V_{CEsat}$  (BISS) transistor

PBSS4350X

## DATA SHEET STATUS

LEVEL	DATA SHEET STATUS <sup>(1)</sup>	PRODUCT STATUS <sup>(2)(3)</sup>	DEFINITION
I	Objective data	Development	This data sheet contains data from the objective specification for product development. Philips Semiconductors reserves the right to change the specification in any manner without notice.
II	Preliminary data	Qualification	This data sheet contains data from the preliminary specification. Supplementary data will be published at a later date. Philips Semiconductors reserves the right to change the specification without notice, in order to improve the design and supply the best possible product.
III	Product data	Production	This data sheet contains data from the product specification. Philips Semiconductors reserves the right to make changes at any time in order to improve the design, manufacturing and supply. Relevant changes will be communicated via a Customer Product/Process Change Notification (CPCN).

## Notes

1. Please consult the most recently issued data sheet before initiating or completing a design.
2. The product status of the device(s) described in this data sheet may have changed since this data sheet was published. The latest information is available on the Internet at URL <http://www.semiconductors.philips.com>.
3. For data sheets describing multiple type numbers, the highest-level product status determines the data sheet status.

## DEFINITIONS

**Short-form specification** — The data in a short-form specification is extracted from a full data sheet with the same type number and title. For detailed information see the relevant data sheet or data handbook.

**Limiting values definition** — Limiting values given are in accordance with the Absolute Maximum Rating System (IEC 60134). Stress above one or more of the limiting values may cause permanent damage to the device. These are stress ratings only and operation of the device at these or at any other conditions above those given in the Characteristics sections of the specification is not implied. Exposure to limiting values for extended periods may affect device reliability.

**Application information** — Applications that are described herein for any of these products are for illustrative purposes only. Philips Semiconductors make no representation or warranty that such applications will be suitable for the specified use without further testing or modification.

## DISCLAIMERS

**Life support applications** — These products are not designed for use in life support appliances, devices, or systems where malfunction of these products can reasonably be expected to result in personal injury. Philips Semiconductors customers using or selling these products for use in such applications do so at their own risk and agree to fully indemnify Philips Semiconductors for any damages resulting from such application.

**Right to make changes** — Philips Semiconductors reserves the right to make changes in the products - including circuits, standard cells, and/or software - described or contained herein in order to improve design and/or performance. When the product is in full production (status 'Production'), relevant changes will be communicated via a Customer Product/Process Change Notification (CPCN). Philips Semiconductors assumes no responsibility or liability for the use of any of these products, conveys no licence or title under any patent, copyright, or mask work right to these products, and makes no representations or warranties that these products are free from patent, copyright, or mask work right infringement, unless otherwise specified.

# ***Philips Semiconductors – a worldwide company***

## **Contact information**

For additional information please visit <http://www.semiconductors.philips.com>. Fax: +31 40 27 24825

For sales offices addresses send e-mail to: [sales.addresses@www.semiconductors.philips.com](mailto:sales.addresses@www.semiconductors.philips.com).

© Koninklijke Philips Electronics N.V. 2004

SCA76

All rights are reserved. Reproduction in whole or in part is prohibited without the prior written consent of the copyright owner.

The information presented in this document does not form part of any quotation or contract, is believed to be accurate and reliable and may be changed without notice. No liability will be accepted by the publisher for any consequence of its use. Publication thereof does not convey nor imply any license under patent- or other industrial or intellectual property rights.

Printed in The Netherlands

R75/03/pp12

Date of release: 2004 Nov 04

Document order number: 9397 750 13883

*Let's make things better.*

**Philips  
Semiconductors**



**PHILIPS**