



SAA7134HL

PCI audio and video broadcast decoder

Rev. 04 — 31 March 2006

Product data sheet

1. General description

The SAA7134HL is a single chip solution to digitize and decode video and sound, and to capture both data streams through the PCI-bus.

Special means are incorporated to maintain the synchronization of audio to video. The device offers versatile peripheral interfaces (GPIO), that support various extended applications, e.g. analog audio pass-through for loop back cable to the sound card, or capture of DTV and DVB transport streams, such as Vestigial Side Band (VSB), Orthogonal Frequency Division Multiplexing (OFDM) and Quadrature Amplitude Modulation (QAM) decoded digital television standards, see [Figure 1](#).

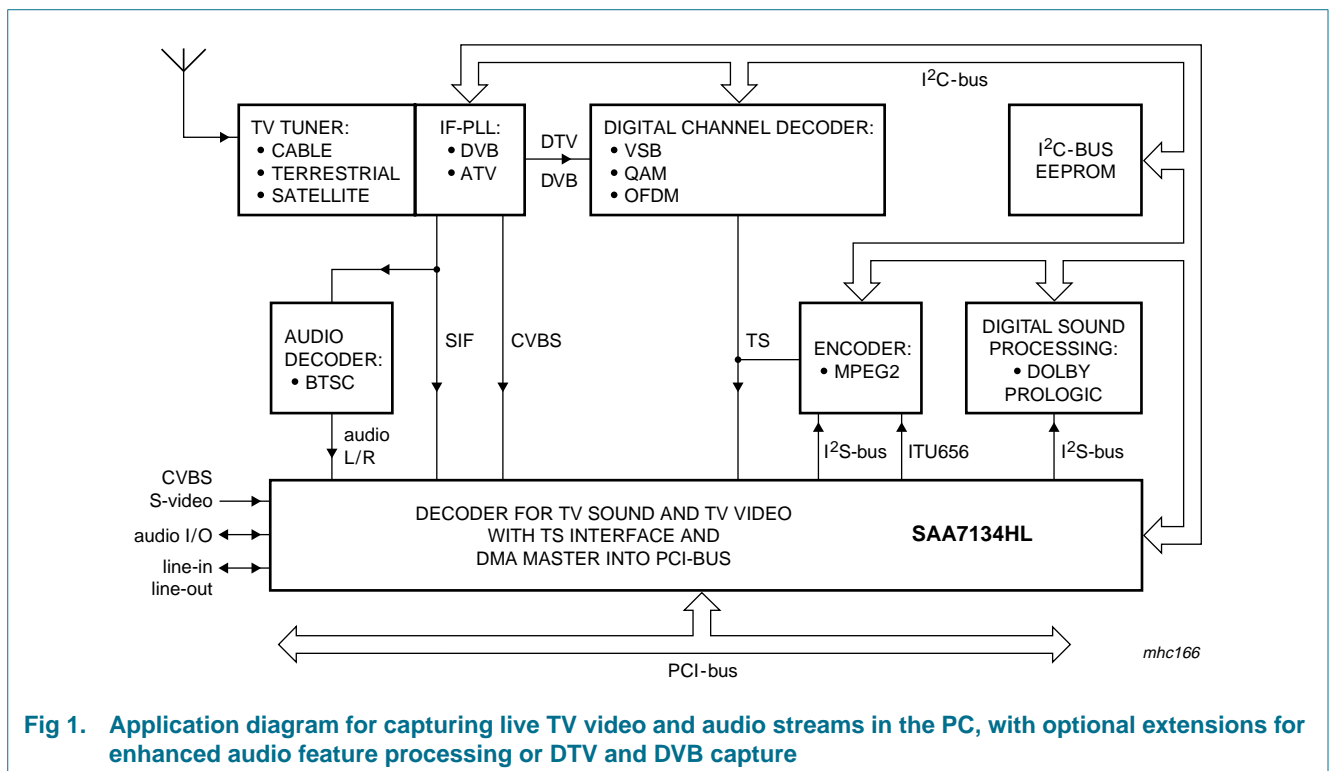

Fig 1. Application diagram for capturing live TV video and audio streams in the PC, with optional extensions for enhanced audio feature processing or DTV and DVB capture

1.1 Introduction

The PCI audio and video broadcast decoder SAA7134HL is a highly integrated, low cost and solid foundation for TV capture in the PC, for analog TV and digital video broadcast. The various multimedia data types are transported over the PCI-bus by bus-master-write, to optimally exploit the streaming capabilities of a modern host based system. Legacy requirements are also taken care of.

The SAA7134HL meets the requirements of *PC design guides 98/99 and 2001* and is PCI 2.2 and Advanced Configuration and Power Interface (ACPI) compliant.

The analog video is sampled by 9-bit ADCs, decoded by a multi-line adaptive comb filter and scaled horizontally, vertically and by field rate. Multiple video output formats (YUV and RGB) are available, including packed and planar, gamma-compensated or black-stretched.

Analog TV sound is digitized and stereo decoded (NICAM and dual FM standards). Audio is streamed digitally via the PCI-bus or routed as an analog signal via the loop back cable to the sound card.

The SAA7134HL provides a versatile peripheral interface to support system extensions, e.g. MPEG encoding for time shift viewing, or DSP applications for audio enhancements.

The channel decoder for digital video broadcast reception (ATSC or DVB) can re-use the integrated video ADCs.

The Transport Stream (TS) is collected by a tailored interface and pumped through the PCI-bus to the system memory in well-defined buffer structures. Various internal events, or peripheral status information, can be enabled as an interrupt on the PCI-bus.

1.2 Overview of TV decoders with PCI bridge

A TV decoder family with PCI interfacing has been created to support worldwide TV broadcasting. The pin compatibility of these TV decoders offers the opportunity to support different TV broadcast standards with one PCB layout.

Table 1: TV decoder family with PCI interfacing

TV parameter		TV decoder type ^[1]			
		SAA7130HL	SAA7133HL	SAA7134HL	SAA7135HL
PCI bridge	version	2.2	2.2	2.2	2.2
	DMA channel	7	7	7	7
TV video decoding	PAL, NTSC and SECAM	X	X	X	X
Video scaling	2 dimension and 2 task scaler	X	X	X	X
Raw VBI	27 MHz sampling rate	X	X	X	X
TV sound decoding	FM A2 and NICAM	-	-	X	X
	BTSC (dbx-TV) plus SAP; EIAJ	-	X	-	X
	stereo sampling (I ² S-bus and DMA)	-	32 kHz	32 kHz, 48 kHz	32 kHz, 48 kHz
Radio	FM radio stereo	-	X	-	X

Table 1: TV decoder family with PCI interfacing...continued

TV parameter		TV decoder type [1]			
		SAA7130HL	SAA7133HL	SAA7134HL	SAA7135HL
Audio	left and right pass-through	X	X	X	X
	stereo sampling (I ² S-bus and DMA)	-	32 kHz, 44.1 kHz, 48 kHz	32 kHz, 44.1 kHz, 48 kHz	32 kHz, 44.1 kHz, 48 kHz
	video frame locked audio	-	X	X	X
	incredible surround	-	X	X	X
	volume, bass and treble control	-	X	volume only	X
Transport stream	serial and parallel TS	X	X	X	X
GPIO	static I/O pins	27	27	27	27
	interrupt input pins	4	4	4	4
	I ² C-bus multi-master or slave	X	X	X	X
	video out	X	X	X	X

[1] X = function available.

1.3 Related documents

This document describes the functionality and characteristics of the SAA7134HL.

Other documents related to the SAA7134HL are:

- *User manual SAA7130HL/34HL*, describing the programmability
- *Application note SAA7130HL/34HL*, pointing out recommendations for system implementation
- Demonstration and reference boards, including description, schematics, etc.:
 - Proteus-Pro: TV capture PCI card for analog TV (standards: B/G, I, D/K and L/L)
 - Europe: hybrid DVB-T and analog TV capture PCI card for European broadcasting
- Data sheets of other devices referred to in this document, e.g:
 - *TDA9852*: BTSC stereo decoder
 - Tuners:
 - F11216* for PAL B/G
 - F11216MF* for PAL B/G + SECAM
 - F11246* for PAL I
 - F11256* for PAL D/K
 - *TD1316*: ATV+DVB-T tuner
 - *TDA10045*: DVB channel receiver
 - *TDA9886*: analog IF-PLL
 - *TDA9889*: digital IF-PLL

- SAA6752HS: MPEG-2 video and MPEG-audio/AC-3 audio encoder with multiplexer

2. Features

2.1 PCI and DMA bus mastering

- PCI 2.2 compliant including full Advanced Configuration and Power Interface (ACPI)
- System vendor ID, etc. via EEPROM
- Hardware support for virtual addressing by MMU
- DMA bus master write for video, audio, VBI and TS
- Configurable PCI FIFOs, graceful overflow
- Packed and planar video formats, overlay clipping

2.2 TV video decoder and video scaling

- All-standards TV decoder: NTSC, PAL and SECAM
- Five analog video inputs: CVBS and S-video
- Video digitizing by two 9-bit ADCs at 27 MHz
- Sampling according *ITU-R BT.601* with 720 pixels/line
- Adaptive comb filter for NTSC and PAL, also operating for non-standard signals
- Automatic TV standard detection
- Three level Macrovision copy protection detection according to Macrovision detect specification revision 1
- Control of brightness, contrast, saturation and hue
- Versatile filter bandwidth selection
- Horizontal and vertical downscaling or zoom
- Adaptive anti-alias filtering
- Capture of raw VBI samples
- Two alternating settings for active video scaling
- Output in YUV and RGB
- Gamma compensation, black stretching

2.3 TV sound decoder and audio I/O

- TV stereo decoding for NICAM and dual FM
- Audio sampling locked to video field rate, no drift of audio stream against video stream
- On-chip stereo audio ADCs and DACs (2×16 -bit)
- Sampling rate, e.g. 32 kHz, 44.1 kHz and 48 kHz
- Integrated analog audio pass-through for analog audio loop back cable to sound card

2.4 Peripheral interface

- I²C-bus master interface: 3.3 V and 5 V
- Digital video output: ITU and VIP formats
- TS input: serial or parallel
- General purpose I/O, e.g. for strapping and interrupt

- Propagate reset and ACPI state D3-hot

2.5 General

- Package: LQFP128
- Power supply: 3.3 V only
- Power consumption of typical application: 1.1 W
- Standby state (D3-hot): < 0.02 W
- All interface signals 5 V tolerant
- Reference designs available
- SDK for Windows (98, 2000 and XP) and Windows Driver Model (WDM)

3. Ordering information

Table 2: Ordering information

Type number	Package		
	Name	Description	Version
SAA7134HL	LQFP128	plastic low profile quad flat package; 128 leads; body 14 × 20 × 1.4 mm	SOT425-1

4. Block diagram

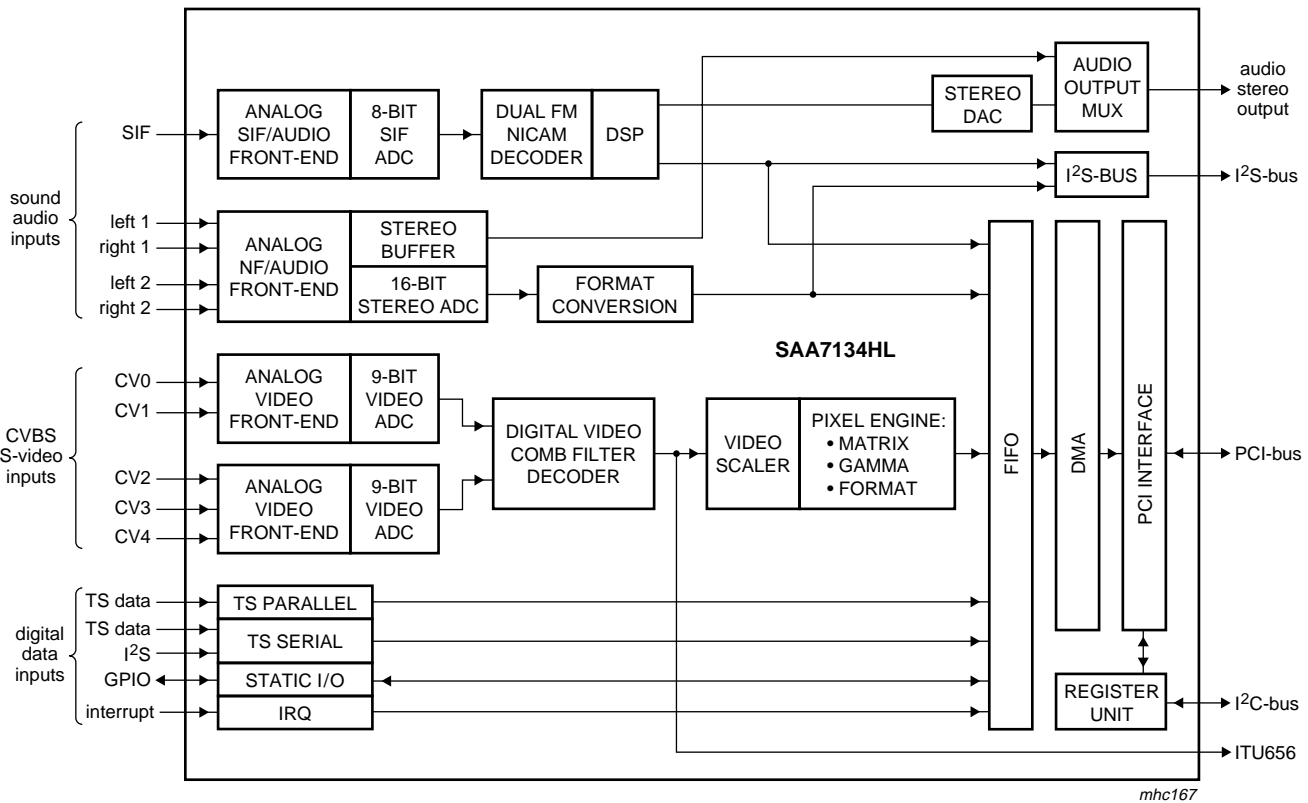

Fig 2. Block diagram

5. Pinning information

5.1 Pinning

The SAA7134HL is packaged in a rectangular Low profile Quad Flat Package (LQFP) with 128 pins, see [Figure 3](#).

All the pins are shown sorted by number in [Table 3](#).

Functional pin groupings are given in the following tables:

Power supply pins: [Table 4](#)

PCI interface pins: [Table 5](#)

Analog interface pins: [Table 6](#)

Joint Test Action Group (JTAG) test interface pins for boundary scan test: [Table 7](#)

I²C-bus multi-master interface: [Table 8](#)

General purpose interface (pins GPIO) and the main functions: [Table 9](#)

The characteristics of the pin types are detailed in [Table 10](#).

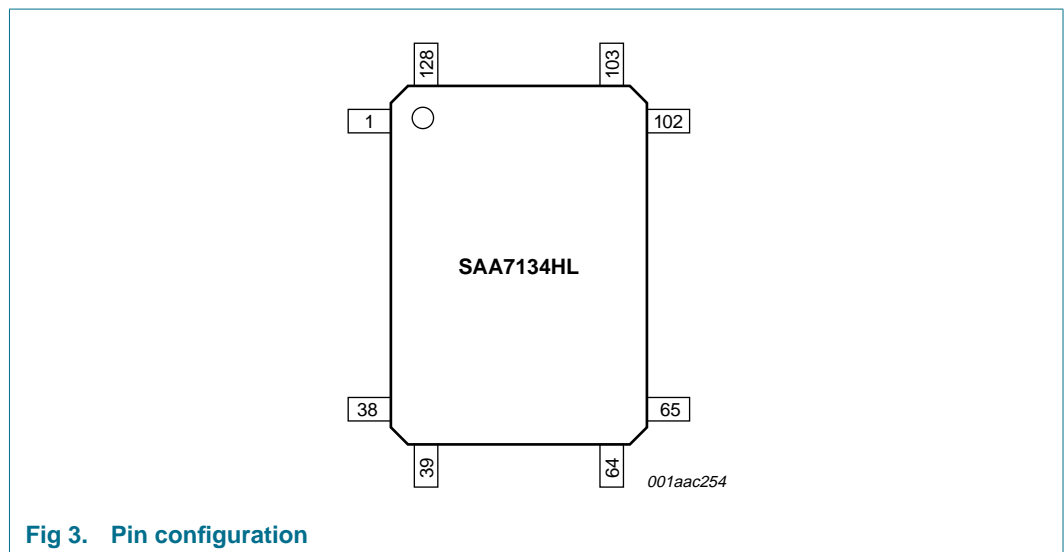

Fig 3. Pin configuration

Table 3: Pin allocation table

Pin	Symbol	Pin	Symbol	Pin	Symbol	Pin	Symbol
1	V _{DDD}	33	C/BE[1]#	65	V _{DDD}	97	V _{SSA}
2	GNT#	34	AD[15]	66	V _{CLK}	98	RIGHT1
3	REQ#	35	AD[14]	67	GPIO17	99	V _{REF0}
4	AD[31]	36	AD[13]	68	GPIO16	100	RIGHT2
5	AD[30]	37	AD[12]	69	GPIO15	101	V _{REF1}
6	AD[29]	38	V _{DDD}	70	GPIO14	102	V _{REF2}
7	AD[28]	39	V _{SSD}	71	GPIO13	103	OUT_RIGHT
8	AD[27]	40	PCI_CLK	72	GPIO12	104	OUT_LEFT
9	AD[26]	41	AD[11]	73	V _{DDD}	105	PROP_RST_N

Table 3: Pin allocation table...continued

Pin	Symbol	Pin	Symbol	Pin	Symbol	Pin	Symbol
10	AD[25]	42	AD[10]	74	V _{SSD}	106	SIF
11	AD[24]	43	AD[09]	75	GPIO11	107	V _{REF3}
12	C/BE[3]#	44	AD[08]	76	GPIO10	108	V _{SSA}
13	IDSEL	45	C/BE[0]#	77	GPIO9	109	CV2_C
14	AD[23]	46	AD[07]	78	GPIO8	110	V _{DDA}
15	AD[22]	47	AD[06]	79	GPIO7	111	V _{REF4}
16	AD[21]	48	AD[05]	80	GPIO6	112	DRCV_Y
17	AD[20]	49	AD[04]	81	GPIO5	113	V _{SSA}
18	AD[19]	50	AD[03]	82	GPIO4	114	CV0_Y
19	V _{DDD}	51	AD[02]	83	GPIO3	115	V _{DDA}
20	V _{SSD}	52	AD[01]	84	GPIO2	116	CV1_Y
21	AD[18]	53	AD[00]	85	GPIO1	117	DRCV_C
22	AD[17]	54	V _{DDD}	86	GPIO0	118	CV3_C
23	AD[16]	55	V _{SSD}	87	GPIO27	119	V _{SSA}
24	C/BE[2]#	56	GPIO23	88	GPIO26	120	CV4
25	FRAME#	57	GPIO22	89	GPIO25	121	TRST_N
26	IRDY#	58	GPIO21	90	SCL	122	TCK
27	TRDY#	59	GPIO20	91	SDA	123	TMS
28	DEVSEL#	60	GPIO19	92	V _{DDD}	124	TDO
29	STOP#	61	GPIO18	93	V _{SSD}	125	TDI
30	PERR#	62	XTALI	94	LEFT2	126	INT_A
31	SERR#	63	XTALO	95	V _{DDA}	127	PCI_RST#
32	PAR	64	V _{SSD}	96	LEFT1	128	V _{SSD}

5.2 Pin description

Table 4: Power supply pins

Symbol	Pin	Type	Description
V _{SSA}	97, 108, 113 and 119	AG	analog ground for integrated analog signal processing
V _{DDA}	95, 110 and 115	AS	analog supply voltage for integrated analog signal processing
V _{SSD}	20, 39, 55, 64, 74, 93 and 128	VG	digital ground for digital circuit, core and input/outputs
V _{DDD}	1, 19, 38, 54, 65, 73 and 92	VS	digital supply voltage for digital circuit, core and input/outputs

Table 5: PCI interface pins [1]

Symbol	Pin	Type	Description
PCI_CLK	40	PI	PCI clock input: reference for all bus transactions, up to 33.33 MHz
PCI_RST#	127	PI	PCI reset input: will 3-state all PCI pins (active LOW)
AD[31] to AD[00]	4 to 11, 14 to 18, 21 to 23, 34 to 37, 41 to 44 and 46 to 53	PIO and T/S	multiplexed address and data input or output: bi-directional, 3-state
C/BE[3]# to C/BE[0]#	12, 24, 33 and 45	PIO and T/S	command code input or output: indicates type of requested transaction and byte enable, for byte aligned transactions (active LOW)
PAR	32	PIO and T/S	parity input or output: driven by the data source, even parity over all pins AD and C/BE#
FRAME#	25	PIO and S/T/S	frame input or output: driven by the current bus master (owner), to indicate the beginning and duration of a bus transaction (active LOW)
TRDY#	27	PIO and S/T/S	target ready input or output: driven by the addressed target, to indicate readiness for requested transaction (active LOW)
IRDY#	26	PIO and S/T/S	initiator ready input or output: driven by the initiator, to indicate readiness to continue transaction (active LOW)
STOP#	29	PIO and S/T/S	stop input or output: target is requesting the master to stop the current transaction (active LOW)
IDSEL	13	PI	initialization device select input: this input is used to select the SAA7134HL during configuration read and write transactions
DEVSEL#	28	PIO and S/T/S	device select input or output: driven by the target device, to acknowledge address decoding (active LOW)
REQ#	3	PO	PCI request output: the SAA7134HL requests master access to PCI-bus (active LOW)
GNT#	2	PI	PCI grant input: the SAA7134HL is granted to master access PCI-bus (active LOW)
INT_A	126	PO and O/D	interrupt A output: this pin is an open-drain interrupt output, conditions assigned by the interrupt register
PERR#	30	PIO and S/T/S	parity error input or output: the receiving device detects data parity error (active LOW)
SERR#	31	PO and O/D	system error output: reports address parity error (active LOW)

[1] PCI-bus pins are located on the long side of the package to simplify PCI board layout requirements.

Table 6: Analog interface pins [1]

Symbol	Pin	Type	Description
XTALI	62	CI	quartz oscillator input: 32.11 MHz or 24.576 MHz
XTALO	63	CO	quartz oscillator output
LEFT2	94	AI	analog audio stereo left 2 input or mono input

Table 6: Analog interface pins [\[1\]](#)...continued

Symbol	Pin	Type	Description
V _{DDA}	95	AS	analog supply voltage (3.3 V)
LEFT1	96	AI	analog audio stereo left 1 input or mono input; default analog pass-through to pin OUT_LEFT after reset
V _{SSA}	97	AG	analog ground (for audio)
RIGHT1	98	AI	analog audio stereo right 1 input or mono input; default analog pass-through to pin OUT_RIGHT after reset
V _{REF0}	99	AR	analog reference ground for audio Sigma Delta ADC; to be connected directly to analog ground (V _{SSA})
RIGHT2	100	AI	analog audio stereo right 2 input or mono input
V _{REF1}	101	AR	analog reference voltage for audio Sigma Delta ADC; to be connected directly to analog supply voltage (V _{DDA}) and via a 220 nF capacitor to pin V _{REF0}
V _{REF2}	102	AR	analog reference voltage for audio Sigma Delta ADC; to be supported with two parallel capacitors of 47 μ F and 0.1 μ F to analog ground (V _{SSA})
OUT_RIGHT	103	AO	analog audio stereo right channel output; 1 V (RMS) line-out, feeding the audio loop back cable via a coupling capacitor of 2.2 μ F
OUT_LEFT	104	AO	analog audio stereo left channel output; 1 V (RMS) line-out, feeding the audio loop back cable via a coupling capacitor of 2.2 μ F
PROP_RST_N	105	AO	analog output for test and debug purposes (active LOW)
SIF	106	AI	sound IF input from TV tuner (4.5 MHz to 9.2 MHz); coupling capacitor of 47 pF after the termination with 50 Ω
V _{REF3}	107	AR	analog reference voltage for audio FIR-DAC and SCART audio input buffer; to be supported with two parallel capacitors of 47 μ F and 0.1 μ F to analog ground (V _{SSA})
V _{SSA}	108	AG	analog ground
CV2_C	109	AI	composite video input (mode 2) or C input (modes 6 and 8)
V _{DDA}	110	AS	analog power supply (3.3 V)
V _{REF4}	111	AR	analog reference voltage; to be supported with a capacitor of 220 nF to analog ground (V _{SSA})
DRCV_Y	112	AR	differential reference connection (for CV0 and CV1); to be supported with a capacitor of 47 nF to analog ground (V _{SSA})
V _{SSA}	113	AG	analog ground
CV0_Y	114	AI	composite video input (mode 0) or Y input (modes 6 and 8)
V _{DDA}	115	AS	analog supply voltage (3.3 V)
CV1_Y	116	AI	composite video input (mode 1) or Y input (modes 7 and 9)
DRCV_C	117	AR	differential reference connection (for CV2, CV3 and CV4); to be supported with a capacitor of 47 nF to analog ground (V _{SSA})

Table 6: Analog interface pins [1]...continued

Symbol	Pin	Type	Description
CV3_C	118	AI	composite video input (mode 3) or C input (modes 7 and 9)
V _{SSA}	119	AG	analog ground
CV4	120	AI	composite video input (mode 4)

[1] The SAA7134HL offers an interface for analog video and audio signals. The related analog supply pins are included in this table.

Table 7: JTAG test interface pins

Symbol	Pin	Type	Description
TRST_N	121	I	test reset input: drive LOW for normal operating (active LOW)
TCK	122	I	test clock input: drive LOW for normal operating
TMS	123	I	test mode select input: tie HIGH or let float for normal operating
TDO	124	O	test serial data output: 3-state
TDI	125	I	test serial data input: tie HIGH or let float for normal operating

Table 8: I²C-bus multi-master interface

Symbol	Pin	Type	Description
SCL	90	IO2	serial clock input (slave mode) or output (multi-master mode)
SDA	91	IO2	serial data input and output; always available
PROP_RST_N	105	GO	propagate reset and D3-hot output; to peripheral board circuitry

Table 9: GPIO pins and functions [1]

Symbol	Pin	Type	Function			
			Audio and video port outputs	TS capture inputs	Raw DTV/DVB outputs	GPIO
GPIO27	87	GIO	A_SDO (I ² S-bus data)	-	-	R/W
GPIO26	88	GIO	A_WS (I ² S-bus word select)	-	-	R/W
GPIO25	89	GIO	A_SCK (I ² S-bus clock)	-	-	R/W
V_CLK	66	GO	V_CLK (also gated)	-	ADC_CLK (out)	-
GPIO23	56	GIO	HSYNC	-	ADC_C[0] (LSB)	R/W, INT
GPIO22	57	GIO	VSYNC	TS_LOCK (channel decoder locked)	-	R/W, INT
GPIO21	58	GIO	-	TS_S_D (bit-serial data)	-	R/W
GPIO20	59	GIO	-	TS_CLK (< 33 MHz)	-	R/W

Table 9: GPIO pins and functions [1]...continued

Symbol	Pin	Type	Function			
			Audio and video port outputs	TS capture inputs	Raw DTV/DVB outputs	GPIO
GPIO19	60	GIO	-	TS_SOP (packet start)	-	R/W
GPIO18	61	GIO	VAUX2	-	X_CLK_IN	R/W, INT
GPIO17	67	GIO	VAUX1 (e.g. VACTIVE)	-	ADC_Y[0] (LSB)	R/W
GPIO16	68	GIO	-	TS_VAL (valid flag)	-	R/W, INT
GPIO15 to GPIO8	69 to 72 and 75 to 78	GIO	VP[7:0] for formats: <i>ITU-R BT.656</i> , VMI, VIP (1.1, 2.0), etc.	-	ADC_Y[8:1]	R/W
GPIO7 to GPIO0	79 to 86	GIO	VP extension for 16-bit formats: ZV, VIP-2, DMDS, etc.	TS_P_D[7:0] (byte-parallel data)	ADC_C[8:1]	R/W

- [1] The SAA7134HL offers a peripheral interface with General Purpose Input/Output (GPIO) pins. Dedicated functions can be selected:
- Digital Video Port (VP): output only; in 8-bit and 16-bit formats, such as VMI, DMDS (*ITU-R BT.601*); zoom-video, with discrete sync signals; *ITU-R BT.656*; VIP (1.1 and 2.0), with sync encoded in SAV and EAV codes.
 - Transport Stream (TS) capture input: from the peripheral DTV/DVB channel decoder; synchronized by Start Of Packet (SOP); in byte-parallel or bit-serial protocol.
 - Digitized raw DTV/DVB samples stream output: from internal ADCs; to feed the peripheral DTV/DVB channel decoder.
 - GPIO: as default (no other function selected); static (no clock); read and write from or to individually selectable pins; latching 'strap' information at system reset time.
 - Peripheral interrupt (INT) input: enabled by interrupt enable register; routed to PCI interrupt (INT_A).

5.2.1 Pin type description

Table 10: Characteristics of pin types and remarks

Pin type	Description
AG	analog ground
AI	analog input; video, audio and sound
AO	analog output
AR	analog reference support pin
AS	analog supply voltage (3.3 V)
CI	CMOS input; 3.3 V level (not 5 V tolerant)
CO	CMOS output; 3.3 V level (not 5 V tolerant)
GI	digital input (GPIO); 3.3 V level (5 V tolerant)
GIO	digital input/output (GPIO); 3.3 V level (5 V tolerant)
GO	digital output (GPIO); 3.3 V level (5 V tolerant)
I	JTAG test input
IO2	digital input and output of the I ² C-bus interface; 3.3 V and 5 V compatible, auto-adapting

Table 10: Characteristics of pin types and remarks...continued

Pin type	Description
O	JTAG test output
O/D	open-drain output (for PCI-bus); multiple clients can drive LOW at the same time, wired-OR, floating back to 3-state over several clock cycles
PI	input according to PCI-bus requirements
PIO	input and output according to PCI-bus requirements
PO	output according to PCI-bus requirements
S/T/S	sustained 3-state (for PCI-bus); previous owner drives HIGH for one clock cycle before leaving to 3-state
T/S	3-state I/O (for PCI-bus); bi-directional
VG	ground for digital supply
VS	supply voltage (3.3 V)
Name ends with _N or #	this pin or 'signal' is active LOW, i.e. the function is 'true' if the logic level is LOW

6. Functional description

6.1 Overview of internal functions

The SAA7134HL is able to capture TV signals over the PCI-bus in personal computers by a single chip; see [Figure 4](#).

The SAA7134HL incorporates two 9-bit video ADCs and the entire decoding circuitry of any analog TV signal: NTSC, PAL and SECAM, including non-standard signals, such as playback from a VCR. The adaptive multi-line comb filter provides superb picture quality, component separation, sharpness and high bandwidth. The video stream can be cropped and scaled to the needs of the application. Scaling down as well as zooming up is supported in the horizontal and vertical direction, and an adaptive filter algorithm prevents aliasing artifacts. With the acquisition unit of the scaler two different 'tasks' can be defined, e.g. to capture video to the CPU for compression, and write video to the screen from the same video source but with different resolution, color format and frame rate.

The SAA7134HL contains TV sound stereo decoding from Sound IF (SIF), for NICAM standards and dual carrier FM systems, as used in European and Asian countries. Baseband stereo audio sampling is also implemented, e.g. for capturing from a camcorder or externally decoded BTSC. The audio sampling rate can be locked to the video frame rate to ensure synchronization (lip-sync) between the video and audio data flow, e.g. for storage, compression or time shift viewing applications.

The SAA7134HL incorporates analog audio pass-through and support for the analog audio loop back cable to the sound card function.

The decoded video streams are fed to the PCI-bus, and are also applied to a peripheral streaming interface, in ITU, VIP or VMI format. A possible application extension is on-board hardware MPEG compression, or other feature processing. The compressed data is fed back through the peripheral interface, in parallel or serial format, to be captured by the system memory through the PCI-bus. The Transport Stream (TS) from a DTV/DVB channel decoder can be captured through the peripheral interface in the same way.

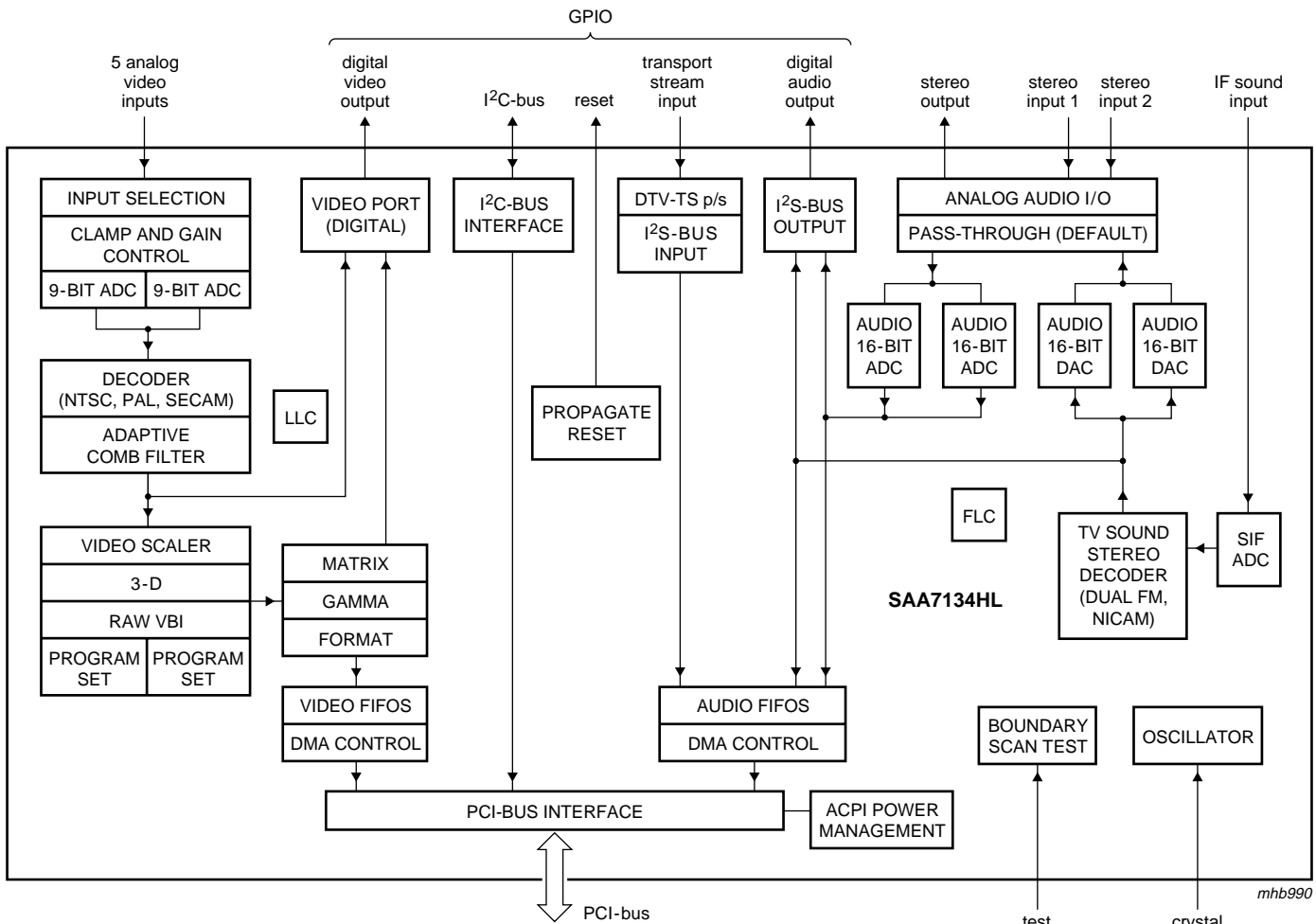

Fig 4. Functional diagram

Audio, video and transport streams are collected in a configurable FIFO with a total capacity of 1 kB. The DMA controller monitors the FIFO filling degree and master-writes the audio and video stream to the associated DMA channel. The virtual memory address space (from OS) is translated into physical (bus) addresses by the on-chip hardware Memory Management Unit (MMU).

The application of the SAA7134HL is supported by reference designs and a set of drivers for the Windows operating system (Windows driver model compliant).

6.2 Application examples

The SAA7134HL enables PC TV capture applications both on the PC motherboard and on PCI add-on TV capture cards. [Figure 5](#) and [Figure 6](#) illustrate some examples of add-on card applications.

[Figure 5](#) shows the basic application to capture video from analog TV sources. The proposed tuner types incorporate the RF tuning function and the IF downconversion. Usually the IF downconversion stage also includes a single channel and analog sound FM demodulator. The Philips tuner FI1216MK2 is dedicated to the 50 Hz system B/G standard as used in Europe. The FI1236MK2 is the comparable type for the 60 Hz system M standard for the USA. Both types are suited for terrestrial broadcast and for cable reception. The tuner provides composite video and baseband audio as mono or 'multiplexed' (mpx) in case of BTSC. These analog video and sound signals are fed to the appropriate input pins of the SAA7134HL.

Further analog video input signals, CVBS and/or Y-C, can be connected via the board back-panel, or the separate front connectors, e.g. from a camcorder. Accompanying stereo audio signals can also be fed to the SAA7134HL.

Video is digitized and decoded to YUV. TV sound is digitized and decoded to stereo audio, according to NICAM or dual FM standards. The digital streams are pumped via DMA into the PCI memory space.

The SAA7134HL incorporates means for legacy analog audio signal routing. The on-chip audio DACs convert the digital decoded stereo signal into analog audio. This analog audio input signal is fed via an analog audio loop back cable into the line-in of a legacy sound card. An external audio signal, that would have otherwise connected directly to the sound card, is now routed through the SAA7134HL. This analog pass-through is enabled as default by a system reset, i.e. without any driver involvement and before system setup.

During the power-up procedure, the SAA7134HL will investigate the on-board EEPROM to load the board specific system vendor ID and board version ID into the related places of the PCI configuration space. The board vendor can store other board specific data in the EEPROM that is accessible via the I²C-bus.

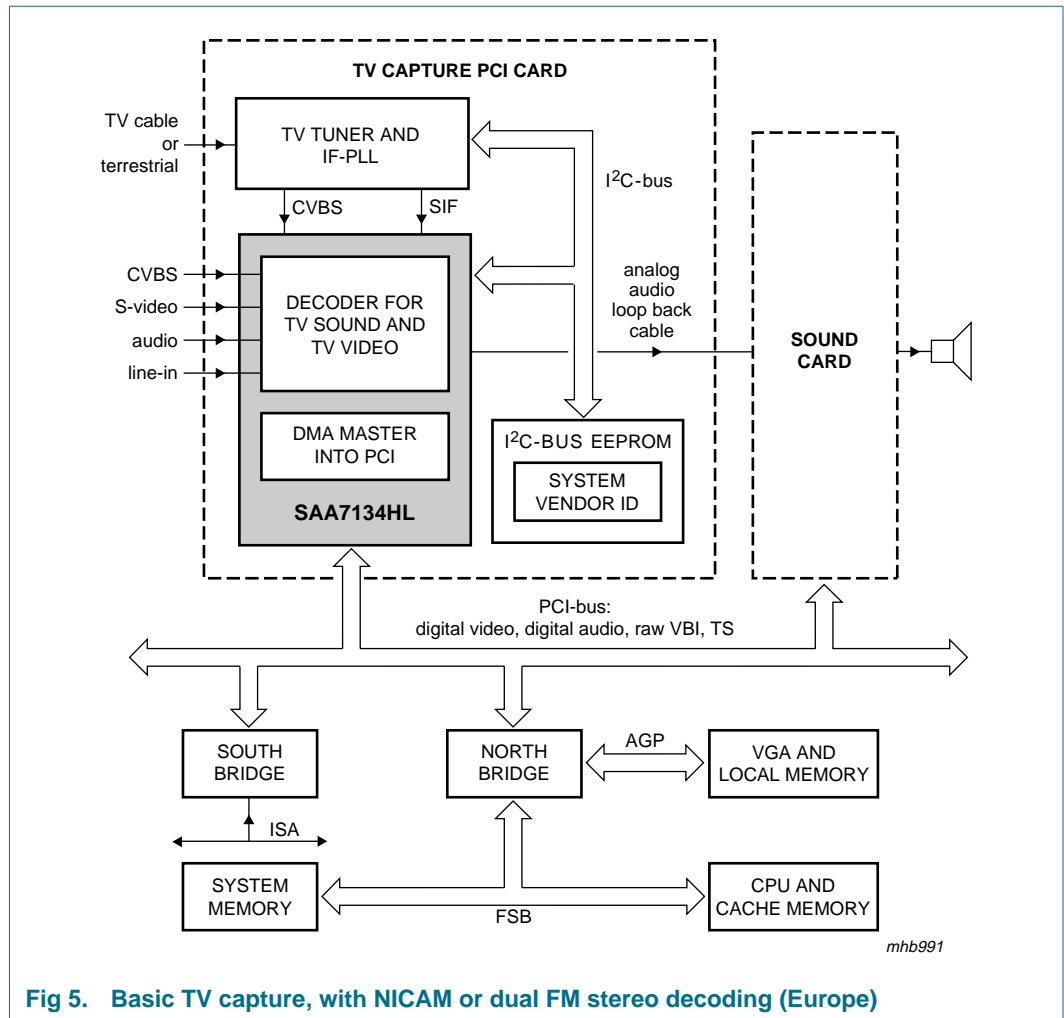

Fig 5. Basic TV capture, with NICAM or dual FM stereo decoding (Europe)

Figure 6 shows an application extension with a hybrid TV tuner front-end and digital terrestrial channel decoding for DTV-T.

The single-conversion tuner TD1316 provides two dedicated IF signals for the analog IF-PLL (TDA9886) and the digital IF-PLL (TDA9889). The CVBS (video) and SIF (sound) output signals of the analog IF-PLL can be routed to one of the video inputs and the SIF input of the SAA7134HL for analog TV decoding. On the other hand, the 2nd IF signal of the digital IF-PLL is fed directly to the interface of the channel decoder (TDA10045), which decodes the signal into a digital DVB-T Transport Stream (TS).

The SAA7134HL captures this TS via the dedicated peripheral interface into the configurable internal FIFO for DMA into the PCI memory space.

The packet structure as decoded by the TDA10045 is maintained in a well-defined buffer structure in the system memory, and therefore can easily be sorted (de-multiplexed) by the CPU for proper MPEG decoding.

The Broadcast Driver Architecture (BDA) for Windows operating systems supports this type of hybrid TV capture application, sharing one capture board for analog and digital TV reception.

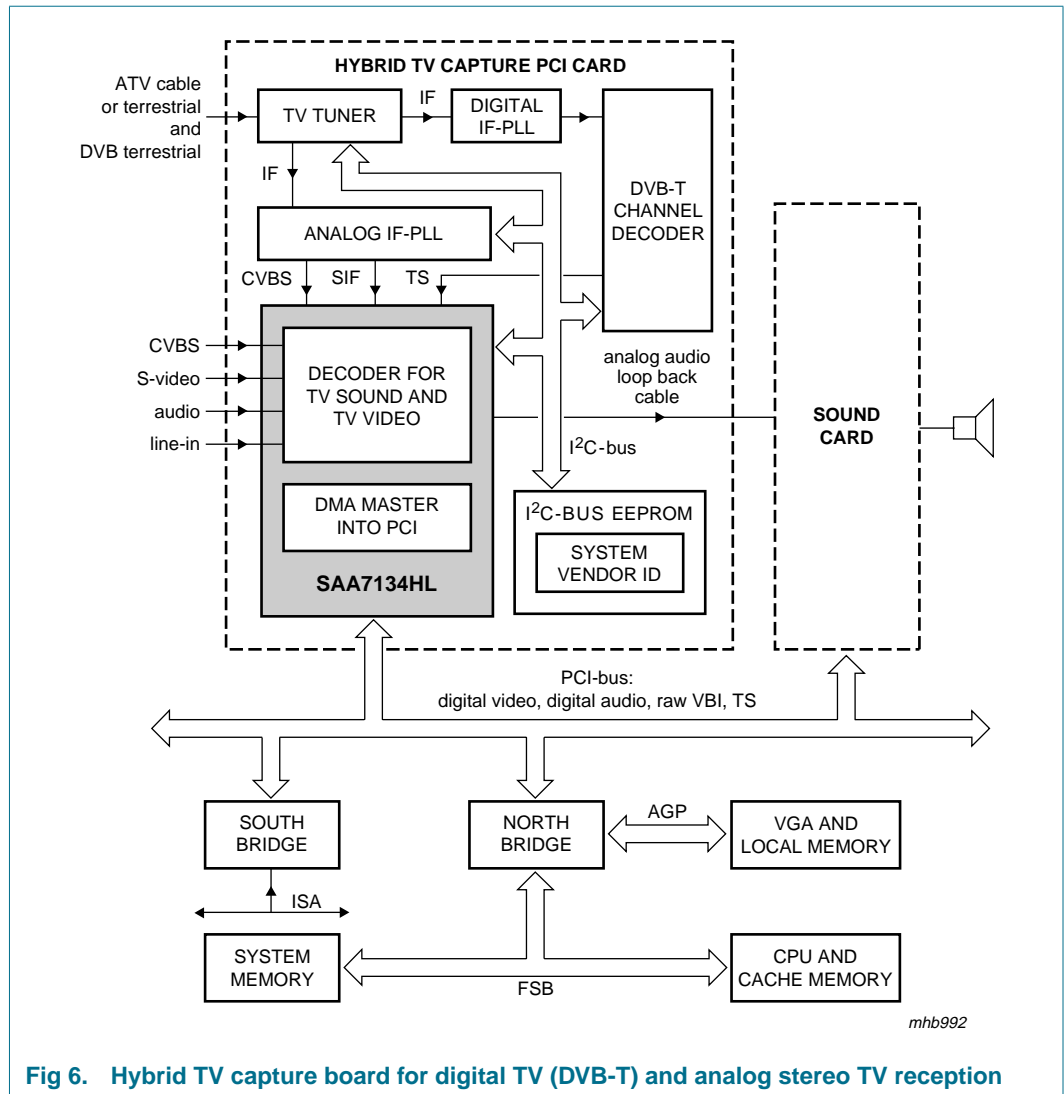

Fig 6. Hybrid TV capture board for digital TV (DVB-T) and analog stereo TV reception

6.3 Software support

6.3.1 Device driver

A complex and powerful software packet is provided for all PCI chips from the SAA713x family. This packet includes plug-and-play driver and capture driver installations for all commonly used 32-bit Windows platforms.

All platform related drivers support the following:

- Video preview and capture interfaces
- Audio control and audio capture interfaces.

Table 11: Microsoft Operation System (MOS) support

MOS	Driver support
Windows 98	Device access is contained with a kernel-mode Windows Driver Model (WDM) driver. The capture driver interface is based on Microsoft DirectShow technology.
Windows 2000	The driver is binary-compatible with the Windows 98 driver and validated for passing the Microsoft WHQL test for getting the Win2000 driver signature.
Windows XP	The driver is binary-compatible with the Windows 98 driver and validated for passing the Microsoft WHQL test for getting the WinXP driver signature.

6.3.2 Supporting WDM

The Windows driver is implemented as an AV-streaming class-driver and provides a 'DirectShow' (DS) filter with output pins for video preview, video capture and VBI, together with a crossbar for input sources selection.

The TV tuner filter is a separate child driver and supports the control of all common Philips CAN and Silicon tuners. The typical filter structure is shown in [Figure 7](#).

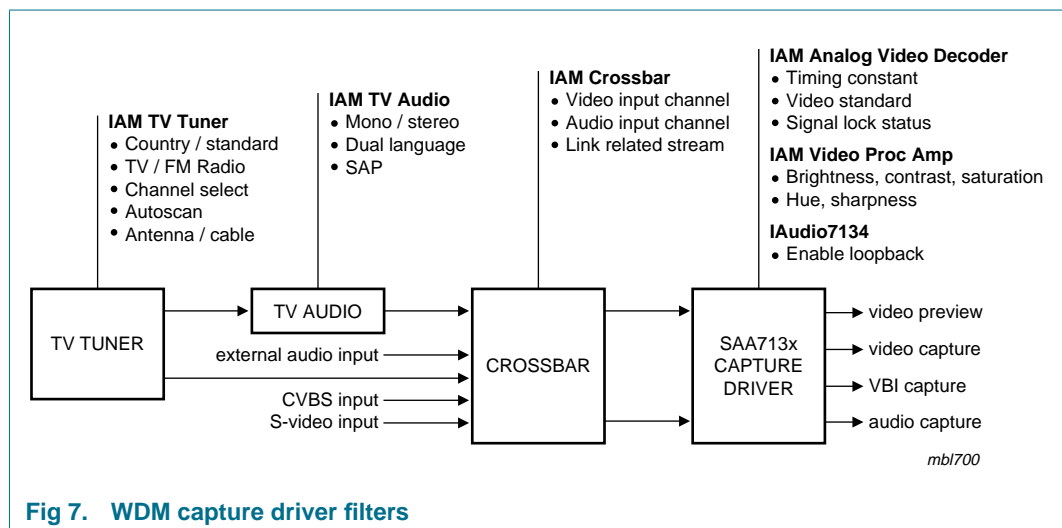

Fig 7. WDM capture driver filters

6.4 PCI interface

6.4.1 PCI configuration registers

The PCI interface of the SAA7134HL complies with the *PCI specification 2.2* and supports power management and Advanced Configuration and Power Interface (ACPI) as required by the *PC Design Guide 2001*.

The PCI specification defines a structure of the PCI configuration space that is investigated during the boot-up of the system. The configuration registers (see [Table 12](#)) hold information essential for plug-and-play, to allow system enumeration and basic device setup without depending on the device driver, and support association of the proper software driver. Some of the configuration information is hard-wired in the device; some information is loaded during the system start-up.

Table 12: PCI configuration registers

Function	Register address (hex)	Value ^[1]	Remark
Device vendor ID	00 and 01	1131h	for Philips
Device ID	02 and 03	7134h	for SAA7134HL
Revision ID	08	00h	or higher
Class code	09 to 0B	04 8000h	multimedia
Memory address space required	10 to 13	XXXX XXXX XXXX XXXX XXXX XX00 0000 0000b	1 kB
System (board) vendor ID	2C and 2D	loaded from EEPROM	
Sub-system (board version) ID	2E and 2F	loaded from EEPROM	

[1] X = don't care.

The device vendor ID is hard coded to 1131h, which is the code for Philips as registered with PCI-SIG.

The device ID is hard coded to 7134h.

During power-up, initiated by PCI reset, the SAA7134HL fetches additional system information via the I²C-bus from the on-board EEPROM, to load actual board type specific codes for the system vendor ID, sub-system ID (board version) and ACPI related parameters into the configuration registers.

6.4.2 ACPI and power states

The *PCI specification 2.2* requires support of *Advanced Configuration and Power Interface specification 1.0* (ACPI); more details are defined in the *PCI Power Management Specification 1.0*.

The power management capabilities and power states are reported in the extended configuration space. The main purpose of ACPI and PCI power management is to tailor the power consumption of the device to the actual needs.

The SAA7134HL supports all four ACPI device power states (see [Table 13](#)).

The pin PROP_RST_N of the peripheral interface is switched active LOW during the PCI reset procedure, and for the duration of the D3-hot state. Peripheral devices on board of the add-on card should use the level of this signal PROP_RST_N to switch themselves in any Power-save mode (e.g. disable device) and reset to default settings on the rising edge of signal PROP_RST_N.

Table 13: Power management table

Power state	Description
D0	Normal operation: all functions accessible and programmable. The default setting after reset and before driver interaction (D0 un-initialized) switches most of the circuitry of the SAA7134HL into the Power-down mode, effectively such as D3-hot.
D1	First step of reduced power consumption: no functional operation. Program registers are not accessible, but content is maintained. Most of the circuitry of the SAA7134HL is disabled with exception of the crystal and real-time clock oscillators, so that a quick recovery from D1 to D0 is possible.
D2	Second step of reduced power consumption: no functional operation. Program registers are not accessible, but content is maintained. All functional circuitry of the SAA7134HL is disabled, including the crystal and clock oscillators.
D3-hot	Lowest power consumption: no functional operation. The content of the programming registers gets lost and is set to default values when returning to D0.

6.4.3 DMA and configurable FIFO

The SAA7134HL supports seven DMA channels to master-write captured active video, audio, raw VBI and DTV/DVB Transport Streams (TS) into the PCI memory. Each DMA channel contains inherently the definition of two buffers, e.g. for odd and even fields in case of interlaced video, or two alternating buffers to capture continuous audio stream.

The DMA channels share in time and space one common FIFO pool of 256 Dwords (1024 bytes) total. It is freely configurable how much FIFO capacity can be associated with which DMA channel. Furthermore, a preferred minimum burst length can be programmed, i.e. the amount of data to be collected before the request for the PCI-bus is issued. This means that latency behavior per DMA channel can be tailored and optimized for a given application.

In the event that a FIFO of a certain channel overflows due to latency conflict on the bus, graceful overflow recovery is applied. The amount of data that gets lost because it could not be transmitted, is monitored (counted) and the PCI-bus address pointer is incremented accordingly. Thus new data will be written to the correct memory place, after the latency conflict is resolved.

6.4.4 Virtual and physical addressing

Most operating systems allocate memory to requesting applications for DMA as continuous ranges in virtual address space. The data flow over the PCI-bus points to physical addresses, usually not continuous and split in pages of 4 kB (Intel architecture, most UNIX systems, Power PC).

The association between the virtual (logic) address space and the fragmented physical address space is defined in page tables (system files); see [Figure 8](#).

The SAA7134HL incorporates hardware support (MMU) to translate virtual to physical addresses on the fly, by investigating the related page table information. This hardware support reduces the demand for real-time software interaction and interrupt requests, and therefore saves system resources.

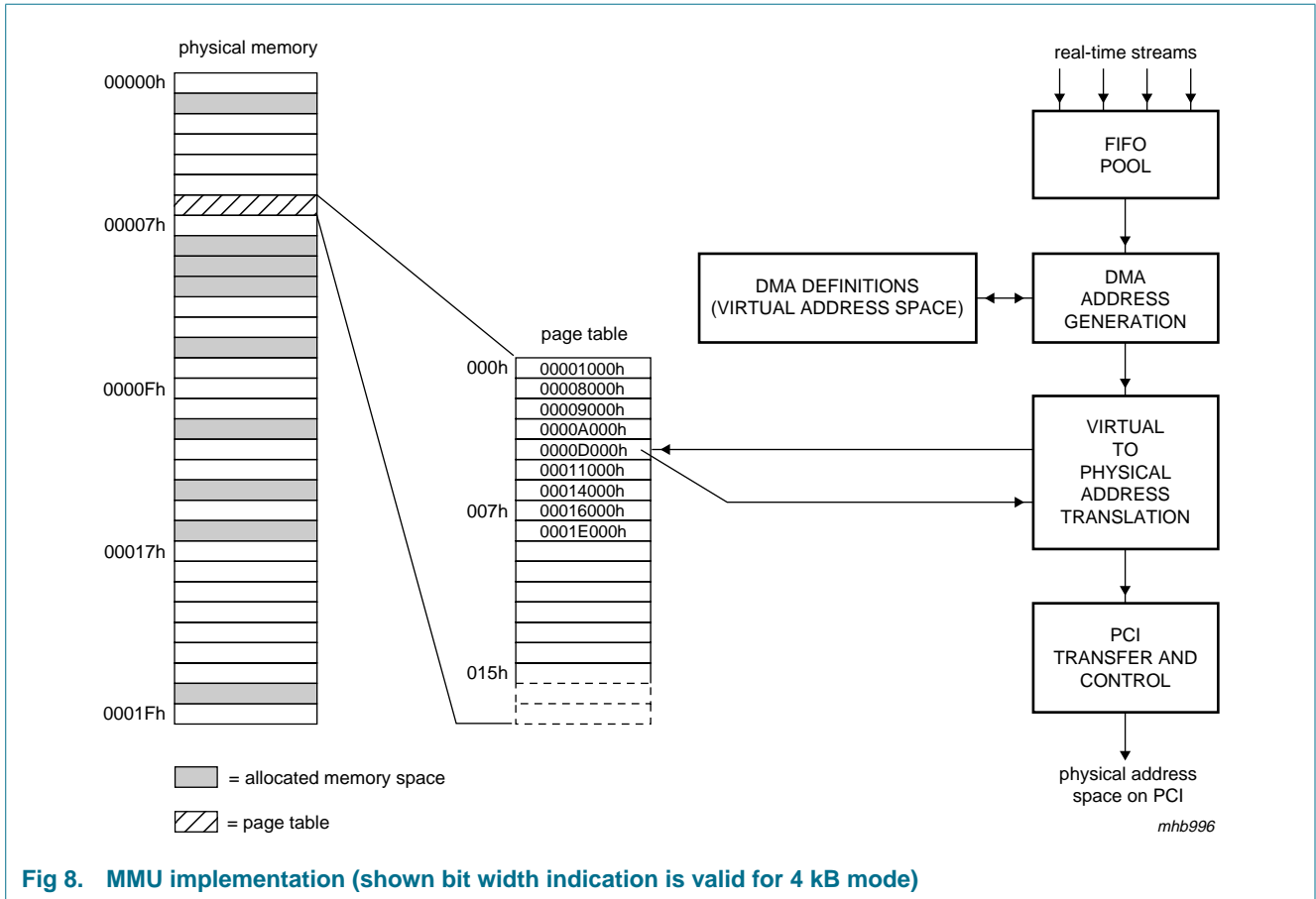

Fig 8. MMU implementation (shown bit width indication is valid for 4 kB mode)

6.4.5 Status and interrupts on PCI-bus

The SAA7134HL provides a set of status information about internal signal processing, video and audio standard detection, peripheral inputs and outputs (pins GPIO) and behavior on the PCI-bus. This status information can be conditionally enabled to raise an interrupt on the PCI-bus, e.g. completion of a certain DMA channel or buffer, or change in a detected TV standard, or the state of peripheral devices.

The cause of an issued interrupt is reported in a dedicated register, even if the original condition has changed before the system was able to investigate the interrupt.

6.5 Analog TV standards

Analog TV signals are described in three categories of standards:

- Basic TV systems: defining frame rate, number of lines per field, levels of synchronization signals, blanking, black and white, signal bandwidth and the RF modulation scheme
- Color transmission: defining color coding and modulation method
- Sound and stereo: defining coding for transmission

TV signals that are broadcast usually conform fairly accurately to the standards. Transmission over the air or through a cable can distort the signal with noise, echoes, crosstalk or other disturbances.

Video signals from local consumer equipment, e.g. VCR, camcorder, camera, game console, or even DVD player, often do not follow the standard specification very accurately.

Playback from video tape cannot be expected to maintain correct timing, especially not during feature mode (fast forward, etc.).

[Table 14](#) to [Table 16](#) list some characteristics of the various TV standards.

The SAA7134HL decodes all color TV standards and non-standard signals as generated by video tape recorders e.g. automatic video standard detection can be applied, with preference options for certain standards, or the decoder can be forced to a dedicated standard.

The SAA7134HL incorporates TV stereo decoding for NICAM and dual FM sound systems. BTSC and EIAJ are demodulated to monaural sound, but stereo decoding can be added externally. Baseband stereo audio can be fed into the device as analog signal, or in digital form in I²S-bus format.

Table 14: Overview of basic TV standards

Main parameters	Standard							Unit
	M	N	B	G, H	I	D/K	L	
RF channel width	6	6	7	7	8	7	8	MHz
Video bandwidth	4.2	4.2	5	5	5.5	6	6	MHz
1st sound carrier	4.5, FM	4.5, FM	5.5, FM	5.5, FM	6.0, FM	6.5, FM	6.5, AM	MHz
Field rate	59.94006	50	50	50	50	50	50	Hz
Lines per frame	525	625	625	625	625	625	625	-
Line frequency	15.734	15.625	15.625	15.625	15.625	15.625	15.625	kHz
ITU clocks per line	1716	1728	1728	1728	1728	1728	1728	-
Sync, setup level	-40, 7.5	-40, 7.5	-43, 0	-43, 0	-43, 0	-43, 0	-43, 0	IRE
Gamma correction	2.2	2.2	2.8	2.8	2.8	2.8	2.8	-

Table 14: Overview of basic TV standards...continued

Main parameters	Standard							Unit
	M	N	B	G, H	I	D/K	L	
Associated color TV standards	NTSC, PAL	PAL	PAL	PAL	PAL	SECAM, PAL	SECAM	-
Associated stereo TV sound systems	BTSC, EIAJ, A2	BTSC	dual FM, A2	NICAM	NICAM	NICAM, A2	NICAM	-
Country examples	USA, Japan, Brazil	Argentina	part of Europe, Australia	Spain, Malaysia, Singapore	UK, Northern Europe	China, Eastern Europe	France, Eastern Europe	-

Table 15: TV system color standards

Main parameters	NTSC M	PAL M	PAL N	PAL BGHID	SECAM LDGHK	PAL 4.4 (60 Hz)	Unit
Field rate	59.94	59.94	50	50	50	≈60	Hz
Lines per frame	525	525	625	625	625	525	
Chrominance subcarrier	3.580	3.576	3.582	4.434	4.406	4.250	MHz
f_{sc} to H ratio	227.5	227.25	229.25	283.75	282	272	n.a.
f_{sc} offset (PAL)	-	-	50	50	-	-	n.a. Hz
Alternating phase	no	yes	yes	yes	-	-	yes
Country examples	USA, Japan, Asia-Pacific	Brazil	Middle and South America	Europe, Commonwealth, China	France, Eastern Europe, Africa, Middle East	VCR transcoding NTSC-tape to PAL	

Table 16: TV stereo sound standards

Main parameters	Analog systems				Digital coding			Unit
	Mono	BTSC	EIAJ	A2 (dual FM)	NICAM			
Stereo coding scheme	-	internal carrier (mpx) AM	FM	2-Carrier Systems (2CS) 2nd FM carrier	DQPSK on FM			
2nd language	-	mono SAP on internal FM	as alternative to stereo	as alternative to stereo	mono on 1st carrier			
Sound IF				1st	2nd	1st	2nd	
M, N	4.5 FM	4.5	4.5	4.5	4.724	not used	not used	MHz
B, G, H	5.5 FM	not used	not used	5.5	5.742	5.5	5.850	MHz
I	6.0 FM	not used	not used	not used	not used	6.0	6.552	MHz
DK (1)	6.5 FM	not used	not used	6.5	6.742	6.5	5.850	MHz
DK (2)	6.5 FM	-	-	-	6.258	-	-	MHz
DK (3)	6.5 FM	-	-	-	5.742	-	-	MHz
L	6.5 AM	not used	not used	not used	not used	6.5	5.850	MHz
De-emphasis	75	75, dbx-TV	50	50 or 75	50 or 75	50 or 75	50 or 75	μs
Audio bandwidth	15	15	15	15	15	15	15	kHz
Country examples	world-wide	USA, South America	Japan	part of Europe, Korea	part of Europe, China			

6.6 Video processing

6.6.1 Analog video inputs

The SAA7134HL provides five analog video input pins:

- Composite video signals (CVBS), from tuner or external source
- S-video signals (pairs of Y-C), e.g. from camcorder
- DTV/DVB 'low-IF' signal, from an appropriate DTV or combi-tuner

Analog anti-alias filters are integrated on chip and therefore, no external filters are required. The device also contains automatic clamp and gain control for the video input signals, to ensure optimum utilization of the ADC conversion range. The nominal video signal amplitude is 1 V (p-p) and the gain control can adapt deviating signal levels in the range of +3 dB to -6 dB. The video inputs are digitized by two ADCs of 9-bit resolution, with a sampling rate of nominal 27 MHz (the line-locked clock) for analog video signals.

6.6.2 Video synchronization and line-locked clock

The SAA7134HL recovers horizontal and vertical synchronization signals from the selected video input signal, even under extremely adverse conditions and signal distortions. Such distortions are 'noise', static or dynamic echoes from broadcast over air, crosstalk from neighboring channels or power lines (hum), cable reflections, time base errors from video tape play-back and non-standard signal levels from consumer type video equipment (e.g. cameras, DVD).

The heart of this TV synchronization system is the generation of the Line-Locked Clock (LLC) of nominal 27 MHz, as defined by *ITU-R BT.601*. The LLC ensures orthogonal sampling, and always provides a regular pattern of synchronization signals, that is a fixed and well defined number of clock pulses per line. This is important for further video processing devices connected to the peripheral video port (pins GPIO). It is very effective to run under the LLC of 27 MHz, especially for on-board hardware MPEG encoding devices, since MPEG is defined on this clock and sampling frequency.

6.6.3 Video decoding and automatic standard detection

The SAA7134HL incorporates color decoding for any analog TV signal. All color TV standards and flavors of NTSC, PAL, SECAM and non-standard signals (VCR) are automatically recognized and decoded into luminance and chrominance components, i.e. $Y-C_B-C_R$, also known as YUV.

The video decoder of the SAA7134HL incorporates an automatic standard detection, that does not only distinguish between 50 Hz and 60 Hz systems, but also determines the color standard of the video input signal. Various preferences ('look first') for automatic standard detection can be chosen, or a selected standard can be forced directly.

6.6.4 Adaptive comb filter

The SAA7134HL applies adaptive comb filter techniques to improve the separation of luminance and chrominance components in comparison to the separation by a chroma notch filter, as used in traditional TV color decoder technology. The comb filter compares the signals of neighboring lines, taking into account the phase shift of the chroma subcarrier from line to line. For NTSC the signal from three adjacent lines are investigated, and in the event of PAL the comb filter taps are spread over four lines.

Comb filtering achieves higher luminance bandwidth, resulting in sharper picture and detailed resolution. Comb filtering further minimizes color crosstalk artifacts, which would otherwise produce erroneous colors on detailed luminance structures.

The comb filter as implemented in the SAA7134HL is adaptive in two ways:

- Adaptive to transitions in the picture content
- Adaptive to non-standard signals (e.g. VCR)

The integrated digital delay lines are always exactly correct, due to the applied unique line-locked sampling scheme (LLC). Therefore the comb filter does not need to be switched off for non-standard signals and remains operating continuously.

6.6.5 Macrovision detection

The SAA7134HL detects if the decoded video signal is copy protected by the Macrovision system. The detection logic distinguishes the three levels of the copy protection as defined in rev. 7.01, and are reported as status information. The decoded video stream is not effected directly, but application software and Operation System (OS) has to ensure that this video stream maintains tagged as 'copy protected', and such video signal would leave the system only with the reinforced copy protection. The multi-level Macrovision detection on the video capture side supports proper TV re-encoding on the output point, e.g. by Philips TV encoders SAA712x or SAA7102.

6.6.6 Video scaling

The SAA7134HL incorporates a filter and processing unit to downscale or upscale the video picture in the horizontal and vertical dimension, and in frame rate (see [Figure 9](#) and [Figure 10](#)). The phase accuracy of the re-sampling process is $\frac{1}{64}$ of the original sample distance. This is equivalent to a clock jitter of less than 1 ns. The filter depth of the anti-alias filter adapts to the scaling ratio, from 10 taps horizontally for scaling ratios close to 1 : 1, to up to 74 taps for an icon sized video picture.

Most video capture applications will typically require for downscaling. But some zooming is required for conversion of ITU sampling to SQuare Pixel (SQP), or to convert the 240 lines of an NTSC field to 288 lines to comply with ITU-T video phone formats.

The scaling acquisition definition also includes cropping, frame rate reduction, and defines the amount of pixels and lines to be transported through DMA over the PCI-bus.

Two programming pages are available to enable re-programming of the scaler in the 'shadow' of the running processing, without holding or disturbing the flow of the video stream. Alternatively, the two programming pages can be applied to support two video destinations or applications with different scaler settings, e.g. firstly to capture video to CPU for compression (storage, video phone), and secondly to preview the picture on the monitor screen. A separate scaling region is dedicated to capture raw VBI samples, with a specific sampling rate, and be written into its own DMA channel.

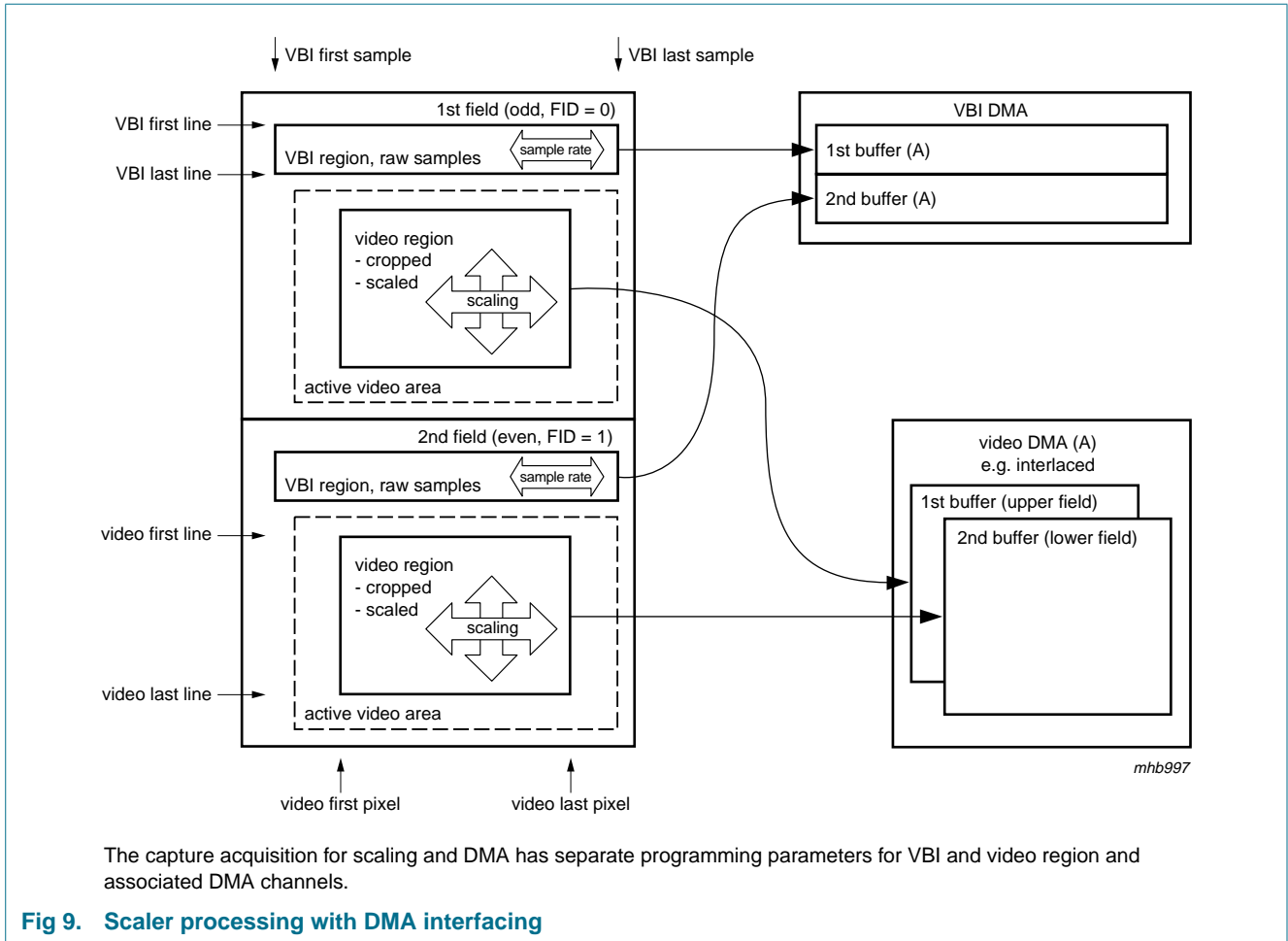

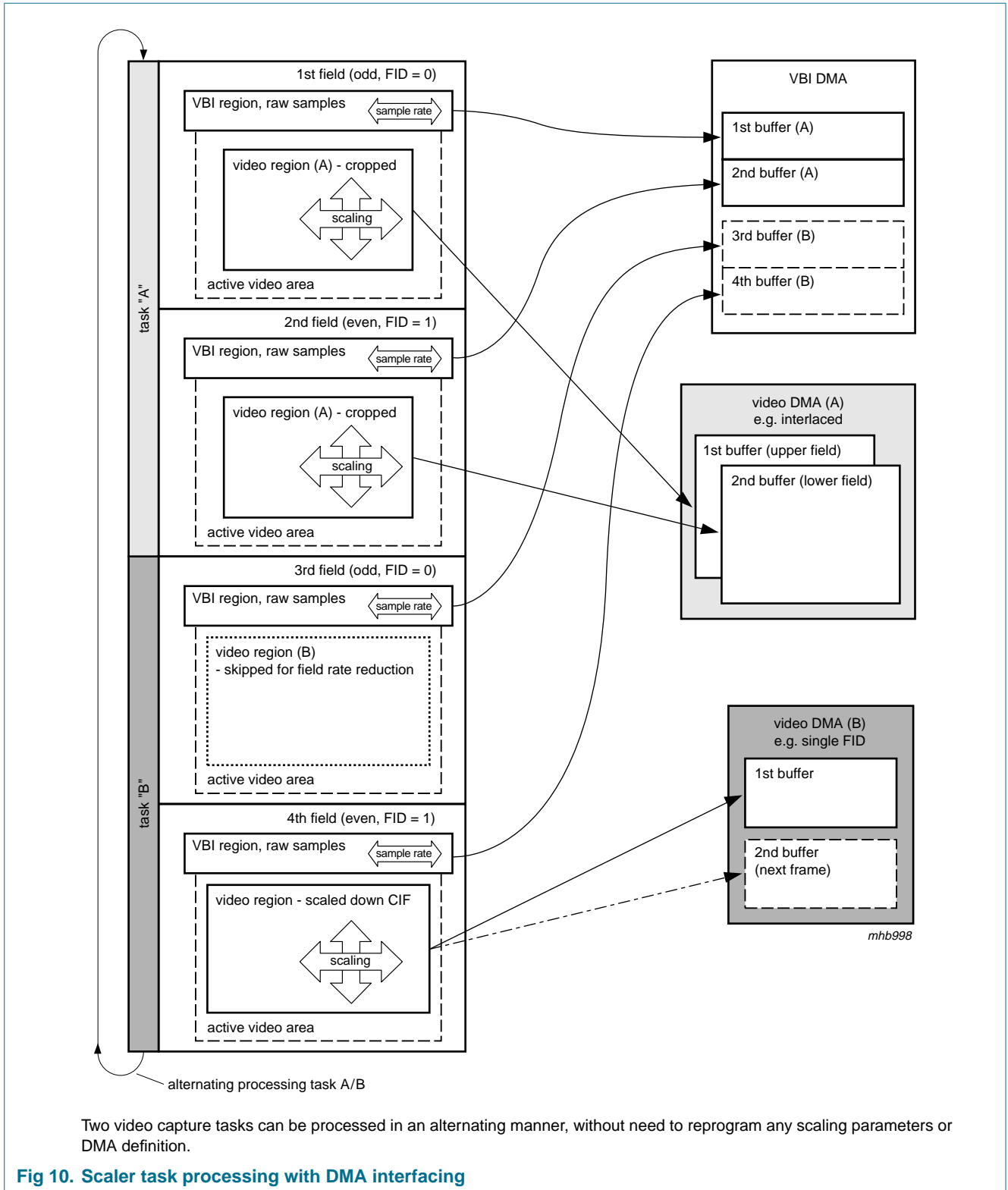

6.6.7 VBI data

The Vertical Blanking Interval (VBI) is often utilized to transport data over analog video broadcast. Such data can closely relate to the actual video stream, or just be general data (e.g. news). Some examples for VBI data types are:

- Closed Caption (CC) for the hearing impaired (CC, on line 21 of first field)
- Intercast data in US coded in North-American Broadcast Text System (NABTS) format, in Europe in World Standard Teletext (WST), to transmit internet related services, optionally associated with actual video program content
- Teletext, transporting news services and broadcast related information, Electronic Program Guide (EPG), widely used in Europe (coded in WST format)
- EPG, broadcaster specific program and schedule information, sometimes with proprietary coding scheme (pay service), usually carried on NABTS, WST, Video Programming Service (VPS), or proprietary data coding format
- Video Time Codes (VTC) as inserted in camcorders e.g. use for video editing
- Copy Guard Management System (CGMS) codes, to indicate copy protected video material, sometimes combined with format information, Wide Screen Signalling (WSS)

This information is coded in the unused lines of the vertical blanking interval, between the vertical sync pulse and the active visible video picture. So-called full-field data transmission is also possible, utilizing all video lines for data coding.

The SAA7134HL supports capture of VBI data by the definition of a VBI region to be captured as raw VBI samples, that will be sliced and decoded by software on the host CPU. The raw sample stream is taken directly from the ADC and is not processed or filtered by the video decoder. The sampling rate of raw VBI can be adjusted to the needs of the data slicing software.

6.6.8 Signal levels and color space

Analog TV video signals are decoded into its components luminance and color difference signals (YUV) or in its digital form $Y-C_B-C_R$. *ITU-R BT.601* defines 720 pixels along the line (corresponding to a sampling rate of 27 MHz divided by two), and a certain relationship from level to number range; see [Figure 11](#).

The video components do not use the entire number range, but leave some margin for overshoots and intermediate values during processing. For the raw VBI samples there is no official specification how to code, but it is common practice to reserve the lower quarter of the number range for the sync, and to leave some room for overmodulation beyond the nominal white amplitude; see [Table 12](#).

The automatic clamp and gain control at the video input, together with the automatic chroma gain control of the SAA7134HL, ensures that the video components stream at the output comply to the standard levels. Beyond that additional brightness, contrast, saturation and hue control can be applied to satisfy special needs of a given application. The raw VBI samples can be adjusted independent of the active video.

The SAA7134HL incorporates the YUV-to-RGB matrix (optional), the RGB-to-YUV matrix and a three channel look-up table in between; see [Figure 13](#). Under nominal settings, the RGB space will use the same number range as defined by the ITU and shown in [Figure 11](#) for luminance, between 16 and 235. As graphic related applications are based

on full-scale RGB, i.e. 0 to 255, the range can be stretched by applying appropriate brightness, contrast and saturation values. The look-up table supports gamma correction (freely definable), and allows other non-linear signal transformation such as black stretching.

The analog TV signal applies a quite strong gamma pre-compensation (2.2 for NTSC and 2.8 for PAL). As computer monitors exhibit a gamma (around 2.5), the difference between gamma pre-compensation and actual screen gamma has to be corrected, to achieve best contrast and color impression.

The SAA7134HL offers a multitude of formats to write video streams over the PCI-bus: YUV and RGB color space, 15-bit, 16-bit, 24-bit and 32-bit representation, packed and planar formats. For legacy requirements a clipping procedure is implemented, that allows the definition of eight overlay rectangles. This process can alternatively be used to associate 'alpha' values to the video pixels.

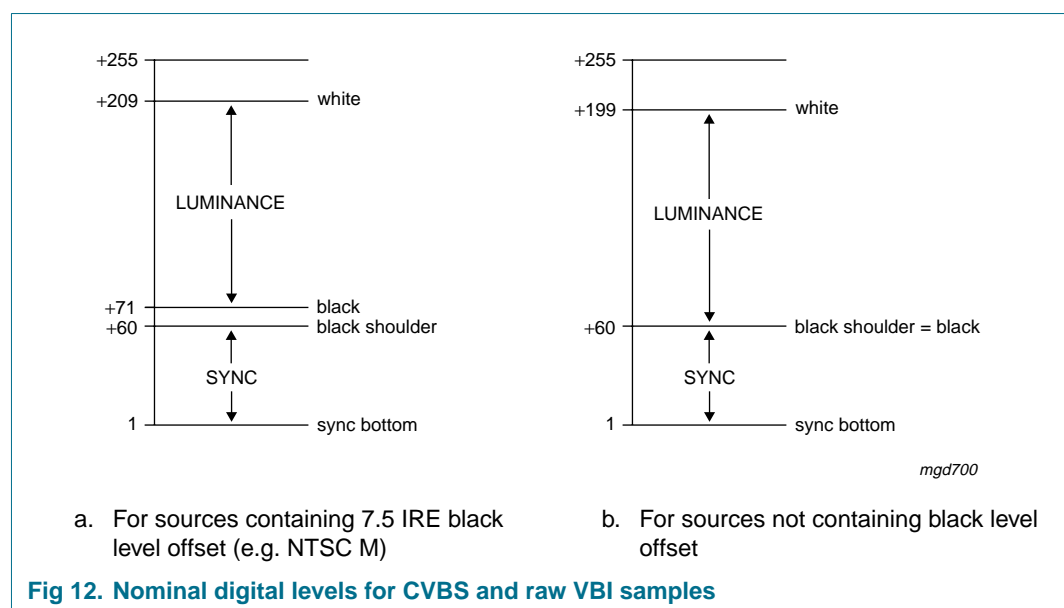
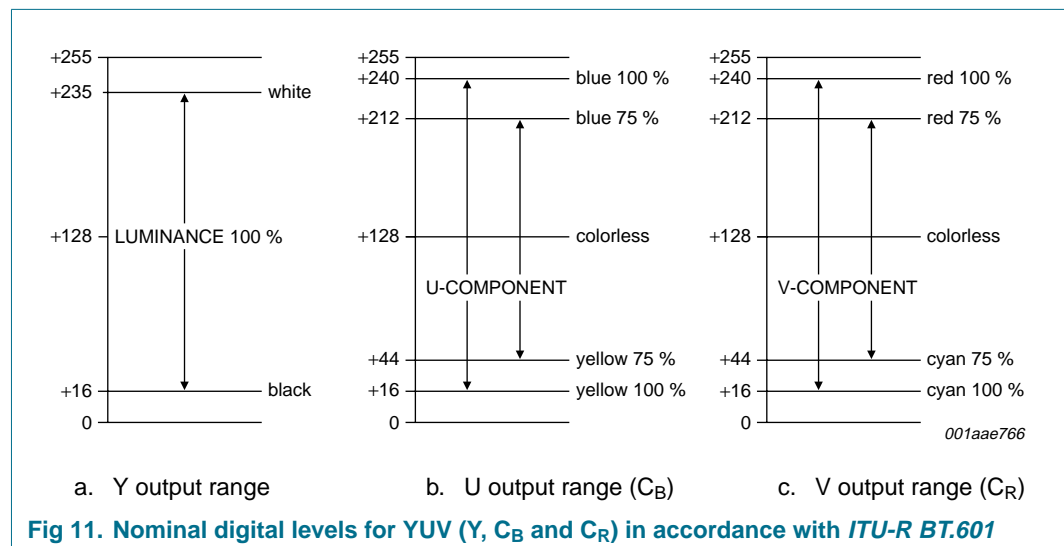

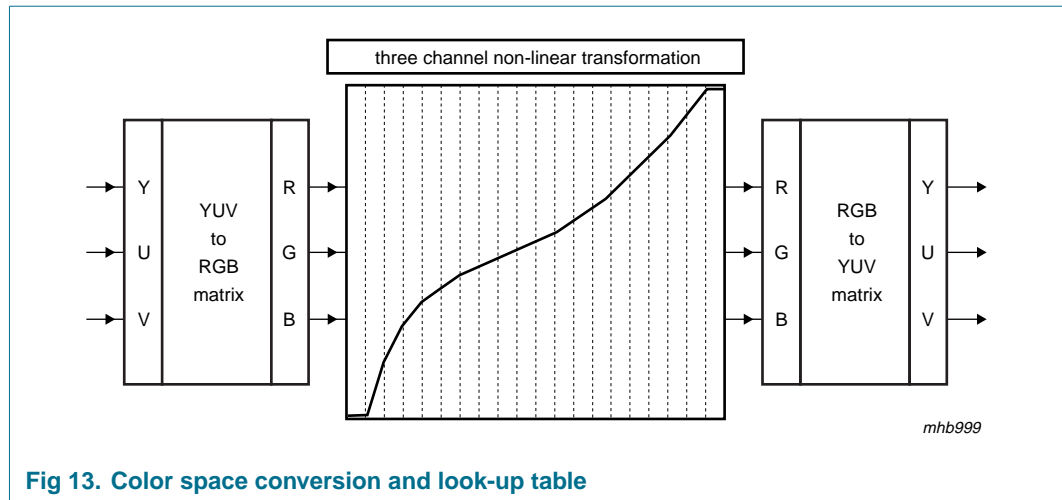

Fig 13. Color space conversion and look-up table

6.6.9 Video port, ITU and VIP codes

The decoded and/or scaled video stream can be captured via PCI-DMA to the system memory, and/or can be made available locally through the video side port (VP), using some of the GPIO pins. Two types of applications are intended:

- Streaming real-time video to a video side port at the VGA card, e.g. via ribbon cable over the top
- Feeding video stream to a local MPEG compression device on the same PCI board, e.g. for time shift viewing applications

The video port of the SAA7134HL supports the following 8 and 16-bit wide YUV video signalling standards (see [Table 9](#)):

- VMI: 8-bit wide data stream, clocked by LLC = 27 MHz, with discrete sync signals HSYNC, VSYNC and VACTIVE
- *ITU-R BT.656*, parallel: 8-bit wide data stream, clocked by LLC = 27 MHz, synchronization coded in SAV and EAV codes
- VIP 1.1 and 2.0: 8-bit or 16-bit wide data stream, clocked by LLC = 27 MHz, synchronization coded in SAV and EAV codes (with VIP extensions)
- Zoom Video (ZV): 16-bit wide pixel stream, clocked by LLC/2 = 13.5 MHz, with discrete sync signals HSYNC and VSYNC
- *ITU-R BT.601* direct (DMSD): 16-bit wide pixel stream, clocked by LLC = 27 MHz, with discrete sync signals HSYNC, VSYNC/FID and CREF
- Raw DTV/DVB sample stream: 9-bit wide data, clocked with a copy of signal X_CLK_IN

The VIP standard can transport scaled video and discontinuous data stream by allowing the insertion of '00' as marker for empty clock cycles. For the other video port standards, a data valid flag or gated clock can be applied.

6.7 TV sound

6.7.1 TV sound stereo decoding

TV sound is modulated on an internal sound subcarrier, on the upper end of the TV RF channel, at 4.5 MHz, 5.5 MHz, 6.0 MHz, or 6.5 MHz, depending on the TV system. The modulation is usually on FM and for system L on AM (see [Table 16](#)). There are basically three variants how stereo sound is encoded on analog TV transmission:

- An internal multiplexed carrier for the difference signal L – R (BTSC uses AM and EIAJ uses FM); this is similar to FM radio stereo
- A second independent FM carrier in the RF channel (dual FM), that can carry the difference signal L – R, or a second language
- A (second) independent FM/QPSK carrier in the RF channel (NICAM), carrying a digital audio signal, stereo, or dual language mono

Some parameters of the used coding scheme are modulated on an inaudible pilot carrier.

The SAA7134HL incorporates TV sound decoding from the Sound Intermediate Frequency (SIF) signal. The analog SIF signal is taken from the tuner, digitized and digitally FM or AM demodulated. The pilot tone is investigated and the signal is properly stereo decoded. The SAA7134HL supports TV stereo decoding for all NICAM and dual FM sound systems on-chip. The digital FM demodulation maintains stable phase accuracy, resulting into improved channel separation, compared to traditional analog demodulation. BTSC and EIAJ are demodulated to monaural sound, but stereo decoding can be added externally.

The SAA7134HL incorporates baseband stereo audio ADCs, to capture sound signals associated with external video sources, e.g. camera, camcorder or VCR.

For concurrent capture of audio and video signals, it is important to maintain synchronization between the two streams. The spoken word and other sound should match the displayed picture within a video frame ($\frac{1}{30}$ s 'lip-sync'). The SAA7134HL has special means to lock the audio sampling clock to the video frame frequency (FLC), so that a certain fix predefined number of audio samples are associated with each video field. This is especially important for video editing, compression and recording, e.g. time shift viewing. There is no drift between the audio and video streams, not even for longer recording times.

TV sound offers an audio bandwidth of less than 15 kHz, that is usually sampled and digitized with 32 kHz. NICAM as digital sound coding has inherently a 32 kHz sample rate, locked already on the source side to the video rate. The digital audio stream can be captured through dedicated DMA into the PCI memory space, or to the output in I²S-format to further peripheral digital sound processing, e.g. virtual surround sound, or converted to analog stereo via integrated audio DACs, to feed analog audio over the loop back cable to the sound card function.

6.7.2 Analog audio pass-through and loop back cable

Most operating systems are prepared to deal with audio input at only one single entry point, namely at the sound card function. Therefore the sound associated with video has to get routed through the sound card.

The SAA7134HL supports analog audio pass-through and the loop back cable on-chip. No external components are required. The audio signal, that was otherwise connected to the sound card line-in, e.g. analog sound from a CD-ROM drive, has to be connected to one of the inputs of the SAA7134HL. By default, after a system reset and without involvement of any driver, this audio signal is passed through to the analog audio output pins, that will feed the loop back cable to the sound card line-in connector. The AV capture driver has to open the default pass-through and switch in the TV sound signal by will.

6.8 DTV/DVB channel decoding and TS capture

The SAA7134HL is optimally equipped to support the application extension to capture digital TV signals, e.g. for VSB (ATSC) or DVB (T/C/S). A hybrid TV tuner for analog and digital TV broadcast reception usually provides a DTV signal on low IF, i.e. downconverted into a frequency range from 0 MHz to 10 MHz. Such signals can be fed to one of the 5 video inputs of the SAA7134HL for digitizing. The digital raw DTV is output at the video port, and is sent to the peripheral channel decoder, e.g. TDA8961 for VSB-8 decoding. The channel decoder provides the sampling clock via the external clock input pin X_CLK_IN (up to 36 MHz input clock frequency), and adjusts the signal gain in the tuner or in the video input path in front of the ADC. Alternatively, the low IF DTV/DVB signal could be fed directly to the channel decoder, depending on the capability for digitizing the selected device.

The peripheral channel decoder circuitry decodes the digital transmission into bits and bytes, apply error correction etc. and outputs a packed Transport Stream (TS) accompanied by a clock and handshake signals. The SAA7134HL captures the TS in parallel or serial protocol, synchronized by Start Of Packet (SOP), and pumps it via the dedicated DMA into the PCI memory space. The DMA definition supports automatic toggling between two buffers.

6.9 Control of peripheral devices

6.9.1 I²C-bus master

The SAA7134HL incorporates an I²C-bus master to setup and control peripheral devices such as tuner, DTV/DVB channel decoder, audio DSP co-processors, etc. The I²C-bus interface itself is controlled from the PCI-bus on a command level, reading and writing byte by byte. The actual I²C-bus status is reported (status register) and, as an option, can raise error interrupts on the PCI-bus.

At PCI reset time, the I²C-bus master receives board specific information from the on-board EEPROM to update the PCI configuration registers.

The I²C-bus interface is multi-master capable and can assume slave operation too. This allows application of the device in the stand-alone mode, i.e. with the PCI-bus not connected. Under the slave mode, all internal programming registers can be reached via the I²C-bus with exception of the PCI configuration space.

6.9.2 Propagate reset

The PCI system reset and ACPI power management state D3 is propagated to peripheral devices by the dedicated pin PROP_RST_N. This signal is switched to active LOW by reset and D3, and is only switched HIGH under control of the device driver 'by will'. The intention is that peripheral devices will use signal PROP_RST_N as Chip-Enable (CE). The peripheral devices should enter a low power consumption state if pin PROP_RST_N = LOW, and reset into default setting at the rising edge.

6.9.3 GPIO

The SAA7134HL offers a set of General Purpose Input/Output (GPIO) pins, to interface to on-board peripheral circuits. These GPIOs are intended to take over dedicated functions:

- Digital video port output: 8-bit or 16-bit wide (including raw DTV)
- Digital audio serial output: i.e. I²S-bus output
- Transport stream input: parallel or serial (also applicable as I²S-bus input)
- Peripheral interrupt input: four GPIO pins of the SAA7134HL can be enabled to raise an interrupt on the PCI-bus. By this means, peripheral devices can directly intercept with the device driver on changed status or error conditions

Any GPIO pin that is not used for a dedicated function is available for direct read and write access via the PCI-bus. Any GPIO pin can be selected individually as input or output (masked write). By these means, very tailored interfacing to peripheral devices can be created via the SAA7134HL capture driver running on Windows operating systems.

At system reset (PCI reset) all GPIO pins will be set to 3-state and input, and the logic level present on the GPIO pins at that moment will be saved into a special 'strap' register. All GPIO pins have an internal pull-down resistor (LOW-level), but can be strapped externally with a 4.7 k Ω resistor to the supply voltage (HIGH-level). The device driver can investigate the strap register for information about the hardware configuration of a given board.

7. Limiting values

Table 17: Limiting values

In accordance with the Absolute Maximum Rating System (IEC 60134). All ground pins connected together and grounded (0 V); all supply pins connected together.

Symbol	Parameter	Conditions	Min	Max	Unit
V _{DDD}	digital supply voltage		-0.5	+4.6	V
V _{DDA}	analog supply voltage		-0.5	+4.6	V
ΔV_{SS}	voltage difference between pins V _{SSA} and V _{SSD}		-	100	mV
V _{IA}	input voltage at analog inputs		-0.5	+4.6	V
V _{I(n)}	input voltage at pins XTALI, SDA and SCL		-0.5	V _{DDD} + 0.5	V
V _{ID}	input voltage at digital I/O stages	outputs in 3-state	-0.5	+4.6	V
		outputs in 3-state; 3.0 V < V _{DDD} < 3.6 V	-0.5	+5.5	V
T _{stg}	storage temperature		-65	+150	°C

Table 17: Limiting values...continued

In accordance with the Absolute Maximum Rating System (IEC 60134). All ground pins connected together and grounded (0 V); all supply pins connected together.

Symbol	Parameter	Conditions	Min	Max	Unit
T _{amb}	ambient temperature		0	70	°C
V _{esd}	electrostatic discharge voltage	human body model	[1] -	±2000	V
		machine model	[2] -	±200	V

[1] Class 2 according to EIA/JESD22-114-B.

[2] Class B according to EIA/JESD22-115-A.

8. Thermal characteristics

Table 18: Thermal characteristics

Symbol	Parameter	Conditions	Value	Unit
R _{th(j-a)}	thermal resistance from junction to ambient	in free air	30 [1]	K/W

[1] The overall R_{th(j-a)} value can vary depending on the board layout. To minimize the effective R_{th(j-a)} all power and ground pins must be connected to the power and ground layers directly. An ample copper area direct under the SAA7134HL with a number of through-hole plating, which connect to the ground layer (four-layer board: second layer), can also reduce the effective R_{th(j-a)}. Do not use any solder-stop varnish under the chip. In addition the usage of soldering glue with a high thermal conductance after curing is recommended.

9. Characteristics

Table 19: Characteristics

V_{DDD} = 3.0 V to 3.6 V; V_{DDA} = 3.0 V to 3.6 V; T_{amb} = 25 °C; unless otherwise specified.

Symbol	Parameter	Conditions	Min	Typ	Max	Unit
Supplies						
V _{DDD}	digital supply voltage		3.0	3.3	3.6	V
V _{DDA}	analog supply voltage		3.0	3.3	3.6	V
P	power dissipation	power state				
		D0 for typical application	-	1.1	-	W
		D0 after reset	-	0.1	-	W
		D1	-	0.2	-	W
		D2	-	0.1	-	W
		D3-hot	-	-	0.02	W
Crystal oscillator						
f _{xtal(nom)}	nominal crystal frequency	crystal 1; see Table 20	-	32.11	-	MHz
		crystal 2; see Table 20	-	24.576	-	MHz
Δf _{xtal(nom)}	permissible nominal frequency deviation		-	-	±70 × 10 ⁻⁶	
f _{xtal}	oscillator frequency range		24	32.11	33	MHz
P _{drive}	crystal power level of drive at pin XTALO		-	0.5	-	mW

Table 19: Characteristics...*continued*

$V_{DD} = 3.0\text{ V to }3.6\text{ V}$; $V_{DDA} = 3.0\text{ V to }3.6\text{ V}$; $T_{amb} = 25\text{ }^\circ\text{C}$; unless otherwise specified.

Symbol	Parameter	Conditions	Min	Typ	Max	Unit
t_j	oscillator clock jitter		-	-	± 100	ps
$V_{IH(XTALI)}$	HIGH-level input voltage at pin XTALI		2	-	$V_{DD} + 0.3$	V
$V_{IL(XTALI)}$	LOW-level input voltage at pin XTALI		-0.3	-	+0.8	V

PCI-bus inputs and outputs

V_{IH}	HIGH-level input voltage		2	-	5.75	V
V_{IL}	LOW-level input voltage		-0.5	-	+0.8	V
I_{LIH}	HIGH-level input leakage current	$V_I = 2.7\text{ V}$	[1] -	-	10	μA
I_{LIL}	LOW-level input leakage current	$V_I = 0.5\text{ V}$	[1] -	-	-10	μA
V_{OH}	HIGH-level output voltage	$I_O = -2\text{ mA}$	2.4	-	-	V
V_{OL}	LOW-level output voltage	$I_O = 3\text{ mA or }6\text{ mA}$	[2] -	-	0.55	V
C_i	input capacitance at					
	pin PCI_CLK		5	-	12	pF
	pin IDSEL		-	-	8	pF
	other input pins		-	-	10	pF
SR_r	output rise slew rate	0.4 V to 2.4 V	[3] 1	-	5	V/ns
SR_f	output fall slew rate	2.4 V to 0.4 V	1	-	5	V/ns
t_{val}	CLK to signal valid delay	see Figure 14	[4]			
	bused signals		2	-	11	ns
	point-to-point signals		2	-	12	ns
t_{on}	float-to-active delay	see Figure 14	[5] 2	-	-	ns
t_{off}	active-to-float delay	see Figure 14	[5] -	-	28	ns
t_{su}	input setup time to CLK	see Figure 14	[4]			
	bused signals		7	-	-	ns
	point-to-point signals		10 (12)	-	-	ns
t_h	input hold time from CLK	see Figure 14	0	-	-	ns
$t_{rst(CLK)}$	reset active time after CLK stable		[6] 100	-	-	μs
$t_{rst(off)}$	reset active to output float delay		[5] [6] [7] -	-	40	ns

I²C-bus interface, compatible to 3.3 V and 5 V signalling (pins SDA and SCL)

f_{bit}	bit frequency rate		0	-	400	kbit/s
V_{IL}	LOW-level input voltage		[8] -0.5	-	$0.3 \times V_{DD(I2C)}$	V
V_{IH}	HIGH-level input voltage		[8] $0.7 \times V_{DD(I2C)}$	-	$V_{DD(I2C)} + 0.5$	V
V_{OL}	LOW-level output voltage	$I_{o(sink)} = 3\text{ mA}$	-	-	0.4	V

Table 19: Characteristics...*continued* $V_{DD} = 3.0\text{ V to }3.6\text{ V}$; $V_{DDA} = 3.0\text{ V to }3.6\text{ V}$; $T_{amb} = 25\text{ }^{\circ}\text{C}$; unless otherwise specified.

Symbol	Parameter	Conditions	Min	Typ	Max	Unit
Analog video inputs						
Inputs (pins CV0 to CV4)						
I_{clamp}	clamping current	DC input voltage $V_I = 0.9\text{ V}$	-	± 8	-	μA
$V_{i(\text{p-p})}$	input voltage (peak-to-peak value)		[9] 0.375	0.75	1.07	V
C_i	input capacitance		-	-	10	pF
9-bit analog-to-digital converters						
α_{CS}	channel crosstalk	$f_i < 5\text{ MHz}$	-	-	-50	dB
B	analog bandwidth	at -3 dB; ADC only	[10] -	7	-	MHz
ϕ_{dif}	differential phase	amplifier plus anti-alias filter bypassed	-	2	-	deg
G_{dif}	differential gain	amplifier plus anti-alias filter bypassed	-	2	-	%
$LE_{\text{DC(d)}}$	DC differential linearity error		-	1.4	-	LSB
$LE_{\text{DC(i)}}$	DC integral linearity error		-	2	-	LSB
S/N	signal-to-noise ratio	$f_i = 4\text{ MHz}$; anti-alias filter bypassed; AGC = 0 dB	-	50	-	dB
ENOB	effective number of bits	$f_i = 4\text{ MHz}$; anti-alias filter bypassed; AGC = 0 dB	-	8	-	bit
Analog sound input (pin SIF)						
$V_{i(\text{max})(\text{p-p})}$	maximum input voltage (peak-to-peak value)	input level adjustment at 0 dB	-	941	-	mV
		input level adjustment at -10 dB	-	2976	-	mV
$V_{i(\text{min})(\text{p-p})}$	minimum input voltage for lower limit of AGC (peak-to-peak value)	input level adjustment at 0 dB	-	59	-	mV
		input level adjustment at -10 dB	-	188	-	mV
AGC	AGC range of sound input	in addition to 0 and -10 dB switch	-	24	-	dB
f_i	input frequency		4	-	9.2	MHz
R_i	input resistance	default pre-gain selection for pin SIF (0 dB)	10	-	-	k Ω
C_i	input capacitance		-	7.5	11	pF
Analog audio inputs (pins LEFT1, RIGHT1, LEFT2 and RIGHT2) and outputs (pins OUT_LEFT and OUT_RIGHT)						
$V_{i(\text{nom})(\text{rms})}$	nominal input voltage (RMS value)		[11] -	200	-	mV
$V_{i(\text{max})(\text{rms})}$	maximum input voltage (RMS value)	THD < 3 %	[12] -	1	2	V

Table 19: Characteristics...continued

$V_{DD} = 3.0\text{ V to }3.6\text{ V}$; $V_{DDA} = 3.0\text{ V to }3.6\text{ V}$; $T_{amb} = 25\text{ }^\circ\text{C}$; unless otherwise specified.

Symbol	Parameter	Conditions	Min	Typ	Max	Unit
$V_{o(max)(rms)}$	maximum output voltage (RMS value)	THD < 3 %	-	1	-	V
R_i	input resistance	$V_{i(max)} = 1\text{ V (RMS)}$	-	145	-	k Ω
		$V_{i(max)} = 2\text{ V (RMS)}$	-	48	-	k Ω
R_o	output resistance		150	250	375	Ω
$R_{L(AC)}$	AC load resistance		10	-	-	k Ω
C_L	output load capacitance		-	-	12	nF
$V_{offset(DC)}$	static DC offset voltage		-	10	30	mV
THD + N	total harmonic distortion-plus-noise	$V_i = V_o = 1\text{ V (RMS)}$; $f_i = 1\text{ kHz}$; bandwidth $B = 20\text{ Hz to }20\text{ kHz}$	-	0.1	0.3	%
S/N	signal-to-noise ratio	reference voltage $V_o = 1\text{ V (RMS)}$; $f_i = 1\text{ kHz}$; <i>ITU-R BS.468</i> weighted; quasi peak	70	75	-	dB
α_{ct}	crosstalk attenuation	between any analog input pairs; $f_i = 1\text{ kHz}$	60	-	-	dB
α_{cs}	channel separation	between left and right of each input pair	60	-	-	dB

Sound demodulator performance [13]

$V_{o(nom)(rms)}$	nominal output voltage (RMS value)		[11] -	280	-	mV
Δf_{FM}	FM deviation	B/G standard; THD < 1 %	± 100	-	-	kHz
$\Delta f_{FM(FS)}$	FM deviation at full-scale level	terrestrial FM; level adjustment at 0 dB; demodulator filter bandwidth set to narrow	± 150	-	-	kHz
$\Delta f_{FM(max)}$	maximum FM deviation in high deviation mode	B/G standard; THD < 1 %; demodulator filter bandwidth set to extra wide	± 335	-	-	kHz
C/N_{FM}	FM carrier-to-noise ratio	bandwidth $N_{FM} = 6\text{ MHz}$; white noise for $S/N = 40\text{ dB}$; <i>ITU-R BS.468</i> ; quasi peak	-	77	-	dB/Hz
C/N_N	NICAM carrier-to-noise ratio	bandwidth $N_N = 6\text{ MHz}$; $BER = 10^{-3}$; white noise	-	66	-	dB/Hz
THD + N	total harmonic distortion-plus-noise	from FM source to any output; $f_i = 1\text{ kHz}$; $B = 20\text{ Hz to }20\text{ kHz}$	-	0.3	0.5	%
		from NICAM source to any output; $V_o = 1\text{ V (RMS)}$; $f_i = 1\text{ kHz}$; $B = 20\text{ Hz to }20\text{ kHz}$	-	0.1	0.3	%

Table 19: Characteristics...continued

$V_{DDD} = 3.0\text{ V to }3.6\text{ V}$; $V_{DDA} = 3.0\text{ V to }3.6\text{ V}$; $T_{amb} = 25\text{ }^\circ\text{C}$; unless otherwise specified.

Symbol	Parameter	Conditions	Min	Typ	Max	Unit	
S/N	signal-to-noise ratio	ITU-R BS.468; quasi peak					
		SC1 from FM source to any output	64	70	-	dB	
		SC2 from FM source to any output	60	66	-	dB	
		NICAM source	[14]	-	-	dB	
B _{-3dB}	-3 dB bandwidth	from FM source to any output	14.5	15	-	kHz	
		from NICAM source to any output	14.5	15	-	kHz	
G _{resp}	frequency response from 20 Hz to 14 kHz	from FM or NICAM to any output; reference f = 1 kHz, inclusive pre-emphasis and de-emphasis	-	±2	-	dB	
α _{cs(dual)}	dual signal channel separation		[15]	65	70	-	dB
α _{cs(stereo)}	stereo channel separation		[16]	40	45	-	dB
α _{AM}	AM suppression for FM	FM with 30 % AM (1 kHz) modulation; reference f = 1 kHz and 50 kHz deviation	50	-	-	dB	
dm _{AM}	AM demodulation	SIF level is 100 mV (RMS); 54 % AM; 1 kHz AF; ITU-R BS.468; quasi peak	36	45	-	dB	

Identification for FM systems

m _{pilot}	pilot modulation for identification		25	50	75	%
C/N _{pilot}	pilot sideband carrier-to-noise ratio for identification start		-	27	-	dB/Hz
t _{ident(on)}	total identification time on	slow mode	-	-	2	s
		medium mode	-	-	1	s
		fast mode	-	-	0.5	s
t _{ident(off)}	total identification time off	slow mode	-	-	2	s
		medium mode	-	-	1	s
		fast mode	-	-	0.5	s

All digital I/Os: GPIO pins and BST test pins (5 V tolerant)

Pins GPIO0 to GPIO23, V_CLK, GPIO25 to GPIO27, TDI, TDO, TMS, TCK and TRST_N

V _{IH}	HIGH-level input voltage	2.0	-	5.5	V
V _{IL}	LOW-level input voltage	-0.3	-	+0.8	V
I _{LI}	input leakage current	-	-	1	μA

Table 19: Characteristics...*continued*

$V_{DD} = 3.0\text{ V to }3.6\text{ V}$; $V_{DDA} = 3.0\text{ V to }3.6\text{ V}$; $T_{amb} = 25\text{ }^{\circ}\text{C}$; unless otherwise specified.

Symbol	Parameter	Conditions	Min	Typ	Max	Unit
$I_{L(I/O)}$	I/O leakage current	3.3 V signal levels at $V_{DD} \geq 3.3\text{ V}$	-	-	10	μA
C_i	input capacitance	I/O at high-impedance	-	-	8	pF
R_{pd}	pull-down resistance	$V_I = V_{DD}$	-	50	-	$\text{k}\Omega$
R_{pu}	pull-up resistance	$V_I = 0$	-	50	-	$\text{k}\Omega$
V_{OH}	HIGH-level output voltage	$I_O = -2\text{ mA}$	2.4	-	$V_{DD} + 0.5$	V
V_{OL}	LOW-level output voltage	$I_O = 2\text{ mA}$	0	-	0.4	V

Audio-video port outputs (digital video stream from comb filter decoder or scaler, digital audio from sound decoder or baseband audio inputs via I²S-bus)

LLC and LLC2 clock output on pin V_CLK; see [Figure 15](#)

C_L	load capacitance		15	-	50	pF
T_{cy}	cycle time	LLC active	35	-	39	ns
		LLC2 active	70	-	78	ns
δ	duty factor	$C_L = 40\text{ pF}$	[17]			
		LCC active	35	-	65	%
		LCC2 active	35	-	65	%
t_r	rise time	0.4 V to 2.4 V	-	-	5	ns
t_f	fall time	2.4 V to 0.4 V	-	-	5	ns

Video data output with respect to signal V_CLK on pins GPIO0 to GPIO17, GPIO22 and GPIO23; see [Figure 15](#)

C_L	load capacitance		15	-	50	pF
t_h	data hold time		[18] [19]			
		LLC active	5	-	-	ns
		LLC2 active	15	-	-	ns
t_{PD}	propagation delay from positive edge of signal V_CLK		[18] [19]			
		LLC active	-	-	28	ns
		LLC2 active	-	-	55	ns

Raw DTV/DVB outputs (reuse of video ADCs in DVB/TV applications with TDA8960 and TDA8961 for VSB reception)

Clock input signal X_CLK_IN on pin GPIO18

T_{cy}	cycle time		27.8	37	333	ns
δ	duty factor		[17] 40	50	60	%
t_r	rise time	0.8 V to 2.0 V	-	-	5	ns
t_f	fall time	2.0 V to 0.8 V	-	-	5	ns

Clock output signal ADC_CLK on pin V_CLK

C_L	load capacitance		-	-	25	pF
T_{cy}	cycle time		27.8	-	-	ns
δ	duty factor	$C_L = 40\text{ pF}$	[17] 40	-	60	%
t_r	rise time	0.4 V to 2.4 V	-	-	5	ns
t_f	fall time	2.4 V to 0.4 V	-	-	5	ns

Table 19: Characteristics...*continued*

$V_{DD} = 3.0\text{ V to }3.6\text{ V}$; $V_{DDA} = 3.0\text{ V to }3.6\text{ V}$; $T_{amb} = 25\text{ }^{\circ}\text{C}$; unless otherwise specified.

Symbol	Parameter	Conditions	Min	Typ	Max	Unit
VSB data output signals with respect to signal ADC_CLK						
C_L	load capacitance		25	-	50	pF
t_h	data hold time	inverted and not delayed	[18] 5	-	-	ns
t_{PD}	propagation delay from positive edge of signal ADC_CLK	inverted and not delayed	[18] [20] -	-	23	ns

TS capture inputs with parallel transport streaming (TS-P); e.g. DVB applications

Clock input signal TS_CLK on pin GPIO20; see [Figure 16](#)

T_{cy}	cycle time		-	333	-	ns
δ	duty factor		[17] 40	-	60	%
t_r	rise time	0.8 V to 2.0 V	-	-	5	ns
t_f	fall time	2.0 V to 0.8 V	-	-	5	ns

Data and control input signals on TS-P port (with respect to signal TS_CLK) on pins GPIO0 to GPIO7, GPIO16, GPIO19 and GPIO22; see [Figure 16](#)

$t_{su(D)}$	input data setup time		2	-	-	ns
$t_{h(D)}$	input data hold time		5	-	-	ns

TS capture inputs with serial transport streaming (TS-S); e.g. DVB applications

Clock input signal TS_CLK on pin GPIO20; see [Figure 16](#)

T_{cy}	cycle time		37	-	-	ns
δ	duty factor		[17] 40	-	60	%
t_r	rise time	0.8 V to 2.0 V	-	-	5	ns
t_f	fall time	2.0 V to 0.8 V	-	-	5	ns

Data and control input signals on TS-S port (with respect to signal TS_CLK) on pins GPIO16, GPIO19, GPIO21 and GPIO22; see [Figure 16](#)

$t_{su(D)}$	input data setup time		2	-	-	ns
$t_{h(D)}$	input data hold time		5	-	-	ns

- [1] Input leakage currents include high-impedance output leakage for all bidirectional buffers with 3-state outputs.
- [2] Pins without pull-up resistors must have a 3 mA output current. Pins requiring pull-up resistors must have 6 mA; these are pins FRAME#, TRDY#, IRDY#, DEVSEL#, SERR#, PERR#, INT_A and STOP#.
- [3] This parameter is to be interpreted as the cumulative edge rate across the specified range, rather than the instantaneous rate at any point within the transition range.
- [4] REQ# and GNT# are point-to-point signals and have different output valid delay and input setup times than bused signals. GNT# has a setup time of 10 ns. REQ# has a setup time of 12 ns.
- [5] For purposes of active or float timing measurements, the high-impedance or 'off' state is defined to be when the total current delivered through the device is less than or equal to the leakage current specification.
- [6] RST_N is asserted and de-asserted asynchronously with respect to CLK.
- [7] All output drivers floated asynchronously when RST_N is active.
- [8] $V_{DD(I2C)}$ is the extended pull-up voltage of the I²C-bus (3.3 V or 5 V bus).
- [9] Nominal analog video input signal is to be terminated by 75 Ω that results in 1 V (p-p) amplitude. This termination resistor should be split into 18 Ω and 56 Ω, and the dividing tap should feed the video input pin, via a coupling capacitor of 47 nF, to achieve a control range from -3 dB (attenuation) to +6 dB (amplification) for the internal automatic gain control. See also *Application note SAA7130HL/34HL*.
- [10] See *User manual SAA7130HL/34HL* for Anti-Alias Filter (AAF).
- [11] Definition of levels and level setting:

The full-scale level for analog audio signals $V_{FS} = 0.8 \text{ V}$ (RMS). The nominal level at the digital crossbar switch is defined at -15 dB (FS).

Nominal audio input levels: external, mono, $V_i = 280 \text{ mV}$ (RMS); -9 dB (FS).

- [12] The analog audio inputs (pins LEFT1, RIGHT1, LEFT2 and RIGHT2) are supported by two input levels: 1 V (RMS) and 2 V (RMS), selectable independently per stereo input pair, LEFT1, RIGHT1 and LEFT2, RIGHT2.
- [13] $V_{DDA} = 3.3 \text{ V}$; settings in accordance with B/G standard; FM deviation is $\pm 50 \text{ kHz}$; $f_{mod} = 1 \text{ kHz}$; FM sound parameters in accordance with system A2; NICAM in accordance with EBU specification; 1 k Ω measurement source resistance for AF inputs; $V_{i(SIF)} = 300 \text{ mV}$ (p-p); programming registers AGCOFF = 0 and AGCSLOW = 1; level and gain settings according to [Table note 11](#); for external components see the application diagram in SAA7130HL and SAA7134HL application notes; unless otherwise specified.
- [14] The NICAM values are in accordance with the EBU specification. Audio performance is limited by the dynamic range of the NICAM 728 system. Due to companding, the quantization noise is never lower than -62 dB with respect to the input level.
- [15] FM source; in dual mode only A (respectively B) signal modulated; measured at B (respectively A) channel output; $V_o = 0.8 \text{ V}$ (RMS) of modulated channel.
- [16] FM source; in stereo mode only L (respectively R) signal modulated; measured at R (respectively L) channel output; $V_o = 0.8 \text{ V}$ (RMS) of modulated channel.
- [17] The definition of the duty factor: $\delta = \frac{t_H}{T_{cy}}$
- [18] The output timing must be measured with the load of a 30 pF capacitor to ground and a 500 Ω resistor to 1.4 V.
- [19] Signal V_CLK inverted; not delayed (default setup).
- [20] $t_{PD} = 6 \text{ ns} + 0.6 \times T_{ADC_CLK}$ in ns ($T_{ADC_CLK} = 28 \text{ ns}$).

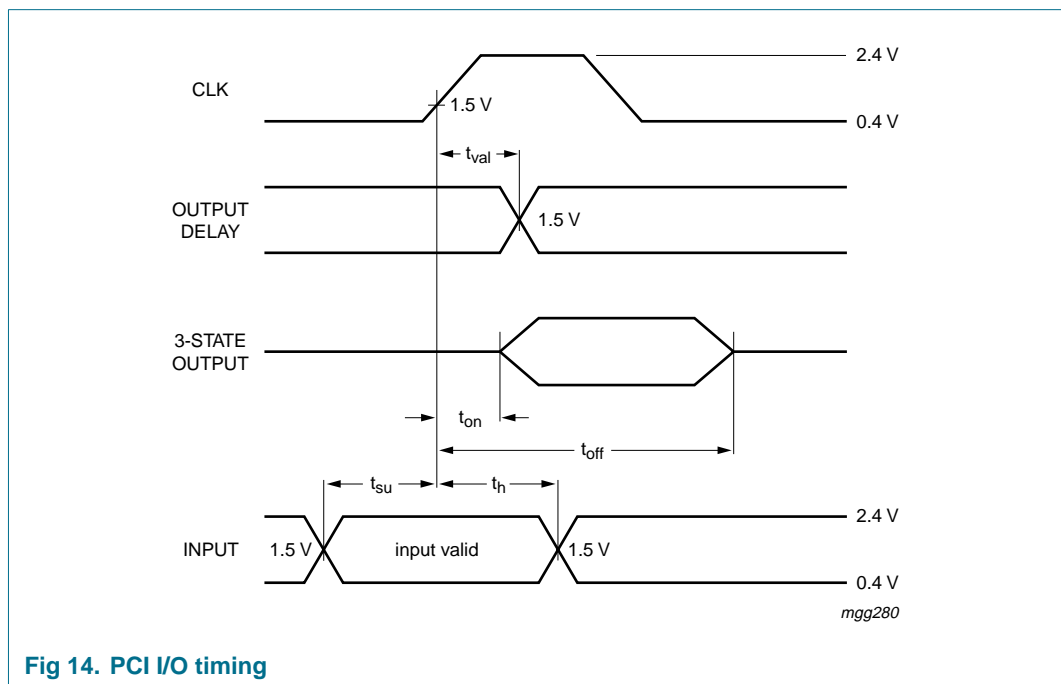

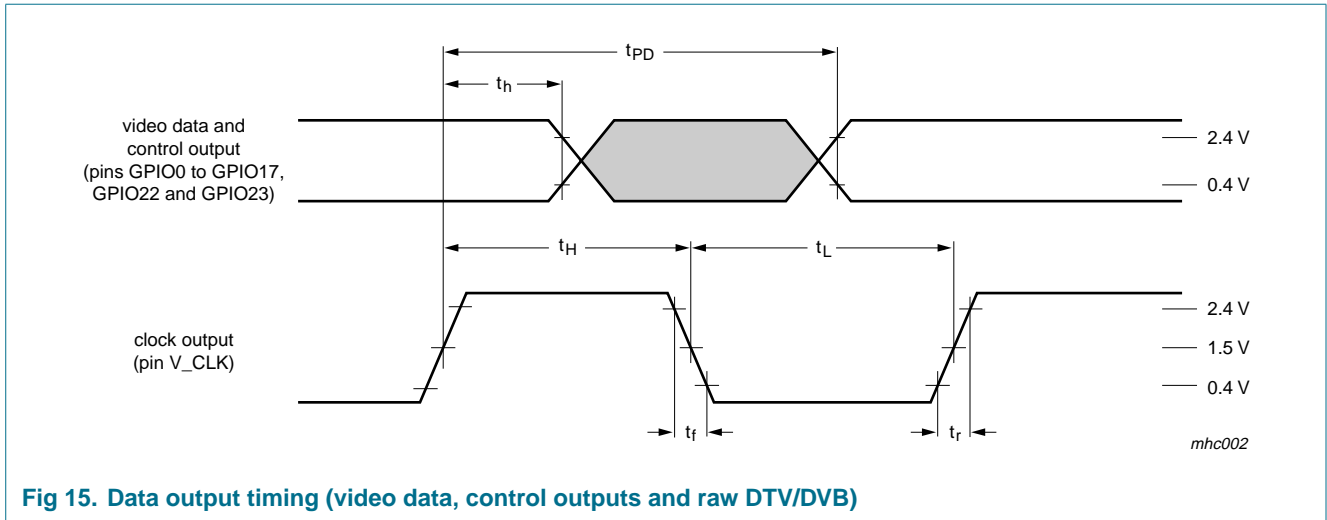

Fig 15. Data output timing (video data, control outputs and raw DTV/DVB)

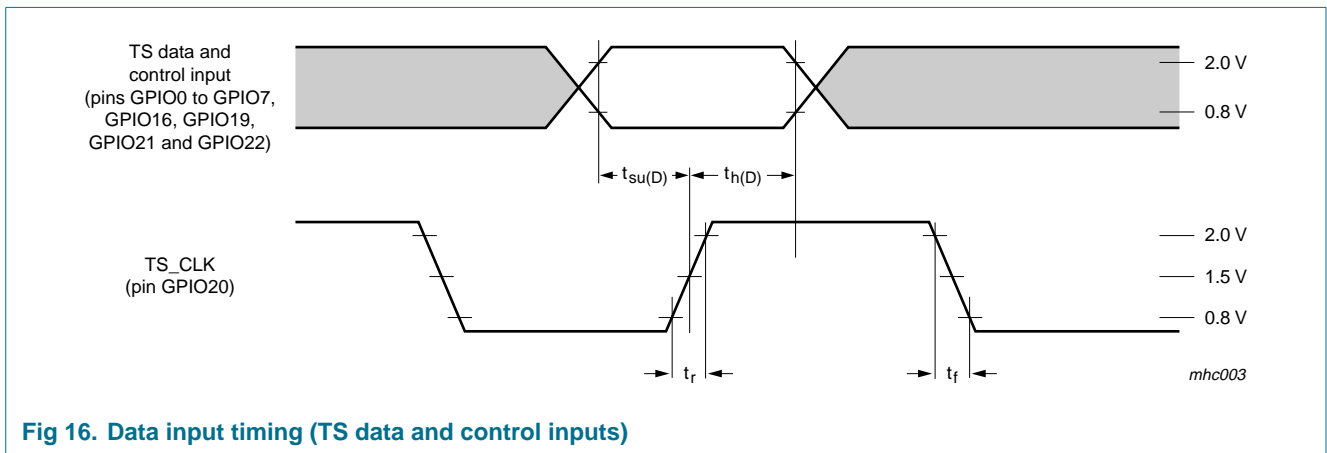

Fig 16. Data input timing (TS data and control inputs)

Table 20: Specification of crystals and related applications (examples) [1]

Standard	Crystal frequency						Unit
	32.11 MHz			24.576 MHz			
	Fundamental		3rd harmonic	Fundamental		3rd harmonic	
	1B	1C	1A	2B	2C	2A	
Typical load capacitance	20	8	8	20	8	10	pF
Maximum series resonance resistance	30	60	50	30	60	80	Ω
Typical motional capacitance	20	13.5	1.5	20	1	1.5	fF
Maximum parallel capacitance	7	3 ± 1	4.3	7	3.3	3.5	pF
Maximum permissible deviation	$\pm 30 \times 10^{-6}$	$\pm 30 \times 10^{-6}$	$\pm 30 \times 10^{-6}$	$\pm 30 \times 10^{-6}$	$\pm 30 \times 10^{-6}$	$\pm 50 \times 10^{-6}$	
Maximum temperature deviation	$\pm 30 \times 10^{-6}$	$\pm 30 \times 10^{-6}$	$\pm 30 \times 10^{-6}$	$\pm 30 \times 10^{-6}$	$\pm 30 \times 10^{-6}$	$\pm 20 \times 10^{-6}$	

Table 20: Specification of crystals and related applications (examples) [1]...continued

Standard	Crystal frequency						Unit
	32.11 MHz			24.576 MHz			
	Fundamental		3rd harmonic	Fundamental		3rd harmonic	
	1B	1C	1A	2B	2C	2A	
External components							
Typical load capacitance at pin XTALI	33	10	15	27	5.6	18	pF
Typical load capacitance at pin XTALO	33	10	15	27	5.6	18	pF
Typical capacitance of LC filter	n.a.	n.a.	1	n.a.	n.a.	1	nF
Typical inductance of LC filter	n.a.	n.a.	4.7	n.a.	n.a.	4.7	μH

[1] For oscillator application, see the *Application note of the SAA7130HL/34HL*.

10. Test information

10.1 Boundary scan test

The SAA7134HL has built-in logic and five dedicated pins to support boundary scan testing which allows board testing without special hardware (nails).

The SAA7134HL follows the *IEEE Std. 1149.1 - Standard Test Access Port and Boundary - Scan Architecture* set by the Joint Test Action Group (JTAG) chaired by Philips.

The 5 special pins are: Test Mode Select (TMS), Test Clock (TCK), Test Reset (TRST_N), Test Data Input (TDI) and Test Data Output (TDO).

The Boundary Scan Test (BST) functions BYPASS, EXTEST, SAMPLE, CLAMP and IDCODE are all supported (see [Table 21](#)). Details about the JTAG BST-test can be found in the specification *IEEE Std. 1149.1*. A file containing the detailed Boundary Scan Description Language (BSDL) description of the SAA7134HL is available on request.

10.1.1 Initialization of boundary scan circuit

The Test Access Port (TAP) controller of an IC should be in the reset state (TEST_LOGIC_RESET) when the IC is in the functional mode. This reset state also forces the instruction register into a functional instruction such as IDCODE or BYPASS.

To solve the power-up reset, the standard specifies that the TAP controller will be forced asynchronously to the TEST_LOGIC_RESET state by setting pin TRST_N to LOW-level.

10.1.2 Device identification codes

When the IDCODE instruction is loaded into the BST instruction register, the identification register will be connected internally between pins TDI and TDO of the IC. The identification register will load a component specific code during the CAPTURE_DATA_REGISTER state of the TAP controller and this code can subsequently be shifted out. At board level, this code can be used to verify component manufacturer,

type and version number. The device identification register contains 32 bits, numbered 31 to 0, where bit 31 is the most significant bit (nearest to TDI) and bit 0 is the least significant bit (nearest to TDO); see [Figure 17](#).

A device identification register is specified in *IEEE Std. 1149.1b-1994*. It is a 32-bit register which contains fields for the specification of the IC manufacturer, the IC part number and the IC version number. Its biggest advantage is the possibility to check for the correct ICs mounted after production and determination of the version number of ICs during field service.

Table 21: BST instructions supported by the SAA7134HL

Instruction	Description
BYPASS	This mandatory instruction provides a minimum length serial path (1-bit) between pins TDI and TDO when no test operation of the component is required.
EXTEST	This mandatory instruction allows testing of off-chip circuitry and board level interconnections.
SAMPLE	This mandatory instruction can be used to take a sample of the inputs during normal operation of the component. It can also be used to preload data values into the latched outputs of the boundary scan register.
CLAMP	This optional instruction is useful for testing when not all ICs have BST. This instruction addresses the bypass register while the boundary scan register is in external test mode.
IDCODE	This optional instruction will provide information on the components manufacturer, part number and version number.

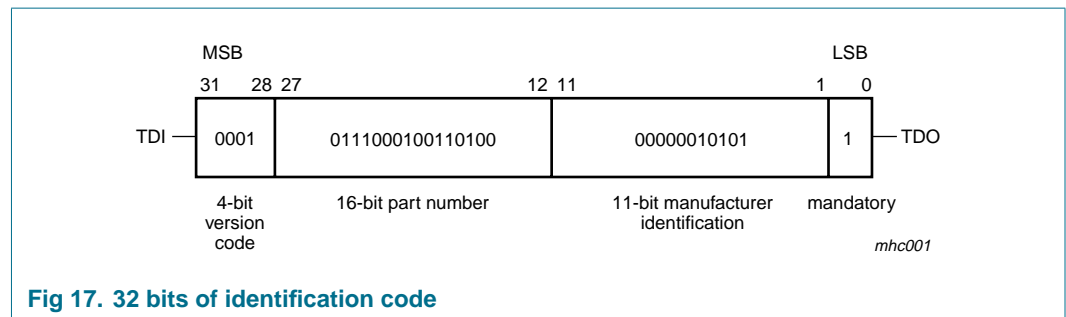

Fig 17. 32 bits of identification code

11. Package outline

LQFP128: plastic low profile quad flat package; 128 leads; body 14 x 20 x 1.4 mm

SOT425-1

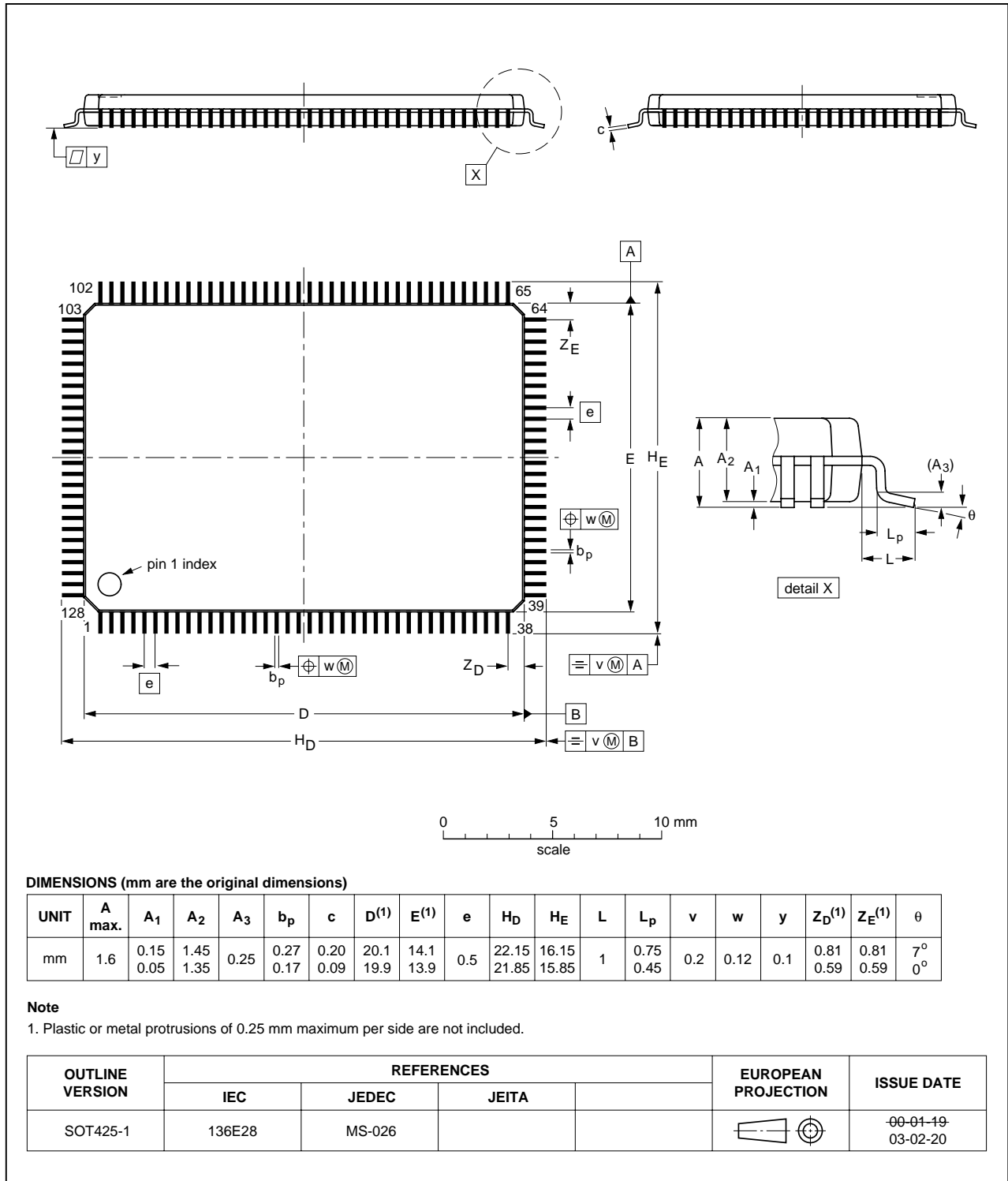

Fig 18. Package outline SOT425-1 (LQFP128)

12. Soldering

12.1 Introduction to soldering surface mount packages

This text gives a very brief insight to a complex technology. A more in-depth account of soldering ICs can be found in our *Data Handbook IC26; Integrated Circuit Packages* (document order number 9398 652 90011).

There is no soldering method that is ideal for all surface mount IC packages. Wave soldering can still be used for certain surface mount ICs, but it is not suitable for fine pitch SMDs. In these situations reflow soldering is recommended.

12.2 Reflow soldering

Reflow soldering requires solder paste (a suspension of fine solder particles, flux and binding agent) to be applied to the printed-circuit board by screen printing, stencilling or pressure-syringe dispensing before package placement. Driven by legislation and environmental forces the worldwide use of lead-free solder pastes is increasing.

Several methods exist for reflowing; for example, convection or convection/infrared heating in a conveyor type oven. Throughput times (preheating, soldering and cooling) vary between 100 seconds and 200 seconds depending on heating method.

Typical reflow peak temperatures range from 215 °C to 270 °C depending on solder paste material. The top-surface temperature of the packages should preferably be kept:

- below 225 °C (SnPb process) or below 245 °C (Pb-free process)
 - for all BGA, HTSSON..T and SSOP..T packages
 - for packages with a thickness ≥ 2.5 mm
 - for packages with a thickness < 2.5 mm and a volume ≥ 350 mm³ so called thick/large packages.
- below 240 °C (SnPb process) or below 260 °C (Pb-free process) for packages with a thickness < 2.5 mm and a volume < 350 mm³ so called small/thin packages.

Moisture sensitivity precautions, as indicated on packing, must be respected at all times.

12.3 Wave soldering

Conventional single wave soldering is not recommended for surface mount devices (SMDs) or printed-circuit boards with a high component density, as solder bridging and non-wetting can present major problems.

To overcome these problems the double-wave soldering method was specifically developed.

If wave soldering is used the following conditions must be observed for optimal results:

- Use a double-wave soldering method comprising a turbulent wave with high upward pressure followed by a smooth laminar wave.
- For packages with leads on two sides and a pitch (e):
 - larger than or equal to 1.27 mm, the footprint longitudinal axis is **preferred** to be parallel to the transport direction of the printed-circuit board;

- smaller than 1.27 mm, the footprint longitudinal axis **must** be parallel to the transport direction of the printed-circuit board.

The footprint must incorporate solder thieves at the downstream end.

- For packages with leads on four sides, the footprint must be placed at a 45° angle to the transport direction of the printed-circuit board. The footprint must incorporate solder thieves downstream and at the side corners.

During placement and before soldering, the package must be fixed with a droplet of adhesive. The adhesive can be applied by screen printing, pin transfer or syringe dispensing. The package can be soldered after the adhesive is cured.

Typical dwell time of the leads in the wave ranges from 3 seconds to 4 seconds at 250 °C or 265 °C, depending on solder material applied, SnPb or Pb-free respectively.

A mildly-activated flux will eliminate the need for removal of corrosive residues in most applications.

12.4 Manual soldering

Fix the component by first soldering two diagonally-opposite end leads. Use a low voltage (24 V or less) soldering iron applied to the flat part of the lead. Contact time must be limited to 10 seconds at up to 300 °C.

When using a dedicated tool, all other leads can be soldered in one operation within 2 seconds to 5 seconds between 270 °C and 320 °C.

12.5 Package related soldering information

Table 22: Suitability of surface mount IC packages for wave and reflow soldering methods

Package [1]	Soldering method	
	Wave	Reflow [2]
BGA, HTSSON..T [3], LBGA, LFBGA, SQFP, SSOP..T [3], TFBGA, VFBGA, XSON	not suitable	suitable
DHVQFN, HBCC, HBGA, HLQFP, HSO, HSOP, HSQFP, HSSON, HTQFP, HTSSOP, HVQFN, HVSON, SMS	not suitable [4]	suitable
PLCC [5], SO, SOJ	suitable	suitable
LQFP, QFP, TQFP	not recommended [5] [6]	suitable
SSOP, TSSOP, VSO, VSSOP	not recommended [7]	suitable
CWQCCN..L [8], PMFP [9], WQCCN..L [8]	not suitable	not suitable

[1] For more detailed information on the BGA packages refer to the *(LF)BGA Application Note (AN01026)*; order a copy from your Philips Semiconductors sales office.

[2] All surface mount (SMD) packages are moisture sensitive. Depending upon the moisture content, the maximum temperature (with respect to time) and body size of the package, there is a risk that internal or external package cracks may occur due to vaporization of the moisture in them (the so called popcorn effect). For details, refer to the Drypack information in the *Data Handbook IC26; Integrated Circuit Packages; Section: Packing Methods*.

[3] These transparent plastic packages are extremely sensitive to reflow soldering conditions and must on no account be processed through more than one soldering cycle or subjected to infrared reflow soldering with peak temperature exceeding 217 °C ± 10 °C measured in the atmosphere of the reflow oven. The package body peak temperature must be kept as low as possible.

- [4] These packages are not suitable for wave soldering. On versions with the heatsink on the bottom side, the solder cannot penetrate between the printed-circuit board and the heatsink. On versions with the heatsink on the top side, the solder might be deposited on the heatsink surface.
- [5] If wave soldering is considered, then the package must be placed at a 45° angle to the solder wave direction. The package footprint must incorporate solder thieves downstream and at the side corners.
- [6] Wave soldering is suitable for LQFP, QFP and TQFP packages with a pitch (e) larger than 0.8 mm; it is definitely not suitable for packages with a pitch (e) equal to or smaller than 0.65 mm.
- [7] Wave soldering is suitable for SSOP, TSSOP, VSO and VSSOP packages with a pitch (e) equal to or larger than 0.65 mm; it is definitely not suitable for packages with a pitch (e) equal to or smaller than 0.5 mm.
- [8] Image sensor packages in principle should not be soldered. They are mounted in sockets or delivered pre-mounted on flex foil. However, the image sensor package can be mounted by the client on a flex foil by using a hot bar soldering process. The appropriate soldering profile can be provided on request.
- [9] Hot bar soldering or manual soldering is suitable for PMFP packages.

13. Revision history

Table 23: Revision history

Document ID	Release date	Data sheet status	Change notice	Doc. number	Supersedes
SAA7134HL_4	20060331	Product data sheet	-	-	SAA7134HL_3
Modifications:	• Table 1 : deleted rows “Dolby Pro Logic” and “virtual Dolby Surround” at TV parameter Audio.				
SAA7134HL_3	20050503	Product data sheet	-	9397 750 14309	SAA7134HL_2
SAA7134HL_2	20021217	Product specification	-	9397 750 10357	SAA7134HL_1
SAA7134HL_1	20020423	Product specification	-	9397 750 08671	-

14. Data sheet status

Level	Data sheet status ^[1]	Product status ^{[2] [3]}	Definition
I	Objective data	Development	This data sheet contains data from the objective specification for product development. Philips Semiconductors reserves the right to change the specification in any manner without notice.
II	Preliminary data	Qualification	This data sheet contains data from the preliminary specification. Supplementary data will be published at a later date. Philips Semiconductors reserves the right to change the specification without notice, in order to improve the design and supply the best possible product.
III	Product data	Production	This data sheet contains data from the product specification. Philips Semiconductors reserves the right to make changes at any time in order to improve the design, manufacturing and supply. Relevant changes will be communicated via a Customer Product/Process Change Notification (CPCN).

[1] Please consult the most recently issued data sheet before initiating or completing a design.

[2] The product status of the device(s) described in this data sheet may have changed since this data sheet was published. The latest information is available on the Internet at URL <http://www.semiconductors.philips.com>.

[3] For data sheets describing multiple type numbers, the highest-level product status determines the data sheet status.

15. Definitions

Short-form specification — The data in a short-form specification is extracted from a full data sheet with the same type number and title. For detailed information see the relevant data sheet or data handbook.

Limiting values definition — Limiting values given are in accordance with the Absolute Maximum Rating System (IEC 60134). Stress above one or more of the limiting values may cause permanent damage to the device. These are stress ratings only and operation of the device at these or at any other conditions above those given in the Characteristics sections of the specification is not implied. Exposure to limiting values for extended periods may affect device reliability.

Application information — Applications that are described herein for any of these products are for illustrative purposes only. Philips Semiconductors makes no representation or warranty that such applications will be suitable for the specified use without further testing or modification.

16. Disclaimers

Life support — These products are not designed for use in life support appliances, devices, or systems where malfunction of these products can reasonably be expected to result in personal injury. Philips Semiconductors customers using or selling these products for use in such applications do so at their own risk and agree to fully indemnify Philips Semiconductors for any damages resulting from such application.

Right to make changes — Philips Semiconductors reserves the right to make changes in the products - including circuits, standard cells, and/or software - described or contained herein in order to improve design and/or

performance. When the product is in full production (status 'Production'), relevant changes will be communicated via a Customer Product/Process Change Notification (CPCN). Philips Semiconductors assumes no responsibility or liability for the use of any of these products, conveys no license or title under any patent, copyright, or mask work right to these products, and makes no representations or warranties that these products are free from patent, copyright, or mask work right infringement, unless otherwise specified.

ICs with MPEG-2 functionality — Use of this product in any manner that complies with the MPEG-2 Standard is expressly prohibited without a license under applicable patents in the MPEG-2 patent portfolio, which license is available from MPEG LA, L.L.C., 250 Steele Street, Suite 300, Denver, Colorado 80206.

ICs with MPEG-audio/AC-3/DTS audio functionality — Purchase of a Philips IC with an MPEG-audio and/or AC-3 and/or DTS audio functionality does not convey an implied license under any patent right to use this IC in any MPEG-audio or AC-3 or DTS audio application. A license for MPEG-audio needs to be obtained via Sisvel S.p.a. - Società per lo Sviluppo dell'Electronica Via Castagnole, 59 . 10060 None (TO) Italy. A license for AC-3 and/or DTS needs to be obtained via Philips Intellectual Property and Standards (www.ip.philips.com), e-mail: info.licensing@philips.com.

17. Trademarks

Notice — All referenced brands, product names, service names and trademarks are the property of their respective owners.

IPC-bus — logo is a trademark of Koninklijke Philips Electronics N.V.

18. Contact information

For additional information, please visit: <http://www.semiconductors.philips.com>

For sales office addresses, send an email to: sales.addresses@www.semiconductors.philips.com

19. Contents

1	General description	1	6.9.2	Propagate reset	33
1.1	Introduction	1	6.9.3	GPIO	33
1.2	Overview of TV decoders with PCI bridge	2	7	Limiting values	33
1.3	Related documents	3	8	Thermal characteristics	34
2	Features	4	9	Characteristics	34
2.1	PCI and DMA bus mastering	4	10	Test information	43
2.2	TV video decoder and video scaling	4	10.1	Boundary scan test	43
2.3	TV sound decoder and audio I/O	4	10.1.1	Initialization of boundary scan circuit	43
2.4	Peripheral interface	4	10.1.2	Device identification codes	43
2.5	General	5	11	Package outline	45
3	Ordering information	5	12	Soldering	46
4	Block diagram	6	12.1	Introduction to soldering surface mount packages	46
5	Pinning information	7	12.2	Reflow soldering	46
5.1	Pinning	7	12.3	Wave soldering	46
5.2	Pin description	8	12.4	Manual soldering	47
5.2.1	Pin type description	12	12.5	Package related soldering information	47
6	Functional description	13	13	Revision history	49
6.1	Overview of internal functions	13	14	Data sheet status	50
6.2	Application examples	15	15	Definitions	50
6.3	Software support	17	16	Disclaimers	50
6.3.1	Device driver	17	17	Trademarks	50
6.3.2	Supporting WDM	18	18	Contact information	50
6.4	PCI interface	18			
6.4.1	PCI configuration registers	18			
6.4.2	ACPI and power states	19			
6.4.3	DMA and configurable FIFO	20			
6.4.4	Virtual and physical addressing	20			
6.4.5	Status and interrupts on PCI-bus	21			
6.5	Analog TV standards	22			
6.6	Video processing	24			
6.6.1	Analog video inputs	24			
6.6.2	Video synchronization and line-locked clock	24			
6.6.3	Video decoding and automatic standard detection	24			
6.6.4	Adaptive comb filter	24			
6.6.5	Macrovision detection	25			
6.6.6	Video scaling	25			
6.6.7	VBI data	28			
6.6.8	Signal levels and color space	28			
6.6.9	Video port, ITU and VIP codes	30			
6.7	TV sound	31			
6.7.1	TV sound stereo decoding	31			
6.7.2	Analog audio pass-through and loop back cable	32			
6.8	DTV/DVB channel decoding and TS capture	32			
6.9	Control of peripheral devices	32			
6.9.1	I ² C-bus master	32			

© Koninklijke Philips Electronics N.V. 2006

All rights are reserved. Reproduction in whole or in part is prohibited without the prior written consent of the copyright owner. The information presented in this document does not form part of any quotation or contract, is believed to be accurate and reliable and may be changed without notice. No liability will be accepted by the publisher for any consequence of its use. Publication thereof does not convey nor imply any license under patent- or other industrial or intellectual property rights.

Date of release: 31 March 2006
Document number: SAA7134HL_4

Published in The Netherlands

