

DATA SHEET

TDA1013B

**4 W audio power amplifier with
DC volume control**

Product specification
File under Integrated Circuits, IC01

July 1994

4 W audio power amplifier with DC volume control

TDA1013B

GENERAL DESCRIPTION

The TDA1013B is an integrated audio amplifier circuit with DC volume control, encapsulated in a 9-lead single in-line (SIL) plastic package. The wide supply voltage range makes this circuit ideal for applications in mains and battery-fed apparatus such as television receivers and record players.

The DC volume control stage has a logarithmic control characteristic with a range of more than 80 dB; control is by means of a DC voltage variable between 2 and 6.5 V.

The audio amplifier has a well defined open loop gain and a fixed integrated closed loop. This device requires only a few external components and offers stability and performance.

Features

- Few external components
- Wide supply voltage range
- Wide control range
- Pin compatible with TDA1013A
- Fixed gain
- High signal-to-noise ratio
- Thermal protection

QUICK REFERENCE DATA

PARAMETER	CONDITIONS	SYMBOL	MIN.	TYP.	MAX.	UNIT
Supply voltage		V_P	10	18	40	V
Repetitive peak output current		I_{ORM}	–	–	1.5	A
Total sensitivity	$P_o = 2.5$ W; DC control at max. gain	V_i	44	55	69	mV
Audio amplifier						
Output power	THD = 10%; $R_L = 8 \Omega$	P_o	4.0	4.2	–	W
Total harmonic distortion	$P_o = 2.5$ W; $R_L = 8 \Omega$	THD	–	0.15	0.1	%
Sensitivity	$P_o = 2.5$ W	V_i	100	125	160	mV
DC volume control unit						
Gain control range		$ \Delta G_v $	80	–	–	dB
Signal handling	THD < 1%; DC control = 0 dB	V_i	1.2	1.7	–	V
Sensitivity (pin 6)	$V_o = 125$ mV; max. voltage gain	V_i	39	45	55	mV
Input impedance (pin 8)		$ Z_i $	23	29	35	k Ω

PACKAGE OUTLINE

9-lead SIL; plastic (SOT110B); SOT110-1; 1996 July 23.

4 W audio power amplifier with DC volume control

TDA1013B

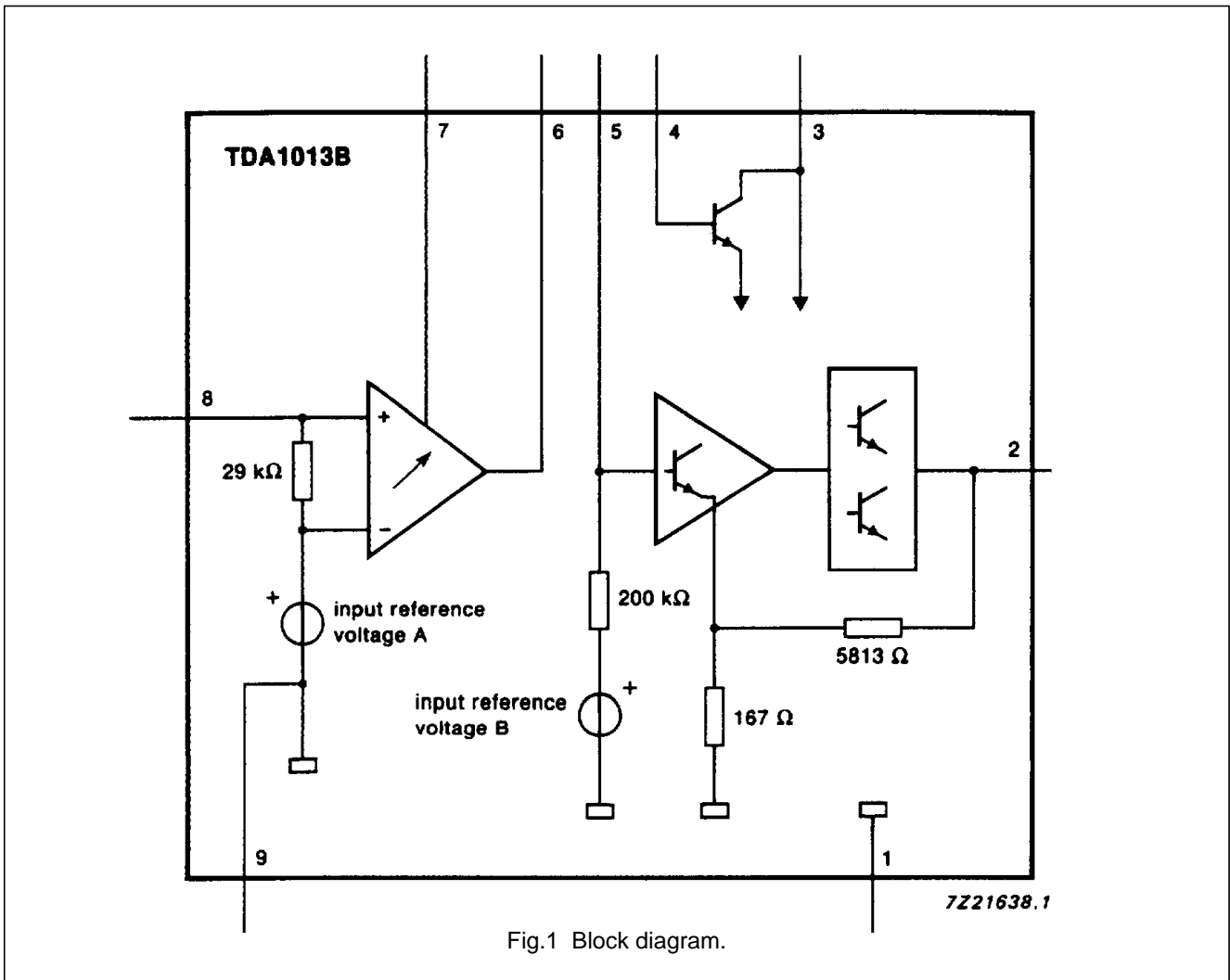

Fig.1 Block diagram.

PINNING

- 1. power ground
- 2. amplifier output
- 3. supply voltage
- 4. electronic filter
- 5. amplifier input
- 6. control unit output
- 7. control voltage
- 8. control unit input
- 9. signal ground (substrate)

4 W audio power amplifier with
DC volume control

TDA1013B

RATINGS

Limiting values in accordance with the Absolute Maximum System (IEC 134)

SYMBOL	PARAMETER	MIN.	MAX.	UNIT
V _P	Supply voltage	–	40	V
I _{OSM}	Non-repetitive peak output current	–	3	A
I _{ORM}	Repetitive peak output current	–	1.5	A
T _{stg}	Storage temperature range	–55	+150	°C
T _C	Crystal temperature	–	+150	°C
P _{tot}	Total power dissipation		see Fig.2	

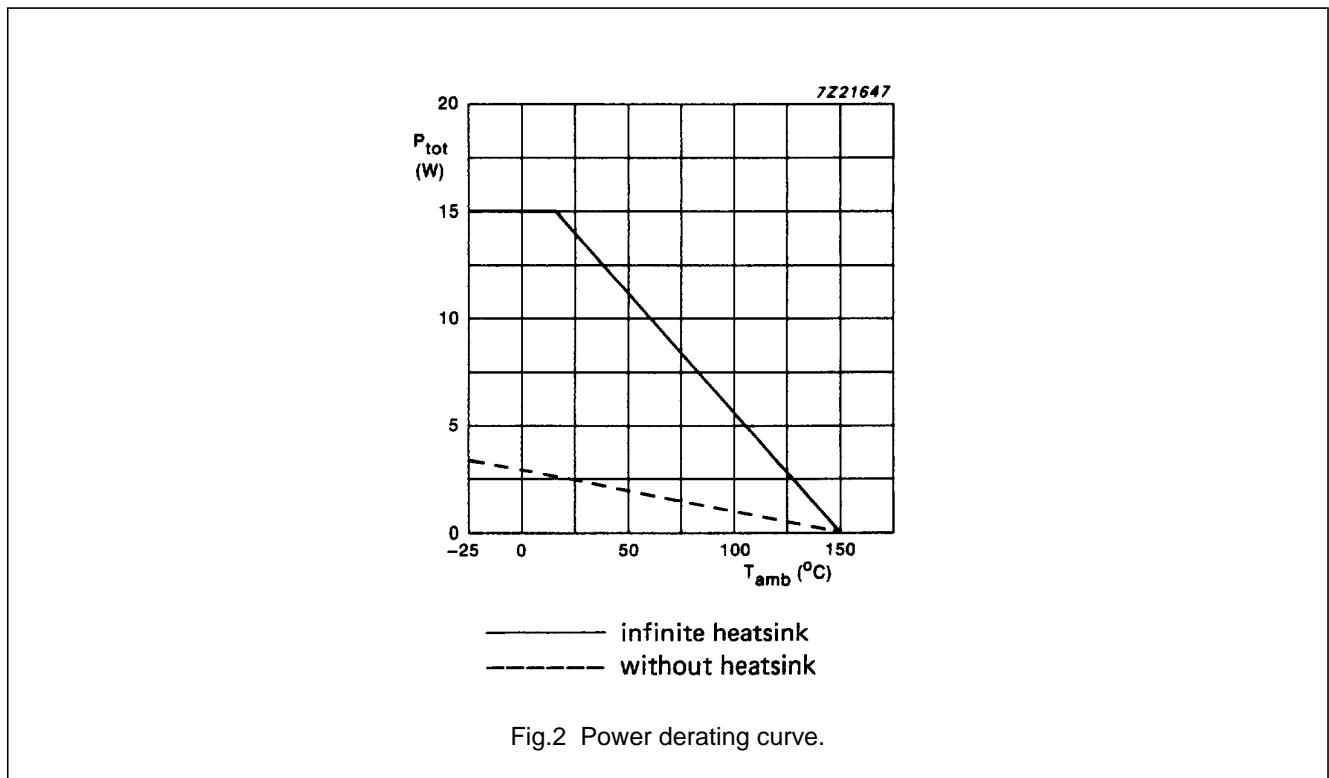

Fig.2 Power derating curve.

HEATSINK DESIGN EXAMPLE

Assume V_P = 18 V; R_L = 8 Ω; T_{amb} = 60 °C; T_C = 150 °C (max.); for a 4 W application, the maximum dissipation is approximately 2.5 W. The thermal resistance from junction to ambient can be expressed as:

$$R_{th\ j-a} = R_{th\ j-tab} + R_{th\ tab-h} + R_{th\ h-a} =$$

$$\frac{T_{j\ max} - T_{amb\ max}}{P_{max}} = \frac{150 - 60}{2.5} = 36\ K/W$$

Since R_{th j-tab} = 9 K/W and R_{th tab-h} = 1 K/W, R_{th h-a} = 36 – (9 + 1) = 26 K/W.

4 W audio power amplifier with DC volume control

TDA1013B

CHARACTERISTICS

$V_P = 18\text{ V}$; $R_L = 8\ \Omega$; $f = 1\text{ kHz}$; $T_{\text{amb}} = 25\text{ }^\circ\text{C}$; see Fig.10; unless otherwise specified

PARAMETER	CONDITIONS	SYMBOL	MIN.	TYP.	MAX.	UNIT
Supply voltage range		V_P	10	18	40	V
Total quiescent current		I_{tot}	–	25	60	mA
Noise output voltage	note 1					
at maximum gain	$R_S = 0\ \Omega$	V_n	–	0.5	–	mV
at maximum gain	$R_S = 5\ \text{k}\Omega$	V_n	–	0.6	1.4	mV
at minimum gain	$R_S = 0\ \Omega$	V_n	–	0.25	–	mV
Total sensitivity	$P_o = 2.5\text{ W}$; DC control at max. gain	V_i	44	55	69	mV
Audio amplifier						
Repetitive peak output current		I_{ORM}	–	–	1.5	A
Output power	THD = 10%; $R_L = 8\ \Omega$	P_o	4.0	4.2	–	W
Total harmonic distortion	$P_o = 2.5\text{ W}$; $R_L = 8\ \Omega$	THD	–	0.15	1.0	%
Sensitivity	$P_o = 2.5\text{ W}$	V_i	100	125	160	mV
Input impedance (pin 5)		$ Z_i $	100	200	500	k Ω
Power bandwidth		B_P	–	30 to 40 000	–	Hz
DC volume control unit						
Gain control range		$ \Delta G_V $	80	90	–	dB
Signal handling	THD < 1%; DC control = 0 dB	V_i	1.2	1.7	–	V
Sensitivity (pin 6)	$V_o = 125\text{ mV}$; max. voltage gain	V_i	39	44	55	mV
Input impedance (pin 8)		$ Z_i $	23	29	35	k Ω
Output impedance (pin 6)		$ Z_o $	45	60	75	Ω

Note to the characteristics

1. Measured in a bandwidth in accordance with IEC 179, curve 'A'.

4 W audio power amplifier with
DC volume control

TDA1013B

APPLICATION INFORMATION

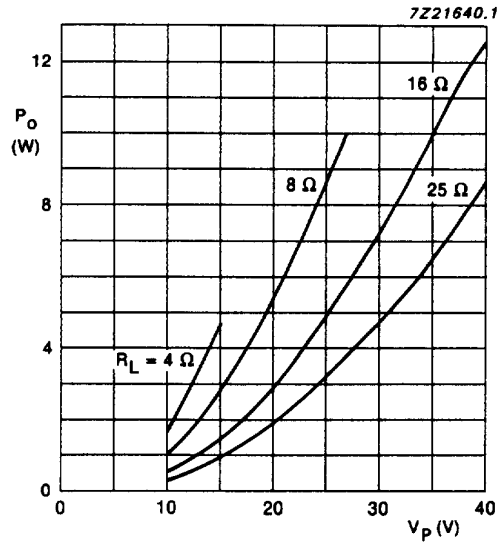

Fig.3 Output power as a function of supply voltage; $f = 1 \text{ kHz}$; THD = 10% and control voltage (V_7) = 6.5 V.

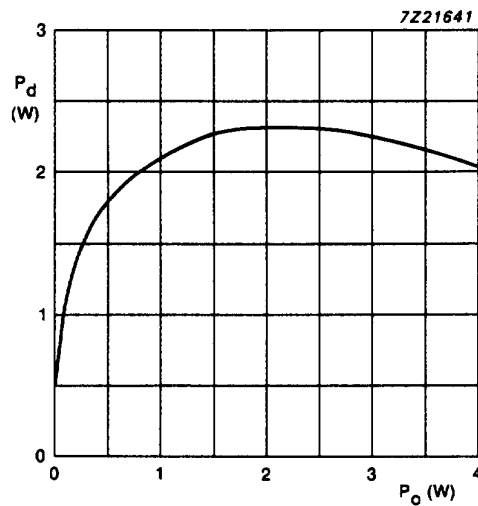

Fig.4 Power dissipation as a function of output power; $V_p = 18 \text{ V}$; $f = 1 \text{ kHz}$; $R_L = 8 \Omega$ and control voltage (V_7) = 6.5 V.

4 W audio power amplifier with
DC volume control

TDA1013B

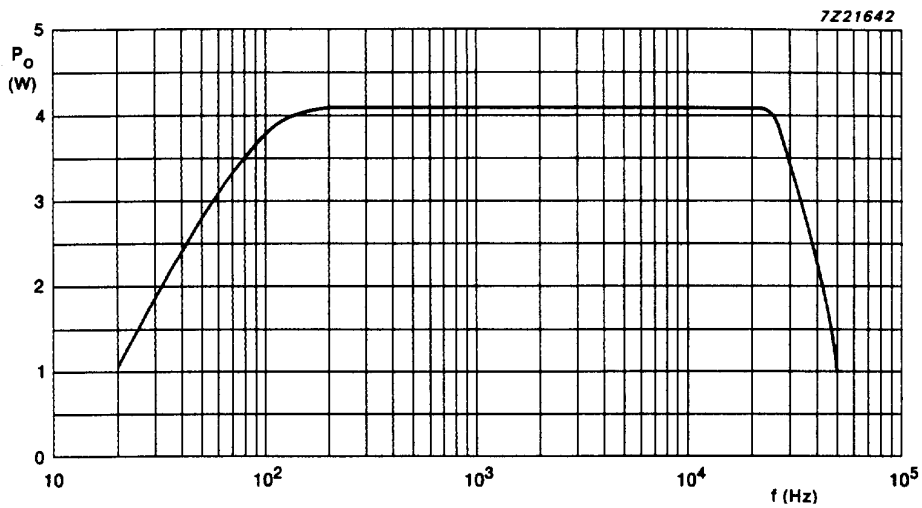

Fig.5 Power bandwidth; $V_P = 18\text{ V}$; $R_L = 8\ \Omega$; THD = 10% and control voltage (V_7) = 6.5 V.

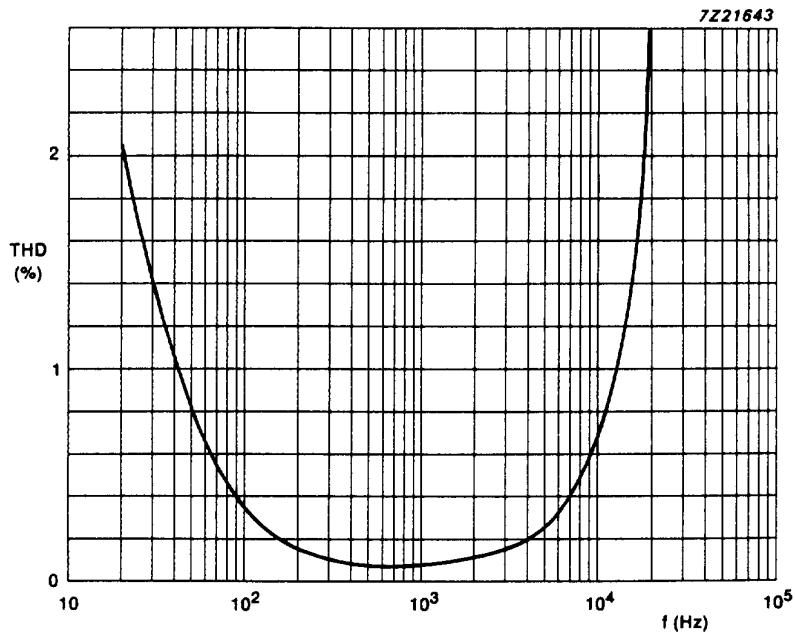

Fig.6 Total harmonic distortion as a function of frequency;
 $V_P = 18\text{ V}$; $R_L = 8\ \Omega$; $P_o = 2.5\text{ W}$ and control voltage = 6.5 V.

4 W audio power amplifier with DC volume control

TDA1013B

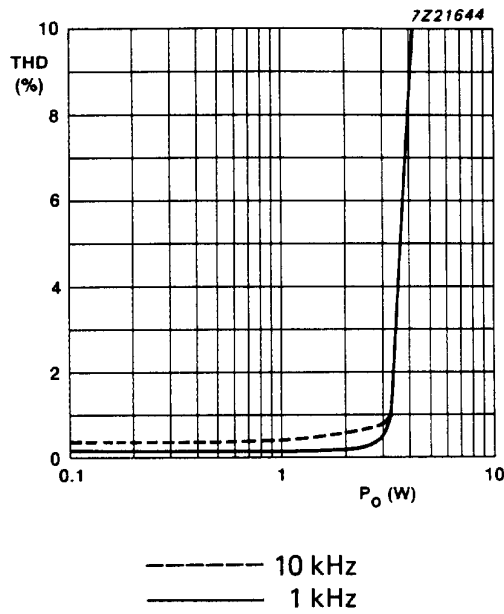

Fig.7 Total harmonic distortion as a function of output power; $V_P = 18$ V; $R_L = 8 \Omega$ and control voltage = 6.5 V.

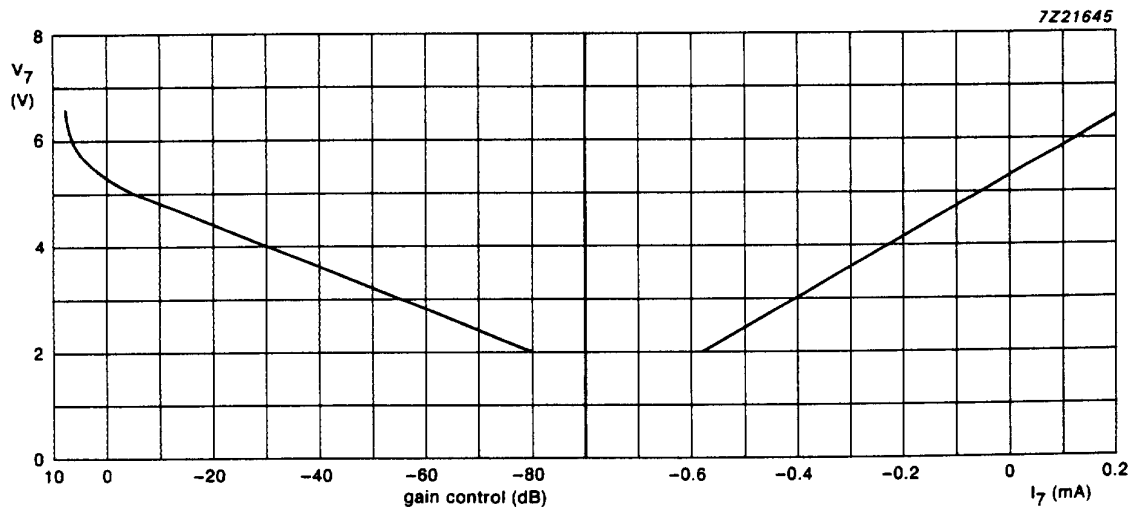

Fig.8 Typical control curve.

4 W audio power amplifier with DC volume control

TDA1013B

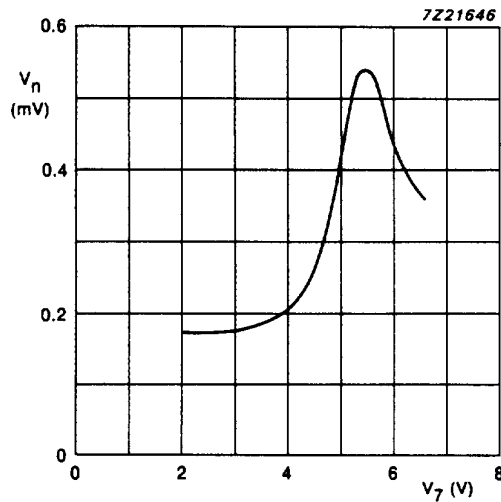
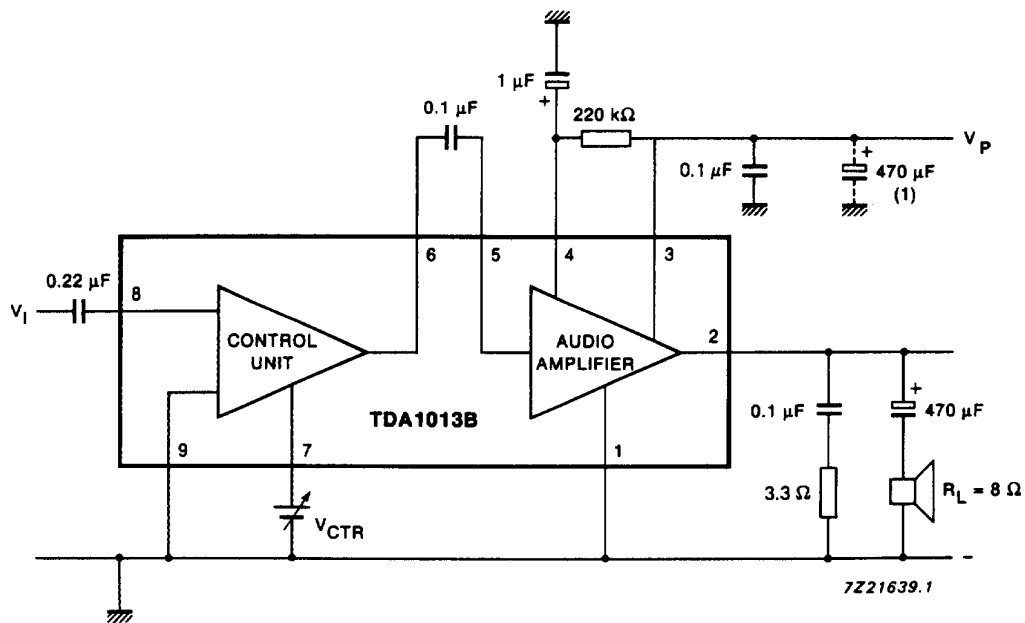

Fig.9 Noise output voltage as a function of the control voltage; $V_P = 18\text{ V}$; $R_L = 8\ \Omega$ (in accordance with IEC 179, curve 'A').



(1) Belongs to power supply circuitry.

Fig.10 Application diagram.

4 W audio power amplifier with DC volume control

TDA1013B

SOLDERING

Introduction

There is no soldering method that is ideal for all IC packages. Wave soldering is often preferred when through-hole and surface mounted components are mixed on one printed-circuit board. However, wave soldering is not always suitable for surface mounted ICs, or for printed-circuits with high population densities. In these situations reflow soldering is often used.

This text gives a very brief insight to a complex technology. A more in-depth account of soldering ICs can be found in our "IC Package Databook" (order code 9398 652 90011).

Soldering by dipping or by wave

The maximum permissible temperature of the solder is 260 °C; solder at this temperature must not be in contact with the joint for more than 5 seconds. The total contact time of successive solder waves must not exceed 5 seconds.

The device may be mounted up to the seating plane, but the temperature of the plastic body must not exceed the specified maximum storage temperature ($T_{stg\ max}$). If the printed-circuit board has been pre-heated, forced cooling may be necessary immediately after soldering to keep the temperature within the permissible limit.

Repairing soldered joints

Apply a low voltage soldering iron (less than 24 V) to the lead(s) of the package, below the seating plane or not more than 2 mm above it. If the temperature of the soldering iron bit is less than 300 °C it may remain in contact for up to 10 seconds. If the bit temperature is between 300 and 400 °C, contact may be up to 5 seconds.

DEFINITIONS

Data sheet status	
Objective specification	This data sheet contains target or goal specifications for product development.
Preliminary specification	This data sheet contains preliminary data; supplementary data may be published later.
Product specification	This data sheet contains final product specifications.
Limiting values	
Limiting values given are in accordance with the Absolute Maximum Rating System (IEC 134). Stress above one or more of the limiting values may cause permanent damage to the device. These are stress ratings only and operation of the device at these or at any other conditions above those given in the Characteristics sections of the specification is not implied. Exposure to limiting values for extended periods may affect device reliability.	
Application information	
Where application information is given, it is advisory and does not form part of the specification.	

LIFE SUPPORT APPLICATIONS

These products are not designed for use in life support appliances, devices, or systems where malfunction of these products can reasonably be expected to result in personal injury. Philips customers using or selling these products for use in such applications do so at their own risk and agree to fully indemnify Philips for any damages resulting from such improper use or sale.