

# BUL146G, BUL146FG

## SWITCHMODE™ NPN Bipolar Power Transistor For Switching Power Supply Applications

The BUL146G / BUL146FG have an applications specific state-of-the-art die designed for use in fluorescent electric lamp ballasts to 130 W and in Switchmode Power supplies for all types of electronic equipment.

### Features

- Improved Efficiency Due to Low Base Drive Requirements:
  - ◆ High and Flat DC Current Gain
  - ◆ Fast Switching
  - ◆ No Coil Required in Base Circuit for Turn-Off (No Current Tail)
- Full Characterization at 125°C
- Two Packages Choices: Standard TO-220 or Isolated TO-220
- Parametric Distributions are Tight and Consistent Lot-to-Lot
- BUL146F, Case 221D, is UL Recognized to 3500 V<sub>RMS</sub>: File # E69369
- These Devices are Pb-Free and are RoHS Compliant\*

### MAXIMUM RATINGS

Rating	Symbol	Value	Unit
Collector-Emitter Sustaining Voltage	V <sub>CEO</sub>	400	Vdc
Collector-Base Breakdown Voltage	V <sub>CES</sub>	700	Vdc
Emitter-Base Voltage	V <sub>EBO</sub>	9.0	Vdc
Collector Current	I <sub>C</sub>	6.0	Adc
	I <sub>CM</sub>	15	
Base Current	I <sub>B</sub>	4.0	Adc
	I <sub>BM</sub>	8.0	
RMS Isolation Voltage (Note 2) (for 1 sec, R.H. < 30%, T <sub>C</sub> = 25°C)	V <sub>ISOL1</sub> V <sub>ISOL2</sub> V <sub>ISOL3</sub>	<b>BUL146F</b> 4500 3500 1500	V
Total Device Dissipation @ T <sub>C</sub> = 25°C	P <sub>D</sub>		W
		BUL146	100
		BUL146F	40
Derate above 25°C		BUL146	0.8
		BUL146F	0.32
Operating and Storage Temperature	T <sub>J</sub> , T <sub>stg</sub>	-65 to 150	°C

### THERMAL CHARACTERISTICS

Characteristics	Symbol	Max	Unit
Thermal Resistance, Junction-to-Case	R <sub>θJC</sub>		°C/W
		BUL146	1.25
		BUL146F	3.125
Thermal Resistance, Junction-to-Ambient	R <sub>θJA</sub>	62.5	°C/W
Maximum Lead Temperature for Soldering Purposes 1/8" from Case for 5 Seconds	T <sub>L</sub>	260	°C

Stresses exceeding Maximum Ratings may damage the device. Maximum Ratings are stress ratings only. Functional operation above the Recommended Operating Conditions is not implied. Extended exposure to stresses above the Recommended Operating Conditions may affect device reliability.

1. Pulse Test: Pulse Width = 5 ms, Duty Cycle ≤ 10%.
2. Proper strike and creepage distance must be provided.



ON Semiconductor®

<http://onsemi.com>

**POWER TRANSISTOR**  
**8.0 AMPERES**  
**1000 VOLTS**  
**45 and 125 WATTS**

### MARKING DIAGRAMS

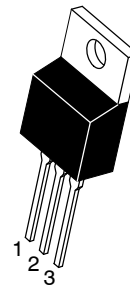

TO-220AB  
CASE 221A-09  
STYLE 1

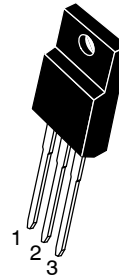

TO-220 FULLPACK  
CASE 221D  
STYLE 2  
UL RECOGNIZED

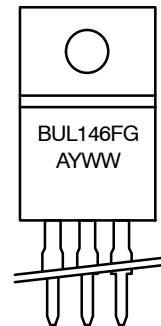

G = Pb-Free Package  
A = Assembly Location  
Y = Year  
WW = Work Week

### ORDERING INFORMATION

See detailed ordering and shipping information in the package dimensions section on page 8 of this data sheet.

\*For additional information on our Pb-Free strategy and soldering details, please download the ON Semiconductor Soldering and Mounting Techniques Reference Manual, SOLDERRM/D.

# BUL146G, BUL146FG

## ELECTRICAL CHARACTERISTICS ( $T_C = 25^\circ\text{C}$ unless otherwise noted)

Characteristic	Symbol	Min	Typ	Max	Unit
----------------	--------	-----	-----	-----	------

### OFF CHARACTERISTICS

Collector–Emitter Sustaining Voltage ( $I_C = 100\text{ mA}$ , $L = 25\text{ mH}$ )	$V_{CEO(sus)}$	400	–	–	Vdc
Collector Cutoff Current ( $V_{CE} = \text{Rated } V_{CEO}$ , $I_B = 0$ )	$I_{CEO}$	–	–	100	$\mu\text{Adc}$
Collector Cutoff Current ( $V_{CE} = \text{Rated } V_{CES}$ , $V_{EB} = 0$ )	$I_{CES}$	–	–	100	$\mu\text{Adc}$
				500	
				100	
Emitter Cutoff Current ( $V_{EB} = 9.0\text{ Vdc}$ , $I_C = 0$ )	$I_{EBO}$	–	–	100	$\mu\text{Adc}$

### ON CHARACTERISTICS

Base–Emitter Saturation Voltage ( $I_C = 1.3\text{ Adc}$ , $I_B = 0.13\text{ Adc}$ ) ( $I_C = 3.0\text{ Adc}$ , $I_B = 0.6\text{ Adc}$ )	$V_{BE(sat)}$	–	0.82 0.93	1.1 1.25	Vdc
Collector–Emitter Saturation Voltage ( $I_C = 1.3\text{ Adc}$ , $I_B = 0.13\text{ Adc}$ ) ( $T_C = 125^\circ\text{C}$ ) ( $I_C = 3.0\text{ Adc}$ , $I_B = 0.6\text{ Adc}$ ) ( $T_C = 125^\circ\text{C}$ )	$V_{CE(sat)}$	–	0.22 0.20 0.30 0.30	0.5 0.5 0.7 0.7	Vdc
DC Current Gain ( $I_C = 0.5\text{ Adc}$ , $V_{CE} = 5.0\text{ Vdc}$ ) ( $T_C = 125^\circ\text{C}$ ) ( $I_C = 1.3\text{ Adc}$ , $V_{CE} = 1.0\text{ Vdc}$ ) ( $T_C = 125^\circ\text{C}$ ) ( $I_C = 3.0\text{ Adc}$ , $V_{CE} = 1.0\text{ Vdc}$ ) ( $T_C = 125^\circ\text{C}$ ) ( $I_C = 10\text{ mAdc}$ , $V_{CE} = 5.0\text{ Vdc}$ )	$h_{FE}$	14	– 30 12 8.0 7.0 10	34 – – – – –	–

### DYNAMIC CHARACTERISTICS

Current Gain Bandwidth ( $I_C = 0.5\text{ Adc}$ , $V_{CE} = 10\text{ Vdc}$ , $f = 1.0\text{ MHz}$ )	$f_T$	–	14	–	MHz		
Output Capacitance ( $V_{CB} = 10\text{ Vdc}$ , $I_E = 0$ , $f = 1.0\text{ MHz}$ )	$C_{OB}$	–	95	150	pF		
Input Capacitance ( $V_{EB} = 8.0\text{ V}$ )	$C_{IB}$	–	1000	1500	pF		
Dynamic Saturation Voltage: Determined 1.0 $\mu\text{s}$ and 3.0 $\mu\text{s}$ respectively after rising $I_{B1}$ reaches 90% of final $I_{B1}$ (see Figure 18)	$I_C = 1.3\text{ Adc}$ $I_{B1} = 300\text{ mAdc}$ $V_{CC} = 300\text{ V}$	1.0 $\mu\text{s}$	$(T_C = 125^\circ\text{C})$	– –	2.5 6.5	– –	V
		3.0 $\mu\text{s}$	$(T_C = 125^\circ\text{C})$	– –	0.6 2.5	– –	
	$I_C = 3.0\text{ Adc}$ $I_{B1} = 0.6\text{ Adc}$ $V_{CC} = 300\text{ V}$	1.0 $\mu\text{s}$	$(T_C = 125^\circ\text{C})$	– –	3.0 7.0	– –	
		3.0 $\mu\text{s}$	$(T_C = 125^\circ\text{C})$	– –	0.75 1.4	– –	

# BUL146G, BUL146FG

## ELECTRICAL CHARACTERISTICS ( $T_C = 25^\circ\text{C}$ unless otherwise noted) (continued)

Characteristic	Symbol	Min	Typ	Max	Unit
----------------	--------	-----	-----	-----	------

### SWITCHING CHARACTERISTICS: Resistive Load (D.C. $\leq 10\%$ , Pulse Width = 20 $\mu\text{s}$ )

Turn-On Time	$(I_C = 1.3 \text{ Adc}, I_{B1} = 0.13 \text{ Adc}$ $I_{B2} = 0.65 \text{ Adc}, V_{CC} = 300 \text{ V})$ $(T_C = 125^\circ\text{C})$	$t_{on}$	–	100 90	200 –	ns
Turn-Off Time		$t_{off}$	–	1.35 1.90	2.5 –	$\mu\text{s}$
Turn-On Time	$(I_C = 3.0 \text{ Adc}, I_{B1} = 0.6 \text{ Adc}$ $I_{B1} = 1.5 \text{ Adc}, V_{CC} = 300 \text{ V})$ $(T_C = 125^\circ\text{C})$	$t_{on}$	–	90 100	150 –	ns
Turn-Off Time		$t_{off}$	–	1.7 2.1	2.5 –	$\mu\text{s}$

### SWITCHING CHARACTERISTICS: Inductive Load ( $V_{clamp} = 300 \text{ V}, V_{CC} = 15 \text{ V}, L = 200 \mu\text{H}$ )

Fall Time	$(I_C = 1.3 \text{ Adc}, I_{B1} = 0.13 \text{ Adc}$ $I_{B2} = 0.65 \text{ Adc})$ $(T_C = 125^\circ\text{C})$	$t_{fi}$	–	115 120	200 –	ns
Storage Time		$t_{si}$	–	1.35 1.75	2.5 –	$\mu\text{s}$
Crossover Time		$t_c$	–	200 210	350 –	ns
Fall Time	$(I_C = 3.0 \text{ Adc}, I_{B1} = 0.6 \text{ Adc}$ $I_{B2} = 1.5 \text{ Adc})$ $(T_C = 125^\circ\text{C})$	$t_{fi}$	–	85 100	150 –	ns
Storage Time		$t_{si}$	–	1.75 2.25	2.5 –	$\mu\text{s}$
Crossover Time		$t_c$	–	175 200	300 –	ns
Fall Time	$(I_C = 3.0 \text{ Adc}, I_{B1} = 0.6 \text{ Adc}$ $I_{B2} = 0.6 \text{ Adc})$ $(T_C = 125^\circ\text{C})$	$t_{fi}$	80 –	– 210	180 –	ns
Storage Time		$t_{si}$	2.6 –	– 4.5	3.8 –	$\mu\text{s}$
Crossover Time		$t_c$	–	230 400	350 –	ns

# BUL146G, BUL146FG

## TYPICAL STATIC CHARACTERISTICS

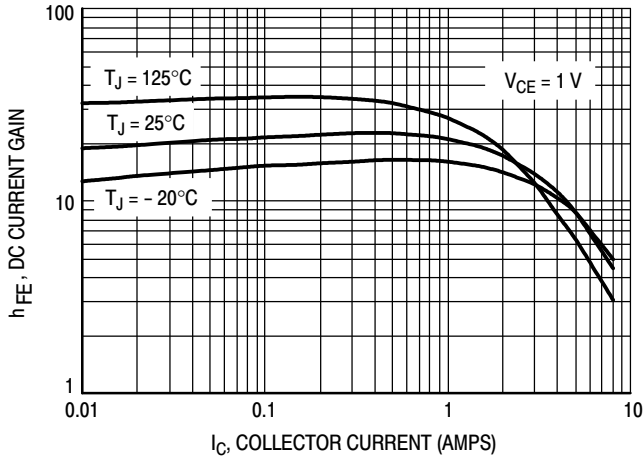

Figure 1. DC Current Gain @ 1 Volt

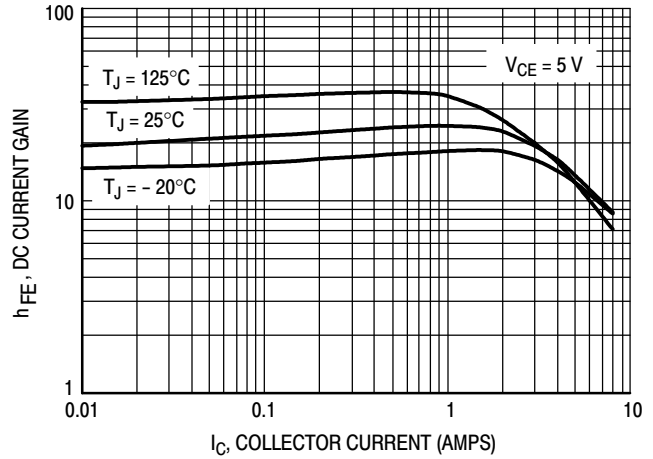

Figure 2. DC Current Gain @ 5 Volts

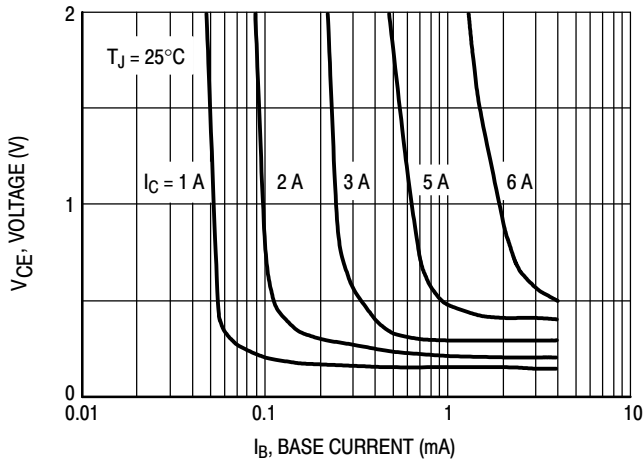

Figure 3. Collector Saturation Region

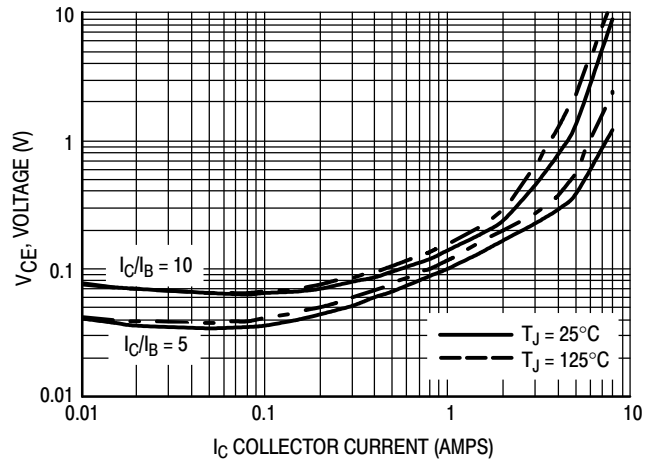

Figure 4. Collector-Emitter Saturation Voltage

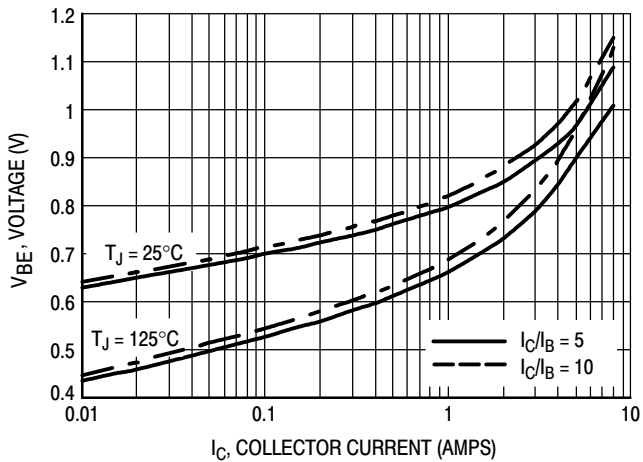

Figure 5. Base-Emitter Saturation Region

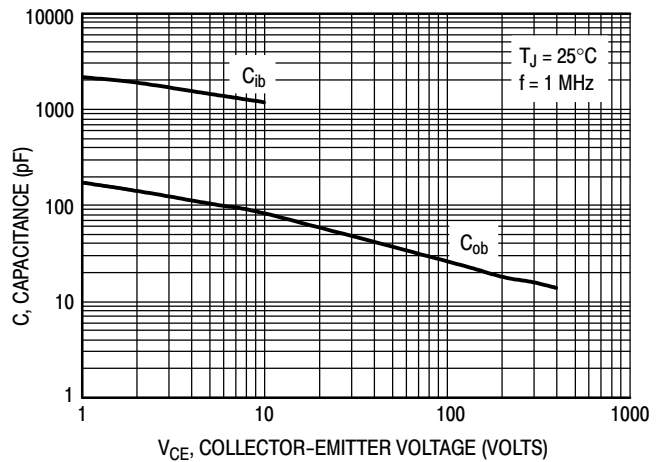

Figure 6. Capacitance

TYPICAL SWITCHING CHARACTERISTICS  
( $I_{B2} = I_C/2$  for all switching)

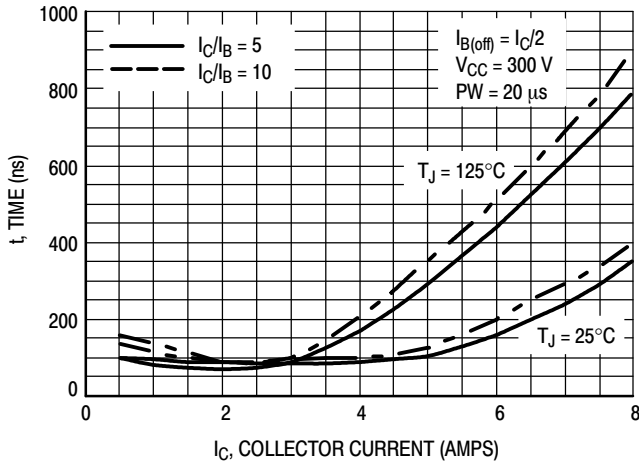

Figure 7. Resistive Switching,  $t_{on}$

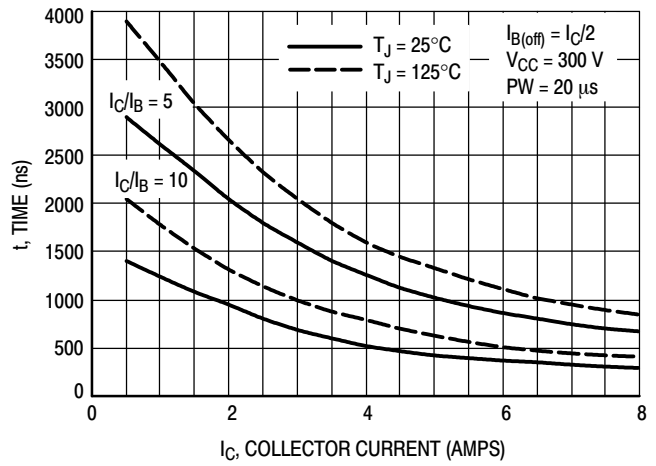

Figure 8. Resistive Switching,  $t_{off}$

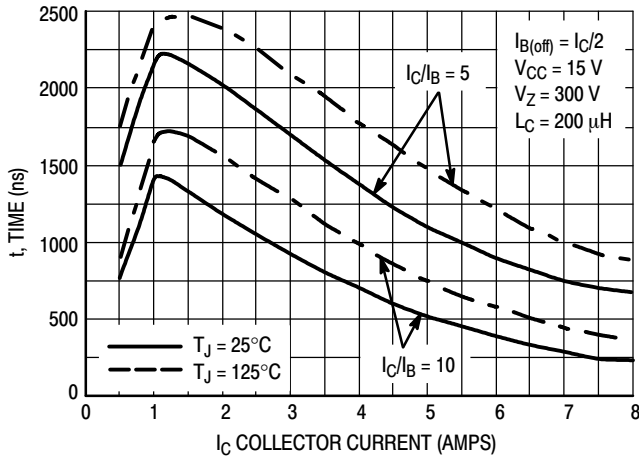

Figure 9. Inductive Storage Time,  $t_{si}$

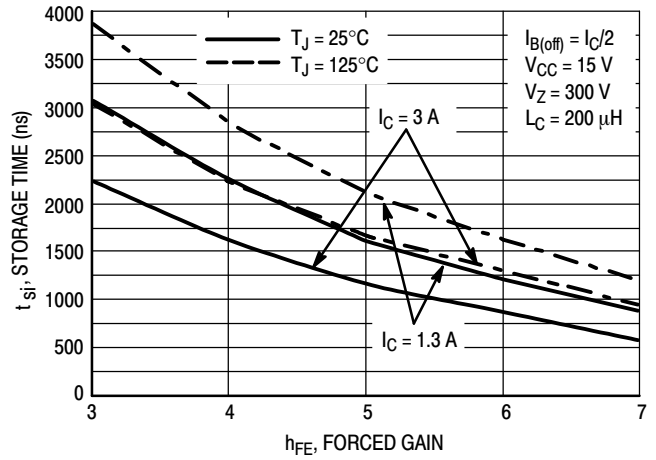

Figure 10. Inductive Storage Time,  $t_{si}(h_{FE})$

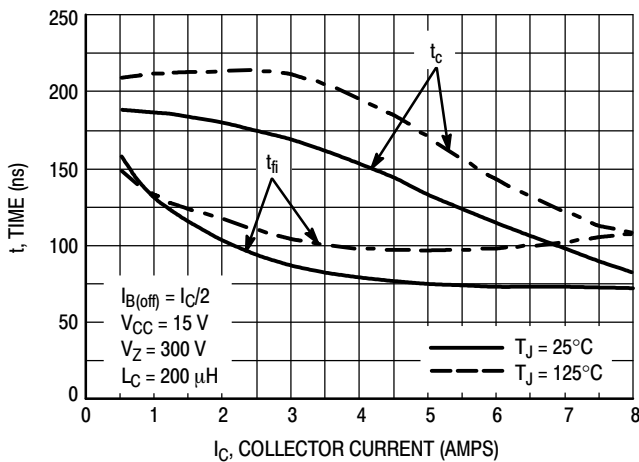

Figure 11. Inductive Switching,  $t_c$  and  $t_{fi}$   
 $I_C/I_B = 5$

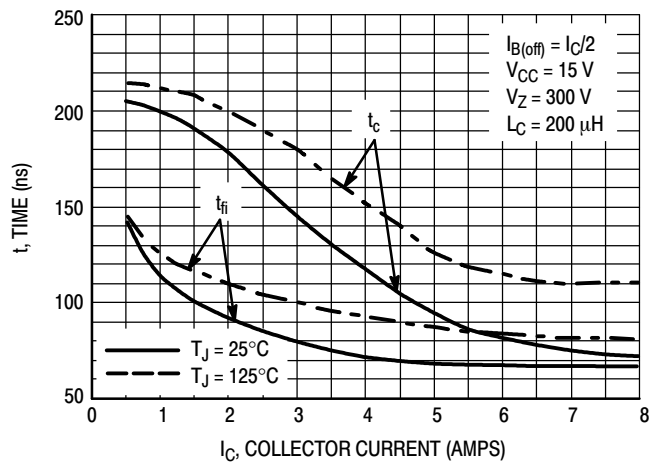

Figure 12. Inductive Switching,  $t_c$  and  $t_{fi}$   
 $I_C/I_B = 10$

# BUL146G, BUL146FG

## TYPICAL SWITCHING CHARACTERISTICS ( $I_{B2} = I_C/2$ for all switching)

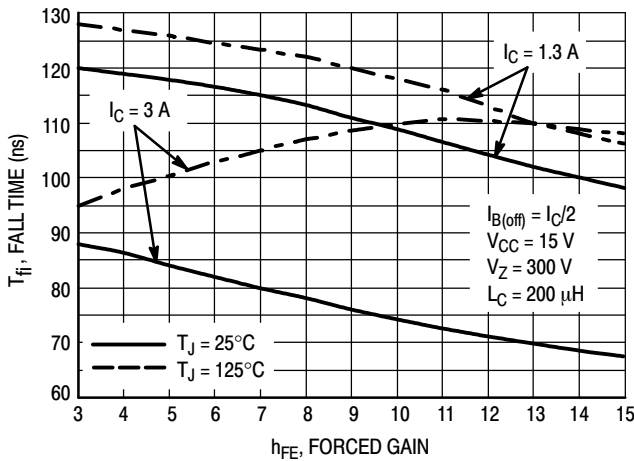

Figure 13. Inductive Fall Time

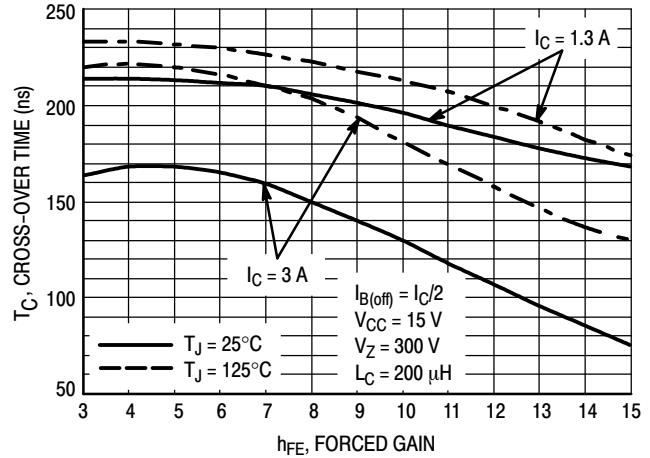

Figure 14. Inductive Cross-Over Time

## GUARANTEED SAFE OPERATING AREA INFORMATION

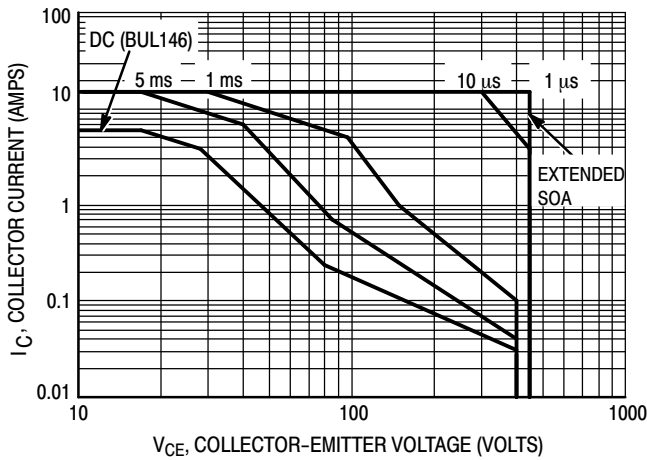

Figure 15. Forward Bias Safe Operating Area

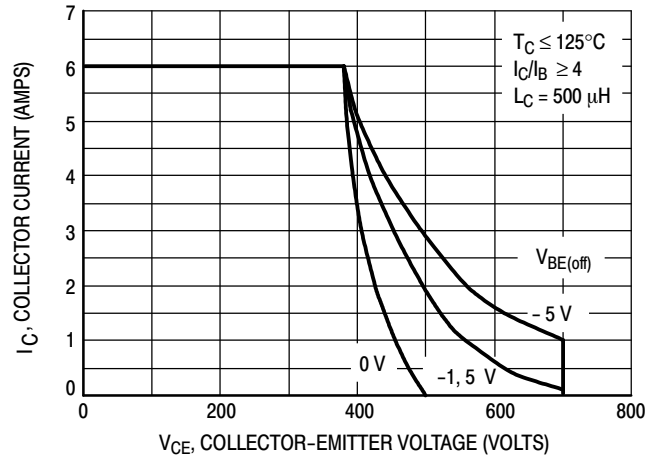

Figure 16. Reverse Bias Switching Safe Operating Area

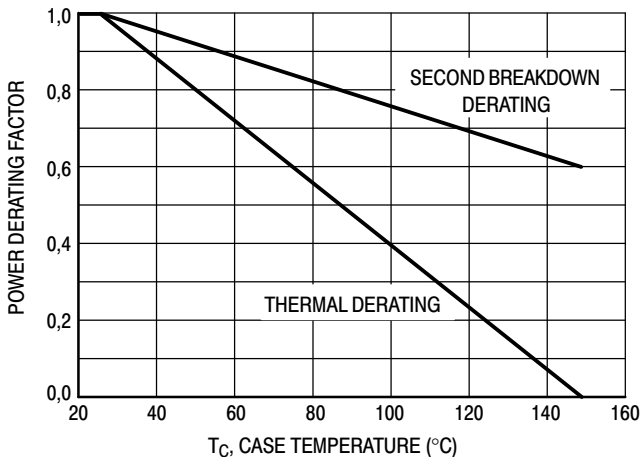

Figure 17. Forward Bias Power Derating

There are two limitations on the power handling ability of a transistor: average junction temperature and second breakdown. Safe operating area curves indicate  $I_C - V_{CE}$  limits of the transistor that must be observed for reliable operation; i.e., the transistor must not be subjected to greater dissipation than the curves indicate. The data of Figure 15 is based on  $T_C = 25^\circ\text{C}$ ;  $T_{J(pk)}$  is variable depending on power level. Second breakdown pulse limits are valid for duty cycles to 10% but must be derated when  $T_C > 25^\circ\text{C}$ . Second breakdown limitations do not derate the same as thermal limitations. Allowable current at the voltages shown in Figure 15 may be found at any case temperature by using the appropriate curve on Figure 17.  $T_{J(pk)}$  may be calculated from the data in Figure 20. At any case temperatures, thermal limitations will reduce the power that can be handled to values less than the limitations imposed by second breakdown. For inductive loads, high voltage and current must be sustained simultaneously during turn-off with the base-to-emitter junction reverse-biased. The safe level is specified as a reverse-biased safe operating area (Figure 16). This rating is verified under clamped conditions so that the device is never subjected to an avalanche mode.

# BUL146G, BUL146FG

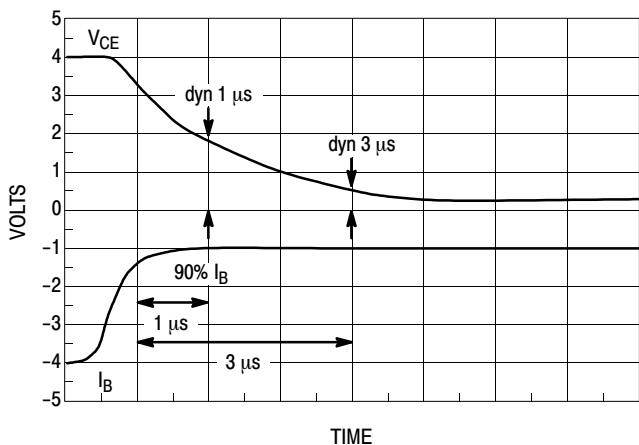

Figure 18. Dynamic Saturation Voltage Measurements

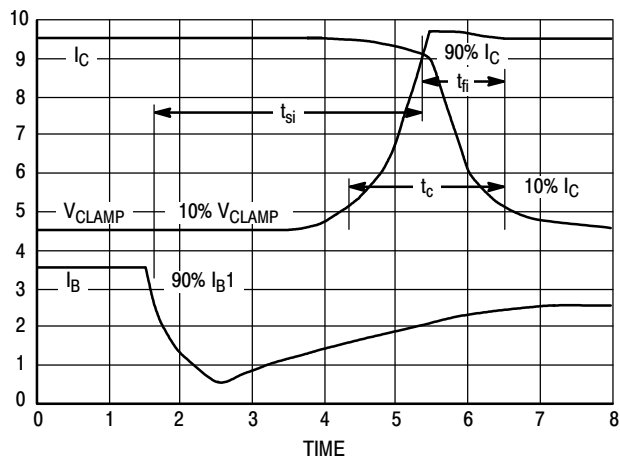
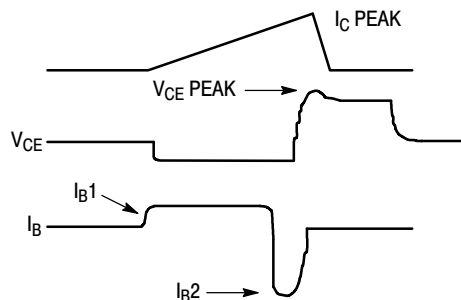
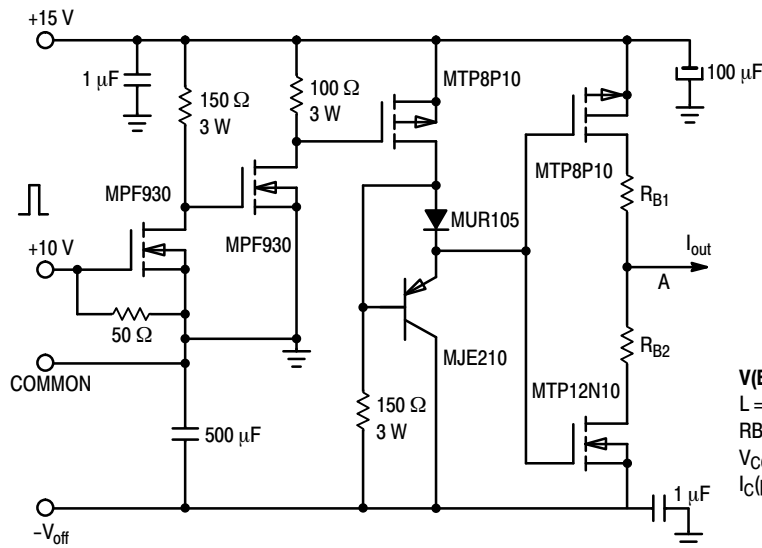

Figure 19. Inductive Switching Measurements



V(BR)CEO(sus)	INDUCTIVE SWITCHING	RBSOA
L = 10 mH	L = 200 μH	L = 500 μH
RB2 = ∞	RB2 = 0	RB2 = 0
VCC = 20 VOLTS	VCC = 15 VOLTS	VCC = 15 VOLTS
IC(pk) = 100 mA	RB1 SELECTED FOR DESIRED IB1	RB1 SELECTED FOR DESIRED IB1

Table 1. Inductive Load Switching Drive Circuit

# BUL146G, BUL146FG

## TYPICAL THERMAL RESPONSE

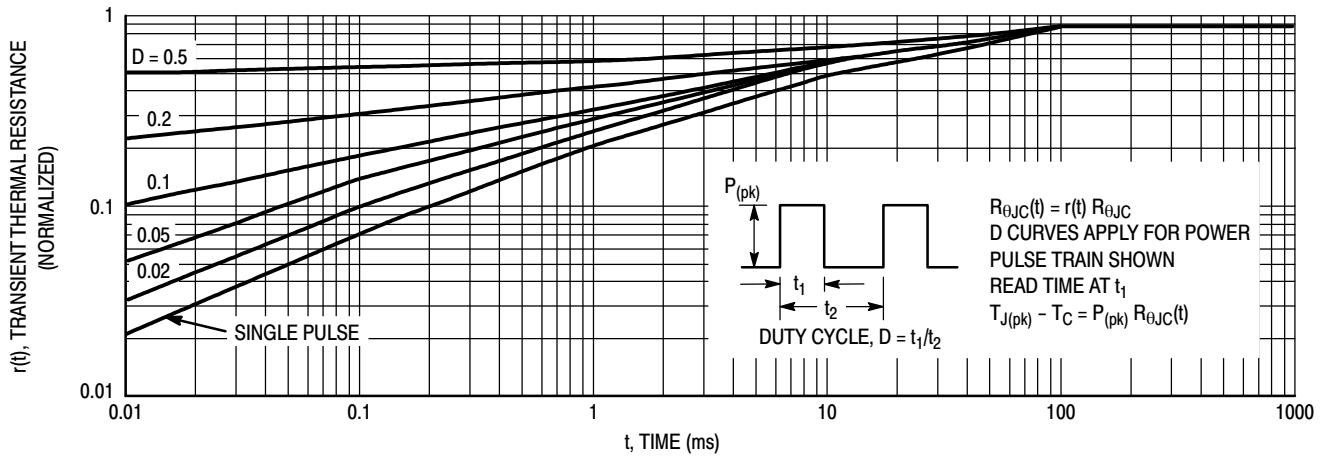

Figure 20. Typical Thermal Response ( $Z_{\theta_{JC}}(t)$ ) for BUL146

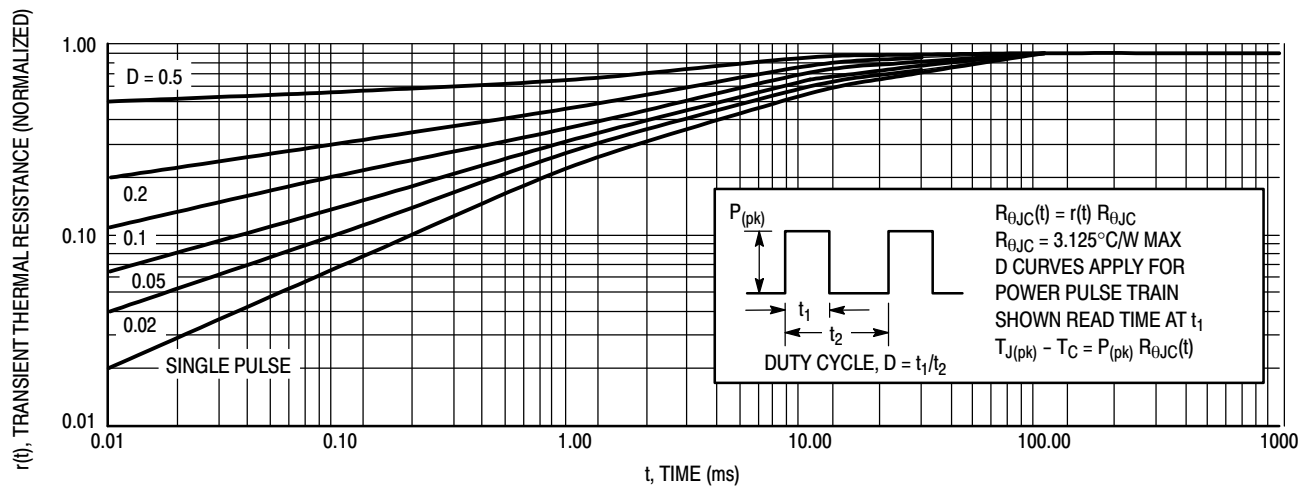

Figure 21. Typical Thermal Response for BUL146F

### ORDERING INFORMATION

Device	Package	Shipping
BUL146G	TO-220AB (Pb-Free)	50 Units / Rail
BUL146FG	TO-220 (Fullpack) (Pb-Free)	50 Units / Rail



# BUL146G, BUL146FG

## TEST CONDITIONS FOR ISOLATION TESTS\*

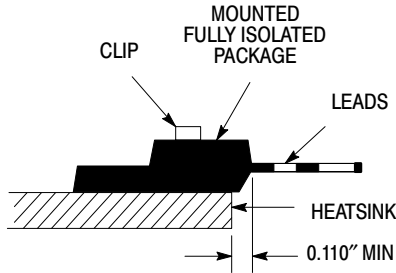

**Figure 22a. Screw or Clip Mounting Position for Isolation Test Number 1**

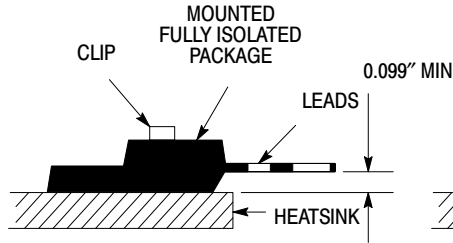

**Figure 22b. Clip Mounting Position for Isolation Test Number 2**

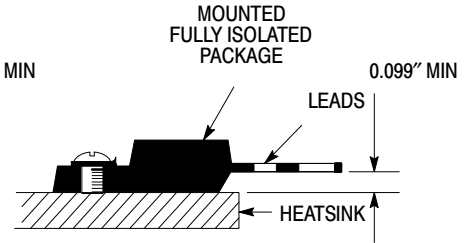

**Figure 22c. Screw Mounting Position for Isolation Test Number 3**

\*Measurement made between leads and heatsink with all leads shorted together

## MOUNTING INFORMATION\*\*

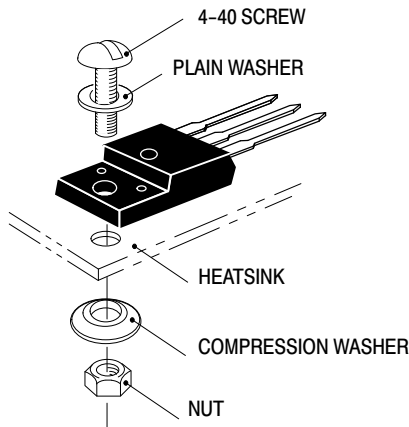

**Figure 23a. Screw-Mounted**

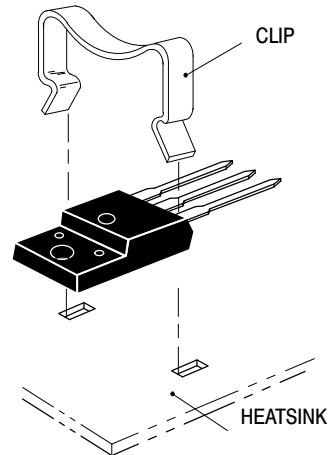

**Figure 23b. Clip-Mounted**

### Figure 23. Typical Mounting Techniques for Isolated Package

Laboratory tests on a limited number of samples indicate, when using the screw and compression washer mounting technique, a screw torque of 6 to 8 in · lbs is sufficient to provide maximum power dissipation capability. The compression washer helps to maintain a constant pressure on the package over time and during large temperature excursions.

Destructive laboratory tests show that using a hex head 4–40 screw, without washers, and applying a torque in excess of 20 in · lbs will cause the plastic to crack around the mounting hole, resulting in a loss of isolation capability.

Additional tests on slotted 4–40 screws indicate that the screw slot fails between 15 to 20 in · lbs without adversely affecting the package. However, in order to positively ensure the package integrity of the fully isolated device, ON Semiconductor does not recommend exceeding 10 in · lbs of mounting torque under any mounting conditions.

\*\* For more information about mounting power semiconductors see Application Note AN1040.

# BUL146G, BUL146FG

## PACKAGE DIMENSIONS

### TO-220AB CASE 221A-09 ISSUE AF

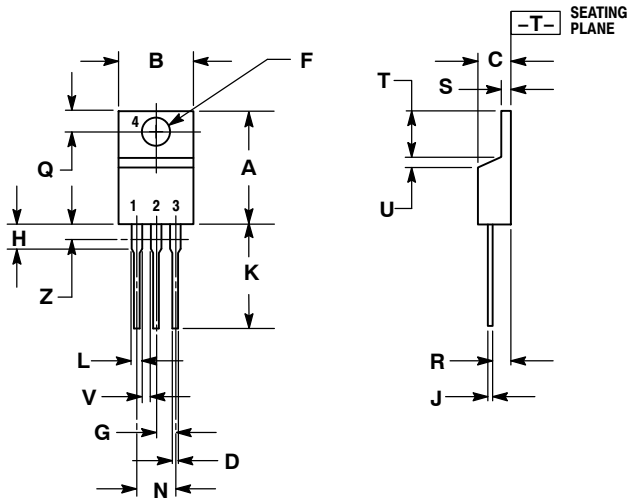

NOTES:

1. DIMENSIONING AND TOLERANCING PER ANSI Y14.5M, 1982.
2. CONTROLLING DIMENSION: INCH.
3. DIMENSION Z DEFINES A ZONE WHERE ALL BODY AND LEAD IRREGULARITIES ARE ALLOWED.

DIM	INCHES		MILLIMETERS	
	MIN	MAX	MIN	MAX
A	0.570	0.620	14.48	15.75
B	0.380	0.405	9.66	10.28
C	0.160	0.190	4.07	4.82
D	0.025	0.035	0.64	0.88
F	0.142	0.161	3.61	4.09
G	0.095	0.105	2.42	2.66
H	0.110	0.155	2.80	3.93
J	0.014	0.025	0.36	0.64
K	0.500	0.562	12.70	14.27
L	0.045	0.060	1.15	1.52
N	0.190	0.210	4.83	5.33
Q	0.100	0.120	2.54	3.04
R	0.080	0.110	2.04	2.79
S	0.045	0.055	1.15	1.39
T	0.235	0.255	5.97	6.47
U	0.000	0.050	0.00	1.27
V	0.045	---	1.15	---
Z	---	0.080	---	2.04

STYLE 1:

- PIN 1. BASE
2. COLLECTOR
3. EMITTER
4. COLLECTOR

### TO-220 FULLPAK CASE 221D-03 ISSUE G

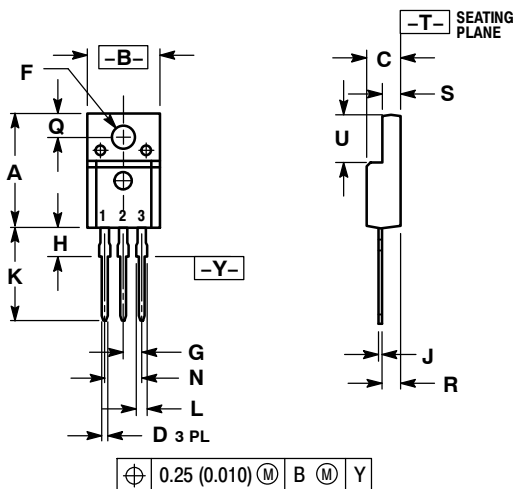

NOTES:

1. DIMENSIONING AND TOLERANCING PER ANSI Y14.5M, 1982.
2. CONTROLLING DIMENSION: INCH
3. 221D-01 THRU 221D-02 OBSOLETE, NEW STANDARD 221D-03.

DIM	INCHES		MILLIMETERS	
	MIN	MAX	MIN	MAX
A	0.625	0.635	15.88	16.12
B	0.408	0.418	10.37	10.63
C	0.180	0.190	4.57	4.83
D	0.026	0.031	0.65	0.78
F	0.116	0.119	2.95	3.02
G	0.100 BSC		2.54 BSC	
H	0.125	0.135	3.18	3.43
J	0.018	0.025	0.45	0.63
K	0.530	0.540	13.47	13.73
L	0.048	0.053	1.23	1.36
N	0.200 BSC		5.08 BSC	
Q	0.124	0.128	3.15	3.25
R	0.099	0.103	2.51	2.62
S	0.101	0.113	2.57	2.87
U	0.238	0.258	6.06	6.56

STYLE 2:

- PIN 1. BASE
2. COLLECTOR
3. EMITTER

# BUL146G, BUL146FG

SWITCHMODE is a trademark of Semiconductor Components Industries, LLC.

**ON Semiconductor** and **ON** are registered trademarks of Semiconductor Components Industries, LLC (SCILLC). SCILLC reserves the right to make changes without further notice to any products herein. SCILLC makes no warranty, representation or guarantee regarding the suitability of its products for any particular purpose, nor does SCILLC assume any liability arising out of the application or use of any product or circuit, and specifically disclaims any and all liability, including without limitation special, consequential or incidental damages. "Typical" parameters which may be provided in SCILLC data sheets and/or specifications can and do vary in different applications and actual performance may vary over time. All operating parameters, including "Typicals" must be validated for each customer application by customer's technical experts. SCILLC does not convey any license under its patent rights nor the rights of others. SCILLC products are not designed, intended, or authorized for use as components in systems intended for surgical implant into the body, or other applications intended to support or sustain life, or for any other application in which the failure of the SCILLC product could create a situation where personal injury or death may occur. Should Buyer purchase or use SCILLC products for any such unintended or unauthorized application, Buyer shall indemnify and hold SCILLC and its officers, employees, subsidiaries, affiliates, and distributors harmless against all claims, costs, damages, and expenses, and reasonable attorney fees arising out of, directly or indirectly, any claim of personal injury or death associated with such unintended or unauthorized use, even if such claim alleges that SCILLC was negligent regarding the design or manufacture of the part. SCILLC is an Equal Opportunity/Affirmative Action Employer. This literature is subject to all applicable copyright laws and is not for resale in any manner.

## PUBLICATION ORDERING INFORMATION

### LITERATURE FULFILLMENT:

Literature Distribution Center for ON Semiconductor  
P.O. Box 5163, Denver, Colorado 80217 USA  
**Phone:** 303-675-2175 or 800-344-3860 Toll Free USA/Canada  
**Fax:** 303-675-2176 or 800-344-3867 Toll Free USA/Canada  
**Email:** [orderlit@onsemi.com](mailto:orderlit@onsemi.com)

**N. American Technical Support:** 800-282-9855 Toll Free  
USA/Canada  
**Europe, Middle East and Africa Technical Support:**  
Phone: 421 33 790 2910  
**Japan Customer Focus Center**  
Phone: 81-3-5773-3850

**ON Semiconductor Website:** [www.onsemi.com](http://www.onsemi.com)

**Order Literature:** <http://www.onsemi.com/orderlit>

For additional information, please contact your local  
Sales Representative