

MJ14001 (PNP), MJ14002* (NPN), MJ14003* (PNP)

*Preferred Devices

High-Current Complementary Silicon Power Transistors

Designed for use in high-power amplifier and switching circuit applications.

Features

- High Current Capability – I_C Continuous = 60 Amperes
- DC Current Gain – $h_{FE} = 15-100$ @ $I_C = 50$ Adc
- Low Collector–Emitter Saturation Voltage – $V_{CE(sat)} = 2.5$ Vdc (Max) @ $I_C = 50$ Adc
- Pb–Free Packages are Available*

MAXIMUM RATINGS ($T_J = 25^\circ\text{C}$ unless otherwise noted)

Rating	Symbol	Value	Unit
Collector–Emitter Voltage MJ14001 MJ14002/03	V_{CEO}	60 80	Vdc
Collector–Base Voltage MJ14001 MJ14002/03	V_{CBO}	60 80	Vdc
Emitter–Base Voltage	V_{EBO}	5.0	Vdc
Collector Current – Continuous	I_C	60	Adc
Base Current – Continuous	I_B	15	Adc
Emitter Current – Continuous	I_E	75	Adc
Total Power Dissipation @ $T_C = 25^\circ\text{C}$ Derate Above 25°C	P_D	300 1.71	W W/ $^\circ\text{C}$
Operating and Storage Junction Temperature Range	T_J, T_{stg}	-65 to +200	$^\circ\text{C}$

Maximum ratings are those values beyond which device damage can occur. Maximum ratings applied to the device are individual stress limit values (not normal operating conditions) and are not valid simultaneously. If these limits are exceeded, device functional operation is not implied, damage may occur and reliability may be affected.

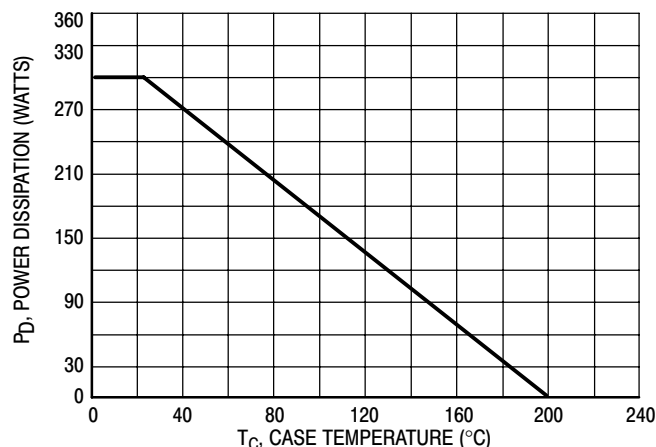

Figure 1. Power Derating



ON Semiconductor®

<http://onsemi.com>

60 AMPERE COMPLEMENTARY SILICON POWER TRANSISTORS 60–80 VOLTS, 300 WATTS

MARKING DIAGRAM

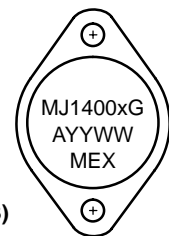
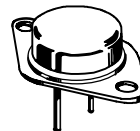

TO-204 (TO-3)
CASE 197A
STYLE 1

MJ1400x = Device Code
 xx = 1, 2, or 3
G = Pb–Free Package
A = Location Code
YY = Year
WW = Work Week
MEX = Country of Origin

ORDERING INFORMATION

Device	Package	Shipping
MJ14001	TO-3	100 Units/Tray
MJ14001G	TO-3 (Pb–Free)	100 Units/Tray
MJ14002	TO-3	100 Units/Tray
MJ14002G	TO-3 (Pb–Free)	100 Units/Tray
MJ14003	TO-3	100 Units/Tray
MJ14003G	TO-3 (Pb–Free)	100 Units/Tray

Preferred devices are recommended choices for future use and best overall value.

*For additional information on our Pb–Free strategy and soldering details, please download the ON Semiconductor Soldering and Mounting Techniques Reference Manual, SOLDERRM/D.

MJ14001 (PNP), MJ14002* (NPN), MJ14003* (PNP)

THERMAL CHARACTERISTICS

Characteristic	Symbol	Max	Unit
Thermal Resistance, Junction-to-Case	$R_{\theta JC}$	0.584	$^{\circ}C/W$

ELECTRICAL CHARACTERISTICS ($T_C = 25^{\circ}C$ unless otherwise noted)

Characteristic	Symbol	Min	Max	Unit
OFF CHARACTERISTICS				
Collector-Emitter Sustaining Voltage (Note 1) ($I_C = 200 \text{ mAdc}$, $I_B = 0$)	$V_{CE(sus)}$	60 80	– –	Vdc
Collector Cutoff Current ($V_{CE} = 30 \text{ Vdc}$, $I_B = 0$) ($V_{CE} = 40 \text{ Vdc}$, $I_B = 0$)	I_{CEO}	– –	1.0 1.0	mA
Collector Cutoff Current ($V_{CE} = 60 \text{ Vdc}$, $V_{BE(off)} = 1.5 \text{ V}$) ($V_{CE} = 80 \text{ Vdc}$, $V_{BE(off)} = 1.5 \text{ V}$)	I_{CEX}	– –	1.0 1.0	mA
Collector Cutoff Current ($V_{CB} = 60 \text{ Vdc}$, $I_E = 0$) ($V_{CB} = 80 \text{ Vdc}$, $I_E = 0$)	I_{CBO}	– –	1.0 1.0	mA
Emitter Cutoff Current ($V_{BE} = 5.0 \text{ Vdc}$, $I_C = 0$)	I_{EBO}	–	1.0	mA

ON CHARACTERISTICS

DC Current Gain (Note 1) ($I_C = 25 \text{ Adc}$, $V_{CE} = 3.0 \text{ V}$) ($I_C = 50 \text{ Adc}$, $V_{CE} = 3.0 \text{ V}$) ($I_C = 60 \text{ Adc}$, $V_{CE} = 3.0 \text{ V}$)	h_{FE}	30 15 5.0	– 100 –	–
Collector-Emitter Saturation Voltage (Note 1) ($I_C = 25 \text{ Adc}$, $I_B = 2.5 \text{ Adc}$) ($I_C = 50 \text{ Adc}$, $I_B = 5.0 \text{ Adc}$) ($I_C = 60 \text{ Adc}$, $I_B = 12 \text{ Adc}$)	$V_{CE(sat)}$	– – –	1.0 2.5 3.0	Vdc
Base-Emitter Saturation Voltage (Note 1) ($I_C = 25 \text{ Adc}$, $I_B = 2.5 \text{ Adc}$) ($I_C = 50 \text{ Adc}$, $I_B = 5.0 \text{ Adc}$) ($I_C = 60 \text{ Adc}$, $I_B = 12 \text{ Adc}$)	$V_{BE(sat)}$	– – –	2.0 3.0 4.0	Vdc

DYNAMIC CHARACTERISTICS

Output Capacitance ($V_{CB} = 10 \text{ Vdc}$, $I_E = 0$, $f = 0.1 \text{ MHz}$)	C_{ob}	–	2000	pF
---	----------	---	------	----

1. Pulse Test: Pulse Width $\leq 300 \mu s$, Duty Cycle $\leq 2.0\%$.

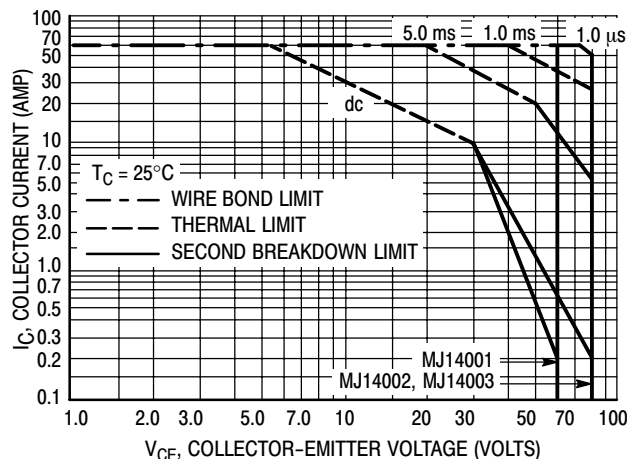

Figure 2. Maximum Rated Forward Biased Safe Operating Area

There are two limitations on the power handling ability of a transistor: average junction temperature and second breakdown. Safe operating area curves indicate $I_C - V_{CE}$ limits of the transistor that must be observed for reliable operation: i.e., the transistor must not be subjected to greater dissipation than the curves indicate.

The data of Figure 2 is based on $T_{J(pk)} = 200^{\circ}C$; T_C is variable depending on conditions. Second breakdown pulse limits are valid for duty cycles to 10% provided $T_{J(pk)} \leq 200^{\circ}C$. $T_{J(pk)}$ may be calculated from the data in Figure 13. At high case temperatures, thermal limitations will reduce the power that can be handled to values less than the limitations imposed by second breakdown.

MJ14001 (PNP), MJ14002* (NPN), MJ14003* (PNP)

TYPICAL ELECTRICAL CHARACTERISTICS

MJ14002 (NPN)

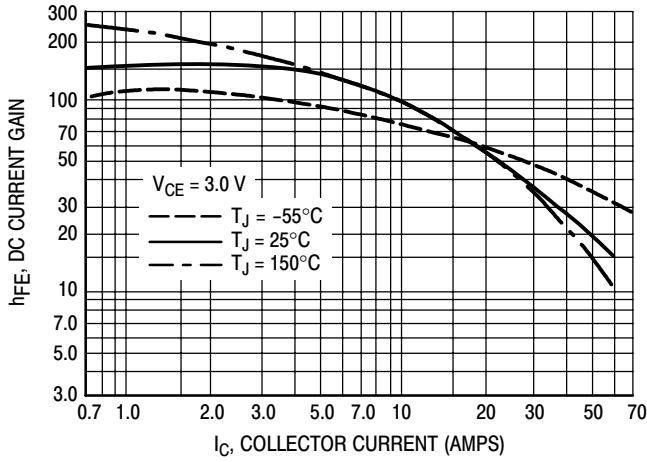

Figure 3. DC Current Gain

MJ14001, MJ14003 (PNP)

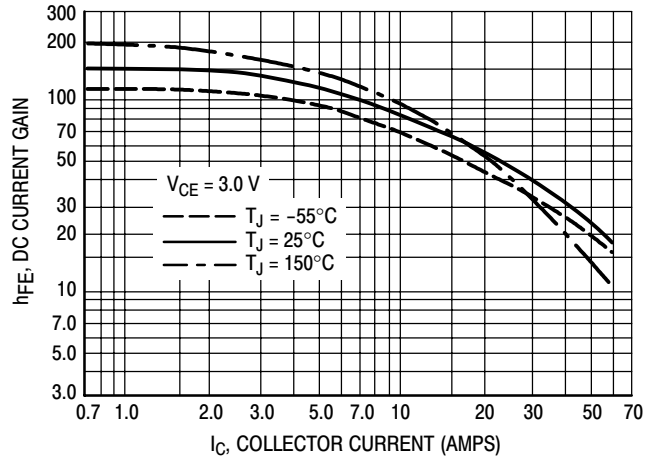

Figure 4. DC Current Gain

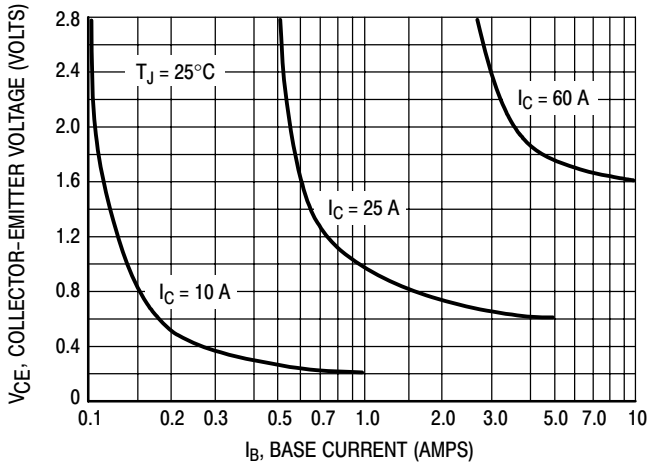

Figure 5. Collector Saturation Region

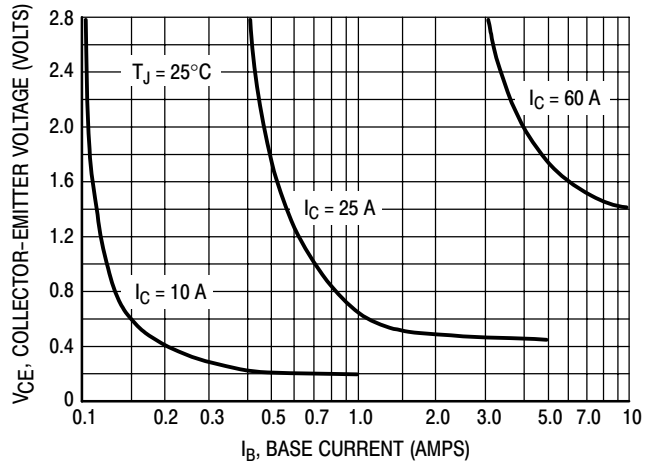

Figure 6. Collector Saturation Region

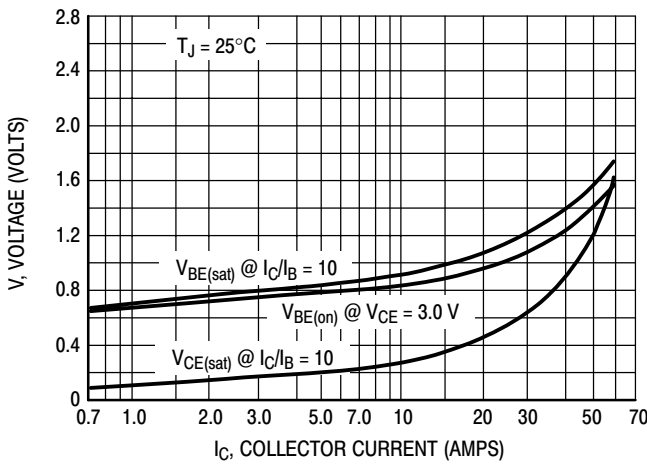

Figure 7. "On" Voltages

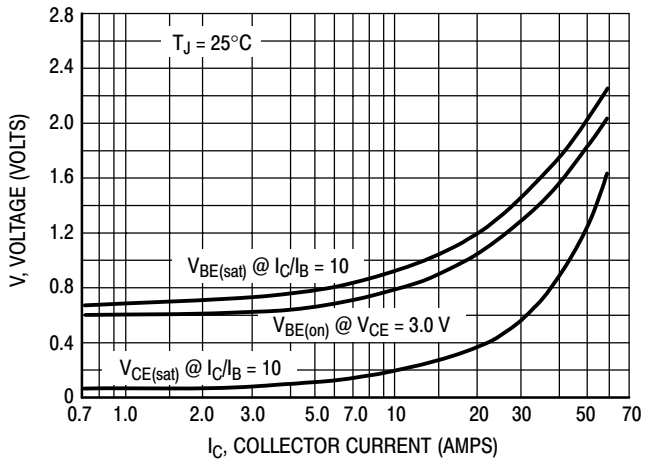

Figure 8. "On" Voltages

MJ14001 (PNP), MJ14002* (NPN), MJ14003* (PNP)

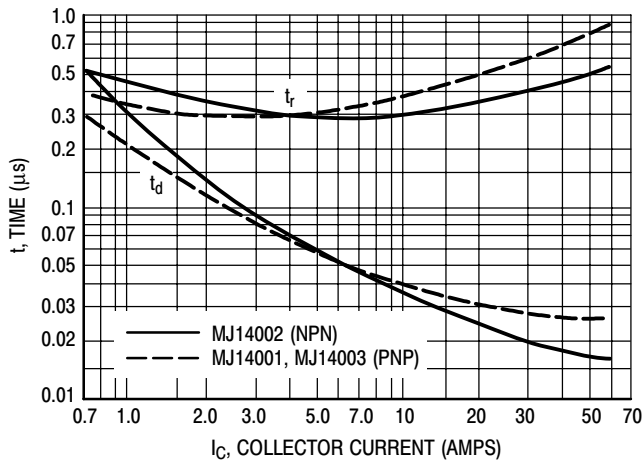

Figure 9. Turn-On Switching Times

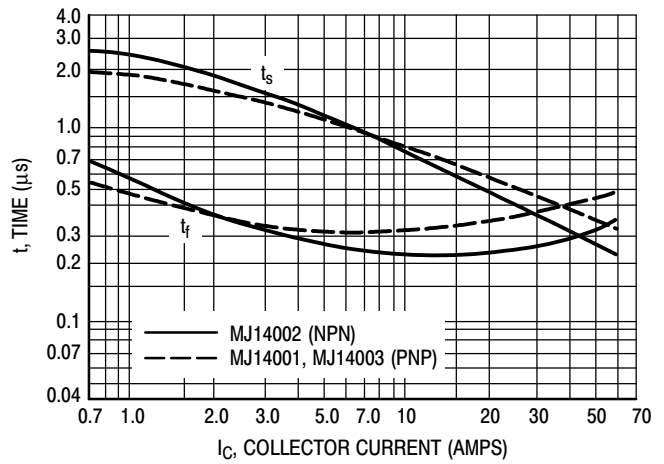

Figure 10. Turn-Off Switching Times

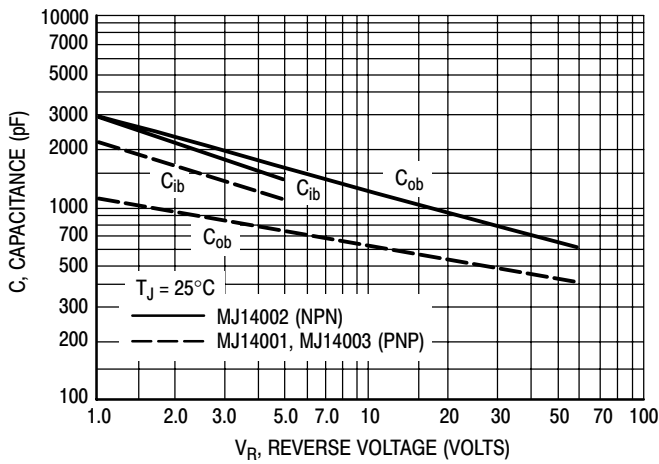
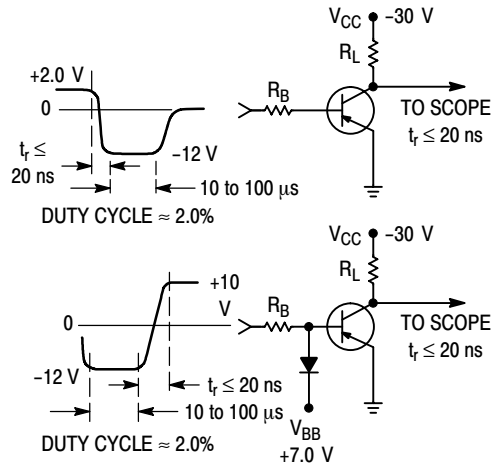

Figure 11. Capacitance Variation



FOR CURVES OF FIGURES 3 & 6, R_B & R_L ARE VARIED. INPUT LEVELS ARE APPROXIMATELY AS SHOWN. FOR NPN CIRCUITS, REVERSE ALL POLARITIES.

Figure 12. Switching Test Circuit

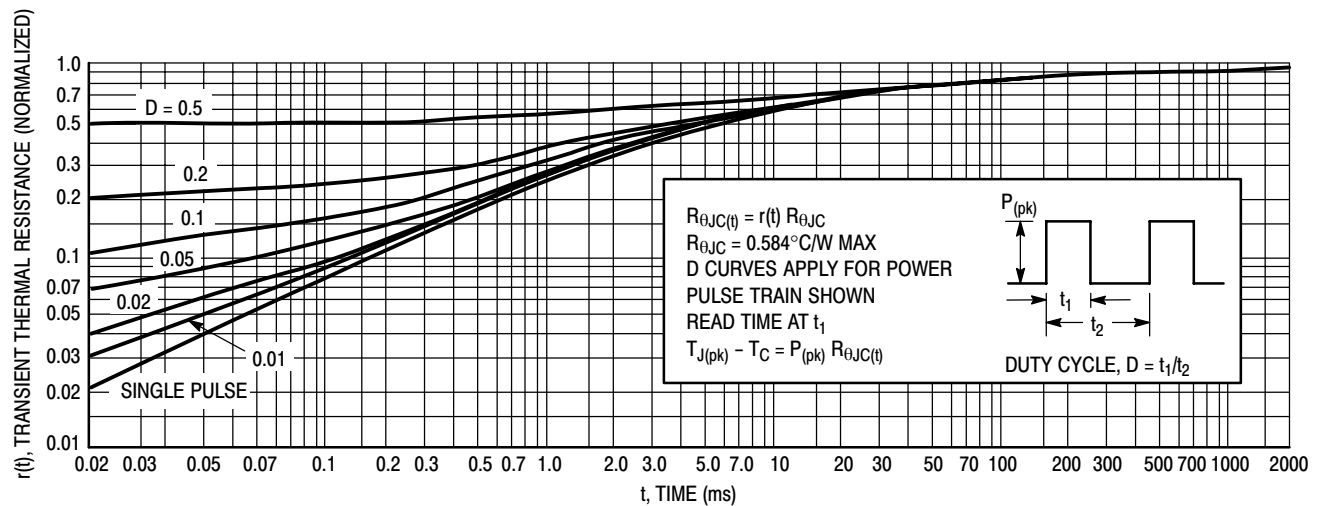
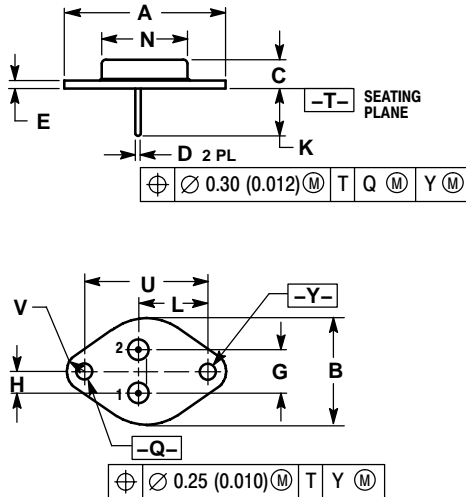

Figure 13. Thermal Response

MJ14001 (PNP), MJ14002* (NPN), MJ14003* (PNP)

PACKAGE DIMENSIONS

TO-204 (TO-3)
CASE 197A-05
ISSUE K



- NOTES:
1. DIMENSIONING AND TOLERANCING PER ANSI Y14.5M, 1982.
2. CONTROLLING DIMENSION: INCH.

DIM	INCHES		MILLIMETERS	
	MIN	MAX	MIN	MAX
A	1.530	REF	38.86	REF
B	0.990	1.050	25.15	26.67
C	0.250	0.335	6.35	8.51
D	0.057	0.063	1.45	1.60
E	0.060	0.070	1.53	1.77
G	0.430	BSC	10.92	BSC
H	0.215	BSC	5.46	BSC
K	0.440	0.480	11.18	12.19
L	0.665	BSC	16.89	BSC
N	0.760	0.830	19.31	21.08
Q	0.151	0.165	3.84	4.19
U	1.187	BSC	30.15	BSC
V	0.131	0.188	3.33	4.77

STYLE 1:
PIN 1. BASE
2. EMITTER
CASE: COLLECTOR

ON Semiconductor and are registered trademarks of Semiconductor Components Industries, LLC (SCILLC). SCILLC reserves the right to make changes without further notice to any products herein. SCILLC makes no warranty, representation or guarantee regarding the suitability of its products for any particular purpose, nor does SCILLC assume any liability arising out of the application or use of any product or circuit, and specifically disclaims any and all liability, including without limitation special, consequential or incidental damages. "Typical" parameters which may be provided in SCILLC data sheets and/or specifications can and do vary in different applications and actual performance may vary over time. All operating parameters, including "Typicals" must be validated for each customer application by customer's technical experts. SCILLC does not convey any license under its patent rights nor the rights of others. SCILLC products are not designed, intended, or authorized for use as components in systems intended for surgical implant into the body, or other applications intended to support or sustain life, or for any other application in which the failure of the SCILLC product could create a situation where personal injury or death may occur. Should Buyer purchase or use SCILLC products for any such unintended or unauthorized application, Buyer shall indemnify and hold SCILLC and its officers, employees, subsidiaries, affiliates, and distributors harmless against all claims, costs, damages, and expenses, and reasonable attorney fees arising out of, directly or indirectly, any claim of personal injury or death associated with such unintended or unauthorized use, even if such claim alleges that SCILLC was negligent regarding the design or manufacture of the part. SCILLC is an Equal Opportunity/Affirmative Action Employer. This literature is subject to all applicable copyright laws and is not for resale in any manner.

PUBLICATION ORDERING INFORMATION

LITERATURE FULFILLMENT:
Literature Distribution Center for ON Semiconductor
P.O. Box 61312, Phoenix, Arizona 85082-1312 USA
Phone: 480-829-7710 or 800-344-3860 Toll Free USA/Canada
Fax: 480-829-7709 or 800-344-3867 Toll Free USA/Canada
Email: orderlit@onsemi.com

N. American Technical Support: 800-282-9855 Toll Free USA/Canada

Japan: ON Semiconductor, Japan Customer Focus Center
2-9-1 Kamimeguro, Meguro-ku, Tokyo, Japan 153-0051
Phone: 81-3-5773-3850

ON Semiconductor Website: <http://onsemi.com>

Order Literature: <http://www.onsemi.com/litorder>

For additional information, please contact your local Sales Representative.